

ComPoint™

The music lover's intercom solution

Instruction Manual

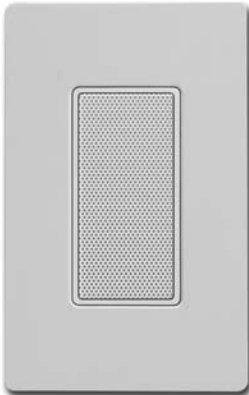

SAFETY PRECAUTIONS

1. Read these instructions.
2. Keep these instructions.
3. Heed all warnings.
4. Follow all instructions.
5. Do not use this apparatus near water.
6. Clean only with dry cloth.
7. Do not block any ventilation openings. Install in accordance with the manufacturer's instructions.
8. Do not install near any heat sources such as radiators, heat registers, stoves, or other apparatus (including amplifiers) that produce heat.
9. Do not defeat the safety purpose of the polarized or grounding plug. A polarized plug has two blades with one wider than the other. A grounding plug has two blades and a third grounding prong. The wide blade or the third prong is provided for your safety. If the provided plug does not fit into your outlet, consult an electrician for replacement of the obsolete outlet.
10. Protect the power cord from being walked on or pinched, particularly at plugs, convenience receptacles, and the point where it exits from the apparatus.
11. Use only attachments or accessories specified by the manufacturer.
12. Use only with the cart, stand, tripod, bracket, or table specified by the manufacturer or sold with the apparatus. When a cart is used, use caution when moving the cart-apparatus combination to avoid injury from tip-over.
13. Unplug this apparatus during lightning storms or when unused for long periods of time.
14. Refer all servicing to qualified service personnel. Servicing is required when the apparatus has been damaged in any way, such as the power supply cord or plug is damaged, liquid has been spilled or objects have fallen into the apparatus, or the apparatus has been exposed to rain or moisture, does not operate normally, or has been dropped.

If you have any questions, call Russound at 800.638.8055 or 603.659.5170.





USER SECTION		Programming	21–27
Welcome to ComPoint™	4	Overview	21
About this manual	5	Doorbell chimes	22
What's in your ComPoint system	6–8	Hub ID numbers	22
Using your ComPoint system	9–15	Zone and door station labels	23
Things you'll need to know	9	Assigning zone labels	24
Paging	9	Assigning door station labels	25
Intercom	10	Viewing system information	25
Door station call	11	Restoring factory settings	25
Door strike release	12	Programming flow charts	26–27
Listen mode	13	Detailed function descriptions	28–31
Do Not Disturb mode	14	Communication priority levels	28
Combined Listen and DND modes	15	Paging	28
		Intercom	28
		Door station call	29
		Door strike release	30
		Listen mode	30
		Audible keypad volume level indication	31
		System busy	31
		Do Not Disturb (DND) mode	31
		Keypad backlight	31
		System function test	32
		Troubleshooting chart	33
INSTALLER SECTION		REFERENCE SECTION	
About this section	16	Technical specifications	34
Product summary	16–18	Warranty	35
ISH1 Hub	17		
System keypads	17		
ISK1 Basic Keypad	17		
ISK2 Advanced Keypad	17		
ISK3 Door Station	18		
ISDR1 Door Strike Release Module	18		
Keypad backlight color selection	18		
Device installation and trim	19		
Wiring and connections	19–21		
110 punch-down connections	19		
Speaker connections	20		
Hub modular connections	20		
Doorbell connections	20		
Door strike release connections	21		

USER SECTION

Introduction

Welcome to ComPoint™

Thank you for choosing a Russound ComPoint system for your home or business. While you may already be familiar with paging and intercom systems, each system works differently. We've designed ComPoint for ease of operation and with a unique set of capabilities to meet your communication needs. You'll be pleased with the way the system simplifies your life, and we're confident you'll enjoy using ComPoint every day.

ComPoint integrates the following features:

System-wide paging

Perhaps you want to call the family to dinner, move your party guests to the living room, or summon everyone in the office to an important meeting. ComPoint's paging feature allows you to do all this with ease.

You can let everybody know about an important event like a birthday or anniversary, or you can broadcast a message for someone to pick up the phone or come see you. Whatever announcement you want to make throughout your home or business, paging allows you to get the word out. What's more, if you're paging an individual, that person can reply to your page from the nearest keypad.

Point-to-point intercom

One of ComPoint's most useful functions is the intercom feature. You need to talk with

someone in another room out of earshot, and you can't leave the room you're in. The solution? The intercom feature lets you contact the person directly, saving you steps and time.

Whenever you want to reach a particular person without disturbing the whole house or office, the intercom feature connects you to the room the person is in. You can think of an intercom session as a private conversation while paging is a public announcement. Also, intercom enables two-way conversations, whereas paging is intended for one-way communication.

Door station call and reply

With ComPoint at your service, you don't have to run to the door every time the doorbell rings. If you can't get to the door right away, the door station call function gives you the convenience of answering the door from any room.

At any keypad you can have a two-way conversation with the caller to find out who it is and the purpose of their visit—before you even approach the door.

Doorbell chimes

With ComPoint, you can have separate doorbell chimes for two doors. You have a choice of seven different chime tones that your installer can assign. Or you can use a separate doorbell system if you prefer.

Door strike release

Did someone in the family forget their keys? Did a friend drop by? ComPoint offers an optional module that works with a door strike release to let you admit your visitor from any keypad without going to the door in person. Imagine the convenience of not having to leave the baby or interrupt an important task to go and open the door for your visitor.

Listen to another room

Need to keep an ear open for someone? Wondering what the kids are doing? With ComPoint you're within earshot of any other room. Listen mode keeps you in touch with what's going on in any room with a keypad.

Do not disturb

When you've tucked your kids into bed or you need peace and quiet in the study to concentrate, you can switch the room keypad to Do Not Disturb. This prevents all communication events from being heard in that room.

Hands free

One of the nicest features in ComPoint is the ability to reply to intercom calls without having to touch the keypad. And when the delivery person rings your doorbell, they can answer your reply without having to press the Call key again.

Integration with your music system

For even greater convenience, your ComPoint system can share the speakers in your multiroom audio system. When active, ComPoint switches the speakers over to the keypad amplifiers in the affected rooms, momentarily interrupting the audio program. When the activity ends, the speakers resume playing your audio program.

As an alternative, ComPoint can stand alone by using the optional ISSP ComPoint Speakers next to the keypads.

About this manual

This section of the manual is for you, the user. It explains what you need to know to use and enjoy your ComPoint system.

Reading these first several pages will help you get the most out of your system. As you learn, share your discoveries with others in your family or office so they too can enjoy using ComPoint.

The Installer section that follows provides more technical information and gets into the nitty gritty of how the system works. It's intended for your installer, but you're welcome to read it, too.

We recommend keeping this manual in a safe, accessible place so you can refer to it when you need to.

USER SECTION

System Components

What's in your ComPoint system

ISK1 Basic or ISK2 Advanced Keypad

The keypads control the system and serve as your interior communication points. A simple array of keys lets you easily operate your system. In addition, each keypad contains a built-in microphone and a small amplifier to power one or two speakers.

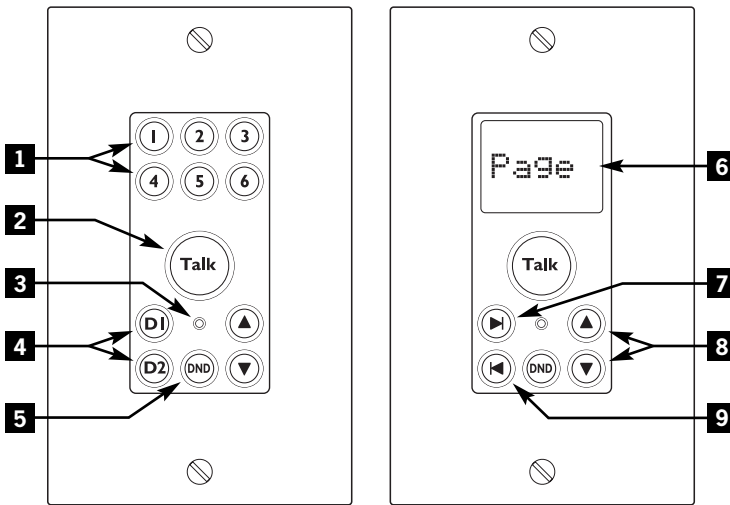

ISK1 Basic and ISK2 Advanced Keypads

- 1** ZONE KEYS – Select and indicate zones (Basic Keypad only)
- 2** TALK KEY – Allows communication from the keypad to other zones
- 3** MICROPHONE – Picks up user's voice for communications and ambient sounds for Listen mode
- 4** DOOR KEYS – Select and indicate door stations; also activate door strike release (Basic Keypad only)
- 5** DO NOT DISTURB KEY – Turns Do Not Disturb mode on and off
- 6** DISPLAY – Shows zone and door station labels; also indicates modes (Advanced Keypad only)
- 7** NEXT KEY – Scrolls forward through lists and installer menus on display (Advanced Keypad only)
- 8** VOLUME KEYS – Control keypad output volume
- 9** PREVIOUS KEY – Scrolls backward through lists and installer menus; also activates door release with Next key (Advanced Keypad only)

ISK3 Door Station

Designed for outdoor placement, the weatherproof door station provides a communication link to visitors. It contains a built-in microphone and a speaker for two-way communication and features a simple yet elegant one-key design.

- 1** MICROPHONE AND SPEAKER – Enable two-way communication
- 2** CALL KEY – Rings doorbell and starts a door call
- 3** WEATHERPROOF COVER – Protects internal components

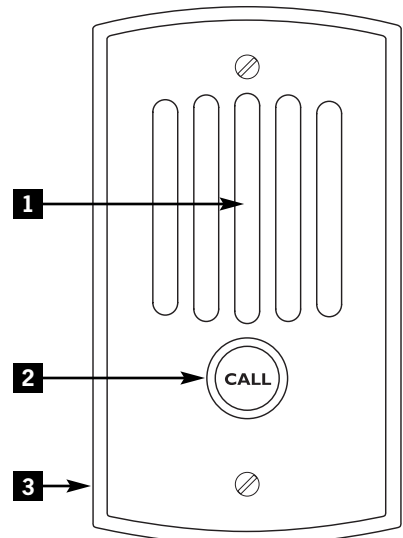

ISK3 Door Station

ISH1 Hub

As the heart of the system, the hub keeps track of the zones and routes communications appropriately. It also provides your choice of chime sounds for the built-in doorbell feature, which plays chimes through the speakers in each room.

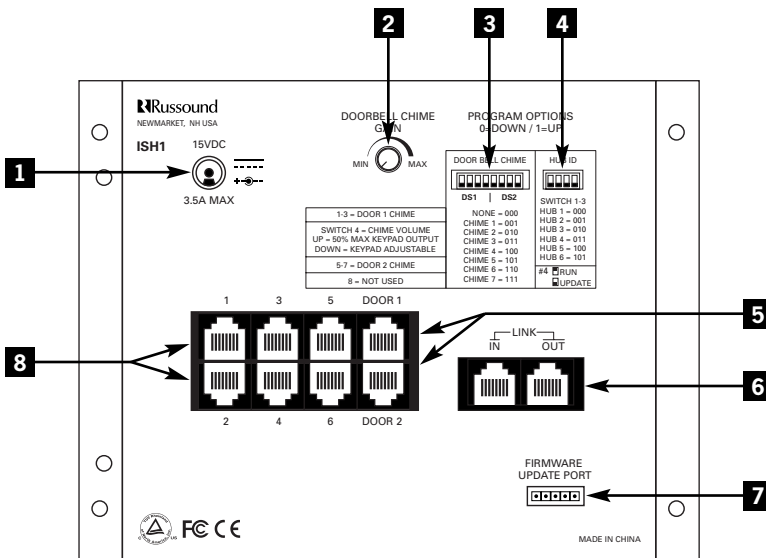

ISH1 Hub

- 1** POWER INPUT – For connecting a Russound ISPS power supply, 15 VDC 3.5 A
- 2** DOORBELL CHIME GAIN CONTROL – For adjusting the overall volume of the doorbell chimes
- 3** DOORBELL CHIME SWITCHES – For selecting individual chime tones for one or two door stations
- 4** HUB ID SWITCHES – For assigning the hub a unique ID number in a multiple-hub system
- 5** DOOR STATION PORTS – For connecting ISK3 Door Stations
- 6** LINK PORTS – For connecting multiple hubs together
- 7** FIRMWARE UPDATE PORT – For updating system firmware from a computer
- 8** ZONE KEYPAD PORTS – For connecting ISK1 Basic or ISK2 Advanced Keypads

USER SECTION

System Components

ISDR1 Door Strike Release Module

This optional module provides a connection point for a separate door strike release unit, making it possible to unlock the door from any keypad.

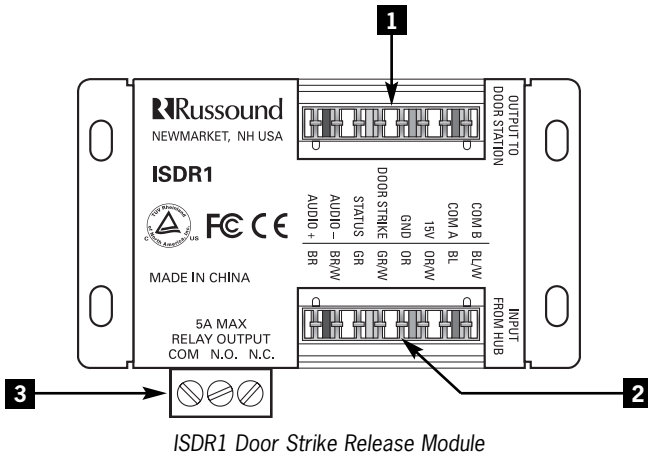

- 1** OUTPUT CONNECTOR – Punch-down connector for CAT-5 cable to an ISK3 Door Station
- 2** INPUT CONNECTOR – Punch-down connector for CAT-5 cable from the ISH1 hub
- 3** RELAY OUTPUT CONNECTOR – Removable connector for a door strike release, gate actuator, or other device

ISSP ComPoint Speaker

This optional in-wall speaker sits beside a Basic or Advanced keypad in a room without multiroom audio system speakers. It can also be used in every room when ComPoint is used as a stand-alone system.

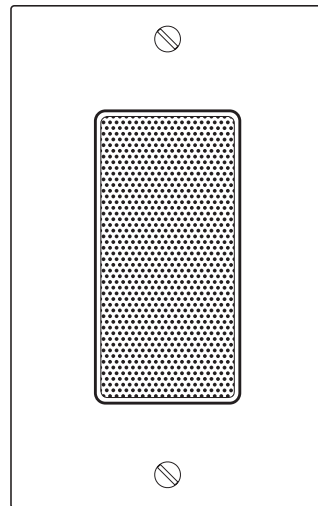

ISSP ComPoint Speaker

Using your ComPoint system

ComPoint is easy and fun to use. You'll find these instructions simple to follow. Take a little time to get familiar with them so you can start enjoying your system right away.

Things you'll need to know

With ComPoint, we refer to areas with keypads as *zones*. A zone may be a single room or an area with more than one room, such as a kitchen and dining area.

Every communication has a sender and a receiver. With ComPoint, we call any zone that starts a communication the *sending zone*. The zone or zones to which the communication is sent are *receiving zones*, even though they may reply to the initial communication. For an intercom session, the receiving zone is also the *target zone*.

Certain communications take priority over others. A door station call interrupts any other communication in progress. Paging is allowed only when there is no door station call or intercom session already under way. An intercom session is allowed only when there is no door station call or page in progress. Paging and intercom interrupt Listen mode.

Your ComPoint system is configured with either ISK1 Basic or ISK2 Advanced keypads. The way you use your system and the way it gives you information depends on which keypads you have.

With either keypad, pressing the Talk key sounds a ping tone in the receiving zones to announce your message. Releasing the Talk key sounds a double ping.

If the system is already in use when you try to send a page or start an intercom session, the Talk key blinks red for 7 seconds to let you know the system is busy. Also, the Advanced Keypad indicates **Busy** on its LCD panel.

Paging

Paging lets you send an announcement throughout your home or business from any keypad.

To send a page, just press and hold the Talk key, then speak. Release the key when you're done.

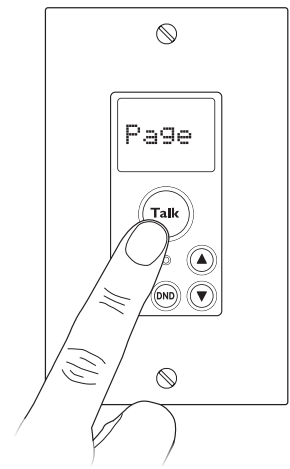

Using the Talk key for paging

Your page will be heard in all zones except those that are in Do Not Disturb mode. For privacy and to avoid disturbing your neighbors, your page will not be heard at either door station.

If a zone key is lit red on the Basic Keypad, press the key to deselect that zone before you press the Talk key to send a page.

USER SECTION

Operation

Paging (cont'd)

If a zone label appears on the Advanced Keypad, use the Next or Previous key to select **Page** before you press the Talk key.

All keypads indicate which zone is sending a page, so you'll know where it's coming from. The zone indication remains for 30 seconds after the Talk key is released to simplify replying to the page.

The keypads in the receiving zones also sound a double ping when the Talk key is released. This lets you know the person sending the page is done speaking and you can reply to the page. Within 30 seconds, simply press and hold the Talk key and speak. Your reply will be heard only in the zone that sent the page.

If you wish to reply to the page after the 30-second limit, you can use the intercom function described below or a return page to send your reply.

Intercom

Unlike a system-wide page, an intercom session occurs only between two zones.

To send an intercom, select a target zone on a keypad. Press and hold the Talk key and speak. Release the Talk key when you're done speaking.

Basic Keypad. Press and release a zone key to select the target zone. The key lights up red to indicate the zone is selected.

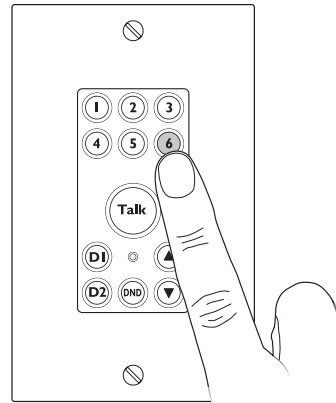

Selecting a target zone on the Basic Keypad

If the selected target zone is in Do Not Disturb mode, the zone key and DND key blink rapidly for 7 seconds.

Advanced Keypad. Select a target zone by using the Previous or Next key to scroll through the list of available zones until the display shows the zone you want for the intercom session.

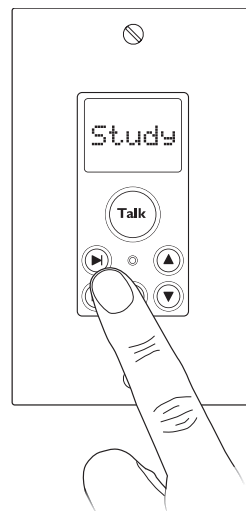

Selecting a target zone on the Advanced Keypad

Intercom (cont'd)

If the selected zone is in Do Not Disturb mode, the display alternately shows the zone label and **DND** at 1-second intervals and the DND key blinks rapidly for 7 seconds.

Receiving an intercom. When the Talk key is pressed on the sending keypad, the receiving keypad indicates which zone is sending the intercom. Also, both the sending and receiving keypads sound a single ping to let you know you can reply hands free within 7 seconds. After the 7 seconds, the keypads sound a double ping to signal the end of the hands-free reply period.

After the double ping, you can reply within 30 seconds by pressing and holding the Talk key while you speak. After 30 seconds you can no longer reply, but you can start another intercom session to the zone that sent the original message.

Door station call

A visitor can ring the doorbell and start a door station call by simply pressing and releasing the Call key.

When the Call key is pressed, all keypads indicate the calling door station for 15 seconds. The D1 or D2 key on the Basic Keypad blinks red and the display on the Advanced Keypad shows **Door1**, **Door2**, or an installer-assigned door label.

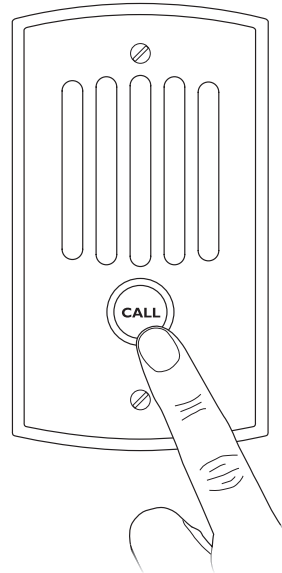

Using the Call key on a Door Station

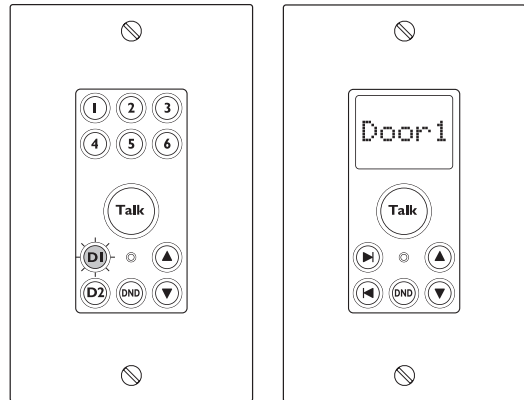

Door call indication on Basic and Advanced keypads

The keypads also sound a doorbell chime, as long as they aren't in Do Not Disturb mode and a chime option is selected on the hub. Additionally, the door station can ring a traditional doorbell system as well.

USER SECTION

Operation

Door station call *(cont'd)*

A door station call takes precedence over paging and intercom sessions and thus interrupts them if they're in progress when the Call key is pressed.

To reply to a door station call, press and hold the Talk key on a keypad within 15 seconds and speak. Release the Talk key when you're done speaking. When you release the Talk key, the door station sounds a single ping to let the caller know they can answer your reply.

Note: You must use the Talk key to reply to a door station call. For your privacy, ComPoint doesn't allow a hands-free reply to a door station call.

After you reply to a door station call, the caller has 7 seconds to answer your reply hands free. After 7 seconds, the door station pings twice to indicate the time is up.

If more than 15 seconds have passed since the door call, you can reselect the door station and press the Talk key to start a new session. This does not ring the doorbell.

Door strike release

If your ComPoint system includes optional ISDR1 Door Strike Release Modules, you can activate them from a keypad to unlock the doors. The ISDR1 itself does not unlock the door; rather, it provides a switch to control a separate door strike release unit to unlock the door.

Basic Keypad. Press and hold the corresponding door station key for 3 seconds.

The module then activates for 3 seconds and the keypad and door station confirm activation with a buzz tone.

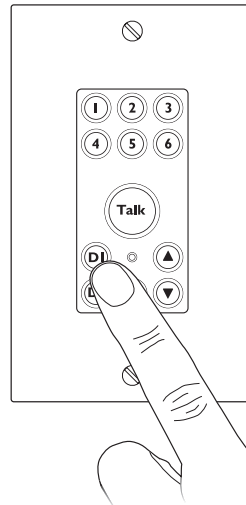

Releasing a door strike on the Basic Keypad

Door strike release (cont'd)

Advanced Keypad. During a door call, press and hold both the Previous and Next keys at the same time for 3 seconds.

When there is no current door call session, first press the Previous or Next key to scroll through the list to the door label. Then press and hold both keys for 3 seconds.

The module then activates for 3 seconds and the keypad and door station sound a buzz tone to confirm activation.

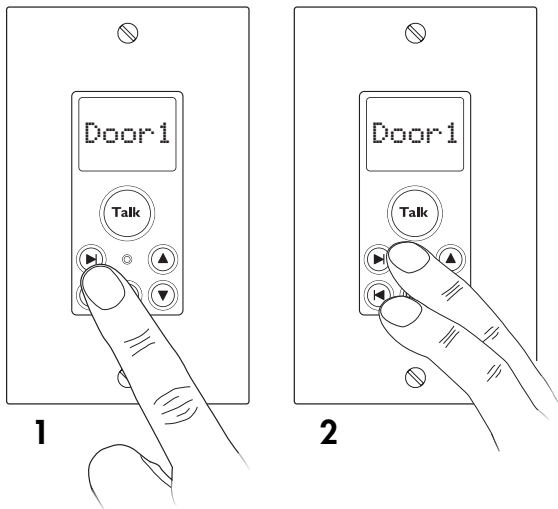

Releasing a door strike on the Advanced Keypad

Listen mode

You can use your ComPoint system to continuously listen to any single zone from one or more other zones. To do this, first turn on a keypad microphone in the zone you want to listen to, then select that zone on one or more other keypads.

Other communication events have priority over Listen mode but only temporarily interrupt it.

To turn on a zone microphone, select that zone on its own keypad. The Talk key lights up red to indicate the keypad's microphone is active. On a Basic keypad, the zone key blinks and on an Advanced Keypad, the zone label changes to **MicOn** after 2 seconds. **Note:** Only one zone microphone can be on at once.

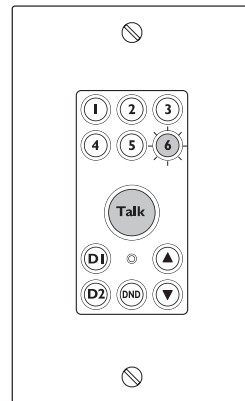

Basic Keypad Microphone On indication

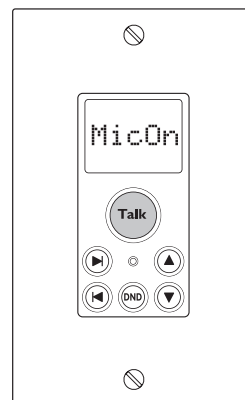

Advanced Keypad Microphone On indication

USER SECTION

Operation

Listen mode (cont'd)

Basic Keypad. To listen to the zone with the active microphone, press the zone key. The key blinks three times and then remains lit red to indicate selection of the zone with the active microphone.

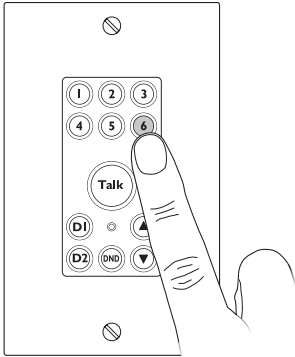

Selecting Listen mode on the Basic Keypad

Advanced Keypad. To listen to the zone with the active microphone, press the Previous or Next key to select the zone. The display will alternately toggle between the zone label and **Listn** as long as the active zone is selected.

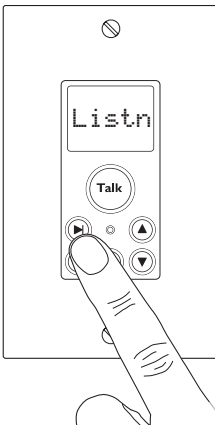

Selecting Listen mode on the Advanced Keypad

To cancel Listen mode with either type of keypad, deselect the zone you are listening to on the keypad in that zone. Listen mode cannot be canceled from any other zone.

Do Not Disturb mode

The Do Not Disturb (DND) feature allows you to prevent pages, intercom sessions, door station calls, and doorbell chimes from being heard in a zone. Thus, you can use DND mode to prevent interruption of a multiroom audio program in that zone.

To turn on DND mode, press and release the DND key. The DND key lights up red to indicate the zone is in DND mode.

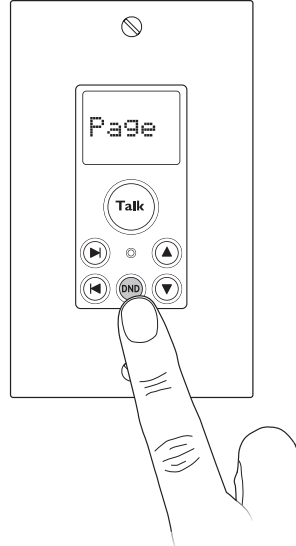

Selecting Do Not Disturb mode

To cancel DND mode, press any key on the keypad other than Volume Up or Volume Down.

Combined Listen and DND modes

You can use DND mode on a keypad you are listening to in Listen mode. This way the zone you're listening to won't be disturbed by the doorbell or other communication events.

To set up a zone for Listen mode and DND, first activate the keypad's microphone by selecting that zone on the keypad. Then turn on DND.

The Talk key and DND key light up red to indicate the keypad's microphone is on and the zone is also in DND mode. On a Basic Keypad, the zone key also blinks. On an Advanced Keypad, the display also shows **MicOn**.

Another Advanced Keypad listening to that zone alternately displays the zone label, **Listn**, and **DND**.

Enjoy!

With ComPoint, we've created a versatile communication system that fits in with any lifestyle. We're sure you'll find ComPoint very practical and a pleasure to use.

INSTALLER SECTION

Product Summary

About this section

This section of the manual provides technical information for installing and programming the ComPoint system. It also provides detailed descriptions of the system functions.

Product summary

The ComPoint system uses one or more central hubs, each of which supports up to 6 keypads. Each keypad is addressable by its own unique ID number assigned by the hub.

ComPoint connects with CAT-5 cable, which conveys power, ground, audio, and data

between the components. The cable length limit for any zone or door station is 250 feet (76 m).

The system can include one or two door stations connected to hub #1. Each door station has its own unique ID number, permanently assigned in the system firmware.

Each door station may also have a door strike release module wired in line between the hub and the station.

Simple system programming is required to assign the hub ID numbers, doorbell chimes, and when ISK2 Advanced Keypads are used, zone and door labels.

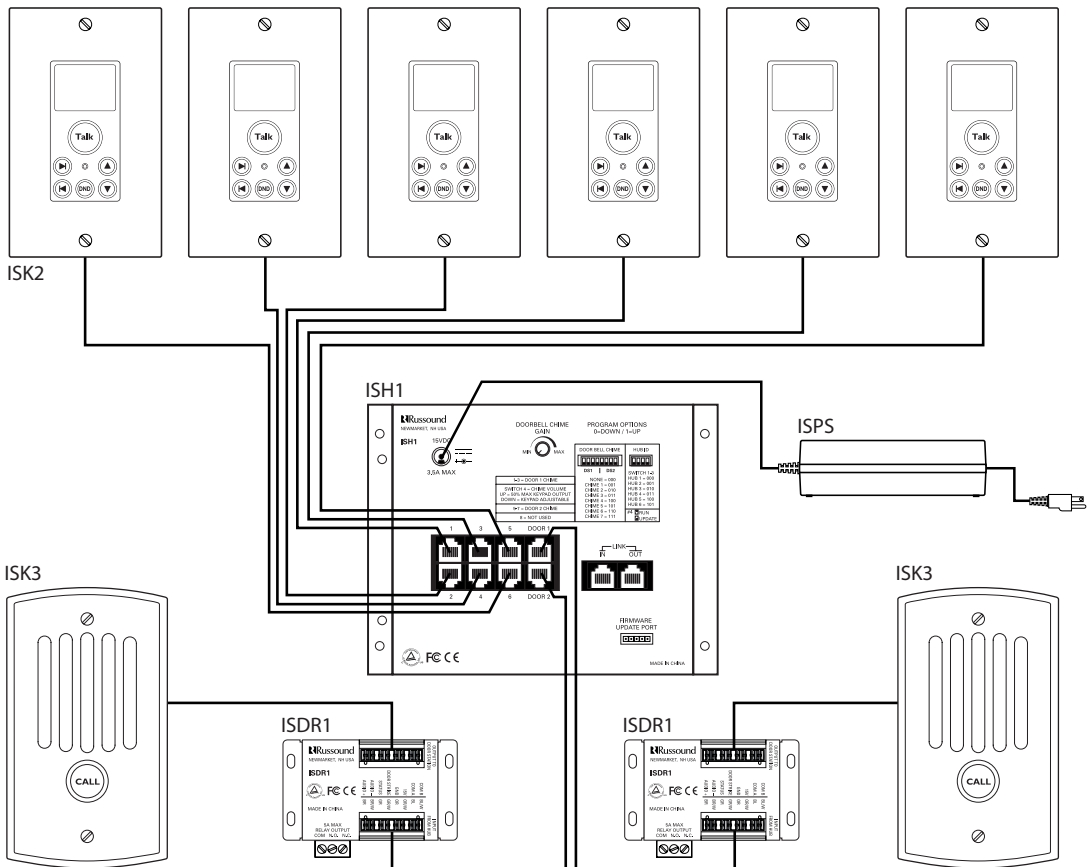

Six-zone ComPoint system with Advanced Keypads and Door Strike Release Modules

ISH1 Hub

As the central controller for the ComPoint system, the ISH1 hub performs all communications routing. It addresses each keypad by sending a message on the status wire in the CAT-5 cable to give the keypad its own ID number according to the port it's connected to.

The hub has 6 zone keypad ports. Up to 6 ISH1 hubs can be linked together for a maximum of 36 zones. With multiple hubs, each hub must be assigned a unique ID number during installation.

The hub also has ports for 2 door stations. In a system with multiple linked hubs, only the hub with ID number 1 supports the door stations.

A separate doorbell chime tone can be selected on hub 1 for each door. These chime selections take effect for the entire system and play through all the zone keypads.

The hub's firmware contains a list of zone labels for display on the ISK2 Advanced Keypads. The labels are assigned to zones by the installer and stored in nonvolatile memory within the hub.

The ISH1 hub uses an external power supply to conserve chassis space. It also has a port for updating the system firmware from a computer.

System keypads

ComPoint keypads are designed to be simple, intuitive interfaces for the user. Each model has a Talk key, volume keys, and a DND key for setting the zone in Do Not Disturb mode. Both models have installer-selectable amber or green backlighting that turns on when the system is used and turns off after the system is inactive for 60 seconds. A built-in microphone with automatic gain control picks up the user's voice.

The keypads require external speakers, which are driven by the keypad amplifiers for communications. By using built-in speaker relays, the keypads can share the speakers used in a multiroom audio system. When ComPoint activates,

the relays switch the speakers from the audio system to the keypad amplifiers in the affected zones, momentarily interrupting the audio program. When the activity ceases, the speakers are switched back to the audio system.

In the absence of a multiroom audio system, or in zones that are not shared with an audio system, the ISSP ComPoint speaker can be used or the keypads can be wired directly to in-wall, in-ceiling, or surface-mounted speakers.

The keypad amplifier is monaural, but the relay passes stereo signals from the audio system to the speakers.

The keypad volume keys adjust the listening level for communications by controlling the keypad's amplifier output. They have no effect on the room volume for a connected audio system.

The volume keys signal the hub to send a ping tone as an audible cue for the volume level when there is no communication taking place. Once the volume adjustment reaches either end of the range, the ping tone no longer sounds.

ISK1 Basic Keypad

The ISK1 Basic Keypad is designed for use in a system with no more than six zones. Pressing a zone key selects a target zone for an intercom session.

Certain keys change to red to indicate zone or door station selection, incoming page or intercom, door station call, or system busy. When another zone originates a page or intercom session, that zone is indicated by a red-backlit zone key on the ISK1.

ISK2 Advanced Keypad

The ISK2 Advanced Keypad has enhanced features to provide more user feedback and support a larger system than the ISK1. It uses a 5-character LCD panel to show zone and door station labels and other information.

INSTALLER SECTION

Product Summary/Installation

ISK2 Advanced Keypad (cont'd)

One of the benefits of the Advanced Keypad is the ability to support systems as large as 36 zones, since the ISK2 is able to select any of the zones by label. The zone and door station labels are dynamically served from the hub and appear in alphabetical order on the keypad display. A Page label is included in the list as the default selection when the system is inactive and the Talk key is pressed.

On the ISK2, the target zone for an intercom session is selected by scrolling through the zone list. Pressing and holding the Previous or Next key scrolls through the list with a half-second delay between zone labels.

A bar graph on the display indicates the zone volume level visually in conjunction with the audible ping tones. A small pushbutton on the front edge of the keypad is used to enter a setup mode to assign labels to the zones.

ISK3 Door Station

Unlike the Basic and Advanced Keypads, the ISK3 Door Station has only one key and contains an internal speaker. Amplification for the speaker is built in as with the keypads but there is no speaker interrupt relay. A potentiometer allows adjustment of the speaker volume level.

The ISK3 also provides contacts for closing a standard doorbell circuit. These close for a minimum of 4 seconds to activate an existing doorbell or other device.

ISDR1 Door Strike Release Module

The optional ISDR1 Door Strike Release Module provides relay contacts for activating a door strike release from another manufacturer. The module connects in the CAT-5 line between a hub and an ISK3 door station. The ISDR1 can be located anywhere in the CAT-5 line, though it would be preferable to have it close to the door.

The ISDR1 obtains its operational power from the hub. The separate door strike release must receive voltage from its own power source.

The ISDR1 passes signals on all leads of the CAT-5 cable except one which is used to activate the module from the hub upon receiving a command from a keypad.

By providing a normally closed (NC) relay contact in addition to the normally open (NO) and common contacts used for the door strike release activation, the ISDR1 can be used for other applications where a versatile relay is needed. The ISDR1 can be activated by providing 15 VDC between two of the eight positions in the 110 punch-down input connector.

Keypad backlight color selection

Each ComPoint keypad can be set to either amber or green backlighting, selected by a miniature slide switch on the bottom edge of one of the circuit boards.

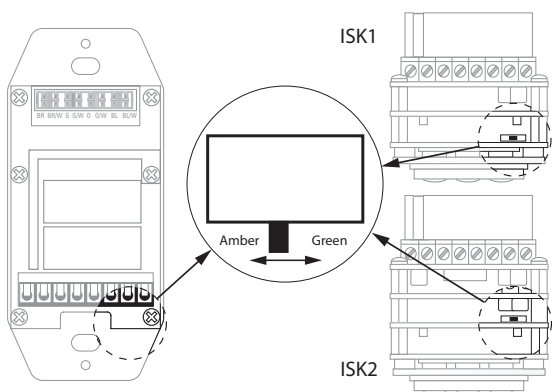

Keypad backlight color selector switch

Select the desired backlight color before installing the keypads.

Device installation and trim

The ISH1 hub is designed for surface mounting or installation in a structured wiring panel. It should be located near an electrical outlet.

The ISK1 and ISK2 Keypads are designed to install in standard US electrical plastic wall boxes with an internal volume of at least 18 cubic inches (295 cm³). Each keypad occupies a single gang and accepts a Decora® wall plate.

For the best accessibility, viewability, and microphone reception, we recommend installing the keypads at a standard thermostat height of 58 to 60 inches (1.5 m). This may vary according to personal preferences or requirements.

The ISK3 Door Station installs in a standard single-gang US electrical deep plastic wall box with an internal volume of at least 22 cubic inches (360 cm³). It has its own weather-resistant front plate and thus needs no other cover plate.

The ISDR1 Door Strike Release Module is a surface-mount device. It should be located in an accessible area near the door, such as an attic, basement, or closet space between the door station and the hub. The ISDR1 connects to a door strike release unit, which in most cases would be installed by a security contractor.

Wiring and connections

ComPoint system components connect with CAT-5 cable. Run CAT-5 from the hub location to every keypad and door station location. If you are installing ISDR1 modules, loop the door station cables through the module locations.

Each keypad in the system requires one or two external speakers. If the ComPoint system is sharing speakers with an audio system, loop the speaker cables through the keypad locations. If dedicated speakers are being used, run the speaker cables to the keypads.

When running CAT-5 and speaker cables, avoid running them near AC power wiring. If you must run the cables parallel to electrical wiring, space the cables at least 12 inches (30 cm) from the AC power lines.

110 punch-down connections

The keypads, door stations, and door strike release modules have 110 punch-down connectors for the CAT-5 cables. Connect the wires with a punch-down tool as shown below.

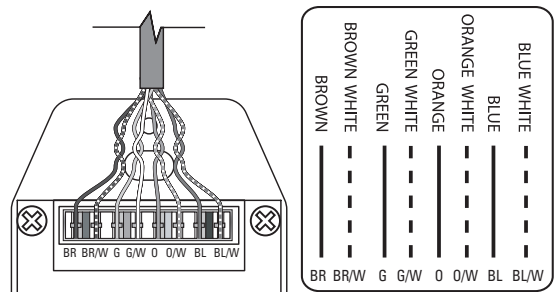

110 punch-down connection

The keypad wire functions are as follows:

Wire Color	Function
Brown	Audio +
Brown/White	Audio -
Green	Status
Green/White	Ground
Orange	Ground
Orange/White	+ 15 VDC
Blue	Com A
Blue/White	Com B

INSTALLER SECTION

Installation

Speaker connections

Each keypad has an 8-pole screw-terminal connector for accessing the internal speaker relay. This connector is typically used for connecting the zone speakers in a multiroom audio system. In a zone where the ComPoint system does not share speakers with an audio system, connect a dedicated speaker or pair of speakers to the output terminals.

Note: Both speaker output channels must be connected, since they are wired in series. If you are using a single dedicated 8-ohm speaker such as the ISSP ComPoint Speaker, connect the speaker to one channel and a shorting jumper to the other channel. If you are using a single 4-ohm speaker, connect it to one channel and a 4-ohm, 2-watt power resistor to the other channel.

Be sure to observe polarity when connecting the speaker wires. The standard color code for 4-conductor speaker cable is as follows:

Wire Color	Polarity
White	Left +
Green	Left -
Black	Right -
Red	Right +

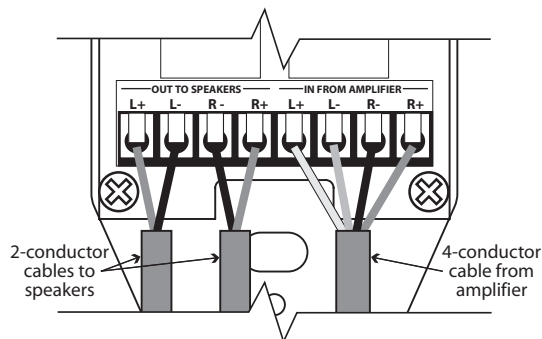

Multiroom speaker connection to keypad

Hub modular connections

The hub has 8-pole modular jacks for keypad and door station connections. The keypads connect to ports 1 through 6, and the door stations connect to DOOR1 and DOOR2. These connections must be made according to the T568A standard as shown below.

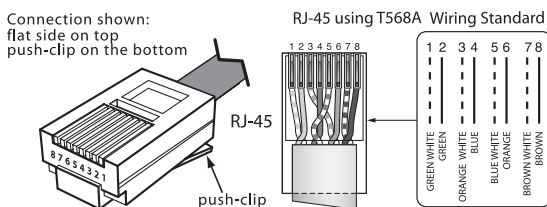

8-pole modular T568A connection

The hub also uses modular jacks for the link ports. You may use any 8-pole straight-through RJ-45 patch cable to link hubs together.

Doorbell connections

ComPoint can operate a separate doorbell system as well as provide doorbell chime tones in the zones. To use a separate doorbell, connect each door station to the doorbell as shown below or in the doorbell system instructions.

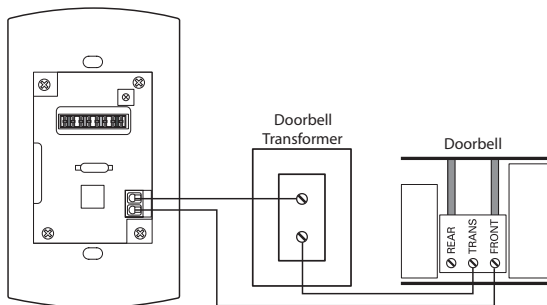

Doorbell connection to rear of ISK3 Door Station

Door strike release connections

The door strike release module has 110 punch-down connectors for the hub and door station cables. It also has screw terminals for its relay contacts that accept up to 14 AWG stranded wire. The figure below shows the connections.

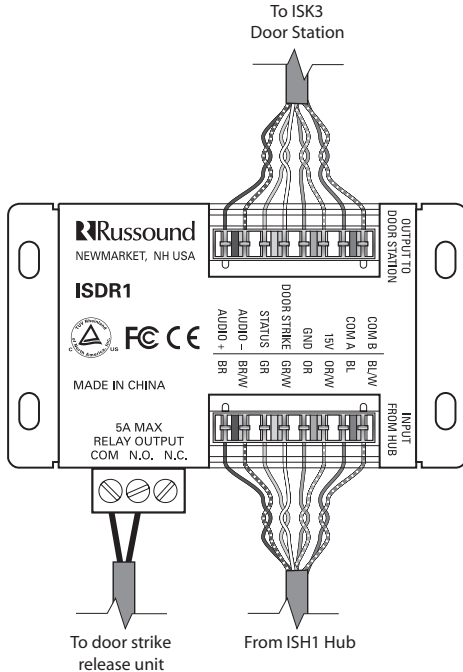

Door Strike Release Module connections

Power connection

After making all other connections and setting the hub ID numbers (see next section), plug an ISPS power supply into the power input jack on each ISH1 hub.

Upon powering up, the hub(s) register all the connected keypads and door stations for proper communications routing. Wait 15 seconds for registration to complete before operating the system. If a keypad or door station is connected or hubs are linked while the system is powered up, you will need to cycle power to the hub(s).

System programming

Overview

All system programming resides in the ISH1 hub. For a six-zone system with ISK1 Basic Keypads, programming consists only of setting the doorbell chimes. For a system with ISK2 Advanced Keypads, programming includes assigning zone and door station labels. For a system with more than six zones, programming includes setting hub ID numbers.

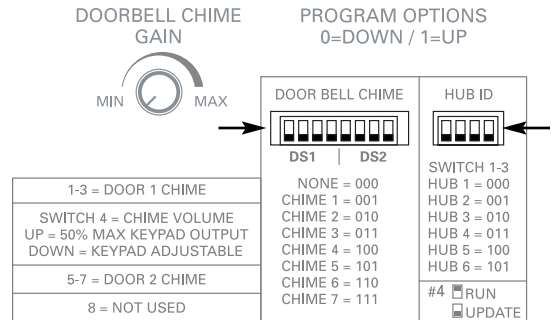

DIP switches on ISH1 hub

The ISH1 hub has DIP switches for setting the doorbell chime and hub ID number assignments. The hub's firmware includes zone and door station labels for display on the ISK2 Advanced Keypads. These labels are assigned by using a connected ISK2 keypad.

With multiple hubs, the label settings are initially stored in the hub to which the keypad is connected. Upon exiting the programming procedure, the settings are copied to the other hubs.

Hub 1 serves as the master hub for storing all zone and door label settings. Whenever hub 1 is powered up, its settings are copied to the other hubs. Accordingly, hub 1 should be powered up last whenever the system power is cycled.

INSTALLER SECTION

Programming

Doorbell chimes

A single 8-switch DIP assigns doorbell chimes for both door stations. Switches 1 through 3 select the chime for door 1 and switches 5 through 7 select the chime for door 2. There are 7 chime options as well as a setting for no chime when a separate doorbell system is used. To select the chimes, set the switches as shown in the table below.

Doorbell Chime Switch Settings (0 = Down, 1 = Up)								
Switches	Door 1			CV*	Door 2			8
	1	2	3	4	5	6	7	
None	0	0	0	0/1	0	0	0	–
Chime 1	0	0	1	0/1	0	0	1	–
Chime 2	0	1	0	0/1	0	1	0	–
Chime 3	0	1	1	0/1	0	1	1	–
Chime 4	1	0	0	0/1	1	0	0	–
Chime 5	1	0	1	0/1	1	0	1	–
Chime 6	1	1	0	0/1	1	1	0	–
Chime 7	1	1	1	0/1	1	1	1	–

*Switch 4 is for chime volume
(0 = Keypad Adjustable, 1 = 50% Keypad Maximum)

Doorbell chime switch settings

Switch 4 selects how the chime volume level is managed. Setting the switch to 1 (up) sets the chime volume level to a fixed level at 50% of the maximum keypad output in all zones. This causes the chime to play at the same level in all zones. Setting the switch to 0 (down) allows the chime volume to be determined by the keypad volume level setting in each zone independently.

Switch 8 is currently not used.

The ISH1 hub also has a gain control for setting the overall volume of the doorbell chime through the system. This can be used to adjust the chime level relative to the communication level.

Note: In a system with multiple linked hubs, only the settings on hub 1 affect the doorbell chime assignments and volume level, since the door stations connect only to hub 1. Because the settings take effect immediately, the doorbell chimes can be set at any time. There is no need to cycle the power after setting them.

Hub ID numbers

In any ComPoint system, there must be a hub with ID number 1. In a multiple-hub system, each hub's ID number must be unique. On each hub the ID number is manually assigned on the 4-switch HUB ID DIP before the system is powered up. To assign the ID number, set switches 1 through 3 as shown in the table below.

Hub ID Switch Settings (0 = Down, 1 = Up)				
Switches	Hub ID			FW*
	1	2	3	4
Hub 1	0	0	0	1
Hub 2	0	0	1	1
Hub 3	0	1	0	1
Hub 4	0	1	1	1
Hub 5	1	0	0	1
Hub 6	1	0	1	1

*Switch 4 is for firmware updates
(0 = Update Mode, 1 = User Mode)

Hub ID switch settings

Switch 4 enables a programming mode for updating the system firmware. Leave this switch in the up position for system operation.

To obtain the firmware and update instruction files, download them from the Document Center at www.russound.com.

Zone Label	Room Name	Zone Label	Room Name	Zone Label	Room Name
Alcov	Alcove	Dine	Dining Room	Loft	Loft
Atrm	Atrium	Entry	Entry Way	MBath	Master Bath
Attic	Attic	Family	Family Room	MBed	Master Bed
Baby	Baby Room	Foyer	Foyer	Nurse	Nursery
Bar	Bar	FtYrd	Front Yard	Offc1	Office 1
Basmt	Basement	Galry	Gallery	Offc2	Office 2
Bath	Bathroom	Game	Game Room	Parlr	Parlor
Bath2	Bathroom 2	Gardn	Garden	Patio	Patio
Bath3	Bathroom 3	GBath	Guest Bath	Play	Play Room
BDeck	Back Deck	GBed	Guest Bed	Pntry	Pantry
Bed1	Bedroom 1	Grage	Garage	Pool	Pool
Bed2	Bedroom 2	Great	Great Room	Porch	Porch
Bed3	Bedroom 3	Guest	Guest Room	RecRm	Rec Room
Bed4	Bedroom 4	Gym	Gym	Sauna	Sauna
Bed5	Bedroom 5	Jcuzi	Jacuzzi	SDeck	Side Deck
Bilrd	Billiard Room	KBed	Kids Bed	Shop	Shop
BkYrd	Back Yard	Kids	Kids Room	SitRm	Sitting Room
Blcny	Balcony	Kitch	Kitchen	State	State Room
Cellr	Cellar	Laund	Laundry	Study	Study
Court	Courtyard	Libry	Library	SunRm	Sun Room
Deck	Deck	LivRm	Living Room	Wkshp	Workshop
Den	Den	Lobby	Lobby		

Assignable zone labels for ISK2 Advanced Keypads

Zone and door station labels for Advanced Keypads

The ISK2 Advanced Keypad shows which zone or door station is selected by displaying a zone or door station label. The default zone labels are Zn#1 through Zn#36, based on the hub and port numbers the keypads are connected to. The default door station labels are Door1 and Door2. You can assign zone labels from the table above and door station labels from the table to the right to replace the default labels. The hubs retain label assignments in nonvolatile memory so they won't be affected if the system loses power.

Keypad connected to any hub. You can use the same keypad to assign labels for the entire system. The system must be powered up to assign labels.

Door Label	Door Name
BDoor	Back Door
FDoor	Front Door
Gate	Gate
Grage	Garage
SDoor	Side Door
SvcDr	Service Door

Assignable door labels for ISK2

To assign labels you must have all hubs linked together with unique ID numbers (if the system has multiple hubs) and an ISK2 Advanced

INSTALLER SECTION

Programming

Assigning zone labels

To assign zone labels, follow these steps (or the ISK2 Keypad Zone Name Procedure flow chart on page 26):

1. Remove the wall plate if it's installed. Press and release the Setup button on the right edge of the keypad to enter the main menu. The display shows **ZName (ZONE NAME)**.

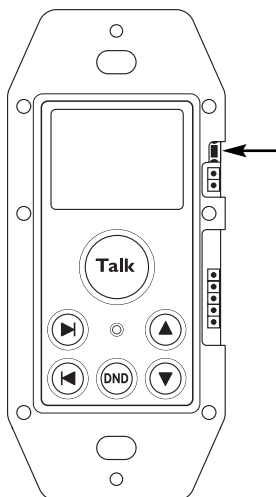

ISK2 Setup Button

2. Press the Talk key to enter the Zone Name procedure. The display shows **Zn#?** to prompt you to select a zone number.
3. Press the Talk key again for the next sequential zone to be assigned or use the Volume Up or Volume Down key to select a specific zone. You can press and hold the key to scroll through the list of zones with a half-second delay between items. Stop at the desired zone number.
4. Press and release the Talk key. The display shows **Name?** to prompt you to assign a zone label.
5. Use the Volume Up or Volume Down key to select a label from the list of zone labels. You can press and hold the key to scroll through the list of zone labels with a half-second delay between items. Stop at the desired label.

6. Press and release the Talk key to save the selection. The display shows **Zn#?** to prompt you to select the next zone.
7. Repeat steps 3 through 6 for the remaining zones.

Press and release the Setup button to exit the procedure. You can then go to the Door Name Procedure by pressing the Next key or press the Setup button again to exit the main menu.

Note: If you aren't sure which zone an ISK2 keypad is connected to, observe the keypad's display when powering up the system. When a hub is powered up, each keypad connected to that hub briefly indicates Page, then the port and hub number to which it is connected. For example, an indication of P4:H2 shows the keypad is connected to port 4 on hub 2. This indication remains for 3 seconds, then reverts to **Page**.

Zones are numbered sequentially starting with hub 1, port 1. The table below shows zone numbers and port assignments.

Zone	Port	Zone	Port	Zone	Port
1	P1:H1	13	P1:H3	25	P1:H5
2	P2:H1	14	P2:H3	26	P2:H5
3	P3:H1	15	P3:H3	27	P3:H5
4	P4:H1	16	P4:H3	28	P4:H5
5	P5:H1	17	P5:H3	29	P5:H5
6	P6:H1	18	P6:H3	30	P6:H5
7	P1:H2	19	P1:H4	31	P1:H6
8	P2:H2	20	P2:H4	32	P2:H6
9	P3:H2	21	P3:H4	33	P3:H6
10	P4:H2	22	P4:H4	34	P4:H6
11	P5:H2	23	P5:H4	35	P5:H6
12	P6:H2	24	P6:H4	36	P6:H6

Zone port assignments

Assigning door station labels

To assign labels to the door stations, follow these steps (or the ISK2 Keypad Door Name Procedure flow chart on page 26):

1. Press and release the Setup button on the right edge of the keypad to enter the main menu. The display shows **ZName (ZONE NAME)**.
2. Press and release the Next key once. The display shows **DName (DOOR NAME)**.
3. Press the Talk key to enter the Door Name procedure. The display shows **Dr#?** to prompt you to select a door station number.
4. Press the Volume Up or Volume Down key to select a door station.
5. Press and release the Talk key. The display shows **Name?** to prompt you for a door station label.
6. Use the Volume Up or Volume Down key to select a label from the list of door station labels. You can press and hold the key to scroll through the list of zone labels with a half-second delay between items. Stop at the desired label.
7. Press and release the Talk key to save the selection. The display shows **Dr#?** to prompt you to select the other door station.
8. To assign a label to the other door station, repeat steps 4 through 7.

Press and release the Setup button once to exit the procedure or twice to exit the main menu.

Once you have assigned the hub ID numbers (for systems with multiple hubs), doorbell chimes, zone labels, and door station labels, the system is fully programmed.

Viewing system information

The System Info Menu allows you to check the build time, build date, and version of the hub's firmware. This is useful to see whether the hub has the latest firmware version. To view system information, follow these steps (or the System Info Menu flow chart on page 27):

1. Press and release the Setup button on the right edge of the keypad to enter the main menu. The display shows **ZName (ZONE NAME)**.

2. Press and release the Next or Previous key twice. The display shows **SInfo (SYSTEM INFO)**.
3. Press the Talk key to enter the System Info menu. The display shows **BTime (BUILD TIME)**.
4. Press and release the Talk key to view the build time, or
5. Press the Next key to go to **BDate (BUILD DATE)**.
6. Press and release the Talk key to view the build date, or
7. Press the Next key to go to **Ver (VERSION)**.
8. Press and release the Talk key to view the version.

Press and release the Setup button once to exit the procedure or twice to exit the main menu.

Restoring factory settings

The Factory Initialization Procedure resets the zone and door station label assignments and zone volume settings to the original factory defaults. This procedure affects the hub to which the keypad is connected, and initializing hub 1 also resets the entire system.

To restore the factory settings, follow these steps (or the Factory Initialization Procedure flow chart on page 27):

1. Press and release the Setup button on the right edge of the keypad to enter the main menu. The display shows **ZName (ZONE NAME)**.
2. Press and release the Next key three times or the Previous key once. The display shows **FInit (FACTORY INIT)**.
3. Press the Talk key to enter the Factory Initialization Procedure. The display shows **Sure? (ARE YOU SURE?)**.
4. Press the Volume Up or Volume Down key to select **Yes**.
5. Press the Talk key to initialize the system. The display shows **Please Wait**, followed by **Cycle Power**.
6. Cycle the power on the hub to which the keypad is connected.

ISK2 Keypad Zone Name Procedure

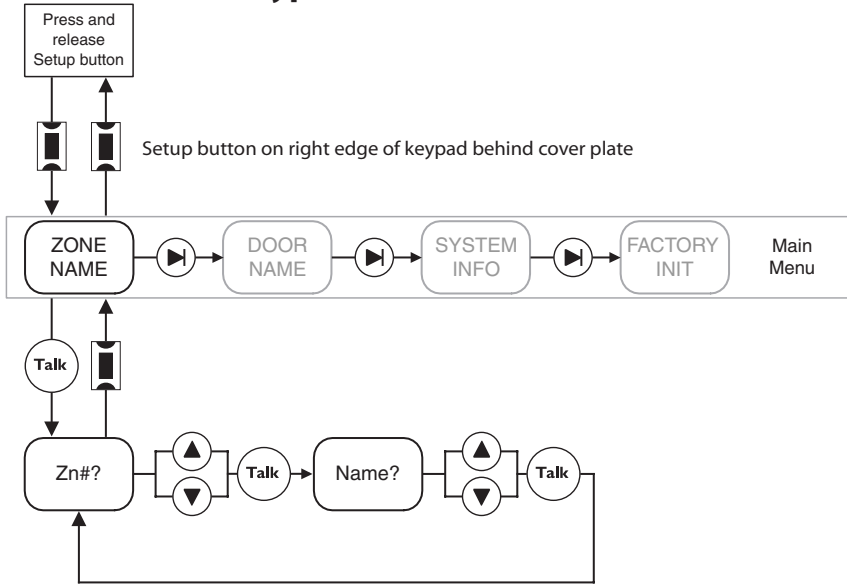

ISK2 Keypad Door Name Procedure

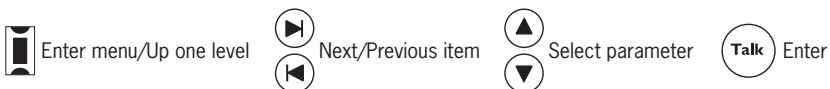
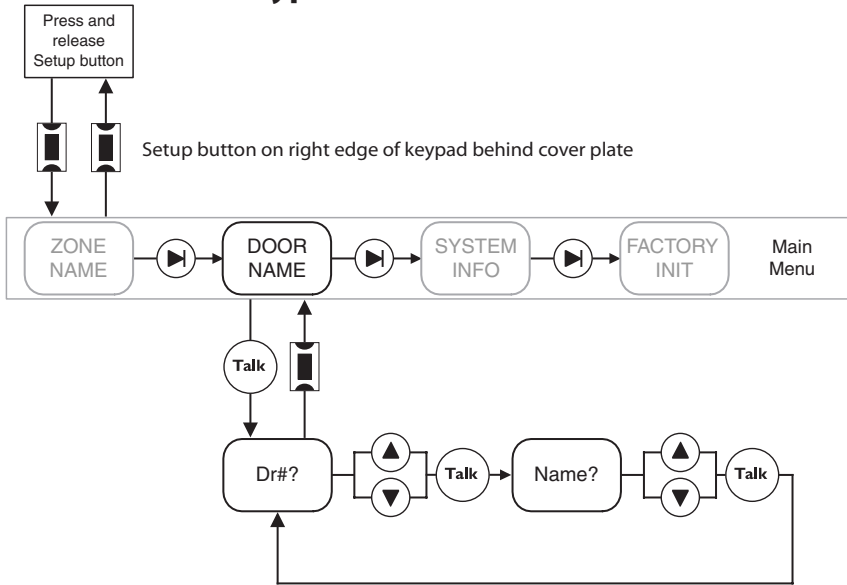

System Info Menu
 Using ISK2 Keypad

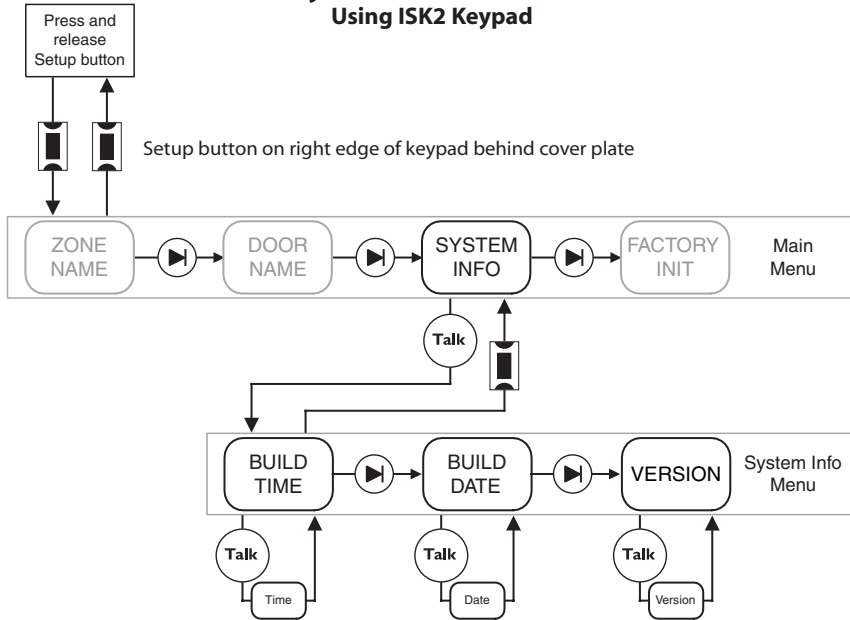

Factory Initialization Procedure
 Using ISK2 Keypad

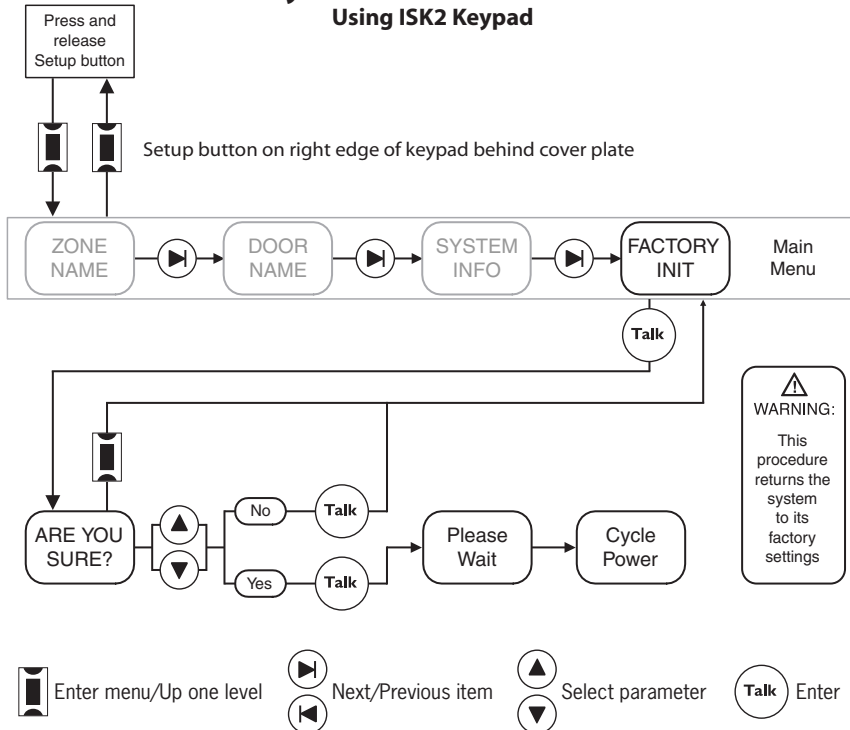

INSTALLER SECTION

System Functions

Detailed function descriptions

ComPoint routes communications by switching its audio bus to the keypads and door stations. All switching takes place in the hub(s). The hub switches the bus to either the microphone or the amplifier in a keypad or door station, depending on the direction of the communication.

For example, when you start an intercom session, the system switches the bus to the microphone in the sending keypad and the keypad amplifier in the selected receiving zone. For the reply, it reverses the connection so the microphone in the receiving keypad is connected to the amplifier in the sending keypad.

Communication priority levels

Certain communication events take priority over others for proper system operation. Each function has a priority level based on its application. If two identical levels of communication overlap, the first to occur has priority.

System functions have the following priorities:

Door station call	Top priority (supersedes all other events)
Paging	Intermediate priority
Intercom	
Listen mode	Low priority

Thus, paging is not allowed when the audio bus is being used for an intercom session or a door station call. Similarly, an intercom session is not allowed when a door call or page is in progress. However, paging and intercom can interrupt Listen mode, and door station calls can interrupt all other communications. DND mode blocks all levels of communication to a zone in that mode.

Paging

Paging is the default system function. To send a page, all one needs to do is press and hold the Talk key and speak, as long as the keypad is not indicating a selected zone or door station. Since a page is a system-wide broadcast, no zone selection is necessary.

When a page is sent, the audio bus connects to the microphone in the sending zone and the amplifiers in all other zones that are not in DND mode. All keypads indicate which zone is sending the page for 30 seconds after the Talk key in the sending zone is released.

During this 30-second time frame, anyone in a receiving zone can reply to the page by holding in the Talk key and speaking. This switches the audio bus to the microphone in the receiving zone and the amplifier in the sending zone. The reply is heard only in the sending zone.

With paging, pressing the Talk key causes a single ping tone to sound in the receiving zones to signal the beginning of the announcement. Releasing the Talk key sounds a double ping to signal the end of the announcement.

Zones in DND mode don't receive a page audio signal but do indicate the sending zone. Also, pages are never sent to door stations.

Intercom

Intercom is a point-to-point communication that involves only two zones, unlike a page which is system wide. For ease of use, the intercom function allows hands-free replies as well as manual replies with the Talk key.

Intercom (cont'd)

The intercom function requires first selecting a target zone. This is done by pressing a zone key on the ISK1 Basic Keypad or scrolling to a zone label on the ISK2 Advanced Keypad. After selecting a zone, the user may press the Talk key to begin communication.

If an invalid zone (one that has no keypad) is selected on an ISK1 Basic Keypad, the zone key blinks rapidly for 7 seconds. Pressing another zone key selects another zone. After a valid target zone is selected, pressing the same zone key deselects it.

If a zone in DND mode is selected on an ISK1 Basic Keypad, the zone key and DND key blink rapidly for 7 seconds when the Talk key is pressed.

With the ISK2 Advanced Keypad, only valid zones (ones with keypads connected) appear in the zone list on the display. If a zone in DND mode is selected, the display alternately shows the zone label and **DND** at 1-second intervals and the DND key blinks rapidly for 7 seconds. A selected zone can be deselected by selecting **Page** or another zone.

When receiving an intercom message, the target keypad indicates the sending zone. This indication remains for a 37-second reply period after the Talk key on the sending keypad is released.

There are two ways to reply to an intercom message with either type of keypad: a hands-free reply within 7 seconds and using the Talk key within 30 seconds thereafter. When the Talk key on the sending keypad is released, both the sending and target keypads sound a single ping

and the target keypad permits a hands-free reply by activating its microphone for 7 seconds. During this period the Talk key on the target keypad is lit red to indicate the microphone is active.

After the 7 seconds, a double ping in both the sending and target zones indicates the end of the hands-free reply period. A reply may still be made by pressing and holding the Talk key within the next 30 seconds. After the 30 seconds, a reply can no longer be made, but a person in the receiving zone can start a new intercom session to the original sender.

Each time a Talk key in either zone is released, a single ping is heard in the other zone and the 7- and 30-second reply periods are renewed.

Door station call

Communication with the door stations is similar to an intercom session, though there are significant differences. First, a door station has no ability to select a target zone. Instead, it simply rings the doorbell and a person in any zone can reply. Second, for privacy reasons the system doesn't allow a hands-free reply to a door station call from the interior keypads. The reply can be made only by pressing and holding the Talk key.

When the Call key on a door station is pressed, each hub instructs all connected keypads that aren't in DND mode to activate their speaker relays and connects the audio bus to their amplifiers. If a doorbell chime is selected on hub 1, the chime is played through the speaker outputs on those keypads and through the internal speakers in the door stations.

INSTALLER SECTION

System Functions

Door station call *(cont'd)*

Pressing the Call key also causes the doorbell contacts to close for a minimum of 4 seconds to activate a separate doorbell or other device connected to the door station. The actual time varies with the doorbell selection on hub 1; the contacts remain closed for the duration of the selected chime.

Also, all keypads indicate which door station is calling, regardless of whether or not they're in DND mode. The indication remains for 15 seconds, during which the door station is selected at each keypad for reply.

Within the 15 seconds, a person at any keypad can then speak with the person at the door while holding in the Talk key. If the 15 seconds pass before the Talk key is pressed, the person inside will need to first select the door station on the keypad and then press the Talk key to start a new session. This will not activate the doorbell chime.

When a door call is answered from inside, the release of the Talk key at the keypad triggers a single ping at the door station to let the caller know they can reply. The person at the door station has a 7-second window for a hands-free reply after the single ping. The caller has the option of speaking within the 7 seconds or pressing and holding the Call key to speak longer. Holding in the Call key keeps the audio bus switched to the door station's microphone.

If the 7-second hands-free window ends before the caller presses the Call key to speak, the door station sounds a double ping indicating the audio bus has opened. At this point the caller must press the Call key again to request another session if they wish to speak longer. This also rings the doorbell again.

Door strike release

The optional ISDR1 Door Strike Release module can be activated from any keypad at any time. When activated, the module stays active for 3 seconds, confirmed by a buzz tone at the keypad and the door station.

On an ISK1 Basic Keypad, the module is activated by pressing and holding the appropriate door key for 3 seconds.

When a communication session is active between a door station and an ISK2 Advanced Keypad, the module can be activated by pressing and holding both the Previous and Next keys for 3 seconds. If no session is active, the door will first need to be selected on the keypad.

Listen mode

Listen mode is a system state in which one keypad has a constantly active microphone and one or more other keypads are receiving its audio signal. This mode is subject to temporary interruption when the system is used for paging, intercom, or door station sessions.

Selecting a keypad's own zone connects its microphone to the audio bus 2 seconds after the selection is made. That zone then becomes the sending zone for Listen mode. The keypad's Talk key lights up red to indicate the microphone is on. In addition, the zone key on an ISK1 Basic Keypad blinks red and the display on an ISK2 Advanced Keypad shows **MicOn**.

If another zone is already selected as a sending zone for Listen mode, the keys on the Basic Keypad for both the active zone and the desired zone alternately blink red for 7 seconds to indicate which zone's microphone is active. The Advanced Keypad alternately displays the active zone and **MicOn** for 7 seconds.

Listen mode (*cont'd*)

Selecting the sending zone on other keypads connects their amplifiers to the audio bus so they can listen to the sending zone.

Listen mode can be used with DND in the same zone as long as Listen mode is enabled first.

On either type of keypad, selecting a zone other than its own cancels Listen mode.

Because Listen mode is the lowest priority communication, it can be interrupted by other functions, including an intercom session from the Listen mode sending keypad. When Listen mode is interrupted, the sending and receiving keypads give a system busy indication until the interruption is over.

If the audio bus is not available, attempting to activate a keypad's microphone for Listen mode will result in a system busy indication.

Audible keypad volume level indication

When the audio bus is inactive, pressing the Volume Up or Volume Down key on a keypad sounds a ping tone to audibly indicate the keypad's output level. As volume is increased the ping tone gets louder and vice versa. Once the volume adjustment reaches either end of the range, the ping tone no longer sounds.

System busy

If someone attempts to start a page or intercom session when the system is busy, the Talk key on the keypad blinks red for 7 seconds to indicate the system is unavailable. The ISK2 Advanced Keypad display also flashes **Busy** at the same time.

Do Not Disturb (DND) mode

Placing a zone in Do Not Disturb (DND) mode prevents the audio bus from being switched to the keypad amplifier in that zone. Thus, that zone will not receive any pages, intercom calls, door station calls, or doorbell chimes (unless a separate doorbell is used). However, DND mode will not prevent the zone from receiving audio from a multiroom audio system.

The volume setting in effect when a zone is put in DND mode is retained when DND is canceled.

DND mode can be used in conjunction with Listen mode as long as Listen mode is selected first. If DND is selected first, pressing any key to enable Listen mode will exit DND mode.

When a zone attempts an intercom session with a zone that is in DND mode, the DND key on the sending keypad blinks red for 7 seconds after the Talk key is pressed. Also, on the ISK1 Basic Keypad, the zone key for the zone in DND mode blinks red.

Keypad backlight

The keypad backlighting comes on whenever any system function is activated and goes off after 60 seconds of system inactivity.

INSTALLER SECTION

System test

System function test

Paging

Initiate a page from any keypad

- Verify all keypads indicate the sending zone
- Verify the page is heard in all zones

Reply to a page from a receiving zone

- Verify communication with sending zone

Intercom

Initiate an intercom session

- Verify the receiving zone keypad indicates the sending zone
- Verify the message is heard in the receiving zone

Reply to initial message

- Verify hands-free operation within 7 seconds
- Verify reply with Talk key after 7 seconds
- Verify reply is heard in sending zone

Door station call

Initiate a door station call

- Verify all keypads indicate the door station
- Verify door chime (if selected)

Reply to door station call

- Verify reply is heard at door station

Answer reply from door station

- Verify hands-free operation within 7 seconds
- Verify operation with Call key after 7 seconds
- Verify answer is heard in replying zone

Door strike release

Initiate a door strike release

- Verify module activation
- Verify audible confirmation

Listen mode

Activate microphone in zone to be heard

- Verify keypad confirmation of microphone on

Select zone to be heard at another keypad

- Verify keypad indication of selected zone
- Verify audio transmission from zone with active microphone

Cancel Listen mode

- Verify clearing of Listen mode

Do Not Disturb mode

Enable DND mode on a keypad

- Verify no interruption by paging, intercom, or doorbell
- Verify DND indication on another keypad attempting to intercom to keypad in DND mode

Cancel DND mode on a keypad

- Verify clearing of DND mode

Troubleshooting chart

Symptom	Possible Cause	What to Do
Talk key flashes rapidly; Advanced Keypad indicates Wrong Connection shortly after powering system	Keypad connected to door station port or door station connected to keypad port on hub	Check keypad and door station connections at hub
	Door station connected to a hub other than hub 1	Check door station connections at hub
	Hub ID numbers not assigned	Assign a unique ID number for each hub
No response or backlight at any keypad	No power to hub(s)	Make sure a power supply is plugged into each hub and the AC circuit is energized
No response or backlight at one keypad; others work OK	Open power or ground wire in CAT-5 cable or bad termination	Check orange pair and terminations
	Programming jumper is shorting 2 pins on right edge of second circuit board	Remove programming jumper
	Faulty port on hub	Power down, swap connector to another port, power up; if keypad works OK, replace hub
No port indication on Advanced Keypad display when powering up	Open status wire in CAT-5 cable or bad termination	Check green wire and terminations
Keypad lights up but doesn't work; Advanced Keypad indicates only Page and initial volume	Open communication wire in CAT-5 cable or bad termination	Check blue pair and terminations
Keypad failed to register with hub (other keypads don't indicate this keypad's zone)	Open communication wire in CAT-5 cable or bad termination	Check blue pair and terminations
	Keypad was connected to hub while system was powered	Cycle power to hub(s) and wait 15 seconds before using keypads
No communication audio in one zone; speakers play music OK	Room speakers not properly connected to keypad	Make sure speakers are connected to keypad output connector
	Open audio wire in CAT-5 cable or bad termination	Check brown pair and terminations
Popping sound occurs before and after ping tone when Talk key is used or volume is adjusted	System has a bad keypad	Disconnect one keypad at a time until popping sound stops; replace keypad and cycle power
No doorbell chime	Chime not selected at hub	Select chime tone(s) on hub 1
Doorbell chime too loud/soft overall	Doorbell chime gain not adjusted	Adjust doorbell chime gain on hub 1
Doorbell chime too loud/soft in some zones, OK in others	Doorbell chime volume set to variable level and keypads set to different volume levels	Set doorbell chime volume switch to fixed level (1)
		Adjust keypad volume settings
Door strike release module doesn't operate	Open trigger wire in CAT-5 cable or bad termination	Check green/white wire and terminations
Assigned zone labels appear on some Advanced Keypads but not others	Multiple hubs not linked together	Link hubs and cycle power
	Hub 1 powered up too early (before other hubs)	Cycle power on hub 1 last

REFERENCE SECTION

Technical Specifications

System

Maximum zones: 36 (up to 6 hubs)
Door stations: 2 maximum
Communications cable: CAT-5/CAT-5e
Maximum cable length: 250 feet (76 m)

ISK1 Basic Keypad

User controls: 6 zone selection/indication keys
Talk key
2 door selection/indication keys
DND selection/indication key
Volume Up and Volume Down keys
Key backlighting: Installer-selectable amber or green, with red indication
Audio input: Built-in microphone with automatic gain control
Amplifier: Monaural (for system functions only)
Amplifier power: 2 watts
Min. load impedance: 6 ohms per channel
Speaker relay: 4-pole double-throw
Speaker relay rating: 50 watts RMS continuous
Speaker connector: 8-pole screw terminal
Speaker wire size: Up to 14 AWG (1.63 mm)
CAT-5 connector: 110 punch-down block
Power consumption: 15 VDC 800 mA maximum, 200 mA typical
Keypad style: Single-gang Decora®
Dimensions: 1.875" W x 4.188" H x 2.5" D (4.8 x 10.6 x 6.4 cm)
Weight: 4.8 oz (136 g)

ISK2 Advanced Keypad

Display: 5-character backlit LCD panel
User controls: Talk key
Next and Previous keys
DND selection/indication key
Volume Up and Volume Down keys
Backlighting: Installer-selectable amber or green, with red indication
Audio input: Built-in microphone with automatic gain control
Amplifier: Monaural (for system functions only)
Amplifier power: 2 watts
Min. load impedance: 6 ohms per channel
Speaker relay: 4-pole double-throw
Speaker relay rating: 50 watts RMS continuous
Speaker connector: 8-pole screw terminal
Speaker wire size: Up to 14 AWG (1.63 mm)
CAT-5 connector: 110 punch-down block
Power consumption: 15 VDC 800 mA maximum, 200 mA typical
Keypad style: Single-gang Decora®
Dimensions: 1.875" W x 4.188" H x 2.625" D (4.8 x 10.6 x 6.7 cm)
Weight: 5.6 oz (159 g)

ISK3 Door Station

User control: Call key with amber backlight
Audio input: Built-in microphone with automatic gain control
Amplifier: Monaural (for system functions only)
Amplifier power: 2 watts
Volume control: Installer-adjustable potentiometer
Audio output: Built-in speaker
Cover plate: Weatherproof plated die-cast zinc
CAT-5 connector: 110 punch-down block
Doorbell connector: 2-pole screw terminal
Doorbell wire size: Up to 18 AWG (1.024 mm)
Doorbell contact: 1 A @ 12 VDC
Power consumption: 15 VDC 220 mA maximum
Dimensions: 3" W x 5.125" H x 3.25" D (7.6 x 13.0 x 8.3 cm)
Dimensions in wall box: 2" W x 2.875" H x 2.75" D (5.1 x 7.3 x 7.0 cm)
Wall box required: Single-gang, 22 cu in (360 cm³) min
Weight: 8 oz (227 g)

ISH1 Hub

Keypad ports: (6) 8-pole modular RJ-45
Door station ports: (2) 8-pole modular RJ-45
Link ports: (2) 8-pole modular RJ-45
Firmware update port: 4-pole port for Programming Cable, Russound part #2500-521065
Switches: 4-switch DIP for hub ID setting
8-switch DIP for 2 doorbell settings
Potentiometer for doorbell volume
Doorbell options: 7 chime patterns plus no chime
Power requirement: 15 VDC 3.5 A (uses ISPS power supply)
Mounting method: Surface or structured wiring panel
Dimensions: 6.438" W x 5.125" H x 1.813" D (16.4 x 13.0 x 4.6 cm)
Weight: 25.6 oz (0.73 kg)

ISDR1 Door Strike Release Module

CAT-5 connectors: (2) 110 punch-down blocks
Strike release relay: 1-pole double-throw (NC/NO)
Relay connector: Removable 3-pole screw terminal
Relay wire size: Up to 14 AWG (1.63 mm)
Relay contact rating: 5 A @ 12 VDC
Mounting method: Surface
Dimensions: 3" W x 1.875" H x 1" D (7.6 x 4.8 x 2.5 cm)
Weight: 4.8 oz (136 g)

ISSP Speaker

Device style: Single-gang Decora®
Connection: Attached wire leads
Power rating: 2 watts nominal, 5 watts maximum
Impedance: 8 ohms
Dimensions: 1.65" W x 4.13" H x 1.42" D (4.2 x 10.5 x 3.6 cm)
Weight: 3 oz (85 g)

Warranty

The Russound ComPoint system components (ISH1, ISK1, ISK2, ISK3, ISDR1, and ISSP) are fully guaranteed for two (2) years from the date of purchase against all defects in materials and workmanship. For this warranty to apply, the components must be installed and used according to their written instructions. During this period, Russound will replace any defective parts and correct any defect in workmanship without charge for either parts or labor. Accidental damage and shipping damage are not considered defects under the terms of this warranty. Russound assumes no responsibility for defects resulting from abuse or servicing performed by an agency or person not specifically authorized in writing by Russound. If service is necessary, it must be performed by Russound. Damage to or destruction of components due to excessive power voids the warranty. In these cases, the repair will be made at the owner's expense. To return a product for repairs, the unit must be shipped to Russound at the owner's expense, along with a note explaining the nature of the service required. Be sure to pack in a corrugated container with at least 3 inches of resilient material to protect the unit from damage in transit.

Before returning a unit for repair, call Russound at 603.659.5170 for a Return Authorization number. Write the RA number on the shipping label and ship to: Russound, 5 Forbes Road, Newmarket NH 03857.

Russound sells products only through authorized dealers and distributors to ensure that customers obtain proper support and service. Any Russound product purchased from an unauthorized dealer or other source, including retailers, mail order sellers and online sellers will not be honored or serviced under existing Russound warranty policy. Any sale of products by an unauthorized source or other manner not authorized by Russound shall void the warranty on the applicable product.



ComPoint

The music lover's intercom solution

Instruction Manual

Models

ISH1

ISK1

ISK2

ISK3

ISDR1

ISSP

Russound
5 Forbes Road, Newmarket NH 03857 USA
Tel 603.659.5170 • Fax 603.659.5388
www.russound.com
Technical Support: tech@russound.com

28-1211 Revision 1 08/23/06

Copyright © 2006 Russound. All rights reserved. All trademarks are the property of their respective owners. Specifications are subject to change without notice. Russound is not responsible for typographical errors or omissions.