

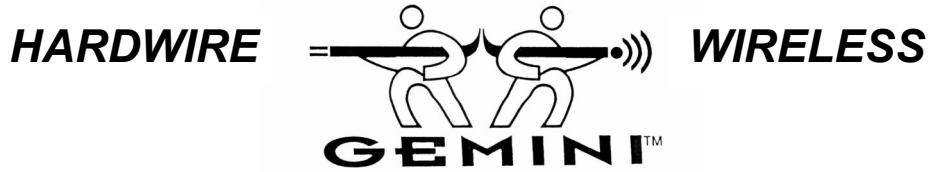

PROGRAMMING INSTRUCTIONS



GEM-P1632 CONTROL PANEL/COMMUNICATOR

Programming the GEM-P1632 Control Panel with the "Classic" GEM-RP2ASe2, GEM-RP3DGTL, and GEM-RP4RFC/GEM-RP4C Keypads and the "K Series" GEM-K2AS, GEM-K3DGTL, and GEM-K4/GEM-K4RF Keypads



"K Series" GEM-K3DGTL



"K Series" GEM-K2AS

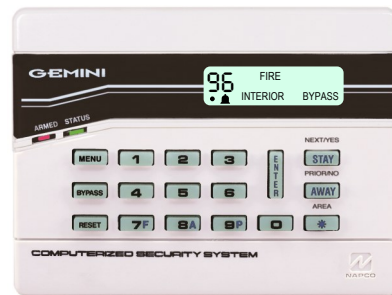

"K Series" GEM-K4/GEM-K4RF

Quick Start (for GEM-K2AS):

1. Refer to the wiring diagram, connect Siren, Aux. Power, PGM Output, Remote Bus, Earth Ground, Zone and Telephone Wiring. NOTE: See Installation Instructions (WI808).
2. Connect AC power first and then the battery.
3. Configure the keypad (see page 53).
4. Access the Easy Menu Driven (Dealer Program) Mode:



Press NO until "TURN ON PROG Y/N" appears on the keypad display.

Press NEXT/YES to enter Dealer Program Mode. See page 5.

Quick Start (for GEM-K3DGTL):

1. Refer to the wiring diagram, connect Siren, Aux. Power, PGM Output, Remote Bus, Earth Ground, Zone and Telephone Wiring. NOTE: See Installation Instructions (WI808).
2. Connect AC power first and then the battery.
3. Configure the keypad (see page 53).
4. Access the Easy Menu Driven (Dealer Program) Mode:

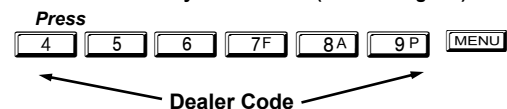

Press NO until "17" appears on the keypad display.

Press NEXT/YES to enter Dealer Program Mode. See page 5.

THIS MANUAL INCLUDES FEATURES WHICH ARE ONLY AVAILABLE IN CONTROL PANEL FIRMWARE VERSION 31 OR LATER.

CHANGES FROM PREVIOUS EDITION

The following changes have been made to this manual (WI1148E.aLF) since the previous edition (WI1148ELF):







- Changed UL references to accommodate both UL and ETL installations

Warning: The use of non-NAPCO wireless devices with this control panel has not been evaluated by UL or ETL and voids the UL or ETL listing. In addition, the performance of these devices can not be guaranteed as compatible with NAPCO control panels. *For systems that include CO detectors, the system must be monitored by a central station, and at least one model GEM-RP1CAe2 or GEM-K1 series 2-line LCD keypad must be used.*

IMPORTANT NOTE

This manual supports the keypad programming of the GEM-P1632 control panel with the NAPCO "classic" GEM-RP2ASe2, GEM-RP3DGTL and GEM-RP4RFC series keypads as well as the GEM-K2AS, GEM-K3DGTL and GEM-K4RF "K Series" keypads. The new "K Series" models offer the new STAY and AWAY buttons with simplified functionality, along with the new MENU and ENTER buttons. While the instructions in this manual are depicted using the "K Series" keypads, the manual applies to both the "classic" and the "K Series" keypads.

Program Mode is the same for both keypads--**only the button names have changed**, as follows:

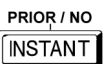
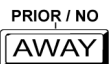
- The  button and the  button operate identically (in Program Mode) for both keypads.
- The  button and the  button operate identically (in Program Mode) for both keypads.
- The  button and the  button operate identically (in Program Mode) for both keypads. The words "NEXT/YES button" are used in this manual.
- The  button and the  button operate identically (in Program Mode) for both keypads. The words "PRIOR/NO button" are used in this manual.

 For consistency, it is recommended that all keypads either be all "classic" or all "K Series"--both keypad types should not be used in one alarm system.



NAPCO Security Technologies, Inc.
333 Bayview Avenue, Amityville, New York 11701
For Sales and Repairs, call toll free: (800) 645-9445
For direct line to Technical Service, call toll free: (800) 645-9440
Internet: <http://www.napcosecurity.com>

TABLE OF CONTENTS

SYSTEM PROGRAMMING OPTIONS	4	CS AREA & SYSTEM REPORTING OPTIONS.....	32
<i>Introduction</i>	4	CS ZONE REPORTING OPTIONS	33
<i>Downloading From a Computer</i>	4	CS USER REPORTING OPTIONS	34
EASY MENU DRIVEN PROGRAM MODE	5	CS USER REPORTING OPTIONS	35
<i>Dealer Program - Preliminary Information</i>	5	EZM GROUP OPTIONS	36
<i>Accessing Dealer Program Mode</i>	5	AREA ARMING OPTIONS	36
<i>Customizing a Default Program</i>	5	AREA BELL CONTROL OPTIONS	37
Easy Program Menu:		KEYPAD OPTIONS	41
<i>GEM-RP2ASe2/GEM-K2AS KEYPAD</i>	6	TEMPERATURE DISPLAY AT KEYPAD	42
<i>GEM-RP3DGTL/GEM-K3DGTL and</i>		ZONE OPTIONS - ZONES 1 TO 16	43
<i>GEM-RP4RFC/GEM-K4RF KEYPAD</i>	13	ZONE OPTIONS - ZONES 17 TO 32	44
DIRECT ADDRESS PROGRAM MODE	20	EXTERNAL RELAY CONTROL	47
<i>Keypad Programming Overview</i>	20	RF RECEIVER & SUPERVISORY TIMER	
<i>Accessing Direct Address Program Mode</i>	20	OPTIONS	50
<i>Keypad Address Program Mode Display</i>	21	CLEAR PROGRAM OPTIONS	51
<i>Direct Address Program Mode</i>		USER PROGRAM MODE.....	51
<i>Keypad Commands</i>	21	Preliminary Information	51
<i>Direct Address Programming Example</i>	22	Accessing User Program Mode	51
<i>Conventions Used in this Manual</i>	23	User Codes	52
SYSTEM DELAYS & TIMEOUTS	24	KEYPAD CONFIGURATION MODE.....	53
SYSTEM OUTPUT TIMEOUTS.....	25	Keypad Installation.....	53
DOWNLOAD/CALLBACK OPTIONS	25	Configuring the Keypads.....	53
PAGER FORMAT OPTIONS.....	25	ALPHABETICAL INDEX	54
SYSTEM OPTIONS	26	ADDRESS NUMBER LOCATION INDEX.....	59
GLOBAL AMBUSH CODE	26	GEM-P1632 WIRING DIAGRAM	64
SYSTEM OPTIONS.....	27		
CS RECEIVER OPTIONS	30		
CS SUBSCRIBER ID OPTIONS	31		
CS SYSTEM REPORTING OPTIONS	32		

Refer to accompanying GEM-P1632 Installation Instructions (WI808) for installation information.

NOTE: THESE PROGRAMMING INSTRUCTIONS ARE INTENDED AND WRITTEN FOR THE PROFESSIONAL INSTALLER HAVING SUITABLE EXPERIENCE AND INSTALLATION EQUIPMENT. THE UNIT IS DESIGNED TO BE PROGRAMMED USING AN IBM-COMPATIBLE COMPUTER WITH NAPCO PCD-WINDOWS SOFTWARE. AFTER PROGRAMMING, BE SURE TO RUN THE PCD-WINDOWS ERROR-CHECK UTILITY TO GUARD AGAINST PROGRAMMING CONFLICTS FOR THE TYPE OF SERVICE SELECTED FOR THE INSTALLATION.

SYSTEM PROGRAMMING OPTIONS

INTRODUCTION

The GEM-P1632 control panel may be programmed by various means, each of which will be covered in detail in the sections that follow. Keypad displays shown are for a GEM-K2AS, GEM-K3DGTL and GEM-K4RF series keypads. With the GEM-RP2ASe2 and GEM-K2AS keypads, because of their reduced display capabilities, messages are abbreviated and will scroll through two or more screens. Zone descriptions cannot be programmed using GEM-K2AS or GEM-RP2ASe2 keypad, therefore a GEM-RP1CAe2/GEM-K1CA must be used (see WI897).

- ✓ **Downloading From a Computer.** This is the preferred method of programming. The panel may be downloaded from (or uploaded to) an IBM PC-compatible computer, either locally or remotely. Napco's PCD-Windows Quickloader software features context-sensitive help screens as well as an error-checking utility that prevents programming of incompatible or conflicting data to ensure proper panel operation. **Note:** Unattended downloading from a computer is not allowed for Fire Alarm, UL or ETL installations.
- ✓ **Easy Menu-Driven Program (Dealer Program) Mode - Keypad Programming.** The Easy Menu-Driven Program Mode allows keypad programming of number of zones in area 1, panel zone doubling, number of fire zones (both 4-wire and 2-wire), local or Central Station reporting, number of exit/entry zones, number of interior zones, number of 24 hour zones, number of chime zones, Chime 2 zones, Exit/Entry2 zones, 50ms loop response zones (**Note: 750mS is required for Loop Response time in UL or ETL installations**), aux output activated on alarm zones, sensor watch zones, keypad sounder on alarm zones, auto bypass re-entry zones, EOLR zones, number of keypads in area 1, Central Station telephone number, Central Station account number, Central Station receiver format, User Codes, RF transmitter points, RF keyfob transmitters, zone descriptions, dealer code, Telco line fault test, Burg output chirp on keyfob, enable CP-01, and clear dealer program/cold start. For new panels, a custom default program may be created at the keypad. A menu-driven utility prompts the installer to configure the system. Further detailed customization is accomplished in the Direct Address Program Mode.
- ✓ **Direct Address (Dealer Program) Program Mode - Keypad Programming.** The Direct Address Program Mode is an extension of the Dealer Program Mode wherein data is entered at the keypad by specific location. This mode is accessed from the Easy Menu Driven Program Mode by pressing the **RESET** button at any time.
- ✓ **User Program Mode - Keypad programming.** The User Program Mode is intended for authorized users and is limited to keypad programming of User Codes.

DOWNLOADING FROM A COMPUTER

The control-panel program may be downloaded from the computer by any of the following methods.



Local Downloading

(**Note:** This procedure should be used after installation, after peripheral devices are connected).

For direct high-speed data transfer to the control panel from a desktop computer, connect the download jack (JP2) on the panel to the LOCAL jack (J3) on the Napco PCI2000/3000 computer interface using the supplied 6-conductor cable. (Refer to PCI2000/3000 Installation Instructions WI443 for wiring diagram and procedures).

Similarly, a high-speed local download may be made in the field using a notebook or laptop computer. Connect JP2 on the control panel to a Napco PCI-MINI computer interface using the 6-conductor cable supplied. (Refer to PCI-MINI Installation Instructions WI767).

Remote Downloading

(Also see PCI2000/3000 Installation Instructions WI443). **Note:** Unattended downloading from a computer is not allowed for Fire Alarm, UL or ETL installations.

Function Mode.

Start by establishing a Telco connection between the computer operator and the installer. During this procedure, voice contact will be lost, therefore both the installer and the computer operator should be familiar with the operation. When a steady high-pitched tone is heard at the site phone, access the "ACTIVATE DOWNLOAD" Function (see Keypad Programming Modes), then press the **ENTER** button or the YES button; the site phone will go dead.

Hang up the phone and wait for a call from the central station confirming a successful download.

Callback Method.

An installed, unattended panel may be programmed or reprogrammed remotely using the Callback-Method Download feature of the PCD Windows software. Remote downloading requires a modem compatible with the PCI2000/3000. Upon answering the call from the computer, the panel will verify the Download Security Code and, if confirmed, will establish a connection. If a Callback Number is programmed into the panel, the panel will automatically disconnect and call the computer at this number before establishing a connection.

EASY MENU DRIVEN PROGRAM MODE

DEALER PROGRAM - PRELIMINARY INFORMATION

- ☞ The Default Dealer Code is . Use this code to enter the Dealer Program Mode to program a custom Dealer Code, which replaces the Default Dealer Code. If you clear your Dealer Code, use the Default Dealer Code once again to enter programming.
- ☞ After entering codes or data, press the save button. **Data will not be stored into memory unless is pressed.**
- ☞ If the keypad is in the Program Mode and no activity is detected for longer than 4 minutes, a steady tone will sound.
- ☞ Silence the sounder by the button to continue, or by pressing the button to exit.
- ☞ When programming a Multiple Area System, Direct Address Programming Mode must be used to complete the program.

ACCESSING DEALER PROGRAM MODE

1. Press

↙ Dealer Code (Default = 456789) ↘

2. Press "PRIOR/NO" button until "TURNON PROG Y/N" (GEM-RP2ASe2 / GEM-K2AS) or "17" (GEM-RP3DGTL / GEM-K3DGTL or GEM-RP4RFC / GEM-K4RF) appears on the LCD screen.

3. Press "NEXT/YES" button to Enter Dealer Program Mode.

4. Press to exit Dealer Program Mode when finished.

CUSTOMIZING A DEFAULT PROGRAM

For new panels, you can design a default program that will best suit your application. Using this procedure, you will configure the panel for:

- Number of Zones in Area 1
- Panel Zone Doubling
- Fire Zones in Area 1
- 2-Wire Fire Zones in Area 1
- Local or Central Station Reporting System
- Exit/Entry Zones in Area 1
- Interior Zones in Area 1
- 24 Hour Zones in Area 1
- Chime Zones in Area 1
- Chime 2 Zones in Area 1
- Exit/Entry2 Zones in Area 1
- 50mS Loop Response Zones (Note: 750mS is required for Loop Response time in UL or ETL installations)
- Aux Output Activated on Alarm Zones
- Sensor Watch Zones
- Keypad Sounder on Alarm Zones
- Auto Bypass re-entry Zones
- Enable no EOLR Zones
- Enable Telco Line Fault Test
- Enable Burg Output Chirp on Keyfob
- Enable CP-01
- Number of Keypads in Area 1
- Central Station Receiver 1 Tel. Number
- Central Station Receiver 1 Account Number
- Central Station Receiver 1 Format
- Enter User Codes
- RF Transmitter Points
 - Quick Enroll Method
- Keyfob Transmitters
- Enter Zone Descriptions
- Dealer Code

This procedure will automatically set up system keypads, EZMs, wireless transmitters, etc. After your basic default program has been loaded, you may alter it as necessary in the Direct Address Program Mode.

NEW PANELS: The custom default program may be created for new panels only. Once the panel has been programmed by any means, the number zones will be suppressed and cannot be changed. Should it be necessary to create a new custom default program, (a) from the Dealer Program Mode, press the button to enter the Direct Address Program Mode; (b) access Location 2285 (Clear Program); (c) press the button and start over.

GEM-RP2ASe2/GEM-K2AS Keypad Easy Program Menu

Enter the Dealer Security Code (default = 456789) for a new panel or enter your custom Dealer Program Code if programmed. Press the PRIOR/NO button repeatedly until "TURNON/PROG" is displayed. **NOTE:** If you pass "TURNON/PROG", you can scroll back by pressing **[BYPASS]**. Press the NEXT/YES button to enter the Dealer Program Mode. In each of the following steps, press **[MENU]** to jump to the next screen, the NEXT/YES button to go forwards, the PRIOR/NO button to go backwards, **[ENTR]** to save and press **[RESET]** twice to exit at any time.

Ent A1

#ZnXX

(Direct Entry)

Total Number of Zones in Area 1 (Appears for New Panel Only)

Directly enter the total number of zones to be programmed for Area 1. Valid entries are from 01 to 32. Directly enter the total number of zones, including leading zeros. Use number buttons **[1]** through **[9P]**. **NOTE:** Press **[0]** for a zero. The system is based on groups of 4 zones each (after the first 8 zones), and will automatically round up to the next group of 4. For example, if you enter 10, it will automatically convert this to 12 zones. Press **[ENTR]** to save. Press the NEXT/YES button to proceed. **NOTE:** If you are programming a 2 Area system, enter the total number of zones required for Areas 1 & 2. The Direct Address Program Mode can then be used to remove zones from Area 1 and place them in Area 2. See Zone Options. If Programming a *Wireless-Only* system, or using *Wireless-Only* on Zones 9-32, enter the total number of zones in system. Enter the transmitter points in the RF Transmitter section of the Easy Menu Driven Programming Mode.

Zn Dbl

Enabl?

Y/N

(Press YES or NO)

Panel Zone Doubling (Appears for New Panel Only)

If the total number of zones in Area 1 entered was 16 or greater, press the NEXT/YES button to effectively double the capacity of the control panel's hard wired zones from 8 to 16. The 16 zones will remain EOL terminated zones, but will be designated for Normally Closed devices only. The terminal for Zone 1 will now support Zones 1 and 9 with the use of the supplied EZ Zone Doubling™ resistors, E & Z supplied. (Refer to Wiring Diagram and Installation Instructions). If Panel Zone doubling is not desired, press the PRIOR/NO button.

Ent Fr

Zn#XX

(Direct Entry)

Fire Zones in Area 1 (Appears for New Panel Only)

Enter the zone number of any zones which are to be used as Fire Zones (both 2-wire, 4-wire or wireless). Valid entries are from 01 to 32. Directly enter each zone number, including leading zeros, and press **[ENTR]** to save, and then repeat for any additional zone(s). Press NEXT/YES button to proceed.

NOTE: If you are programming a 2 Area system, enter all the zone numbers required for Areas 1 & 2. The Direct Address Program Mode can then be used to remove zones from Area 1 and place them in Area 2. See Zone Options.

Ent2WF

Zn#XX

(Direct Entry)

2-Wire Fire Zones in Area 1 (Appears for New Panel Only)

Enter the zone numbers of any Fire Zones (from previous question) which are to be used with 2-wire smoke detectors. The only valid entries are 07 and 08. Directly enter each zone number, including leading zeros. Press **[ENTR]** to save, and then repeat for any additional zone(s). **NOTE:** Only zones which have been designated as Fire Zones in the prior question may be programmed as 2 Wire Fire zones. Press the NEXT/YES button to proceed.

NOTE: JP3 must be set to "2-WF" position for 2-wire fire zones (refer to Installation Instructions).

Report

all Zn

Y/N

(Press YES or NO)

Local or Central Station Reporting System (Appears for New Panel Only)

Press the NEXT/YES button for all zones to report; press the PRIOR/NO button for no zones to report (LOCAL SYSTEM).

EntEE1

Zn#XX

(Direct Entry)

Exit/Entry Zones in Area 1 (Appears for New Panel Only)

Directly enter the zone number of any zones which are to be used as Exit/Entry zones. Valid entries are from 01 to 32. Directly enter each zone number, including leading zeros. Use number buttons **[1]** through **[9P]**.





NOTE: Press the **[0]** button for a zero. Press **[ENTR]** to save and then repeat for any additional zone(s). Press the NEXT/YES button to proceed.

NOTE: Chime will automatically be programmed for all E/E zones. If you are programming a multiple area system, enter all exit/entry zone numbers required for Areas 1 & 2. The Direct Address Program Mode can then be used to remove zone from Area 1 and place them in Area 2. See Zone Options.

EntFol
Zn#XX

(Direct Entry)

Interior (Stay) Bypass Zones in Area 1 *(Appears for New Panel Only)*

Directly enter the zone number of any zones which are to be used as Interior Follower Zones. Valid entries are from 01 to 32. Directly enter each zone number, including leading zeros. Use number buttons  through . **NOTE:** Press  for a zero. Press  to save and then repeat for any additional zone(s). Press the NEXT/YES button to proceed. **NOTE:** All Interior Follower zones will also be automatically programmed as "Exit/Entry Follower" and "Power Up Delay" zones. If you are programming a multiple Area system, enter the total number of zones required for Areas 1 & 2. The Direct Address Program Mode can then be used to remove zones from Area 1 and place them in Area 2. See Zone Options.

Ent24H
Zn#XX

(Direct Entry)

24 Hour Zones in Area 1 *(New Program Only)*

- Enter the zone numbers of zones to be used as 24 Hour zones.
- Valid entries are from 01 to 32. Directly enter each zone number, including leading zeros.
- Press  to save and repeat for any additional zone(s); press the NEXT/YES button to proceed.

EntCZ1
Zn#XX

(Direct Entry)

Chime Zones in Area 1 *(New Program Only)*

- Enter the zone numbers which are to be used as Chime Zones.
 - Valid entries are from 01 to 32. Directly enter each zone number, including leading zeros.
 - Press  to save and then repeat for any additional zone(s), press the NEXT/YES button to proceed.
- NOTE:** A chime time of 2 seconds will be automatically programmed.

EntCZ2
Zn#XX

(Direct Entry)

Chime 2 Zones in Area 1 *(New Program Only)*

- Enter the zone numbers which are to be used as Chime 2 Zones.
 - Valid entries are from 01 to 32. Directly enter each zone number, including leading zeros.
 - Press  to save and then repeat for any additional zone(s), Press the NEXT/YES button to proceed.
- NOTE:** A chime time of 2 seconds will be automatically programmed.
Chime 2 zones give a distinct pulsating tone when zone is faulted.

EntEE2
Zn#XX

(Direct Entry)

Exit/Entry2 Zones in Area 1 *(New Program Only)*

- Enter the zone numbers of zones to be used as Exit/Entry 2 zones.
 - Valid entries are from 01 to 32. Directly enter each zone number, including leading zeros.
 - Press  to save and repeat for any additional zone(s); press the NEXT/YES button to proceed.
- NOTE:** An Exit/Entry 2 Entry Time of 30 sec. will automatically be programmed.

Ent50m
Zn#XX

(Direct Entry)

50 mS Loop Response Zones *(New Program Only)*

- Enter the zone numbers of zones to be have a 50mS loop response. **Note:** Time can also be adjusted via address 2280. **Note: 750mS is required for Loop Response time in UL or ETL installations.**
- Valid entries are from 01 to 08. Directly enter each zone number, including leading zeros.
- Press  to save and then repeat for any additional zone(s), Press the NEXT/YES button to proceed.

EntAux
Zn#XX

(Direct Entry)

AUX Output Activated on Alarm Zones *(New Program Only)*

- Enter the zone numbers of zones to activate the PGM2 output upon alarm.
 - Valid entries are from 01 to 32. Directly enter each zone number, including leading zeros.
 - Press  to save and then repeat for any additional zone(s), Press the NEXT/YES button to proceed.
- NOTE:** An Aux Output Timeout of 15 Minutes will automatically be programmed.

Ent SW
Zn#XX

(Direct Entry)

Sensor Watch Zones *(New Program Only)*

- Enter the zone numbers of zones to be Sensor Watch zones.
 - Valid entries are from 01 to 32. Directly enter each zone number, including leading zeros.
 - Press  to save and then repeat for any additional zone(s), Press the NEXT/YES button to proceed.
- NOTE:** A Sensor Watch Time of 24 hours will automatically be programmed.

EntKPS
Zn#XX

(Direct Entry)

Keypad Sounder On Alarm Zones *(New Program Only)*

- Enter the zone numbers of all zones to activate the Keypad Sounder upon alarm.
- Valid entries are from 01 to 32. Directly enter each zone number, including leading zeros.
- Press  to save and then repeat for any additional zone(s), press the NEXT/YES button to proceed.

EntAUB
Zn#XX

(Direct Entry)

Auto Bypass Re-entry Zones (New Program Only) *(Not evaluated by UL or ETL)*

- Enter the zone numbers of zones to be Auto Bypass Re-entry zones.
- Valid entries are from 01 to 32. Directly enter each zone number, including leading zeros.
- Press  to save and then repeat for any additional zone(s), press the NEXT/YES button to proceed.
- Auto Bypass Re-entry Zones allow the system to be armed with the zone faulted but come back into the system (armed) when the zone is subsequently secured.

EnNEOL
Y/N

(Press YES or NO)

Enable No EOLR Zones (New Program Only)

- Press the NEXT/YES button to program all zones except 24 Hr & fire zones for No End Of Line Resistor. Press the PRIOR/NO button to continue. **NOTE:** Do not program this feature for UL or ETL Installations.

Telco
Ln Fit
Y/N

(Press YES or NO)

Enable Telco Line Fault Test? (New Program Only)

- Press the NEXT/YES button to enable Telco Line Fault Test.
 - Press the PRIOR/NO button to continue.
- NOTE:** If enabled, a Telco Line Fault Test Delay of 60 seconds will automatically be programmed.

KF Out
Chirp
Y/N

(Press YES or NO)

Enable Burg Output Chirp on KeyFob? (New Program Only)

- Press the NEXT/YES button to enable Burg Output Chirp on KeyFob Arm / Disarm.
 - Press the PRIOR/NO button to continue.
- NOTE:** The Burg Output will chirp once on Keyfob Arm and twice on Keyfob Disarm.

Enable
CP01?
Y/N

(Press YES or NO)

Enable SIA CP01? (New Program Only)



- Press the NEXT/YES button to enable.
- Press the PRIOR/NO button to continue.



The SIA CP-01 Features are designed to reduce the incidence of false alarms. See WI808, "Installer Programming Quick Reference Chart SIA False Alarm Reduction" and "GEM-P1632 Factory Default Description" for more information. **NOTE:** Do not enable unless reporting, otherwise system trouble *Fail to Communicate* may occur.

Ent A1
#KP 01

(Direct Entry)

Number of Keypads in Area 1











Directly enter the total number of Keypads to be installed in Area 1. Valid entries are from 01 to 07. Directly enter the number of keypads, including leading zeros. Use number buttons  through . **NOTE:**

Press  for a zero. Press  to save. Press the NEXT/YES button to proceed. **NOTE:** Area 2, 3 or 4 keypads can only be assigned in Direct Address Programming. See Keypad Options.

Phone#

(Direct Entry)

Central Station Receiver 1 Telephone Number

Using number buttons, enter telephone number of up to 16 digits including prefix letters, if necessary, for receiver 1. Use number buttons  through  for digits 1–9; press the   buttons for a zero and   through   for letters B–F, respectively. **NOTE:** Pre-Dial Delay = "D"; Dial-Tone Detection = "E". Pressing  will produce a blank space (*). Press  to save. Press the NEXT/YES button to proceed.

NOTE: Central Station Receiver 2 and 3 Telephone Numbers can only be entered in Direct Address Programming. See CS Receiver Options.

Acc #
[_ _ _]

(Direct Entry)

Central Station Receiver 1 Account Number

Enter an account number of up to four digits. Use number buttons **[1]** through **[9 P]** for digits 1–9. **NOTE:**

Press the **[*]** **[0]** buttons for a zero and press **[0]** for a blank space (*). Press **[]** to save. Press the NEXT/YES button to proceed.

NOTE: Central Station Receiver 2 and 3 Account Numbers can only be entered in Direct Address Programming. See CS Reporting Options.

RecFmt
()

(Direct Entry)

Central Station Receiver 1 Format

From the table below, enter the central station's receiver format. Use number buttons **[1]** through **[9 P]**.

NOTE: Press the **[*]** **[0]** buttons for a zero and press **[0]** for a blank space (*). Press **[*]** **[1]** through **[*]** **[4]** for letters B–E, respectively. Press **[]** to save. Press the NEXT/YES button to proceed.

NOTE: Central Station Receiver 2 and 3 Formats can only be entered in Direct Address Programming. See CS Receiver Options.

DATA ENTRY	CS RECEIVER 1 FORMAT
•(blank)	Ademco Slow, Silent Knight Slow
2	Radionics Fast
3	Silent Knight Fast
4	Radionics, DCI, Franklin Slow

DATA ENTRY	CS RECEIVER 1 FORMAT
5	Universal High Speed
B	SIA
C	Ademco Point ID
E	Pager

User01

(Direct Entry)

Enter User Codes (Press the **[]** button to set cursor.)

For default program, enter up to 32 User Codes, with Area 1 and Area 2 Options.

Press **[]** once to set the cursor to the User Code. Use the number buttons **[1]** through **[9 P]** to enter a code from 3 to 6 digits. Enter up to 6 digits (4 digits is recommended) in the first six boxes from left to right for each user code. Valid entries are: 0-9. **NOTE:** Press **[0]** for a zero and press **[*]** **[0]** for a blank space (*). No blank spaces in between; leave blank (*) any trailing boxes. If "Enable Global Ambush Code" (Address 0720) is enabled and "Global Ambush Code" (Address 1054) is **not** left blank(*), *do not* program the first two digits of ANY User Code the same as the "Global Ambush Code". **Note:** If the programmed code was less than 6 digits, press **[]** to set the cursor to the Area 1 Options Level (OPT). Refer to the table on the next page for the available area options. **Note:** Duplicate User Codes are not allowed; therefore a duplicate Code entered in the LCD Window will erase when **[]** is pressed.

Note: The factory default settings in version 30M+ firmware include:

- Users 1-15 are pre-assigned to Arm/Disarm Area 1; User 1 is assigned User Code "1 2 3".
- Users 20-29 are pre-assigned to Arm/Disarm Area 2

OPT --

(Direct Entry)

ACC --

(Direct Entry)

USER OPTIONS											
USER CODE (UP TO 6 DIGITS)						AREA 1 OPTIONS			AREA 2 OPTIONS		

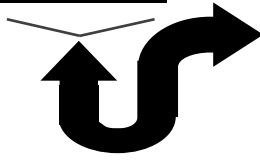

USER AREA OPTIONS		
DATA ENTRIES		OPTION ENABLED
L	R	
blank(*)	blank(*)	Disabled
blank(*)	1	Arm/Disarm
blank(*)	2	Arm Only
blank(*)	3	Service
blank(*)	4	Access
blank(*)	5	Ambush
blank(*)	Add 8	* User Program
4	blank(*)	Bypass Enable

AREA OPTIONS: Area 1 and Area 2 Options may be programmed for all 32 users.

Select the desired Area Options (Area 1-and 2) from the table shown and enter in the remaining four boxes for each user code.

Example: Program a code of "2222" for user 02, with area 1 options of "Arm/Disarm" and "User Program". Enter "2222" for a user code, "(blank) 9" for area 1 options and "(blank) (blank)" for area 2 options.

AREA OPTIONS	EXPLANATION
Disabled	User Code not active in this area.
Arm/Disarm	Allows User Code to arm/disarm this area.
Arm Only	Prevents User Code from disarming this area.
Service	A Service Code has restricted arm/disarm rights; if an area is armed with a Service Code, a "MONITOR ON" appears on the GEM-RP2ASe2 keypad and the area can be disarmed with any valid User Code, including a Service Code. If the area is armed with OTHER than a Service Code, it CANNOT be disarmed with a Service Code. This is typically used to allow tradesmen access to premises under control of the owner.
Access	This is normally used to activate a door strike while an area is disarmed. Also program "Access Control on PGM2 Output" (Address 0719) and "PGM2 Output Access Control Timeout" (Address 0711).
Ambush	There are two types of Ambush Codes: (1) A 2-digit code (prefix) that is entered immediately prior to (and as part of) the regular User Code and (2) A separate and unique User Code. Disarming with an Ambush Code will cause a silent report to be sent to a central station. Thus, should a user be forced to disarm, he can silently signal an emergency while appearing to be merely disarming the system.
* User Program	User Program Option is enabled for Keypad 1 only, wherever it is connected (Area 1 or Area 2). To enable User Program Option for any user add 8 to the data entry for Area 1 Option (see example). Then, User Programming can be performed only at Keypad 1 by a user code with user program enabled.
Bypass Enable	Security Bypass-Bypass is enabled only with a security code.

For Area 2 Options (ACC), press **FUNCTION** again. Refer to the table above for available options. **NOTE:** Press **0** for blank space (*).

Press **ENTER** to save. To proceed to the next User Code, press **MENU** to set the cursor to the User Number and change it using the number buttons.

Program a new User Code as previously described. Remember to record your user codes in the *Easy Menu Programming Worksheet* at the back of this manual.

Related User Options: "Enable Global Ambush Code" (Address 1422) and "Global Ambush Code" (Address 2045).

CHANGING OR CANCELING A CODE: To change any code, merely program over the existing code as described above and press **ENTER** to save. Similarly, to cancel a code, blank out each number of the code press **ENTER** to save.

Zn# 01

000000

(Direct Entry)

:0 Ft

(Direct Entry)

RF Transmitter Points (Press the **MENU** button to set cursor.)

(For wireless systems only. Also see Quick Method, which follows)

For each transmitter (keyfob transmitters also), enter the **zone number** (01–32) to which the transmitter will be mapped, the **6-digit RF ID #:1-digit checksum number** printed on the transmitter and box, the **point number** (1 or 2); enter "9" for *unsupervised* (all points). **NOTE:** When programming the ID Code number, "0" through "9" = **0** through **9P**; "A" = ***** **0**; "B" = ***** **1**; "C" = ***** **2**; "D" = ***** **3**; "E" = ***** **4** and "F" = ***** **5**. Press **ENTER** to save. Press the NEXT/YES button to proceed.

Quick Enroll Method.

If a receiver is already installed in the panel, Napco transmitter wireless points can be programmed automatically ("enrolled") using the following procedure. **NOTE:** The transmitter point will be enrolled only if the signal strength is 3 or greater.

1. Enter the zone number to which the transmitter point will be mapped.
2. Press the **BYPASS** button to enter the Enroll Mode. The red and green LEDs on the keypad will flash.
3. Open the loop of the point that is to be programmed (GEM-TRANS2 only).
4. Install the transmitter battery. The keypad will beep to indicate that the point has been successfully enrolled. Multi-point transmitters can be mapped to successive zones simultaneously (see example).

Example. A 2-point transmitter has the RF ID number 287613:1. Map point 1 to Zone 6 and point 2 to Zone 9.

1. Enter the Enroll mode as described above.
2. Enter Zone "06".
3. Open point-1 loop.
4. Install the battery. The keypad will beep once to indicate that one point has been programmed. (Transmitter 287613:1, point 1 will be mapped to Zone 6).
5. Enter Zone "09".
6. Close point-1 loop and open point-2 loop.
7. Remove the transmitter battery, then re-install it. The keypad will beep once to indicate that one point has been programmed. (Transmitter 287613:1, point 2 is mapped to Zone 9).

KEYFOB ZONE ASSIGNMENT: Keyfobs can also be assigned to zones to allow multiple wireless panic buttons on one alarm system, each reporting to a central station, a pager or having a description on the keypad that describes the person holding the keyfob, the location where the person holding the keyfob is stationed, or the special purpose of the keyfob button being depressed. See *Keyfob Transmitters as Zone Input Devices*.

KFob01

(Direct Entry)

Area

000000

(Direct Entry)

:0 0 0

(Direct Entry)

Keyfob Transmitters as Arm/Disarm & Control Devices

(Press **MENU** to set cursor).

Keyfobs can be programmed as "Arm/Disarm" devices using their On/Off buttons (refer to WI752). For each Keyfob Transmitter, enter:

- The **Keyfob Transmitter number** (01–08). Press **0** **1** through **0** **8A** for 01-08.
- **Area number** to which transmitter is assigned (0 to disable keyfob, 1 or 2). Press **0**, **1** and **2** for 0, 1 and 2, respectively.
- The **6-digit RF ID #** printed on the transmitter (enter all numbers and/or letters, including leading "0"s, if any): "0" through "9" = **0** through **9P**; "A" = *** 0**; "B" = *** 1**; "C" = *** 2**; "D" = *** 3**; "E" = *** 4** and "F" = *** 5**.
- 1-digit checksum number printed on the transmitter.
- **Aux 1 Option** (see keyfob aux 1 & aux 2 options).
- **Aux 2 Option** (see keyfob aux 1 & aux 2 options).
- For Aux 1/Aux 2 Options: "0", "1", "2" and "9" = **0**, **1**, **2** and **9P**, respectively; "A" = *** 0**; "B" = *** 1**; "C" = *** 2** and "D" = *** 3**.

DATA ENTRY	AUX 1/AUX 2 OPTIONS
0	None
1	Relay Group 1 Toggle
2	Relay Group 2 Toggle
9	Keypad Panic
A	Keypad Aux.
B	Instant
C	PGM2 Ouput Toggle
D	Access on PGM2 Output
E	Arm Stay
F	Interior Button

If the Keyfob is converted for Two Button "Emergency Use" (by cutting an internal jumper), both top or bottom buttons must be depressed to activate an alarm. In this case, the Aux-1 and Aux-2 cannot be programmed. Press **MENU** to save. Press the NEXT/YES button to proceed. **NOTE:** Keyfobs 1-8 report openings and closings as Users 25-32.

Keyfob Transmitters as Zone Input Devices

(refer to display as shown above: press the PRIOR/NO button to go backwards).

Each of the 4 keyfob buttons can be assigned to a zone. For example, On button = point 1; Off button = point 2; A1 = point 3; A2 = point 4. Up to 32 keyfobs (using 1 button) or 16 keyfobs (using 2 buttons) or 8 keyfobs (using all 4 buttons) or any combination up to a maximum of 32 controlled zones can be assigned, providing multiple wireless panic buttons on a system, each reporting to a Central Station or a pager and/or annunciating on a keypad the keyfob zone number with description/location. To assign a keyfob to a zone: program the keyfob as you would a transmitter, entering the keyfob's ID code, check sum and point number at the appropriate zone. The "Quick Method" is not allowed. The zone may be hardwired to an electrical sensor as well as assigned to a keyfob (either one will activate the zone alarm output). **NOTE:** If assigning a keyfob to a zone, the "ON/OFF" buttons on the keyfob will no longer arm/disarm the system. The keyfob is converted to a "panic only" device.

ZONE DESCRIPTIONS: GEM-RP2ASe2 cannot be used to enter Zone Descriptions. To enter Zone Descriptions, you must use the *GEM-RP1CAe2 Keypad / GEM-K1CA Keypad (See WI897) or the Napco PCD-Windows Quickloader Software.*

D Code

(Direct Entry)

456789

(Direct Entry)

RE-ENT

(Direct Entry)

Dealer Code

Directly enter the Dealer Code (default = 456789), including leading zeros. Use the **1** through **9P** buttons. **NOTE:** Press **0** for a zero. Press **MENU** to save. Re-enter the Dealer Code to verify the previous code. Press **MENU** to save. Press the NEXT/YES button to proceed.

EXIT DEALER PROGRAM MODE: This completes the custom default program. Press the **RESET** button to enter the Direct Address Program Mode for further programming or press **RESET** once again to end all programming and resume normal keypad operation.

CLEAR PROGRAM: Should it be necessary to create a new custom default program, (a) from the Dealer Program Mode, press **RESET** to enter the Address Program Mode; (b) access Location 2285 (Clear Program) or 2286 (Cold Start); (c) press **ENTER** and then (d) press **RESET** to exit the Dealer Program Mode. A "SYSTEM TROUBLE/E09-00 SERVICE" will occur. Enter your User Code and press **RESET** to silence the keypad.

2285 XX

(Direct Entry)

Clear Dealer Program (Erases Dealer Program)

This *erases the dealer program*. Use this feature to start a customized default program. Program Data and System Status Memory is erased where Scheduled Data and Zone Descriptions are maintained.

Access address 2285, then press the **ENTER** button. Data entry is not allowed. **NOTE:** Enter Easy Menu Driven Program Mode to program system again.

2286 XX

(Direct Entry)

Cold Start (Erases Entire Program)

This erases the entire program including Dealer Program by erasing Program Data, Zone Description Data and System Status Data (similar to a new panel).

Access address 2286, then press the **ENTER** button. Data entry is not allowed. **NOTE:** Some features (schedules) can only be programmed again with the Downloading Software.

GEM-RP3DGTL/GEM-K3DGTL and GEM-RP4RFC/GEM-K4RF Keypad Easy Program Menu

Enter the Default Dealer Program Code ("456789") for a new panel or enter your custom Dealer Program Code if programmed. Press **[MENU]**, followed by **[PRIOR/NO]** repeatedly until "17" is displayed (you can scroll back by pressing **[BYPASS]**). Press **[NEXT]** to enter Dealer Program Mode. For the GEM-RP3DGTL/GEM-K3DGTL (and GEM-RP4RFC/GEM-K4RF), questions are in the form of a 2-digit number flashing in the display. Press **[MENU]** to set the cursor into the next field to answer the question. Press **[MENU]** again to scroll through each segment. Press **[NEXT]** to go to the next question. To review your Easy Program Mode responses (before pressing **[NEXT/YES]** to save), press **[MENU]** until the 2-digit question number flashes in the display again. If the data is correct, press **[NEXT/YES]** to save. If the data is incorrect, press **[MENU]** to set the cursor into the next field and again enter your data. **Note:** Review your Easy Program Mode responses after the initial programming of the control, except for questions marked "For New Panel Only". These questions set up the basic structure of the panel program ("Number of Zones in an Area", etc.) and cannot be viewed or altered once set. To exit the Dealer Program Mode, press **[RESET]** twice to resume normal keypad operation. To return the panel to the factory default, enter the Direct Address Program Mode, go to location 2286 and press **[RESET]**.

Flashing



(Direct Entry)



(Press YES or NO)

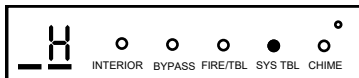
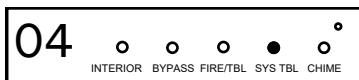

(Direct Entry)

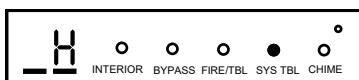
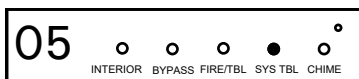

(Direct Entry)

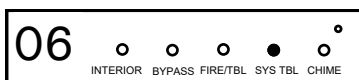

(Press YES or NO)

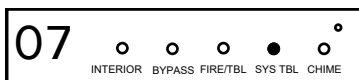

(Direct Entry)

Total Number of Zones (Appears for New Panel Only)

Directly enter the total number of zones to be programmed. Valid entries are from 01 to 32. Directly enter the total number of zones, including leading zeros. Use number buttons **[1]** through **[9P]**.

NOTE: Press the **[0]** button for a zero. The system is based on groups of 4 zones each (after the first 8 zones), and will automatically round up to the next group of 4. For example, if you enter 10, it will automatically convert this to 12 zones. Press **[NEXT/YES]** to save. Press the **[NEXT/YES]** button to proceed.

Panel Zone Doubling (New Program Only)

- To double the number of hardwired panel zones from 8 to 16, press the **[NEXT/YES]** button.
- If Panel Zone doubling is not desired, press the **[PRIOR/NO]** button.
- The 16 zones will remain EOL terminated zones, requiring Normally Closed devices only.
- Refer to Wiring Diagram and Installation Instructions for wiring instructions

Fire Zones (Appears for New Panel Only)

Enter the zone number of any Fire Zones (both 2-wire, 4-wire or wireless). Valid entries are from 01 to 32. Directly enter each zone number, including leading zeros, and press **[NEXT/YES]** to save, and then repeat for any additional zone(s). Press the **[NEXT/YES]** button to proceed.

NOTE: If you are programming a multiple Area system, enter the zone number of zones required for Areas 1 & 2. The Direct Address Program Mode can then be used to remove zones from Area 1 and place them in Area 2. See Zone Options.

2-Wire Fire Zones (Appears for New Panel Only)

Enter the zone number of any Fire Zones (from previous question) which are to be used with 2-wire smoke detectors. The only valid entries are 07 and 08. Directly enter each zone number, including leading zeros. Press **[NEXT/YES]** to save, and then repeat for any additional zone. **NOTE:** Only zones which have been designated as Fire Zones can be programmed as 2 Wire Fire zones. Press the **[NEXT/YES]** button to proceed. **NOTE:** JP7 must be set to "2-WF" position for 2-wire fire zones 7 and 8 (refer to Installation Instructions).

Local System or C.S. Reporting System (Appears for New Panel Only)

Press the **[NEXT/YES]** button for all zones to report; press the **[PRIOR/NO]** button for no zones to report (LOCAL SYSTEM).

Exit/Entry Zones (Appears for New Panel Only)

Directly enter the zone numbers which are to be used as Exit/Entry zones. Valid entries are from 01 to 32. Directly enter each zone number, including leading zeros. Use number buttons **[1]** through

[9P]. **NOTE:** Press the **[0]** button for a zero. Press **[NEXT/YES]** to save and then repeat for any additional zone(s). Press the **[NEXT/YES]** button to proceed.

NOTE: Exit/Entry Zones will have an entry delay of 30 seconds and an exit delay of 60 seconds.

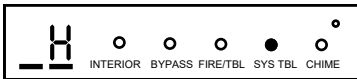
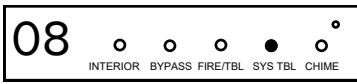

(Direct Entry)

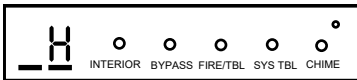

(Direct Entry)

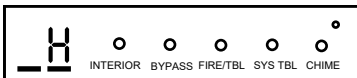

(Direct Entry)

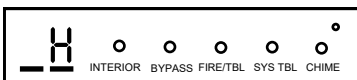
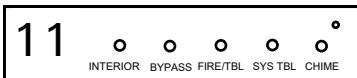

(Direct Entry)

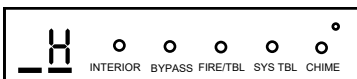
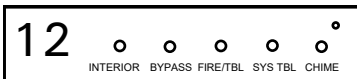

(Direct Entry)

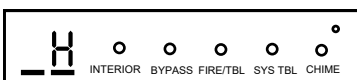
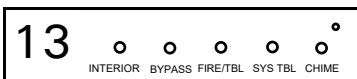

(Direct Entry)

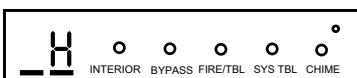
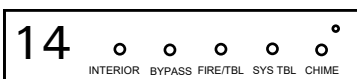

(Direct Entry)

Interior Zones *(Appears for New Panel Only)*

Directly enter the zone numbers which are to be used as Interior Zones. Valid entries are from 01 to 32. Directly enter each zone number, including leading zeros. Use number buttons [1] through [9P]. **NOTE:** Press the [0] button for a zero. Press [ENTER] to save and then repeat for any additional zone(s). Press the NEXT/YES button to proceed. **NOTE:** All Interior zones will also be automatically programmed as "Exit/Entry Follower" and "Power Up Delay" zones.

24 Hour Zones in Area 1 *(New Program Only)*

- Enter the zone numbers of zones to be used as 24 Hour zones.
- Valid entries are from 01 to 32. Directly enter each zone number, including leading zeros.
- Press [ENTER] to save and repeat for any additional zone(s); press the NEXT/YES button to proceed.

Chime Zones in Area 1 *(New Program Only)*

- Enter the zone numbers which are to be used as Chime Zones.
- Valid entries are from 01 to 32. Directly enter each zone number, including leading zeros.
- Press [ENTER] to save and then repeat for any additional zone(s), press the NEXT/YES button to proceed.

NOTE: A chime time of 2 seconds will be automatically programmed.

Chime 2 Zones in Area 1 *(New Program Only)*

- Enter the zone numbers which are to be used as Chime 2 Zones.
- Valid entries are from 01 to 32. Directly enter each zone number, including leading zeros.
- Press [ENTER] to save and then repeat for any additional zone(s), Press the NEXT/YES button to proceed.

NOTE: A chime time of 2 seconds will be automatically programmed. Chime 2 zones give a distinct pulsating tone when zone is faulted.

Exit/Entry2 Zones in Area 1 *(New Program Only)*

- Enter the zone numbers of zones to be used as Exit/Entry zones.
- Valid entries are from 01 to 32. Directly enter each zone number, including leading zeros.
- Press [ENTER] to save and repeat for any additional zone(s); press the NEXT/YES button to proceed.

NOTE: An Exit/Entry 2 Entry Time of 30 sec. will automatically be programmed.

50 mS Loop Response Zones *(New Program Only)*

- Enter the zone numbers of zones to be have a 50mS loop response.
- Valid entries are from 01 to 8. Directly enter each zone number, including leading zeros.
- Press [ENTER] to save and then repeat for any additional zone(s), press the NEXT/YES button to proceed. **(Note: 750mS is required for Loop Response time in UL or ETL installations).**

Note: Time can also be adjusted via address 2280.

Aux Output Activated on Alarm Zones *(New Program Only)*

- Enter the zone numbers of zones to activate the PGM2 Output upon alarm.
- Valid entries are from 01 to 32. Directly enter each zone number, including leading zeros.
- Press [ENTER] to save and then repeat for any additional zone(s), Press the NEXT/YES button to proceed.

NOTE: A PGM2 Output Timeout of 15 Minutes will automatically be programmed.



(Direct Entry)

Sensor Watch Zones (New Program Only)

- Enter the zone numbers of zones to be Sensor Watch zones.
- Valid entries are from 01 to 32. Directly enter each zone number, including leading zeros.
- Press  to save and then repeat for any additional zone(s), press the NEXT/YES button to proceed.

NOTE: A Sensor Watch Time of 24 hours will automatically be programmed.



(Direct Entry)

Keypad Sounder On Alarm Zones (New Program Only)

- Enter the zone numbers of all zones to activate the Keypad Sounder upon alarm.
- Valid entries are from 01 to 32. Directly enter each zone number, including leading zeros.
- Press  to save and then repeat for any additional zone(s), press the NEXT/YES button to proceed.

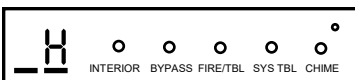

(Direct Entry)

Auto Bypass Re-entry Zones (New Program Only) (Not evaluated by UL or ETL)

- Enter the zone numbers of zones to be Auto Bypass Re-entry zones.
- Valid entries are from 01 to 32. Directly enter each zone number, including leading zeros.
- Press  to save and then repeat for any additional zone(s), press the NEXT/YES button to proceed.
- Auto Bypass Re-entry Zones allow the system to be armed with the zone faulted but come back into the system (armed) when the zone is subsequently closed.

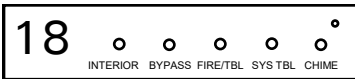

(Press YES or NO)

Enable No EOLR Zones (New Program Only)

- Press the NEXT/YES button to program all zones except 24 Hr & fire zones for No End Of Line Resistor. Press the PRIOR/NO button to continue. **NOTE:** Do not program this feature for UL or ETL Installations.

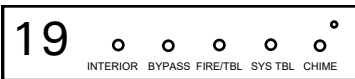

(Press YES or NO)

Enable Telco Line Fault Test?

- Press the NEXT/YES button to enable Telco Line Fault Test.
 - Press the PRIOR/NO button to continue.
- NOTE:** There is a preset 60 second Telco Line Fault Test Delay.

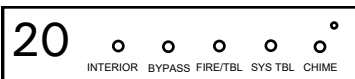

(Press YES or NO)

Enable Burg Output Chirp on KeyFob?

- Press the NEXT/YES button to enable Burg Output Chirp on KeyFob Arm / Disarm.
 - Press the PRIOR/NO button to continue.
- NOTE:** The Burg Output will chirp once on Keyfob Arm and twice on Keyfob Disarm.

(Press YES or NO)

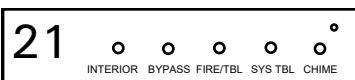

Enable SIA CP-01?

- Press the NEXT/YES button to enable.
 - Press the PRIOR/NO button to continue.
- The SIA CP-01 Features are designed to reduce the incidence of false alarms. **NOTE:** Do not enable unless reporting, otherwise system trouble *Fail to Communicate* may occur.

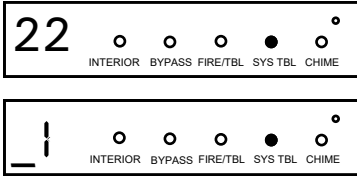

(Direct Entry)

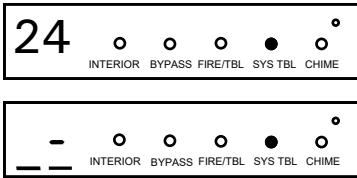

(Direct Entry)

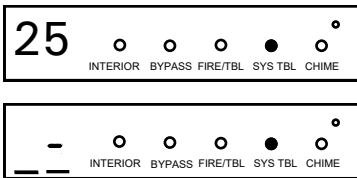

(Direct Entry)

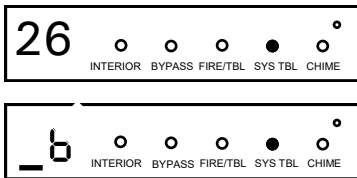

(Direct Entry)

Number of Keypads

Directly enter the total number of Keypads to be installed. Valid entries are from 01 to 07. Directly enter the number of keypads, including leading zeros. Use number buttons **1** through **9P**. **NOTE:** Press **0** for a zero. Press **SAVE** to save. Press the NEXT/YES button to proceed.

Central Station Receiver 1 Telephone Number

Using number buttons, enter telephone number of up to 16 digits including prefix letters, if necessary, for receiver 1. Use number buttons **1** through **9P** for digits 1-9; press ***0** for a zero and ***1** through ***5** for letters B-F, respectively. **NOTE:** Pre-Dial Delay = "D"; Dial-Tone Detection = "E". Pressing **0** will produce a blank space (*). Press **SAVE** to save. Press the NEXT/YES button to proceed. **NOTE:** Central Station Receiver 2 and 3 Telephone Numbers can only be entered in Direct Address Programming. See CS Receiver Options.

Central Station Receiver 1 Account Number

Enter an account number of up to four digits. Use number buttons **1** through **9P** for digits 1-9. **NOTE:** Press the **0** button for a zero and press the ***0** buttons for a blank space (*). Press **SAVE** to save. Press the NEXT/YES button to proceed. **NOTE:** Central Station Receiver 2 and 3 Account Numbers can only be entered in Direct Address Programming. See CS Reporting Options.

Central Station Receiver 1 Format

From the table below, enter the central station's receiver format. Use number buttons **1** through **9P**. **NOTE:** Press the **0** button for a zero and press ***0** for a blank space (*). Press ***1** through ***4** for letters B-E, respectively. Press **SAVE** to save. Press the NEXT/YES button to proceed.

DATA ENTRY	CS RECEIVER 1 FORMAT
blank(*)	Ademco Slow, Silent Knight Slow
1	Sescoa, Vertex, DCI, Franklin Fast
2	Radionics Fast
3	Silent Knight Fast
4	Radionics, DCI, Franklin Slow
5	Universal High Speed
8	Radionics BFSK

DATA ENTRY	CS RECEIVER 1 FORMAT
9	FBI 4/3/1
0	Radionics Modem 2
B	SIA
C	Ademco Point ID
D	Ademco Express
E	Pager

NOTE: Modem IIe is available only in Direct Address Programming. Central Station Receiver 2 and 3 Formats can only be entered in Direct Address Programming. See CS Receiver Options.

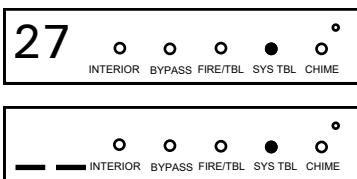

(Direct Entry)

Enter User Codes (Press the (MENU) button to set cursor)

Enter up to 32 User Codes with User Options for each code. Refer to the tables below for available data entries for User Options.

Press **MENU** once to set cursor to the User Number and enter the desired User Number. Press **MENU** once again to set the cursor to the User Code. Use the number buttons **1** through **9P** to enter a code from 3 to 6 digits. Enter up to 6 digits (4 digits are recommended) in the first six boxes from left to right for each user code. Valid entries are: 0-9. **Note:** Press **0** for a zero. No blank spaces in between; leave blank (*) any trailing boxes. If an "Ambush Prefix" (Address 0495) is entered, *do not* program the first two digits of ANY User Code as the same digits entered for the "Ambush Prefix".

If the programmed code is less than 6 digits, press **MENU** to set the cursor to USER OPTIONS. Refer to the tables on the next page for the available User Option data entries. **Note:** The factory default settings in version 30M+ firmware include:

- Users 1-15 are pre-assigned to Arm/Disarm Area 1; User 1 is assigned User Code "1 2 3".
- Users 20-29 are pre-assigned to Arm/Disarm Area 2

USER OPTIONS					
USER CODE (UP TO 6 DIGITS)			AREA 1 OPTIONS	AREA 2 OPTIONS	

USER AREA OPTIONS		
DATA ENTRIES		OPTION ENABLED
L	R	
blank(+)	blank(+)	Disabled
blank(+)	1	Arm/Disarm
blank(+)	2	Arm Only
blank(+)	3	Service
blank(+)	4	Access
blank(+)	5	Ambush
blank(+)	Add 8	* User Program
4	blank(+)	Bypass Enable

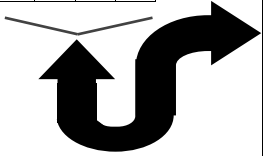

USER OPTIONS: Area 1 and 2 options for 32 Users:

Select the desired options from the table shown and enter in the remaining boxes for each user code.

Example: Program a code of "1234" for user 02, with Area 1 options of "Arm/Disarm" and "User Program":

With "27" displayed in keypad window, press **[MENU]**, **[0]** **[2]** (User 2), **[MENU]** **[1]** **[2]** **[3]** **[4]**, **[*]** **[0]** **[*]** **[0]** (User Code), **[0]** **[9]** (User Area 1 options), **[0]** **[0]** (User Area 2 Options), and **[ENTER]** (save).

Notes: (1) For **User Code**, press **[*]** **[0]** for Blank Space; (2) For **User Options**, press **[0]** for Blank Space.

CODE TYPE	EXPLANATION
Disabled	User Code not active.
Arm/Disarm	Allows User Code to arm/disarm.
Arm Only	Prevents User Code from disarming.
Service	A Service Code has restricted arm/disarm rights; if an area is armed with a Service Code, a "SERVICE ON" appears on the GEM-RP2ASe2 keypad and the area can be disarmed with any valid User Code, including a Service Code. If the area is armed with OTHER than a Service Code, it CANNOT be disarmed with a Service Code. This is typically used to allow tradesmen access to premises under control of the owner.
Access	This is normally used to activate a door strike. Also program "Access Control on PGM2 Output" (Address 0719) and "PGM2 Output Access Control Timeout" (Address 0711).
Ambush	There are two types of Ambush Codes: (1) A 2-digit code (prefix) that is entered immediately prior to (and as part of) the regular User Code and (2) A separate and unique User Code. Disarming with an Ambush Code will cause a silent report to be sent to a central station. Thus, should a user be forced to disarm, he can silently signal an emergency while appearing to be merely disarming the system.
* User Program	User Program Option is enabled for Keypad 1 only, wherever it is connected. To enable User Program Option for any user add 8 to the data entry Option (see example). Then, User Programming can be performed only at Keypad 1 by a user code with user program enabled.
Bypass Enable	Security Bypass-Bypass is enabled only with a security code.

Related User Options: "Enable Global Ambush Code" (Address 1422) & "Global Ambush Code" (Address 2045).

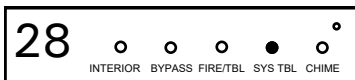

RF Transmitter Points (Press the **[MENU]** button to set cursor)

(For wireless systems only. Also see Quick Method, which follows).

For each transmitter (keyfob transmitters also), enter the zone number (01-32) to which the transmitter will be mapped, the 6-digit RF ID#: 1-digit checksum number printed on the transmitter and box, the point number (1 or 2); enter "9" for unsupervised (all points). **NOTE:** When programming the ID Code number, "A" = **[*]** **[0]**; "B" = **[*]** **[1]**; "C" = **[*]** **[2]**; "D" = **[*]** **[3]**; "E" = **[*]** **[4]**; "F" = **[*]** **[5]**. Press **[ON/OFF]** to save. Press NEXT (**[INTERIOR]**) to proceed.

Quick Enroll Method.

If a receiver is already installed in the panel, Napco transmitter wireless points can be programmed automatically ("enrolled") using the following procedure. **NOTE:** The transmitter point will be enrolled only if the signal strength is 3 or greater.

1. Enter the zone number to which the transmitter point will be mapped.
2. Press the **[BYPASS]** button to enter the Enroll Mode. The red and green LEDs on the keypad will flash and the window will display as shown at left.
3. Open the loop of the point that is to be programmed (GEM-TRANS2 or GEM-TRANS4 only).
4. Install the transmitter battery. The keypad will beep to indicate that the point has been successfully enrolled. Multi-point transmitters can be mapped to successive zones simultaneously (Example 1) or to selected zones point by point (Example 2).

Example 1. A 4-point transmitter has the RF ID number 410078:1. Map the first three points to Zones 11-13, respectively.

1. Enter the Enroll mode as described in step 2 above.
2. Enter Zone "11".

3. Open the loops of points 1, 2 and 3.
4. Install the transmitter battery. The keypad will beep 3 times to indicate that three points have been programmed.
 - Transmitter 410078:1, point 1 will be mapped to Zone 11.
 - Transmitter 410078:1, point 2 will be mapped to Zone 12.
 - Transmitter 410078:1, point 3 will be mapped to Zone 13.
 The keypad will now display Zone 13, the last zone enrolled.

Example 2. A 2-point transmitter has the RF ID number 287613:1. Map point 1 to Zone 6 and point 2 to Zone 9.

1. Enter the Enroll mode as described above.
2. Enter Zone "06".
3. Open point-1 loop.
4. Install the battery. The keypad will beep once to indicate that one point has been programmed. (Transmitter 287613:1, point 1 will be mapped to Zone 6).
5. Enter Zone "09".
6. Close point-1 loop and open point-2 loop.
7. Remove the transmitter battery, then re-install it. The keypad will beep once to indicate that one point has been programmed. (Transmitter 287613:1, point 2 is mapped to Zone 9).

KEYFOB ZONE ASSIGNMENT: Keyfobs can also be assigned to zones to allow multiple wireless panic buttons on one alarm system, each reporting to a central station, a pager or having a description on the keypad that describes the person holding the keyfob, the location where the person holding the keyfob is stationed, or the special purpose of the keyfob button being depressed. See the next page, *Keyfob Zone Assignment*.



Keyfob Transmitters (Press **MENU** to set cursor).

Keyfobs can be programmed as "Arm/Disarm" devices (refer to WI752).

For each Keyfob Transmitter, enter:

- The Keyfob Transmitter number (01–08).
- Area number to which transmitter is assigned (1 or 2); enter 0 to disable keyfob.
- The 6-digit RF ID # printed on the transmitter (enter all numbers and/or letters, including leading "0"s, if any).

- 1-digit checksum number printed on the transmitter (enter all numbers and/or letters, including leading "0"s, if any).
- Aux-1 Option (see keyfob aux 1 & aux 2 options).
- Aux-2 Option (see keyfob aux 1 & aux 2 options).

NOTE: Keyfobs 1-8 report openings and closings as Users 25-32.

Press **ENTER** to save. Press the NEXT/YES button to proceed.

DATA ENTRY	AUX 1/AUX 2 OPTIONS
0	None
1	Relay Group 1 Toggle
2	Relay Group 2 Toggle
9	Panic
A	Auxiliary
B	Instant
C	PGM2 Output Toggle
D	Access on PGM2 Output
E	Arm Stay
F	Interior Button

Note: If the Keyfob is converted for Two Button "Emergency Use" (by cutting an internal jumper), both top or bottom buttons must be depressed to activate an alarm. In this case, the Aux-1 and Aux-2 cannot be programmed.

Keyfob Transmitters as Zone Input Devices (refer to display above: press the PRIOR/NO button to go backwards).

Each of the 4 keyfob buttons can be assigned to a zone. For example, On button = point 1; Off button = point 2; A1 = point 3; A2 = point 4. Up to 32 keyfobs (using 1 button) or 16 keyfobs (using 2 buttons) or 8 keyfobs (using all 4 buttons) or any combination up to a maximum of 32 controlled zones can be assigned, providing multiple wireless panic buttons on a system, each reporting to the Central Station or a pager and/or annunciating on a keypad the keyfob zone number with description/location. *To assign a keyfob to a zone:* program the keyfob as you would a transmitter, entering the keyfob's ID code, check sum and point number at the appropriate zone. The "Quick Method" is not allowed. The zone may be hardwired to a sensor as well as assigned to a keyfob (either one will activate the zone alarm output). **NOTE:** If assigning a keyfob to a zone, the "ON/OFF" buttons on the keyfob will no longer arm/disarm the system. The keyfob is converted to a "panic only" device.

ZONE DESCRIPTIONS: GEM-K3DGTL cannot be used to enter Zone Descriptions. To enter Zone Descriptions, you must use the *GEM-K1CA Keypad* or the *Napco Quickloader Software*.

DATE ENTRY: GEM-K3DGTL cannot be used to enter the date. To enter Date, you must use the *GEM-K1CA Keypad (Version 5 or later)* or the *Napco Quickloader Software*.

TIME ENTRY: GEM-K3DGTL cannot be used to enter the time. To enter Time, you must use the *GEM-K1CA Keypad (Version 5 or later)* or the *Napco Quickloader Software*.

Daylight Saving Time

With the GEM-P1632 and GEM-P816 (version 10B or later): For automatic Daylight Saving Time adjustment for panels that are keypad programmed, use address 1193 for **Daylight Saving Time Enable**. The following step is not necessary for panels that are programmed with PCD-Windows Quickloader download software.

To Enable Daylight Saving Time with the Keypad:

1. Enter the panel's Dealer Security Code, then press **MENU** or **FUNCTION**.
 - Answer NO until "ACTIVATE PROGRAM Y/N" is displayed; then press YES.
 - Press **RESET** to enter Address Program Mode. Address "0000" displays.
2. Press **1** **1** **9P** **3** to access Address 1193.
3. To enable Daylight Saving Time, enter (• 1). To disable, enter (••).
4. Press **ON** or **OFF** to save.

Note: Unlike other address programming locations, address 1193 will always display "XX" even after programming and saving this feature.



Dealer Code

Directly enter the Dealer Code, including leading zeros. Use the **1** through **9P** buttons.

NOTE: Press **0** for a zero. Press **SAVE** to save.



(Direct Entry)

Re-enter the Dealer Code to verify the previous code. Press **SAVE** to save. Press the NEXT/YES button to proceed. **NOTE:** The Dealer Code can be two or more digits (up to 6 digits).

EXIT DEALER PROGRAM MODE: This completes the custom default program. Press **RESET** to enter the Direct Address Program Mode for further programming or press **RESET** once again to end all programming and resume normal keypad operation.

CLEAR PROGRAM: Should it be necessary to create a new custom default program, (a) from the Dealer Program Mode, press **RESET** to enter the Address Program Mode; (b) access Location 2285 (Clear Program) or 2286 (Cold Start); (c) press **SAVE** and then (d) press **RESET** to exit the Dealer Program Mode. A System Trouble Condition will occur. Enter your User Code and press **RESET** to silence the keypad.

KEYPAD ADDRESS PROGRAM MODE DISPLAYS

① = ADDRESS LOCATION ② = DATA ENTRY LOCATION (Left and Right Digits)

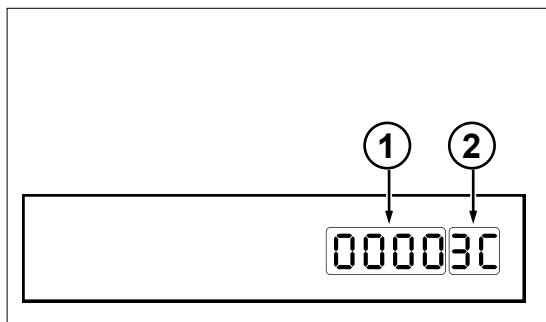

GEM-RP2ASe2 / GEM-K2AS Keypads

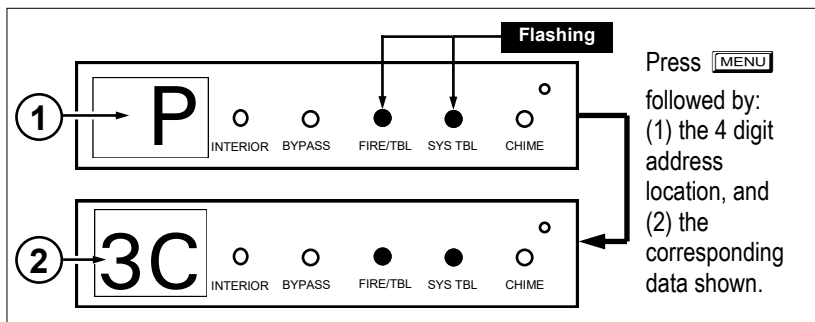

GEM-RP3DGTL / GEM-K3DGTL Keypads

Press **MENU** followed by:
(1) the 4 digit address location, and
(2) the corresponding data shown.

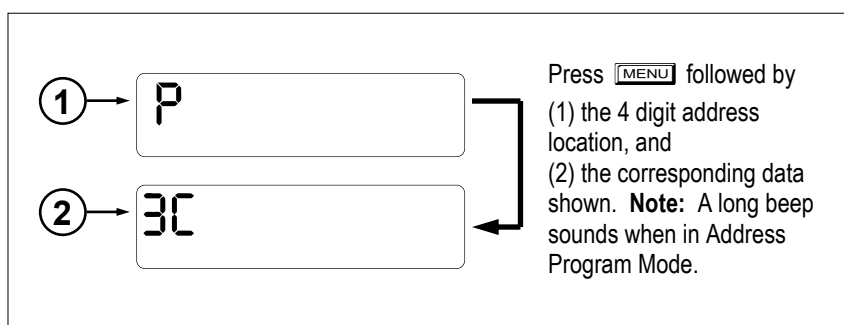

GEM-RP4RFC / GEM-K4RF Keypads

Press **MENU** followed by
(1) the 4 digit address location, and
(2) the corresponding data shown. **Note:** A long beep sounds when in Address Program Mode.

DIRECT ADDRESS PROGRAM MODE KEYPAD COMMANDS

A. GEM-K2AS (and GEM-RP2ASe2) Keypad

To access, press **RESET** in Dealer Program Mode

1. Toggle Cursor to 4-digit address field using the **MENU** button.
2. Enter address Number directly using number buttons (0-9).
3. Enter Data directly using number buttons.*
4. Press the **ARM/STAY** button to save.

To exit, press **RESET**.

NOTE: Press **0** button to clear character at cursor. Select NEXT/PRIOR Address. Press *** STAY** to jump to next programming block.

* Press *** 0** through *** 5** for 10-15, respectively.

B. GEM-K3DGTL/GEM-RP3DGTL Keypads

To access Direct Address Program Mode, press **RESET** in the Easy Menu Mode.

1. Press **MENU**.
 2. Enter the 4 digit Address location directly using number buttons (0-9).
 3. Enter the 2 digit data directly using number buttons (0-9).
 4. Press **SAVE** to save.
- To exit, press **RESET**.

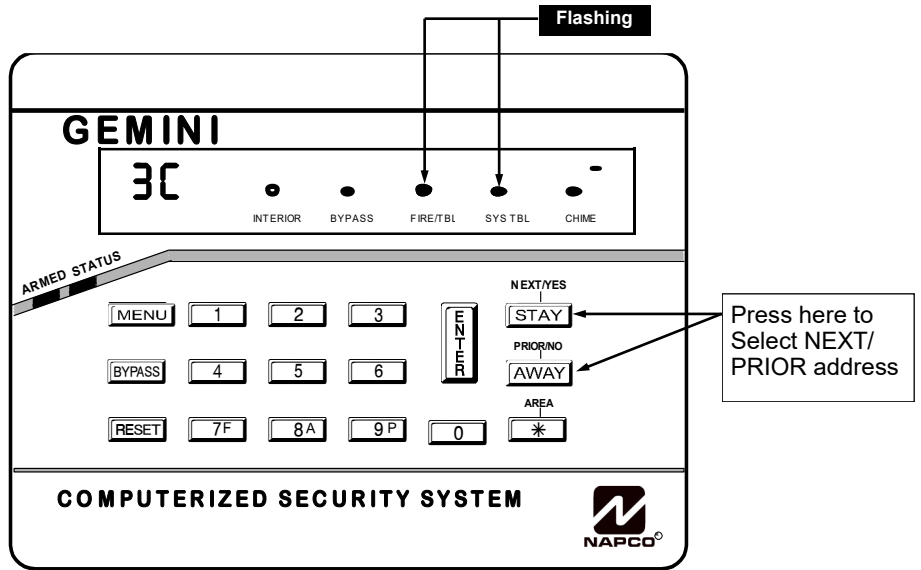

NOTE: "A" = * 0 ; "B" = * 1 ; "C" = * 2 ; "D" = * 3 ; "E" = * 4 ; "F" = * 5 . Press 0 for a zero or to clear.

Example: Direct Address Programming

Program Zones 6, 7 and 8 as Exit/Entry Follower Zones.

DETERMINE THE DATA ENTRIES

1. Referring to ZONE FEATURES in the Programming Worksheets that follow, Exit/Entry Follower for Zones 5 through 8 are located at address 0916, left digit. Circle the data values for Zones 5–8.
2. Add the data values for Zones 6, 7 and 8: $2+4+8=14$. From Tables 1 and 2, "14" (E) is entered as press * 4 . The right digit (for Zones 1 through 4, none of which are Exit/Entry Follower Zones) is entered as a blank (*).

ZONE OPTION	ZONES LEFT DATA VALUES SUM = 14 (CIRCLE)				ADDRESS 0916			ZONES RIGHT DATA VALUES SUM = 0 (CIRCLE)			
	ZN08	ZN07	ZN06	ZN05	L	ADDR	R	ZN04	ZN03	ZN02	ZN01
EXIT/ENTRY FOLLOWER	8	4	2	1	E	0916	BLANK (*)	8	4	2	1

ENTER DATA

PROGRAM THE DATA ENTRIES

1. Enter the panel's Dealer Security Code, then press **MENU**.
2. Answer NO (**INSTANT**) to all questions until "ACTIVATE PROGRAM Y/N" is displayed; then press the NEXT/YES button.
NOTE: If you pass "ACTIVATE PROGRAM", scroll backward using **BYPASS**.
3. Press **RESET** to enter the Address Program Mode. Address "0000" will display.
4. Press **0 9P 1 6** to access Address 0916. The data for both digits will display and the cursor will advance to the data field.
5. Press * 4 to enter an "E" in the left digit and press 0 to enter a blank (*) in the right digit.
6. Press **SAVE** to save. Address 0916 is now programmed with "E *".
7. Enter another 4-digit address to continue programming or press **RESET** to exit and resume normal keypad operation.

The displays shown on the previous pages will appear after a brief delay.

Use **MENU** to toggle the cursor between the 4-digit address field and the data entry locations.

Enter the address directly using the number buttons.

The contents of the address will be read automatically, along with the feature name and programming information. The cursor will advance to the data field. Enter the required data directly using the number buttons.

Press **SAVE** to save the contents of each address.

EXIT DIRECT ADDRESS PROGRAM MODE: When done, press **RESET** to exit and resume normal keypad operation.

CONVENTIONS USED IN THIS MANUAL

The Keypad Programming Worksheets in the back are provided as an address-programming reference to help the installer modify his custom default program or to make minor field alterations to an existing panel program. It is recommended that the panel be uploaded to NAPCO's PCD-Windows software following any keypad programming and that the PCD-Windows error-check feature be utilized to reduce the possibility of programming omissions or conflicts.

Note: Most of the addresses shown comprise two data entry locations, left and right digits. Program the left digits on the left data-display segment, and the right digit on the right segment. For those addresses having only one programmable nibble, program the right segment only; the left segment should display a blank (•).

Keep the Keypad Programming Worksheets on file for future reference.

General Programming Steps

- Contact the central station to ascertain receiver format, data format, event codes, subscriber numbers and telephone number(s).
- Select the desired features by circling  the respective "address" boxes. Refer to the Programming Options and Worksheets for guidance in selecting the "data" (1,2,4,8) to be entered into those boxes.
- Program the data entered in the boxes on the worksheets into the respective addresses. The display will show the entry numerically, but will display "0" for the number 10, and letters "B", "C", "D", "E", and "F" for the numbers 11 through 15, respectively. To program a 10, press *** 0**. To program 11 through 15, press *** 1** through *** 5**, respectively.

NOTE: See the Direct Address Programming Example on the previous page.

DATA ENTRY SELECTIONS (BINARY VALUE CIRCLED)				ENTRY TOTAL	PRESS 	KEYPAD DISPLAYS
8	4	2	1	blank	0	•
8	4	2	①	1	1	1
8	4	②	1	2	2	2
8	4	②	①	3	3	3
8	④	2	1	4	4	4
8	④	2	①	5	5	5
8	④	②	1	6	6	6
8	④	②	①	7	7F	7
⑧	4	2	1	8	8A	8
⑧	4	2	①	9	9P	9
⑧	4	②	1	10	* 0	0
⑧	4	②	①	11	* 1	B
⑧	④	2	1	12	* 2	C
⑧	④	2	①	13	* 3	D
⑧	④	②	1	14	* 4	E
⑧	④	②	①	15	* 5	F

Table 1 (above). Determining data entry for a location (each "nibble"). Numbers in parentheses indicate data for selected zones or features. (See Programming Worksheets that follow).

SYSTEM DELAYS & TIMEOUTS (ADDRESS 0000-0002, 1413, 1417, 2050 & 2055)

EXIT DELAY (sec.)	ADDRESS 0000	
	LEFT	RIGHT

[Default = 3 C]

ENTRY DELAY 1 (sec.)	ADDRESS 0001	
	LEFT	RIGHT

[Default = 1 E]

ENTRY DELAY 2 (sec.)	ADDRESS 0002	
	LEFT	RIGHT

[Default = 1 E]

PGM2 Output Access Cntrl Timeout (sec.)	ADDRESS 1413	
	LEFT	RIGHT

[Default = blank (*) blank (*)]

ABORT DELAY (sec.)	ADDRESS 1417	
	LEFT	RIGHT

[Default = 1 E]

DATA ENTRIES		DELAY/TIMEOUT
LEFT	RIGHT	
blank (*)	blank (*)	0 sec.
blank (*)	F	15 sec.
1	E	30 sec.
2	D	45 sec.
3	C	60 sec.
5	0	90 sec.
7	8	120 sec.
F	F	255 min.

1. Select delay/timeout (0-255 sec.) from the table shown.
 2. Enter in corresponding address locations above (left and right digits).
 3. For a desired delay/timeout not listed do the following:
 A. Choose a desired delay/timeout, ex: 20 sec.
 B. Divide it by 16
 4. Press to save.

16	20)	Quotient	→	Left Digit
	-16))	
	4))	Remainder
))	→
))	Right Digit

EXIT/ENTRY DELAYS: Apply only to zones programmed with the following options "Exit/Entry 1, Exit/Entry 2, Exit/Entry Follower". For UL or ETL Installations, the maximum exit delay is 60 seconds and the maximum entry delay is 45 seconds.
NOTE: Sensor Watch Time Options are similar to above table, except in hours.

Sensor Watch Time (Hrs.)	ADDRESS 2050	
	LEFT	RIGHT

[Default = 24 HRS = 1 8]

Report Cancel Window (min.)	ADDRESS 2055	
	LEFT	RIGHT

[Default = zero minutes = blank (*) blank (*)]

PROGRAMMING TIMEOUTS: Either use the tables provided or calculate your own timeout using the steps indicated. **WARNING:** Timers have uncertainty of +/-1sec, so a "time" of 1 second may actually timeout IMMEDIATELY.

SYSTEM DELAYS & TIMEOUTS (ADDRESS 1418 & 1419)

CHIME TIME (%sec.)	ADDRESS 1418	
	LEFT	RIGHT

[Default = 2 sec. = blank (*) 8]

AC Fail Report Delay (min.)	ADDRESS 1419	
	LEFT	RIGHT

[Default = 60 mins. = 3 C]

DEFAULTS: The defaults shown on this page and on the following pages are automatically set after exiting the Easy Menu Driven Mode.

CHIME TIMEOUT OPTIONS		
DATA ENTRIES		TIMEOUT
LEFT	RIGHT	
blank (*)	blank (*)	(0) ¼sec. = 0 sec.
blank (*)	2	(2) ¼sec. = ½ sec.
blank (*)	3	(3) ¼sec. = ¾ sec.
blank (*)	4	(4) ¼sec. = 1 sec.
blank (*)	5	(5) ¼sec. = 1.25 sec.
blank (*)	6	(6) ¼sec. = 1.5 sec.
blank (*)	7	(7) ¼sec. = 1.75 sec.
blank (*)	8	(8) ¼sec. = 2 sec.
F	F	(255) ¼sec. = 63.25 sec.

AC FAIL REPORT DELAY OPTIONS		
DATA ENTRIES		TIMEOUT
LEFT	RIGHT	
blank (*)	blank (*)	blank (*)
blank (*)	1	1
blank (*)	2	2
blank (*)	3	3
blank (*)	4	4
blank (*)	5	5
blank (*)	6	6
blank (*)	7	7
F	F	255 min. = 4 Hr., 30 min.

Program Option	ADDRESS LOC.	
	LEFT	RIGHT

ENTER DATA

PROGRAMMING STEPS:

1. Lookup desired Programming Option by Address Location (highlighted in black).
2. Select the programming option data entry from the tables shown.
3. Enter the selected data entry in the boxes shown.
4. For more information on a programming option refer to the Glossary at the end of this manual.

1. Select delay/timeout from the table shown.
 2. Enter in corresponding address locations above (left and right digits).
 3. For a desired delay/timeout not listed do the following:
 A. Choose a desired delay/timeout, ex: 20
 B. Divide it by 16
 4. Press to save.

16	20)	Quotient	→	Left Digit
	-16))	
	4))	Remainder
))	→
))	Right Digit

SYSTEM OUTPUT TIMEOUTS (ADDRESS 1412 & 1414-1416)

PGM2 Output Timeout (min.)	ADDRESS 1412	
	LEFT	RIGHT
	blank (*)	blank (*)

[Default = blank (*) blank (*)]

Alarm Output Timeout (min.)	ADDRESS 1414	
	LEFT	RIGHT
	blank (*)	F

[Default = 15 mins. = (blank) F]

Pulse Alarm Output Timeout (min.)	ADDRESS 1415	
	LEFT	RIGHT
	blank (*)	F

[Default = 15 mins. = (blank) F]

PGM1 Output Timeout (min.)	ADDRESS 1416	
	LEFT	RIGHT
	blank (*)	blank (*)

[Default = blank (*) blank (*)]

DATA ENTRIES		DELAY/ TIMEOUT
LEFT	RIGHT	
blank (*)	blank (*)	0 min.
blank (*)	1	1 min.
blank (*)	2	2 min.
blank (*)	3	3 min.
blank (*)	4	4 min.
blank (*)	5	5 min.
blank (*)	6	6 min.
1	blank (*)	16 min.
↓	↓	↓
F	F	255 min.

1. Select delay/timeout (0-255 min.) from the table shown.
2. Enter in corresponding address locations above (left and right digits).
3. For a desired delay/timeout not listed do the following:
 - A. Choose a desired delay/timeout, ex: 20 min.
 - B. Divide it by 16

4. Press to save.

$$\begin{array}{r} 16 \overline{)20} \\ -16 \\ \hline 4 \end{array}$$

① Quotient → Left Digit

② Remainder → Right Digit

OUTPUT TIMEOUTS: If a timeout of "0 min." is selected, then the output will remain active (ON) until the system is reset or disarmed. For UL or ETL Residential Installations, the minimum timeout is 5 minutes. Not UL or ETL Listed for Commercial Installations.

DOWNLOAD/CALLBACK OPTIONS (ADDRESS 2059 & 0526-0545)

No. Rings Before Pickup	ADDRESS 2059	
	LEFT	RIGHT
	blank (*)	blank (*)

[Default = blank (*) blank (*)]

NUMBER OF RINGS BEFORE PICKUP: Enter the number of rings before automatic pickup by the control panel when downloading from a computer (see installation instructions WI808 for more information).

1. Enter in right digit only (left digit is not used).
2. Valid entries are: 3-9, 0 = 10, B = 11, C = 12, D = 13, E = 14, F = 15

NOTE: Default is 15 Rings. Dark shaded data shows option not available.

3. Press to save.

CALLBACK Telephone Number (Digits 1-20)	ADDRESS 0526-0545 (RIGHT DIGITS 1-20)																			
	0526	0527	0528	0529	0530	0531	0532	0533	0534	0535	0536	0537	0538	0539	0540	0541	0542	0543	0544	0545
	R	R	R	R	R	R	R	R	R	R	R	R	R	R	R	R	R	R	R	R

[Default = blank (*) for all digits 1-20]

CALLBACK TELEPHONE NUMBER: Enter telephone number to be used when downloading from a computer (see installation instructions WI808 for more information).

1. Enter in right digit only (left digit is not used).
2. Enter up to 20 digits from left to right. **NOTE:** Leave trailing boxes blank (*). For a zero, press .
3. Valid entries are: 1-9, B = , C = , D = 3 sec. pause, E = Wait for dial tone, F = ignore location.
4. Press to save.

PAGER FORMAT OPTIONS (ADDRESS 0546 & 0547)

Leading Digits for Pager Format (1st Digit)	ADDRESS 0546	
	LEFT	RIGHT
	blank (*)	blank (*)

LEADING DIGITS FOR PAGER FORMAT: In Pager Format reporting, the message typically begins with "00". However, for some pager services, this will cause the Pager's Voice Mail feature to activate. This option allows you to program these digits to any number desired. A typical Pager report is "003 22 1234", where 3 is the Event, 22 is the zone, and 1234 is the Subscriber ID number. For example, if the Leading Digits are programmed as "98", the Pager report will now appear as "983 22 1234". **NOTE:** See CS Receiver Options to select Pager Format.

Leading Digits for Pager Format (2nd Digit)	ADDRESS 0547	
	LEFT	RIGHT
	blank (*)	blank (*)

[Default = blank (*) blank (*)]

1. Enter in 1st and 2nd Leading Digits in right digit only (left digit is not used) as shown.
2. Valid entries are: 0-9.
3. Press to save.

SYSTEM OPTIONS (ADDRESS 0836-0871 & 2045)

SYSTEM RESPONSE ACTIVATED BY GLOBAL EVENT/TROUBLE	GLOBAL SYSTEM EVENT/TROUBLE LEFT DATA VALUES (CIRCLE)				ADDRESS 0836-0843			GLOBAL SYSTEM EVENT/TROUBLE RIGHT DATA VALUES (CIRCLE)			
	Bell Superv.	EZM TAMPER	AC FAIL	LOW BATTERY	LEFT	ADDR	RIGHT	MEMORY FAILURE	RF RCVR. TROUBLE	TELCO FAILURE	TEST TIMER
Alarm Output	8	4	2	1		0836		8	4	2	1
Pulsed Alarm Output	8	4	2	1		0837		8	4	2	1
PGM1 Output	8	4	2	1		0838		8	4	2	1
PGM2 Output	8	4	2	1		0839		8	4	2	1
Report Event Telco 1	8	4	2	1		0840		8	4	2	1
Report Restore Telco 1	8	4	2	1		0841		8	4	2	1
Report Event Telco 3	8	4	2	1		0842		8	4	2	1
Report Restore Telco 3	8	4	2	1		0843		8	4	2	1

[Default = blank (*) blank (*) from address 0836-0843] **Note:** If *Test Timer* is enabled (above), *Digital Dialer Test* is also enabled.

SYSTEM RESPONSE ACTIVATED BY AREA 1 EVENT/TROUBLE	AREA 1 SYSTEM EVENT/TROUBLE LEFT DATA VALUES (CIRCLE)				ADDRESS 0856-0863			AREA 1 SYSTEM EVENT/TROUBLE RIGHT DATA VALUES (CIRCLE)			
	Keyfob Low Batt.	FAIL TO CLOSE	FAIL TO OPEN	KEYPAD TAMPER	LEFT	ADDR	RIGHT	KEYPAD AUX. [‡]	KEYPAD FIRE	KEYPAD PANIC	AMBUSH
Pulsed Alarm Output	8	4	2	1		0856		8	4	2	1
Alarm Output	8	4	2	1		0857		8	4	2	1
PGM1 Output	8	4	2	1		0858		8	4	2	1
PGM2 Output	8	4	2	1		0860		8	4	2	1
Report Event Telco 1	8	4	2	1		0861		8	4	2	1
Report Event Telco 3	8	4	2	1		0863		8	4	2	1

[Default = blank (*) blank (*) from address 0856-0863]

[‡]NOTE: Keypad Aux. is not to be selected for UL or ETL Installations.

SYSTEM RESPONSE ACTIVATED BY AREA 2 EVENT/TROUBLE	AREA 2 SYSTEM EVENT/TROUBLE LEFT DATA VALUES (CIRCLE)				ADDRESS 0864-0871			AREA 2 SYSTEM EVENT/TROUBLE RIGHT DATA VALUES (CIRCLE)			
	Keyfob Low Batt.	FAIL TO CLOSE	FAIL TO OPEN	KEYPAD TAMPER	LEFT	ADDR	RIGHT	KEYPAD AUX. [‡]	KEYPAD FIRE	KEYPAD PANIC	AMBUSH
Pulsed Alarm Output	8	4	2	1		0864		8	4	2	1
Alarm Output	8	4	2	1		0865		8	4	2	1
PGM1 Output	8	4	2	1		0866		8	4	2	1
PGM2 Output	8	4	2	1		0868		8	4	2	1
Report Event Telco 1	8	4	2	1		0869		8	4	2	1
Report Event Telco 3	8	4	2	1		0871		8	4	2	1

[Default = blank (*) blank (*) from address 0864-0871]

[‡]NOTE: Keypad Aux. is not to be selected for UL or ETL Installations.

1. Select the desired option by circling the data values for each digit (left and right).
2. Add the data values (ex: F=15=(1+2+4+8) from the selected options. See page 23).
3. Enter in address location (left and right digits). **NOTE:** Dark shaded data value box shows option not available.
4. Press to save.

Global Ambush Code	ADDRESS 2045	
	LEFT	RIGHT

[Default = blank (*) blank (*)]

GLOBAL AMBUSH CODE: It is the 2-digits entered immediately prior to the regular disarm code. If "Enable Global Ambush Code" (Address 1422) is selected and Address 2045 is left blank (*), then the 2-digit Global Ambush Code is "99". If "Enable Global Ambush Code" is selected and Address 2045 is **not** left blank (*), then the 2-digit Global Ambush Code is the two digits entered in address 2045.

Enter in address location (both left and right digits) ; valid entries are 1-9.

Press to save.

^{ss}GEM-P1632 control panels with firmware V10 or higher were modified to comply with the SIA CP-01 standard: When **Automatic Interior Bypass** is programmed, the feature **Interior Normally Bypassed** is no longer required. All Interior (Stay) Bypass zones will be properly bypassed if no activity occurs on an Exit/Entry zone during arming, and Automatic Interior Bypass only is programmed.

SYSTEM OPTIONS (ADDRESS 1420-1424)

SYSTEM OPTIONS	LEFT DATA VALUES (CIRCLE)	ADDRESS 1420		RIGHT DATA VALUES (CIRCLE)	SYSTEM OPTIONS
RESERVED	1	LEFT DIGIT (SUM OF DATA VALUES)	RIGHT DIGIT (SUM OF DATA VALUES)	1	Opening Report Only after Alarm Report
Enable AutoArm if not closed at end of Window	2			2	Closing Report Only on Conditional Close
Enable Keypad Time/Date Display	4			4	Incl. Sel./Grp. Bypass in Cond. Close /Status
Disable Zone Fault Scrolling	8			8	Status Report
		[Default = blank (•) blank (•)]			

SYSTEM OPTIONS	LEFT DATA VALUES (CIRCLE)	ADDRESS 1421		RIGHT DATA VALUES (CIRCLE)	SYSTEM OPTIONS
Access Control on PGM2 Output	1	LEFT DIGIT (SUM OF DATA VALUES)	RIGHT DIGIT (SUM OF DATA VALUES)	1	Auto Bell Test on Arming
Maintained Keyswitch Arming	2			2	Auto Reset after Burglary Output Timeout
RESERVED	4			4	Suppress Bypass Reminder when Armed
Disable Keypad Instant Mode	8			8	Enable Local Alarm on First Zone AND Trip
		[Default = blank (•) blank (•)]			

SYSTEM OPTIONS	LEFT DATA VALUES (CIRCLE)	ADDRESS 1422		RIGHT DATA VALUES (CIRCLE)	SYSTEM OPTIONS
Disable Keypad Function Mode Download	1	LEFT DIGIT (SUM OF DATA VALUES)	RIGHT DIGIT (SUM OF DATA VALUES)	1	Interior Normally Bypassed ^{§§}
Disable Callback Download	2			2	Enable Global Ambush Code ***
Chirp Output on Keyfob Arm/Disarm	4			4	Reset Day Zone with Arm/Disarm Only
Change Pulse Output to Temporal Output [§]	8			8	Enable Residential Fire
		[Default = blank (•) blank (•)]			

SYSTEM OPTIONS	LEFT DATA VALUES (CIRCLE)	ADDRESS 1423		RIGHT DATA VALUES (CIRCLE)	SYSTEM OPTIONS
Line-Fault Test only when Armed**	1	LEFT DIGIT (SUM OF DATA VALUES)	RIGHT DIGIT (SUM OF DATA VALUES)	1	Enable Zone Doubling (Zones 9-16)
Enable Line-Fault Test**	2			2	Wireless Trouble Activates Telco 1
Inhibit System Trouble Audible at Keypad [‡]	4			4	Wireless Trouble Activates Telco 3
Select Alarm Output for Keypad Chirp	8			8	Enable Alarm Output on Telco Fail only when Armed
		[Default = blank (•) blank (•)]			

For Address 1423: Default depends on Easy Menu Question "EZ ZONE DOUBLING? Y/N".
If yes, then [Default = •(blank) 1].
If no, then [Default = •(blank) •(blank)].

SYSTEM OPTIONS	LEFT DATA VALUES (CIRCLE)	ADDRESS 1424		RIGHT DATA VALUES (CIRCLE)	SYSTEM OPTIONS
Don't Clear PGM2 Output with Disarm	1	LEFT DIGIT (SUM OF DATA VALUES)	RIGHT DIGIT (SUM OF DATA VALUES)	1	Automatic Interior Bypass/Easy Exit ^{§§}
Disable 2nd Call Ans. Machine Override	2			2	Veri-phone Zones Trip PGM2 Output
RESERVED	4			4	Veri-phone Audio Priority Over Alarms
Disable Code Required for EZ Bypass	8			8	Resound on Wireless Smoke Low Battery
		[Default = blank (8) blank (•)]			

1. Select the desired option by circling the data values for each digit (left and right).
2. Add the data values (ex: F=15=(1+2+4+8)) from the selected options. See page 23).
3. Enter in address location (left and right digits). **NOTE:** Dark shaded data value box shows option not available.
4. Press to save.

*Address 1423: Default depends on Easy Menu Question "EZ ZONE DOUBLING? Y/N". If yes, then [Default = 1]. If no, then [Default = blank (•)].

**To select "Line-Fault Test only when Armed", you must also select "Enable Line-Fault Test" at address 1423.

***If "Enable Global Ambush Code" in Address 1422 is selected, then program the 2-digit "Global Ambush Code" in Address 2045. If Address 2045 is left blank (•), then, the 2-digit "Global Ambush Code" will be "99".

[‡]Not for UL or ETL Installations.

[§]This feature must be programmed in Fire Alarm applications.

^{§§}See note on page 27.

SYSTEM OPTIONS (ADDRESS 2051-2054)

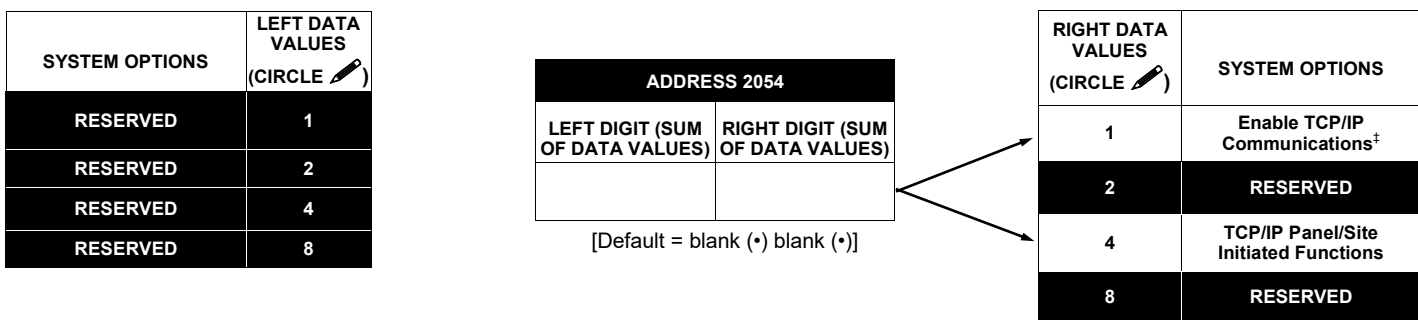
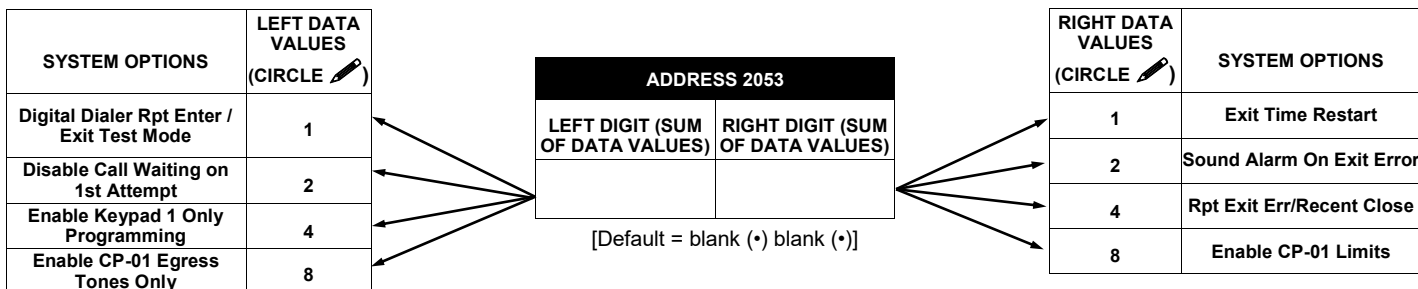
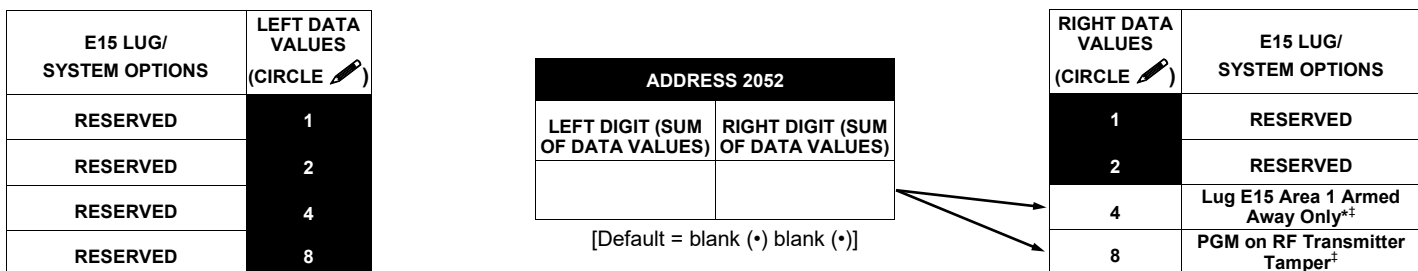
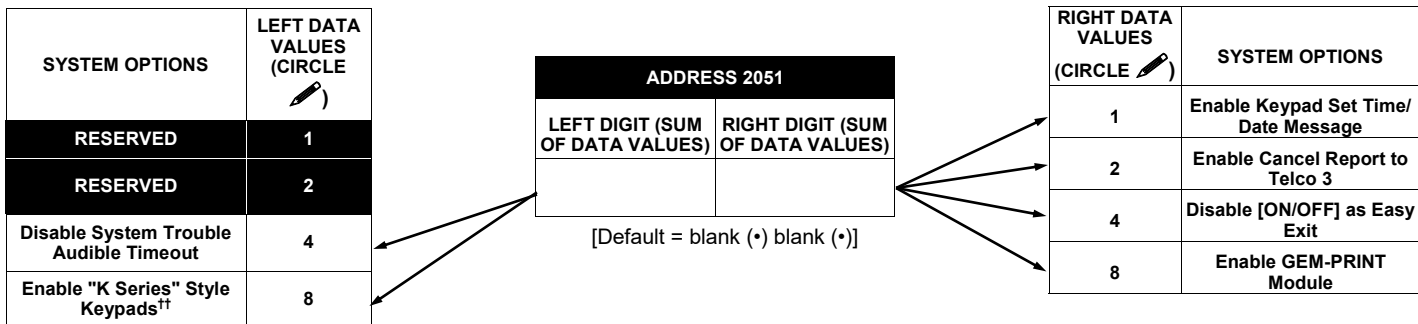

1. Select the desired option by circling the data values for each digit (left and right).
2. Add the data values (ex: F=15=(1+2+4+8) from the selected options. See page 23).
3. Enter in address location (left and right digits). **NOTE:** Dark shaded data value box shows option not available.
4. Press to save.

* (Address 2052) If this feature is not selected, the E15 Lug will, by default, activate when the system is armed (all areas).

^{††} This option is for reference only and cannot be changed.

[‡] Not for UL or ETL Installations.

CS RECEIVER OPTIONS (ADDRESS 0460-0525)

CS Receiver 1 Format	ADDRESS 0460	
	LEFT	RIGHT
	blank (*)	

CS Receiver 2 Format	ADDRESS 0482	
	LEFT	RIGHT
	blank (*)	

CS Receiver 3 Format	ADDRESS 0504	
	LEFT	RIGHT
	blank (*)	

DATA ENTRY	CS RECEIVER 1 FORMAT
blank (*)	Ademco Slow, Silent Knight Slow
2	Radionics Fast
3	Silent Knight Fast
4	Radionics, DCI, Franklin Slow
5	Universal High Speed
B	SIA
C	Ademco Point ID
E	Pager *

Default for CS Receiver 1 Format depends on Easy Menu Question "RCVR FORMAT". [Default = *(blank) * (blank)] for CS Receivers 2 and 3 Formats.

CS RECEIVER FORMATS: Up to 3 CS Formats may be programmed.

1. Select the desired CS Receiver Format from the table shown.
2. Enter in the corresponding right digit address location (left digit is not used) for each CS Receiver. **NOTE:** Dark shaded data value box shows option not available.
3. Press to save.

*See Pager Format Options to program Leading Digits for Pager Format.

<table border="1" style="width: 100%; border-collapse: collapse;"> <tr> <th style="width: 70%;">CS RECEIVER TELCO 1 OPTIONS</th> <th style="width: 30%;">LEFT DATA VALUES (CIRCLE)</th> </tr> <tr> <td>Sum Check</td> <td style="text-align: center;">1</td> </tr> <tr> <td>3/1 with Extended Restores</td> <td style="text-align: center;">2</td> </tr> <tr> <td>Enable TCP/IP AES RPT</td> <td style="text-align: center;">4</td> </tr> <tr> <td style="background-color: black; color: white;">RESERVED</td> <td style="background-color: black; color: white;">8</td> </tr> </table>	CS RECEIVER TELCO 1 OPTIONS	LEFT DATA VALUES (CIRCLE)	Sum Check	1	3/1 with Extended Restores	2	Enable TCP/IP AES RPT	4	RESERVED	8	<table border="1" style="width: 100%; border-collapse: collapse;"> <tr> <th colspan="2" style="background-color: black; color: white;">ADDRESS 0461</th> </tr> <tr> <td style="width: 50%;">LEFT DIGIT (SUM OF DATA VALUES)</td> <td style="width: 50%;">RIGHT DIGIT (SUM OF DATA VALUES)</td> </tr> <tr> <td style="height: 30px;"> </td> <td style="height: 30px;"> </td> </tr> </table> <p>[Default = blank (*) blank (*)]</p>	ADDRESS 0461		LEFT DIGIT (SUM OF DATA VALUES)	RIGHT DIGIT (SUM OF DATA VALUES)			<table border="1" style="width: 100%; border-collapse: collapse;"> <tr> <th style="width: 30%;">RIGHT DATA VALUES (CIRCLE)</th> <th>CS RECEIVER TELCO 1 OPTIONS</th> </tr> <tr> <td style="text-align: center;">1</td> <td>1400Hz Handshake/Kissoff *</td> </tr> <tr> <td style="text-align: center;">2</td> <td>2300Hz Handshake/Kissoff *</td> </tr> <tr> <td style="text-align: center;">4</td> <td>Enable Zone Number on Pulse Alarm</td> </tr> <tr> <td style="text-align: center;">8</td> <td>Single Digit Only</td> </tr> </table>	RIGHT DATA VALUES (CIRCLE)	CS RECEIVER TELCO 1 OPTIONS	1	1400Hz Handshake/Kissoff *	2	2300Hz Handshake/Kissoff *	4	Enable Zone Number on Pulse Alarm	8	Single Digit Only
CS RECEIVER TELCO 1 OPTIONS	LEFT DATA VALUES (CIRCLE)																											
Sum Check	1																											
3/1 with Extended Restores	2																											
Enable TCP/IP AES RPT	4																											
RESERVED	8																											
ADDRESS 0461																												
LEFT DIGIT (SUM OF DATA VALUES)	RIGHT DIGIT (SUM OF DATA VALUES)																											
RIGHT DATA VALUES (CIRCLE)	CS RECEIVER TELCO 1 OPTIONS																											
1	1400Hz Handshake/Kissoff *																											
2	2300Hz Handshake/Kissoff *																											
4	Enable Zone Number on Pulse Alarm																											
8	Single Digit Only																											
<table border="1" style="width: 100%; border-collapse: collapse;"> <tr> <th style="width: 70%;">CS RECEIVER TELCO 2 OPTIONS</th> <th style="width: 30%;">LEFT DATA VALUES (CIRCLE)</th> </tr> <tr> <td>Sum Check</td> <td style="text-align: center;">1</td> </tr> <tr> <td>3/1 with Extended Restores</td> <td style="text-align: center;">2</td> </tr> <tr> <td>Enable TCP/IP AES RPT</td> <td style="text-align: center;">4</td> </tr> <tr> <td style="background-color: black; color: white;">RESERVED</td> <td style="background-color: black; color: white;">8</td> </tr> </table>	CS RECEIVER TELCO 2 OPTIONS	LEFT DATA VALUES (CIRCLE)	Sum Check	1	3/1 with Extended Restores	2	Enable TCP/IP AES RPT	4	RESERVED	8	<table border="1" style="width: 100%; border-collapse: collapse;"> <tr> <th colspan="2" style="background-color: black; color: white;">ADDRESS 0483</th> </tr> <tr> <td style="width: 50%;">LEFT DIGIT (SUM OF DATA VALUES)</td> <td style="width: 50%;">RIGHT DIGIT (SUM OF DATA VALUES)</td> </tr> <tr> <td style="height: 30px;"> </td> <td style="height: 30px;"> </td> </tr> </table> <p>[Default = blank (*) blank (*)]</p>	ADDRESS 0483		LEFT DIGIT (SUM OF DATA VALUES)	RIGHT DIGIT (SUM OF DATA VALUES)			<table border="1" style="width: 100%; border-collapse: collapse;"> <tr> <th style="width: 30%;">RIGHT DATA VALUES (CIRCLE)</th> <th>CS RECEIVER TELCO 2 OPTIONS</th> </tr> <tr> <td style="text-align: center;">1</td> <td>1400Hz Handshake/Kissoff *</td> </tr> <tr> <td style="text-align: center;">2</td> <td>2300Hz Handshake/Kissoff *</td> </tr> <tr> <td style="text-align: center;">4</td> <td>Enable Zone Number on Pulse Alarm</td> </tr> <tr> <td style="text-align: center;">8</td> <td>Single Digit Only</td> </tr> </table>	RIGHT DATA VALUES (CIRCLE)	CS RECEIVER TELCO 2 OPTIONS	1	1400Hz Handshake/Kissoff *	2	2300Hz Handshake/Kissoff *	4	Enable Zone Number on Pulse Alarm	8	Single Digit Only
CS RECEIVER TELCO 2 OPTIONS	LEFT DATA VALUES (CIRCLE)																											
Sum Check	1																											
3/1 with Extended Restores	2																											
Enable TCP/IP AES RPT	4																											
RESERVED	8																											
ADDRESS 0483																												
LEFT DIGIT (SUM OF DATA VALUES)	RIGHT DIGIT (SUM OF DATA VALUES)																											
RIGHT DATA VALUES (CIRCLE)	CS RECEIVER TELCO 2 OPTIONS																											
1	1400Hz Handshake/Kissoff *																											
2	2300Hz Handshake/Kissoff *																											
4	Enable Zone Number on Pulse Alarm																											
8	Single Digit Only																											
<table border="1" style="width: 100%; border-collapse: collapse;"> <tr> <th style="width: 70%;">CS RECEIVER TELCO 3 OPTIONS</th> <th style="width: 30%;">LEFT DATA VALUES (CIRCLE)</th> </tr> <tr> <td>Sum Check</td> <td style="text-align: center;">1</td> </tr> <tr> <td>3/1 with Extended Restores</td> <td style="text-align: center;">2</td> </tr> <tr> <td>Enable TCP/IP AES RPT</td> <td style="text-align: center;">4</td> </tr> <tr> <td style="background-color: black; color: white;">RESERVED</td> <td style="background-color: black; color: white;">8</td> </tr> </table>	CS RECEIVER TELCO 3 OPTIONS	LEFT DATA VALUES (CIRCLE)	Sum Check	1	3/1 with Extended Restores	2	Enable TCP/IP AES RPT	4	RESERVED	8	<table border="1" style="width: 100%; border-collapse: collapse;"> <tr> <th colspan="2" style="background-color: black; color: white;">ADDRESS 0505</th> </tr> <tr> <td style="width: 50%;">LEFT DIGIT (SUM OF DATA VALUES)</td> <td style="width: 50%;">RIGHT DIGIT (SUM OF DATA VALUES)</td> </tr> <tr> <td style="height: 30px;"> </td> <td style="height: 30px;"> </td> </tr> </table> <p>[Default = blank (*) blank (*)]</p>	ADDRESS 0505		LEFT DIGIT (SUM OF DATA VALUES)	RIGHT DIGIT (SUM OF DATA VALUES)			<table border="1" style="width: 100%; border-collapse: collapse;"> <tr> <th style="width: 30%;">RIGHT DATA VALUES (CIRCLE)</th> <th>CS RECEIVER TELCO 3 OPTIONS</th> </tr> <tr> <td style="text-align: center;">1</td> <td>1400Hz Handshake/Kissoff *</td> </tr> <tr> <td style="text-align: center;">2</td> <td>2300Hz Handshake/Kissoff *</td> </tr> <tr> <td style="text-align: center;">4</td> <td>Enable Zone Number on Pulse Alarm</td> </tr> <tr> <td style="text-align: center;">8</td> <td>Single Digit Only</td> </tr> </table>	RIGHT DATA VALUES (CIRCLE)	CS RECEIVER TELCO 3 OPTIONS	1	1400Hz Handshake/Kissoff *	2	2300Hz Handshake/Kissoff *	4	Enable Zone Number on Pulse Alarm	8	Single Digit Only
CS RECEIVER TELCO 3 OPTIONS	LEFT DATA VALUES (CIRCLE)																											
Sum Check	1																											
3/1 with Extended Restores	2																											
Enable TCP/IP AES RPT	4																											
RESERVED	8																											
ADDRESS 0505																												
LEFT DIGIT (SUM OF DATA VALUES)	RIGHT DIGIT (SUM OF DATA VALUES)																											
RIGHT DATA VALUES (CIRCLE)	CS RECEIVER TELCO 3 OPTIONS																											
1	1400Hz Handshake/Kissoff *																											
2	2300Hz Handshake/Kissoff *																											
4	Enable Zone Number on Pulse Alarm																											
8	Single Digit Only																											

CS RECEIVER OPTIONS: Select options for any of the three CS Receivers.

1. Select the desired option by circling the data values for each digit (left and right).
 2. Add the data values (ex: F=15=(1+2+4+8)) from the selected options. See page 23).
 3. Enter in address location (left and right digits).
- NOTE:** Dark shaded data value box shows option not available. Press to save.

NOTE: * If both are selected, 1400Hz has priority over 2300Hz.

CS Receiver 1 Telephone Number (Digits 1-20)	ADDRESS 0462-0481 (RIGHT DIGITS 1-20)																			
	0462	0463	0464	0465	0466	0467	0468	0469	0470	0471	0472	0473	0474	0475	0476	0477	0478	0479	0480	0481
	R	R	R	R	R	R	R	R	R	R	R	R	R	R	R	R	R	R	R	R
CS Receiver 2 Telephone Number (Digits 1-20)	ADDRESS 0484-0503 (RIGHT DIGITS 1-20)																			
	0484	0485	0486	0487	0488	0489	0490	0491	0492	0493	0494	0495	0496	0497	0498	0499	0500	0501	0502	0503
	R	R	R	R	R	R	R	R	R	R	R	R	R	R	R	R	R	R	R	R
CS Receiver 3 Telephone Number (Digits 1-20)	ADDRESS 0506-0525 (RIGHT DIGITS 1-20)																			
	0506	0507	0508	0509	0510	0511	0512	0513	0514	0515	0516	0517	0518	0519	0520	0521	0522	0523	0524	0525
	R	R	R	R	R	R	R	R	R	R	R	R	R	R	R	R	R	R	R	R

Default for CS Receiver 1 Telephone Number depends on Easy Menu Question "CENTRAL PHONE #".

[Default = blank (*)] across digits 1-20 for CS Receiver Telephone Numbers 2 and 3.

CS RECEIVER TELEPHONE NUMBERS: Enter telephone numbers for any of the three CS Receivers (Telco 1, 2 & 3).

1. Enter in right digit only (left digit is not used).
2. Enter up to 20 digits from left to right. **NOTE:** Leave trailing boxes blank (*). For a zero, press .
3. Valid entries are: 1-9, B = , C = , D = 3 sec. pause, E = Wait for dial tone, F = ignore location. Press to save.

CS SUBSCRIBER ID OPTIONS (ADDRESS 0560-0667)

CS Telco 1 Sub- scriber Opening/ Closing ID Number (Area 1)	ADDRESS 0560-0563 (RIGHT DIGITS 1-4)			
	0560	0561	0562	0563

CS Telco 1 Sub- scriber Opening/ Closing ID Number (Area 2)	ADDRESS 0564-0567 (RIGHT DIGITS 1-4)			
	0564	0565	0566	0567

CS Telco 1 Sub- scriber Event ID Number (Area 1)	ADDRESS 0576-0579 (RIGHT DIGITS 1-4)			
	0576	0577	0578	0579

CS Telco 1 Sub- scriber Event ID Number (Area 2)	ADDRESS 0580-0583 (RIGHT DIGITS 1-4)			
	0580	0581	0582	0583

CS Telco 1 Sub- scriber Event ID Number (System)	ADDRESS 0592-0595 (RIGHT DIGITS 1-4)			
	0592	0593	0594	0595

CS Telco 2 Sub- scriber Opening/ Closing ID Number (Area 1)	ADDRESS 0596-0599 (RIGHT DIGITS 1-4)			
	0596	0597	0598	0599

CS Telco 2 Sub- scriber Opening/ Closing ID Number (Area 2)	ADDRESS 0600-0603 (RIGHT DIGITS 1-4)			
	0600	0601	0602	0603

CS Telco 2 Sub- scriber Event ID Number (Area 1)	ADDRESS 0612-0615 (RIGHT DIGITS 1-4)			
	0612	0613	0614	0615

CS Telco 2 Sub- scriber Event ID Number (Area 2)	ADDRESS 0616-0619 (RIGHT DIGITS 1-4)			
	0616	0617	0618	0619

CS Telco 2 Sub- scriber Event ID Number (System)	ADDRESS 0628-0631 (RIGHT DIGITS 1-4)			
	0628	0629	0630	0631

CS Telco 3 Sub- scriber Opening/ Closing ID Number (Area 1)	ADDRESS 0632-0635 (RIGHT DIGITS 1-4)			
	0632	0633	0634	0635

CS Telco 3 Sub- scriber Opening/ Closing ID Number (Area 2)	ADDRESS 0636-0639 (RIGHT DIGITS 1-4)			
	0636	0637	0638	0639

CS Telco 3 Sub- scriber Event ID Number (Area 1)	ADDRESS 0648-0651 (RIGHT DIGITS 1-4)			
	0648	0649	0650	0651

CS Telco 3 Sub- scriber Event ID Number (Area 2)	ADDRESS 0652-0655 (RIGHT DIGITS 1-4)			
	0652	0653	0654	0655

CS Telco 3 Sub- scriber Event ID Number (System)	ADDRESS 0664-0667 (RIGHT DIGITS 1-4)			
	0664	0665	0666	0667

Default for CS Telco 1 Subscriber Event ID Number (Area 1) depends on Easy Menu Question "ACCOUNT #". [Default = blank (*) blank (*) blank (*) blank (*)] for all other ID Numbers.

CS TELCO SUBSCRIBER ID NUMBERS: Enter the Subscriber Opening/Closing and Event ID Numbers for any of the 3 CS Receivers.

1. Enter in corresponding right digit address location (*left digit is not used*).
2. Enter 3 or 4 digits (depending on the CS receiver format) for each subscriber number from left to right. **NOTE:** Leave trailing boxes blank (*). For a zero, press . Valid entries are: 1-9, 0 and B-F. **NOTE:** A is not permitted. Press [Enter] to save.

CS SYSTEM REPORTING OPTIONS (ADDRESS 0670-0705)

CS SYSTEM REPORTING CODES	ADDRESS 0670-0682	
	ADDR	
Alarm Restore	blank (*)	0670
Trouble	blank (*)	0671
Trouble Restore	blank (*)	0672
Xmitter Low Battery	blank (*)	0673
Xmitter Supervision	blank (*)	0674
Xmitter Tamper	blank (*)	0675
RESERVED	blank (*)	0676
Opening	blank (*)	0677
Closing	blank (*)	0678
Opening after Alarm	blank (*)	0679
Conditional Close	blank (*)	0680
Cancel	blank (*)	0681
Test Timer		0682

CS SYSTEM REPORTING CODES	ADDRESS 0683-0708	
	ADDR	
Telco Fail	0683	
RF Rec. Trouble	0684	
Memory Fail	0685	
Low Battery	0686	
Panel AC Fail	0687	
EZM Tamper	0688	
Alarm Output Superv.	0689	
Ambush	0698	
Panic	0699	
Fire	0700	
Auxiliary [‡]	0701	
Tamper	0702	
Fail to Open	0703	
Fail to Close	0704	
Keyfob Low Battery	0705	

CS SYSTEM REPORTING CODES:

1. Enter in corresponding address location (left and right digits).
NOTE: Left digit is the first digit and right digit is the second digit in a two digit CS receiver format.
2. Valid entries are: 1-9, 0 and B-F.
NOTE: A is not permitted.
3. To disable a code leave boxes blank (*).
NOTE: Dark shaded data value box shows option not available.
4. Press  to save.

[Default = blank (*) blank (*) from address 0670-0682]
[Default = blank (*) blank (*) from address 0683-0705]

[‡]**NOTE:** Keypad Aux. is not to be selected for UL or ETL Installations.

CS AREA & SYSTEM REPORTING OPTIONS (ADDRESS 0785, 0786 & 0788)

DISABLE OPENING REPORTS	
ADDRESS 0785	
LEFT DIGIT	RIGHT DIGIT (SUM OF DATA VALUES)
blank (*)	

[Default = blank (*) blank (*)]

RIGHT DATA VALUES (CIRCLE )	AREA
1	AREA 1
2	RESERVED
4	RESERVED
8	RESERVED

DISABLE CLOSING REPORTS	
ADDRESS 0786	
LEFT DIGIT	RIGHT DIGIT (SUM OF DATA VALUES)
blank (*)	

[Default = blank (*) blank (*)]

RIGHT DATA VALUES (CIRCLE )	AREA
1	AREA 1
2	RESERVED
4	RESERVED
8	RESERVED

CS SYSTEM REPORT OPTIONS	LEFT DATA VALUES (CIRCLE )
Cancel Next Test Timer on any Report	1
Disable Wait for Silence (Pager Format)	2
Disable Wait for Handshake on Transmit	4
Disable Auto Dial Tone Detect	8

ADDRESS 0788	
LEFT DIGIT (SUM OF DATA VALUES)	RIGHT DIGIT (SUM OF DATA VALUES)

[Default = blank (*) blank (2)]

RIGHT DATA VALUES (CIRCLE )	CS SYSTEM REPORT OPTIONS
1	Backup Report on Telco 1 & 2
2	Touch-tone Dialing Only*
4	Touch-tone Dialing w/Rotary Backup*
8	RESERVED

CS AREA & SYSTEM REPORTING OPTIONS:

1. Select the desired option by circling  the data values for each digit (left and right).
2. Add the data values (ex: F=15=(1+2+4+8) from the selected options. See page 23).
3. Enter in address location (left and right digits).

NOTE: Dark shaded data value box shows option not available. Press  to save.

* **NOTE:** If neither Touch-tone Dialing nor Touch-tone w/Rotary Backup is selected, then system defaults automatically to Rotary Dialing. Leave blank (*) to select Rotary Dialing.

CS ZONE REPORTING OPTIONS (ADDRESS 0720-0751)

ADDRESS 0720-0727							
CONTROL PANEL ZONES REPORT CODE							
ZONE 1	ZONE 2	ZONE 3	ZONE 4	ZONE 5	ZONE 6	ZONE 7	ZONE 8
0720	0721	0722	0723	0724	0725	0726	0727
L R	L R	L R	L R	L R	L R	L R	L R

ADDRESS 0728-0731			
ZONES REPORT CODE			
ZONE 9	ZONE 10	ZONE 11	ZONE 12
0728	0729	0730	0731
L R	L R	L R	L R

ADDRESS 0732-0735			
ZONES REPORT CODE			
ZONE 13	ZONE 14	ZONE 15	ZONE 16
0732	0733	0734	0735
L R	L R	L R	L R

ADDRESS 0736-0739			
ZONES REPORT CODE			
ZONE 17	ZONE 18	ZONE 19	ZONE 20
0736	0737	0738	0739
L R	L R	L R	L R

ADDRESS 0740-0743			
ZONES REPORT CODE			
ZONE 21	ZONE 22	ZONE 23	ZONE 24
0740	0741	0742	0743
L R	L R	L R	L R

ADDRESS 0744-0747			
ZONES REPORT CODE			
ZONE 25	ZONE 26	ZONE 27	ZONE 28
0744	0745	0746	0747
L R	L R	L R	L R

ADDRESS 0748-0751			
ZONES REPORT CODE			
ZONE 29	ZONE 30	ZONE 31	ZONE 32
0748	0749	0750	0751
L R	L R	L R	L R

Default for Group Zone Report Codes depends on Easy Menu Question "RCVR. FORMAT".

ZONE REPORT CODE OPTIONS	
DATA ENTRIES	
LEFT	RIGHT

NOTE: If "Zone Doubling" (Address 1423) is **not** enabled, then Zones 1-8 are included in the control panel and Zones 9-32 are EZM Zones. If "Zone Doubling" is enabled, then Zones 1-16 are included in the control panel and Zones 17-32 are EZM Zones. See Address 1455-1460 to enable "EZM Group Options".

DATA ENTRIES LEFT	MODEM CODE
1	Fire
2	Panic
3	Burglary
4	Hold up
7	Gas Alarm
8	Heat Alarm
0	Auxiliary Alarm
B	24 Hour Auxiliary

PULSE EVENT CODE will be the first digit of the 2 digit reporting code. The second digit will be the second digit of the reporting zone. For example, for zone 9 (address 0728), if the right digit is "3", then the reporting code is "39". For example, for zone 15 (address 0734), if the right digit is "4", then the reporting code is "45".

MODEM CODES determine the zone types reported for the following formats: SIA and ADEMCO Point ID.

1. Select the desired Modem Code for each zone from the table shown.

2. Press to save.

CS USER REPORTING OPTIONS (ADDRESS 0800-0813)

User Opening Telco 1	LEFT DATA VALUE				ADDRESS 0800		RIGHT DATA VALUES				LEFT DATA VALUE				ADDRESS 0801		RIGHT DATA VALUES			
	User 8	User 7	User 6	User 5	LEFT	RIGHT	User 4	User 3	User 2	User 1	User 16	User 15	User 14	User 13	LEFT	RIGHT	User 12	User 11	User 10	User 9
	8	4	2	1			8	4	2	1	8	4	2	1			8	4	2	1

User Opening Telco 1	LEFT DATA VALUE				ADDRESS 0802		RIGHT DATA VALUES				LEFT DATA VALUES				ADDRESS 0803		RIGHT DATA VALUES			
	User 24	User 23	User 22	User 21	LEFT	RIGHT	User 20	User 19	User 18	User 17	User 32	User 31	User 30	User 29	LEFT	RIGHT	User 28	User 27	User 26	User 25
	8	4	2	1			8	4	2	1	8	4	2	1			8	4	2	1

User Opening Telco 1	ADDRESS 0804		RIGHT DATA VALUES			
	LEFT	RIGHT	User 36	User 35	User 34	User 33
			8		2	1

User 33 = Auto Arming/Disarming
 User 34 = Quickloader Remote Arming/Disarming
 User 35 = Easy Arming (Opening not applicable)
 User 36 = Keyswitch Arming

NOTE: These opening events will report as the user number shown. Also, Keyfobs 1-8 (see Easy Menu Program Driven Mode) will report as Users 25-32, respectively.

User Opening Telco 1	LEFT DATA VALUE				ADDRESS 0809		RIGHT DATA VALUES				LEFT DATA VALUE				ADDRESS 0810		RIGHT DATA VALUES			
	User 8	User 7	User 6	User 5	LEFT	RIGHT	User 4	User 3	User 2	User 1	User 16	User 15	User 14	User 13	LEFT	RIGHT	User 12	User 11	User 10	User 9
	8	4	2	1			8	4	2	1	8	4	2	1			8	4	2	1

User Opening Telco 1	LEFT DATA VALUE				ADDRESS 0811		RIGHT DATA VALUES				LEFT DATA VALUES				ADDRESS 0812		RIGHT DATA VALUES			
	User 24	User 23	User 22	User 21	LEFT	RIGHT	User 20	User 19	User 18	User 17	User 32	User 31	User 30	User 29	LEFT	RIGHT	User 28	User 27	User 26	User 25
	8	4	2	1			8	4	2	1	8	4	2	1			8	4	2	1

User Opening Telco 1	ADDRESS 0813		RIGHT DATA VALUES			
	LEFT	RIGHT	User 36	User 35	User 34	User 33
			8		2	1

User 33 = Auto Arming/Disarming
 User 34 = Quickloader Remote Arming/Disarming
 User 35 = Easy Arming (Opening not applicable)
 User 36 = Keyswitch Arming

NOTE: These opening events will report as the user number shown. Also, Keyfobs 1-8 (see Easy Menu Program Driven Mode) will report as Users 25-32, respectively.

CS USER REPORTING OPTIONS: [Default = blank (*) blank (*) from address 0800-0813]

1. Select the desired option by circling the data values for each digit (left and right).
2. Add the data values (ex: F=15=(1+2+4+8) from the selected options. See page 23).
3. Enter in address location (left and right digits). **NOTE:** Dark shaded data value box shows option not available.
4. Press to save.

CS USER REPORTING OPTIONS (ADDRESS 0818-0831)

User Opening Telco 3	LEFT DATA VALUE				ADDRESS 0818		RIGHT DATA VALUES				LEFT DATA VALUE				ADDRESS 0819		RIGHT DATA VALUES			
	User 8	User 7	User 6	User 5	LEFT	RIGHT	User 4	User 3	User 2	User 1	User 16	User 15	User 14	User 13	LEFT	RIGHT	User 12	User 11	User 10	User 9
	8	4	2	1			8	4	2	1	8	4	2	1			8	4	2	1

User Opening Telco 3	LEFT DATA VALUE				ADDRESS 0820		RIGHT DATA VALUES				LEFT DATA VALUES				ADDRESS 0821		RIGHT DATA VALUES			
	User 24	User 23	User 22	User 21	LEFT	RIGHT	User 20	User 19	User 18	User 17	User 32	User 31	User 30	User 29	LEFT	RIGHT	User 28	User 27	User 26	User 25
	8	4	2	1			8	4	2	1	8	4	2	1			8	4	2	1

User Opening Telco 3	ADDRESS 0822		RIGHT DATA VALUES			
	LEFT	RIGHT	User 36	User 35	User 34	User 33
			8		2	1

User 33 = Auto Arming/Disarming
 User 34 = Quickloader Remote Arming/Disarming
 User 35 = Easy Arming (Opening not applicable)
 User 36 = Keypress Arming

NOTE: These opening events will report as the user number shown. Also, Keyfobs 1-8 (see Easy Menu Program Driven Mode) will report as Users 25-32, respectively.

User Opening Telco 3	LEFT DATA VALUE				ADDRESS 0827		RIGHT DATA VALUES				LEFT DATA VALUE				ADDRESS 0828		RIGHT DATA VALUES			
	User 8	User 7	User 6	User 5	LEFT	RIGHT	User 4	User 3	User 2	User 1	User 16	User 15	User 14	User 13	LEFT	RIGHT	User 12	User 11	User 10	User 9
	8	4	2	1			8	4	2	1	8	4	2	1			8	4	2	1

User Opening Telco 3	LEFT DATA VALUE				ADDRESS 0829		RIGHT DATA VALUES				LEFT DATA VALUES				ADDRESS 0830		RIGHT DATA VALUES			
	User 24	User 23	User 22	User 21	LEFT	RIGHT	User 20	User 19	User 18	User 17	User 32	User 31	User 30	User 29	LEFT	RIGHT	User 28	User 27	User 26	User 25
	8	4	2	1			8	4	2	1	8	4	2	1			8	4	2	1

User Opening Telco 3	ADDRESS 0831		RIGHT DATA VALUES			
	LEFT	RIGHT	User 36	User 35	User 34	User 33
			8		2	1

User 33 = Auto Arming/Disarming
 User 34 = Quickloader Remote Arming/Disarming
 User 35 = Easy Arming (Opening not applicable)
 User 36 = Keypress Arming

NOTE: These opening events will report as the user number shown. Also, Keyfobs 1-8 (see Easy Menu Program Driven Mode) will report as Users 25-32, respectively.

CS USER REPORTING OPTIONS: [Default = blank (•) blank (•) from address 0818-0831]

1. Select the desired option by circling the data values for each digit (left and right).
2. Add the data values (ex: F=15=(1+2+4+8) from the selected options. See page 23).
3. Enter in address location (left and right digits). **NOTE:** Dark shaded data value box shows option not available.
4. Press to save.

EZM GROUP OPTIONS (ADDRESS 1455-1460)

EZM Group 1	EZM Group 2	EZM Group 3	EZM Group 4	EZM Group 5	EZM Group 6
ADDRESS 1455	ADDRESS 1456	ADDRESS 1457	ADDRESS 1458	ADDRESS 1459	ADDRESS 1460
LEFT RIGHT	LEFT RIGHT	LEFT RIGHT	LEFT RIGHT	LEFT RIGHT	LEFT RIGHT
blank (*)	blank (*)	blank (*)	blank (*)	blank (*)	blank (*)

Default depends on Easy Menu Question "## OF ZNS IN AREA 1 ENTER ## ZONES" and "EZ ZONE DOUBLING? Y/N". For example, if 32 Zones are used and Zone Doubling is **not** enabled, then all 6 Groups will be automatically enabled. If 32 Zones are used and Zone Doubling is enabled, then only Groups 1-4 will be automatically enabled.

NOTE: If "Zone Doubling" (Address 1423, option 1) is **not** enabled, then Zones 1-8 are included in the control panel and Zones 9-32 (Groups 1-6) are EZM Zones. If "Zone Doubling" is enabled, then Zones 1-16 are included in the control panel and Zones 17-32 (Groups 1-4) are EZM Zones (and Groups 5 and 6 must not be used).

EZM TYPE		EZM GROUP	ZONES COVERED	
DATA ENTRIES	OPTION		NORMAL	DOUBLED
blank (*)	Not used (No EZM present)	1	9-12	17-20
		2	13-16	21-24
		3	17-20	25-28
		4	21-24	29-32
1	4-Zone EZM	5	25-28	
		6	29-32	

EZM GROUP OPTIONS: Up to 6 Groups of 4 Zones each may be programmed depending on the number of Zones used and which EZM modules are connected. Each Group represents 4 Zones.

1. Select EZM type from the table shown.
2. Enter either blank (*) or "1" in corresponding address locations above.

NOTE: Dark shaded data value box shows option not available.

3. Press to save.

AREA ARMING OPTIONS (ADDRESS 1469-1470)

Priority Area 2 must be armed before arming Area 1 allowed	ADDRESS 1469	
	LEFT	RIGHT

[Default = blank (*) blank (*)]

Priority Area 1 must be armed before arming Area 2 allowed	ADDRESS 1470	
	LEFT	RIGHT

[Default = blank (*) blank (*)]

PRIORITY ARMING		
Priority Area 2 must be armed before arming Area 1 allowed		
DATA ENTRIES		OPTION
LEFT	RIGHT	
blank (*)	blank (*)	Not Used
blank (*)	2	Enabled

PRIORITY ARMING		
Priority Area 1 must be armed before arming Area 2 allowed		
DATA ENTRIES		OPTION
LEFT	RIGHT	
blank (*)	blank (*)	Not Used
blank (*)	1	Enabled

PRIORITY AREA ARMING:

Prevents area arming if the associated "Priority Area" has not yet been armed. In other words, the "Priority Area" must be armed before the "Arming Area" can be armed.

1. Select option from the table shown.
2. Enter in corresponding left and right digit address locations.

NOTE: Dark shaded data value box shows option not available.

3. Press to save.

AREA BELL CONTROL OPTIONS (ADDRESS 1473, 1474)

Area 1: Burglary Output Turns Off upon Disarm

RESERVED	LEFT DATA VALUES (CIRCLE)	Burglary Output Turns Off upon Disarm ADDRESS 1473	RIGHT DATA VALUES (CIRCLE)	Disarming Area 1
RESERVED	1	LEFT DIGIT (SUM OF DATA VALUES)	RIGHT DIGIT (SUM OF DATA VALUES)	1 Area 1 Burg Output Silenced
RESERVED	2	•	(1)	2 Area 2 Burg Output Silenced
RESERVED	4	[Default = blank (*) one (1)]		RESERVED
RESERVED	8			RESERVED

Area 2: Burglary Output Turns Off upon Disarm

RESERVED	LEFT DATA VALUES (CIRCLE)	Burglary Output Turns Off upon Disarm ADDRESS 1474	RIGHT DATA VALUES (CIRCLE)	Disarming Area 2
RESERVED	1	LEFT DIGIT (SUM OF DATA VALUES)	RIGHT DIGIT (SUM OF DATA VALUES)	1 Area 1 Burg Output Silenced
RESERVED	2	•	(1)	2 Area 2 Burg Output Silenced
RESERVED	4	[Default = blank (*) one (1)]		RESERVED
RESERVED	8			RESERVED

OUTPUT TURNS OFF UPON DISARM:

Select options for the Output. By default, the ability to turn off an output upon disarm is not allowed. For example, the ability to silence an Area 1 or Area 2 output via an Area 1 keypad is not enabled by default. To enable selected area output control, enter the number (1 or 2) accordingly. For example, if you wish to grant an Area 1 keypad the ability to turn off an Area 2 PGM2 output, enter "2" in Address 1485.

1. Select the desired option by circling the data values for right digit only (left is not used).
2. Add the data values (ex: F=15=(1+2+4+8)) from the selected options. See page 23).
3. Enter in right digit address location. **NOTE:** Dark shaded data value box shows option not available.
4. Press to save.

AREA BELL CONTROL OPTIONS (ADDRESS 1477, 1478)

Area 1: Pulsed Burg Output Turns Off upon Disarm

RESERVED	LEFT DATA VALUES (CIRCLE)
RESERVED	1
RESERVED	2
RESERVED	4
RESERVED	8

Pulsed Burg Output Turns Off upon Disarm	
ADDRESS 1477	
LEFT DIGIT (SUM OF DATA VALUES)	RIGHT DIGIT (SUM OF DATA VALUES)
•	(1)

[Default = blank (•) one (1)]

RIGHT DATA VALUES (CIRCLE)	Disarming Area 1
1	Area 1 Pulsed Burg Output Silenced
2	Area 2 Pulsed Burg Output Silenced
4	RESERVED
8	RESERVED

Area 2: Pulsed Burg Output Turns Off upon Disarm

RESERVED	LEFT DATA VALUES (CIRCLE)
RESERVED	1
RESERVED	2
RESERVED	4
RESERVED	8

Pulsed Burg Output Turns Off upon Disarm	
ADDRESS 1478	
LEFT DIGIT (SUM OF DATA VALUES)	RIGHT DIGIT (SUM OF DATA VALUES)
•	(1)

[Default = blank (•) one (1)]

RIGHT DATA VALUES (CIRCLE)	Disarming Area 2
1	Area 1 Pulsed Burg Output Silenced
2	Area 2 Pulsed Burg Output Silenced
4	RESERVED
8	RESERVED

OUTPUT TURNS OFF UPON DISARM:

Select options for the Output. By default, the ability to turn off an output upon disarm is not allowed. For example, the ability to silence an Area 1 or Area 2 output via an Area 1 keypad is not enabled by default. To enable selected area output control, enter the number (1 or 2) accordingly. For example, if you wish to grant an Area 1 keypad the ability to turn off an Area 2 PGM2 output, enter "2" in Address 1485.

1. Select the desired option by circling the data values for right digit only (left is not used).
2. Add the data values (ex: $F=15=(1+2+4+8)$) from the selected options. See page 23).
3. Enter in right digit address location. **NOTE:** Dark shaded data value box shows option not available.
4. Press to save.

AREA BELL CONTROL OPTIONS (ADDRESS 1481, 1482)

Area 1: PGM1 Output Turns Off upon Disarm

RESERVED	LEFT DATA VALUES (CIRCLE)	PGM1 Output Turns Off upon Disarm ADDRESS 1481	RIGHT DATA VALUES (CIRCLE)	Disarming Area 1
RESERVED	1	LEFT DIGIT (SUM OF DATA VALUES)	RIGHT DIGIT (SUM OF DATA VALUES)	1 Area 1 PGM1 Output Silenced
RESERVED	2	●	(1)	2 Area 2 PGM1 Output Silenced
RESERVED	4	[Default = blank (*) one (1)]		RESERVED
RESERVED	8			RESERVED

Area 2: PGM1 Output Turns Off upon Disarm

RESERVED	LEFT DATA VALUES (CIRCLE)	PGM1 Output Turns Off upon Disarm ADDRESS 1482	RIGHT DATA VALUES (CIRCLE)	Disarming Area 2
RESERVED	1	LEFT DIGIT (SUM OF DATA VALUES)	RIGHT DIGIT (SUM OF DATA VALUES)	1 Area 1 PGM1 Output Silenced
RESERVED	2	●	(1)	2 Area 2 PGM1 Output Silenced
RESERVED	4	[Default = blank (*) one (1)]		RESERVED
RESERVED	8			RESERVED

OUTPUT TURNS OFF UPON DISARM:

Select options for the Output. By default, the ability to turn off an output upon disarm is not allowed. For example, the ability to silence an Area 1 or Area 2 output via an Area 1 keypad is not enabled by default. To enable selected area output control, enter the number (1 or 2) accordingly. For example, if you wish to grant an Area 1 keypad the ability to turn off an Area 2 PGM2 output, enter "2" in Address 1485.

1. Select the desired option by circling the data values for right digit only (left is not used).
2. Add the data values (ex: F=15=(1+2+4+8)) from the selected options. See page 23).
3. Enter in right digit address location. **NOTE:** Dark shaded data value box shows option not available.
4. Press to save.

AREA BELL CONTROL OPTIONS (ADDRESS 1485, 1486)

Area 1: PGM2 Output Turns Off upon Disarm

RESERVED	LEFT DATA VALUES (CIRCLE)	PGM2 Output Turns Off upon Disarm ADDRESS 1485	RIGHT DATA VALUES (CIRCLE)	Disarming Area 1
RESERVED	1	LEFT DIGIT (SUM OF DATA VALUES)	RIGHT DIGIT (SUM OF DATA VALUES)	1
RESERVED	2	●	(1)	2
RESERVED	4	[Default = blank (*) one (1)]		4
RESERVED	8			8
				Area 1 PGM2 Burg Output Silenced
				Area 2 PGM2 Burg Output Silenced
				RESERVED
				RESERVED

Area 2: PGM2 Output Turns Off upon Disarm

RESERVED	LEFT DATA VALUES (CIRCLE)	PGM2 Output Turns Off upon Disarm ADDRESS 1486	RIGHT DATA VALUES (CIRCLE)	Disarming Area 2
RESERVED	1	LEFT DIGIT (SUM OF DATA VALUES)	RIGHT DIGIT (SUM OF DATA VALUES)	1
RESERVED	2	●	(1)	2
RESERVED	4	[Default = blank (*) one (1)]		4
RESERVED	8			8
				Area 1 PGM2 Burg Output Silenced
				Area 2 PGM2 Burg Output Silenced
				RESERVED
				RESERVED

OUTPUT TURNS OFF UPON DISARM:

Select options for the Output. By default, the ability to turn off an output upon disarm is not allowed. For example, the ability to silence an Area 1 or Area 2 output via an Area 1 keypad is not enabled by default. To enable selected area output control, enter the number (1 or 2) accordingly. For example, if you wish to grant an Area 1 keypad the ability to turn off an Area 2 PGM2 output, enter "2" in Address 1485.

1. Select the desired option by circling the data values for right digit only (left is not used).
2. Add the data values (ex: F=15=(1+2+4+8) from the selected options. See page 23).
3. Enter in right digit address location. **NOTE:** Dark shaded data value box shows option not available.
4. Press to save.

KEYPAD OPTIONS (ADDRESS 1425-1431, 1440-1446)

Keypad 1 Type	ADDRESS 1425	
	LEFT	RIGHT

[Default = blank (*) blank (*)]

Keypad 2 Type	ADDRESS 1426	
	LEFT	RIGHT

[Default = blank (*) blank (*)]

Keypad 3 Type	ADDRESS 1427	
	LEFT	RIGHT

[Default = blank (*) blank (*)]

Keypad 4 Type	ADDRESS 1428	
	LEFT	RIGHT

[Default = blank (*) blank (*)]

Keypad 5 Type	ADDRESS 1429	
	LEFT	RIGHT

[Default = blank (*) blank (*)]

Keypad 6 Type	ADDRESS 1430	
	LEFT	RIGHT

[Default = blank (*) blank (*)]

Keypad 7 Type	ADDRESS 1431	
	LEFT	RIGHT

[Default = blank (*) blank (*)]

KEYPAD TYPE	
LEFT	OPTION
blank (*)	Burg Keypad
2	Wizard Keypad [‡]



[‡]Not for UL or ETL Installations.

KEYPAD ASSIGNMENT	
RIGHT	OPTION
blank (*)	Disabled
1	Active Keypad

KEYPAD TYPE: Up to 7 keypads may be programmed, if they are connected.

NOTE: See Keypad Configuration Mode.

1. Select keypad type for each keypad from the tables shown.
2. Enter in corresponding right and left digit address locations above.
3. Press  to save.

KEYPAD NO.	KEYPAD OPTIONS				ADDRESS 1440-1446			KEYPAD OPTIONS			
	LEFT DATA VALUES (CIRCLE )				LEFT	ADDR	RIGHT	RIGHT DATA VALUES (CIRCLE )			
	RSRVD	PANEL ACCESS	EASY ARMING	AMBUSH				RSRVD	KEYPAD PANIC	KEYPAD AUX. [‡]	KEYPAD FIRE
1	8	4	2	1		1440		8	4	2	1
2	8	4	2	1		1441		8	4	2	1
3	8	4	2	1		1442		8	4	2	1
4	8	4	2	1		1443		8	4	2	1
5	8	4	2	1		1444		8	4	2	1
6	8	4	2	1		1445		8	4	2	1
7	8	4	2	1		1446		8	4	2	1

[Default = blank (*) blank (*) from address 1440-1446]

[‡]NOTE: Keypad Aux. is not to be selected for UL or ETL Installations.

KEYPAD OPTIONS: Select options for any of the 7 keypads.

1. Select the desired option entering the option number (1-8) for each digit.
2. Enter corresponding option number in address location.

NOTE: Dark shaded data value box shows option not available.

3. Press  to save.

TEMPERATURE DISPLAY AT KEYPAD (ADDRESS 1666-1668)

--ZONE 6 TEMPERATURE SENSOR--

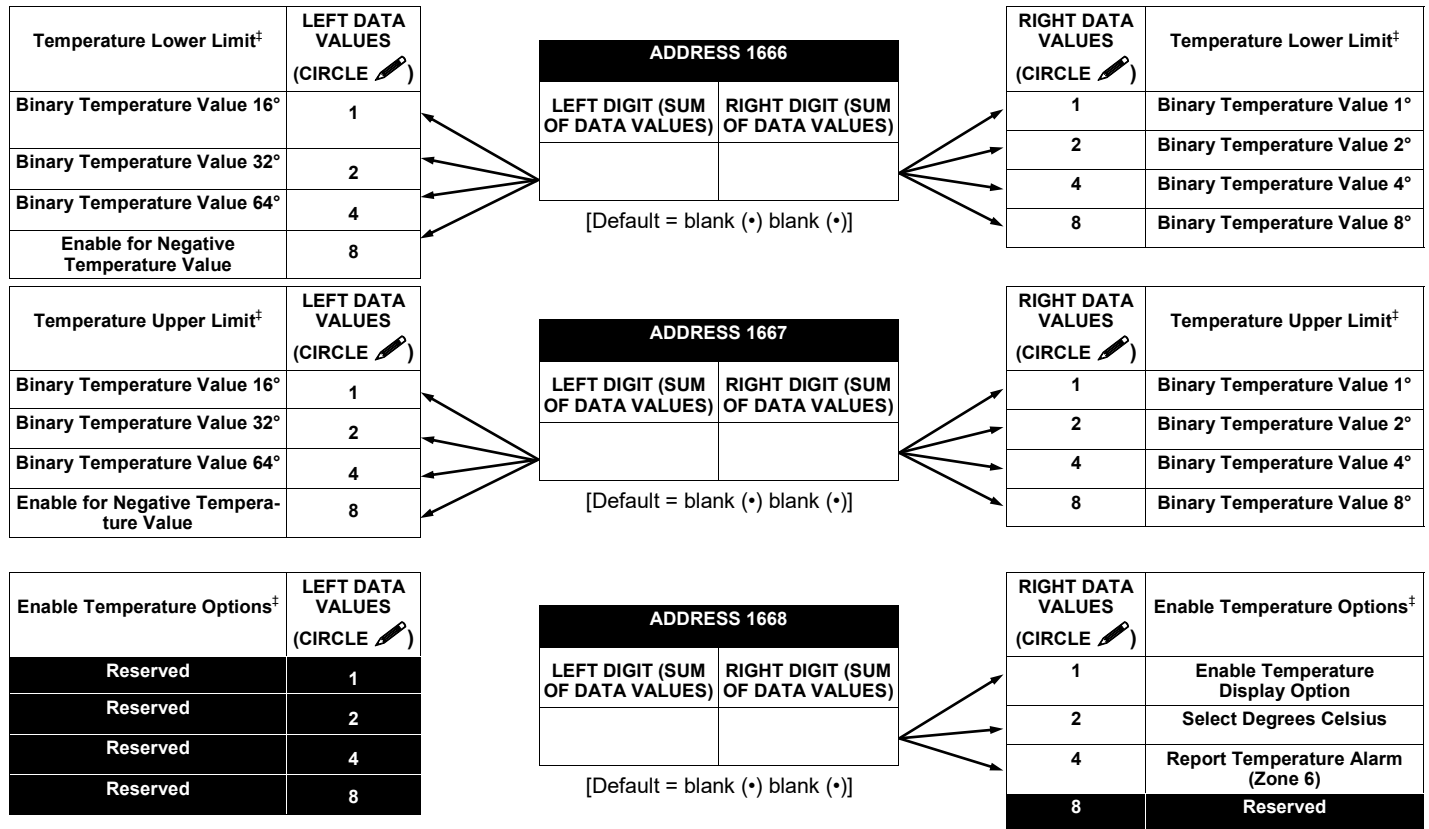

Temperature Display at the Keypad

The temperature is displayed instead of the date on line 2 of the GEM-RP1CAe2 and GEM-K1CA keypads only. The keypads listed on the cover of this manual are able to program, but not display, this Temperature Display feature.

The GEM-RP1CAe2 / GEM-K1CA keypad will display from -22F to 140F (or -30C to 60C). Fahrenheit is the default setting, select Celsius by enabling address 1668 option 2 (right nibble). When this Temperature Display Option is enabled, Zone 6 becomes the input for the GEM-TEMP64 Temperature Sensor module and Zone 6 of the panel becomes inoperative; if Zone Doubling is selected, zones 6, 14 will be inoperative.

Address 1668 option 3 (right nibble) enables Zone 6 to report a temperature problem. Address 1666 (options 1-7) set the lower limit temperature value and address 1667 (options 1-7) sets the upper limit temperature value (both values are set in binary). If the temperature detected by the panel is above or below these set limits, the panel will report an alarm on Zone 6. To function and report properly, Zone 6 must be selected as a reporting zone, 24hr zone in area 1 and auto-resettable. At both 1666 and 1667 addresses, option 8 sets positive or negative temperature. If the temperature of 0 degrees is required, "negative zero" (-0) degrees must be used (+0 or an empty location is not a valid temperature). To simulate the sensor module, a power supply can be connected to Zone 6 and set from .55v to 3.05v to display the whole temperature range. Temperature values are read and updated every 5 seconds. To report an outer limit temperature, the temperature must be out of limits for 2 seconds. To avoid false alarm reports, the limits have a threshold of 5 degrees in the software. Two new logs have been created for temperature out of limits and restore. If the key is depressed and held down for 2 seconds, the date will display for 5 seconds.

In addition, three addresses must be enabled (either via Quickloader or via direct address programming) in order for the **Temperature Display at Keypad** feature to operate.

The following features must be enabled In Quickloader (or in direct address programming):

1. **Keypad Assignment, Temperature Settings** tab, **Enable Temperature Display** (Address 1668, option 1)
2. **Keypad Assignment, Keypad Features** tab, **Enable Keypad Time/Date Display** (Address 1420, option 7)
3. **Keypad Assignment, Keypad Features** tab, **Enable Set Time/Date Message** (Address 2051, option 1)

Note: If these three addresses are set and power (AC and battery) are subsequently removed, they keypad will indicate that the time and date are lost and will need to be reset. See WI1425 for more information.

[‡]This feature not evaluated by UL or ETL.

ZONE OPTIONS - ZONES 1 TO 16 (ADDRESS 0900-1019)

ZONE OPTIONS	ZONES 13-16 LEFT DATA VALUES (CIRCLE)				ADDRESS			ZONES 9-12 RIGHT DATA VALUES (CIRCLE)				ZONES 5-8 LEFT DATA VALUES (CIRCLE)			ADDRESS			ZONES 1-4 RIGHT DATA VALUES (CIRCLE)				
	ZN16	ZN15	ZN14	ZN13	L	ADDR	R	ZN12	ZN11	ZN10	ZN9	ZN8	ZN7	ZN6	ZN5	L	ADDR	R	ZN4	ZN3	ZN2	ZN1
	50ms Loop Response (A)	8	4	2	1		0964		8	4	2	1	8	4	2	1		0900		8	4	2
⊕+ Priority	8	4	2	1		0965		8	4	2	1	8	4	2	1		0901		8	4	2	1
Priority with Bypass	8	4	2	1		0966		8	4	2	1	8	4	2	1		0902		8	4	2	1
⊕+ Auto-Bypass	8	4	2	1		0967		8	4	2	1	8	4	2	1		0903		8	4	2	1
Selective Bypass	8	4	2	1		0968		8	4	2	1	8	4	2	1		0904		8	4	2	1
⊕+ Keyswitch Arming	8	4	2	1		0969		8	4	2	1	8	4	2	1		0905		8	4	2	1
Auto-Bypass Re-entry	8	4	2	1		0970		8	4	2	1	8	4	2	1		0906		8	4	2	1
⊕+ Pre-Alarm Warning	8	4	2	1		0971		8	4	2	1	8	4	2	1		0907		8	4	2	1
Never Arm	8	4	2	1		0972		8	4	2	1	8	4	2	1		0908		8	4	2	1
⊕+ 24-Hour Zone	8	4	2	1		0973		8	4	2	1	8	4	2	1		0909		8	4	2	1
Alarm Output	8	4	2	1		0974		8	4	2	1	8	4	2	1		0910		8	4	2	1
⊕ Pulsed Alarm Output	8	4	2	1		0975		8	4	2	1	8	4	2	1		0911		8	4	2	1
PGM1 Output	8	4	2	1		0976		8	4	2	1	8	4	2	1		0912		8	4	2	1
⊕ PGM2 Output	8	4	2	1		0977		8	4	2	1	8	4	2	1		0913		8	4	2	1
Entry/Exit 1	8	4	2	1		0978		8	4	2	1	8	4	2	1		0914		8	4	2	1
⊕ Entry/Exit 2	8	4	2	1		0979		8	4	2	1	8	4	2	1		0915		8	4	2	1
Exit/Entry Follower	8	4	2	1		0980		8	4	2	1	8	4	2	1		0916		8	4	2	1
⊕+ Auto Reset	8	4	2	1		0981		8	4	2	1	8	4	2	1		0917		8	4	2	1
⊕+ Swinger Shutdown	8	4	2	1		0982		8	4	2	1	8	4	2	1		0918		8	4	2	1
⊕ Chime	8	4	2	1		0983		8	4	2	1	8	4	2	1		0919		8	4	2	1
Abort Delay	8	4	2	1		0984		8	4	2	1	8	4	2	1		0920		8	4	2	1
Power-up Delay	8	4	2	1		0985		8	4	2	1	8	4	2	1		0921		8	4	2	1
Day Zone Open	8	4	2	1		0986		8	4	2	1	8	4	2	1		0922		8	4	2	1
Day Zone Short	8	4	2	1		0987		8	4	2	1	8	4	2	1		0923		8	4	2	1
⊕ Alarm on Day Zone	8	4	2	1		0988		8	4	2	1	8	4	2	1		0924		8	4	2	1
Alarm Telco 1	8	4	2	1		0989		8	4	2	1	8	4	2	1		0925		8	4	2	1
⊕ Alarm Restore 1	8	4	2	1		0990		8	4	2	1	8	4	2	1		0926		8	4	2	1
Trouble Telco 1	8	4	2	1		0991		8	4	2	1	8	4	2	1		0927		8	4	2	1
⊕ Trouble Restore 1	8	4	2	1		0992		8	4	2	1	8	4	2	1		0928		8	4	2	1
Alarm Telco 3	8	4	2	1		0993		8	4	2	1	8	4	2	1		0929		8	4	2	1
⊕ Alarm Restore 3	8	4	2	1		0994		8	4	2	1	8	4	2	1		0930		8	4	2	1
Trouble Telco 3	8	4	2	1		0995		8	4	2	1	8	4	2	1		0931		8	4	2	1
⊕ Trouble Restore 3	8	4	2	1		0996		8	4	2	1	8	4	2	1		0932		8	4	2	1
No EOL Resistor	8	4	2	1		0997		8	4	2	1	8	4	2	1		0933		8	4	2	1
⊕ Trouble on Open	8	4	2	1		0998		8	4	2	1	8	4	2	1		0934		8	4	2	1
Trouble on Short	8	4	2	1		0999		8	4	2	1	8	4	2	1		0935		8	4	2	1
Zone Area 1	8	4	2	1		1000		8	4	2	1	8	4	2	1		0936		8	4	2	1
⊕ Zone Area 2	8	4	2	1		1001		8	4	2	1	8	4	2	1		0937		8	4	2	1
RESERVED	8	4	2	1		1002		8	4	2	1	8	4	2	1		0938		8	4	2	1
RESERVED	8	4	2	1		1003		8	4	2	1	8	4	2	1		0939		8	4	2	1
Interior (Stay) Bypass	8	4	2	1		1004		8	4	2	1	8	4	2	1		0940		8	4	2	1
⊕ Keypad Sounder on Alarm	8	4	2	1		1005		8	4	2	1	8	4	2	1		0941		8	4	2	1
⊕ 2-Wire Smoke Detectors (B)	8	4	2	1	(+)	1006	(+)	8	4	2	1	8	4	2	1		0942	(+)	8	4	2	1
⊕ Fire (C)	8	4	2	1		1007		8	4	2	1	8	4	2	1		0943		8	4	2	1
Fire Alarm Verification (C)	8	4	2	1		1008		8	4	2	1	8	4	2	1		0944		8	4	2	1
RESERVED	8	4	2	1	(+)	1009	(+)	8	4	2	1	8	4	2	1	(+)	0945	(+)	8	4	2	1
Zone ANDing Group 1	8	4	2	1		1010		8	4	2	1	8	4	2	1		0946		8	4	2	1
Zone ANDing Group 2	8	4	2	1		1011		8	4	2	1	8	4	2	1		0947		8	4	2	1
Zone ANDing Group 3	8	4	2	1		1012		8	4	2	1	8	4	2	1		0948		8	4	2	1
Zone ANDing Group 4	8	4	2	1		1013		8	4	2	1	8	4	2	1		0949		8	4	2	1
Sensor Watch	8	4	2	1		1014		8	4	2	1	8	4	2	1		0950		8	4	2	1
RESERVED	8	4	2	1		1015		8	4	2	1	8	4	2	1		0951		8	4	2	1
Chime 2	8	4	2	1		1016		8	4	2	1	8	4	2	1		0952		8	4	2	1
RESERVED	8	4	2	1		1017		8	4	2	1	8	4	2	1		0953		8	4	2	1
RESERVED	8	4	2	1		1018		8	4	2	1	8	4	2	1		0954		8	4	2	1
Carbon Monoxide	8	4	2	1		1019		8	4	2	1	8	4	2	1		0955		8	4	2	1

See steps listed at bottom of page → Step 1 Step 2 Step 4 Step 4 Step 2 Step 2 Step 4 Step 4 Step 2

For notes (A), (B) and (C), ⊕, +, *, see page 44.

1. Select the desired zone option.

ZONE OPTIONS
50ms Loop Response
Priority
Priority with Bypass
Auto-Bypass
Selective Bypass

2. Enable desired options for each zone by drawing a circle around its corresponding binary data value. NOTE: No circle = feature disabled.

ZN04	ZN03	ZN02	ZN01
8	4	2	①

Draw Circle

3. Search table below for data entry.

DIGIT VALUE	DATA ENTRY	DIGIT VALUE	DATA ENTRY
8	4	2	1
8	4	2	①
8	4	②	1
8	4	②	①
8	4	2	1
8	4	2	①
8	4	②	1
8	4	②	①
8	4	2	1

4. Enter data in address locations (left and right digits). Press [Enter] to save.

ADDRESS LOCATION		
L	ADDR	R
blank (+)	0490	1

NOTE: Dark shaded boxes = option not available. See Direct Address Programming Example page 22.

ZONE OPTIONS - ZONES 17 TO 32 (ADDRESS 1029-1147)

ZONE OPTIONS	ZONES 29-32 LEFT DATA VALUES (CIRCLE)				ADDRESS			ZONES 25-28 RIGHT DATA VALUES (CIRCLE)				ZONES 21-24 LEFT DATA VALUES (CIRCLE)				ADDRESS			ZONES 17-20 RIGHT DATA VALUES (CIRCLE)			
	ZN32	ZN31	ZN30	ZN29	L	ADDR	R	ZN28	ZN27	ZN26	ZN25	ZN24	ZN23	ZN22	ZN21	L	ADDR	R	ZN20	ZN19	ZN18	ZN17
	☛ Priority	8	4	2	1		1093		8	4	2	1	8	4	2	1		1029		8	4	2
☛ Priority with Bypass	8	4	2	1		1094		8	4	2	1	8	4	2	1		1030		8	4	2	1
☛ Auto-Bypass	8	4	2	1		1095		8	4	2	1	8	4	2	1		1031		8	4	2	1
☛ Selective Bypass	8	4	2	1		1096		8	4	2	1	8	4	2	1		1032		8	4	2	1
☛ Keyswitch Arming	8	4	2	1		1097		8	4	2	1	8	4	2	1		1033		8	4	2	1
☛ Auto-Bypass Re-entry	8	4	2	1		1098		8	4	2	1	8	4	2	1		1034		8	4	2	1
☛ Pre-Alarm Warning	8	4	2	1		1099		8	4	2	1	8	4	2	1		1035		8	4	2	1
☛ Never Arm	8	4	2	1		1100		8	4	2	1	8	4	2	1		1036		8	4	2	1
☛ 24-Hour Zone	8	4	2	1		1101		8	4	2	1	8	4	2	1		1037		8	4	2	1
☛ Alarm Output	8	4	2	1		1102		8	4	2	1	8	4	2	1		1038		8	4	2	1
☛ Pulsed Alarm Output	8	4	2	1		1103		8	4	2	1	8	4	2	1		1039		8	4	2	1
☛ PGM1 Output	8	4	2	1		1104		8	4	2	1	8	4	2	1		1040		8	4	2	1
☛ PGM2 Output	8	4	2	1		1105		8	4	2	1	8	4	2	1		1041		8	4	2	1
☛ Entry/Exit 1	8	4	2	1		1106		8	4	2	1	8	4	2	1		1042		8	4	2	1
☛ Entry/Exit 2	8	4	2	1		1107		8	4	2	1	8	4	2	1		1043		8	4	2	1
☛ Exit/Entry Follower	8	4	2	1		1108		8	4	2	1	8	4	2	1		1044		8	4	2	1
☛ Auto Reset	8	4	2	1		1109		8	4	2	1	8	4	2	1		1045		8	4	2	1
☛ Swinger Shutdown	8	4	2	1		1110		8	4	2	1	8	4	2	1		1046		8	4	2	1
☛ Chime	8	4	2	1		1111		8	4	2	1	8	4	2	1		1047		8	4	2	1
☛ Abort Delay	8	4	2	1		1112		8	4	2	1	8	4	2	1		1048		8	4	2	1
☛ Power-up Delay	8	4	2	1		1113		8	4	2	1	8	4	2	1		1049		8	4	2	1
☛ Day Zone Open	8	4	2	1		1114		8	4	2	1	8	4	2	1		1050		8	4	2	1
☛ Day Zone Short	8	4	2	1		1115		8	4	2	1	8	4	2	1		1051		8	4	2	1
☛ Alarm on Day Zone	8	4	2	1		1116		8	4	2	1	8	4	2	1		1052		8	4	2	1
☛ Alarm Telco 1	8	4	2	1		1117		8	4	2	1	8	4	2	1		1053		8	4	2	1
☛ Alarm Restore 1	8	4	2	1		1118		8	4	2	1	8	4	2	1		1054		8	4	2	1
☛ Trouble Telco 1	8	4	2	1		1119		8	4	2	1	8	4	2	1		1055		8	4	2	1
☛ Trouble Restore 1	8	4	2	1		1120		8	4	2	1	8	4	2	1		1056		8	4	2	1
☛ Alarm Telco 3	8	4	2	1		1121		8	4	2	1	8	4	2	1		1057		8	4	2	1
☛ Alarm Restore 3	8	4	2	1		1122		8	4	2	1	8	4	2	1		1058		8	4	2	1
☛ Trouble Telco 3	8	4	2	1		1123		8	4	2	1	8	4	2	1		1059		8	4	2	1
☛ Trouble Restore 3	8	4	2	1		1124		8	4	2	1	8	4	2	1		1060		8	4	2	1
☛ No EOL Resistor	8	4	2	1		1125		8	4	2	1	8	4	2	1		1061		8	4	2	1
☛ Trouble on Open	8	4	2	1		1126		8	4	2	1	8	4	2	1		1062		8	4	2	1
☛ Trouble on Short	8	4	2	1		1127		8	4	2	1	8	4	2	1		1063		8	4	2	1
☛ Zone Area 1	8	4	2	1		1128		8	4	2	1	8	4	2	1		1064		8	4	2	1
☛ Zone Area 2	8	4	2	1		1129		8	4	2	1	8	4	2	1		1065		8	4	2	1
RESERVED	8	4	2	1		1130		8	4	2	1	8	4	2	1		1066		8	4	2	1
RESERVED	8	4	2	1		1131		8	4	2	1	8	4	2	1		1067		8	4	2	1
☛ Interior (Stay) Bypass	8	4	2	1		1132		8	4	2	1	8	4	2	1		1068		8	4	2	1
☛ Keypad Sounder on Alarm	8	4	2	1		1133		8	4	2	1	8	4	2	1		1069		8	4	2	1
☛ Fire (C)	8	4	2	1		1135		8	4	2	1	8	4	2	1		1071		8	4	2	1
☛ Fire Alarm Verification (C)	8	4	2	1		1136		8	4	2	1	8	4	2	1		1072		8	4	2	1
☛ Zone ANDing Group 1	8	4	2	1		1138		8	4	2	1	8	4	2	1		1074		8	4	2	1
☛ Zone ANDing Group 2	8	4	2	1		1139		8	4	2	1	8	4	2	1		1075		8	4	2	1
☛ Zone ANDing Group 3	8	4	2	1		1140		8	4	2	1	8	4	2	1		1076		8	4	2	1
☛ Zone ANDing Group 4	8	4	2	1		1141		8	4	2	1	8	4	2	1		1077		8	4	2	1
☛ Sensor Watch	8	4	2	1		1142		8	4	2	1	8	4	2	1		1078		8	4	2	1
RESERVED	8	4	2	1		1143		8	4	2	1	8	4	2	1		1079		8	4	2	1
☛ Chime 2	8	4	2	1		1144		8	4	2	1	8	4	2	1		1080		8	4	2	1
RESERVED	8	4	2	1		1145		8	4	2	1	8	4	2	1		1081		8	4	2	1
RESERVED	8	4	2	1		1146		8	4	2	1	8	4	2	1		1082		8	4	2	1
☛ Carbon Monoxide	8	4	2	1		1147		8	4	2	1	8	4	2	1		1083		8	4	2	1

See Steps listed at bottom of page 43 → Step 1 Step 2 Step 4 Step 4 Step 2 Step 2 Step 4 Step 4 Step 2

NOTES:

- (A) 50ms Loop Response only available for zones 1-8.
 - (B) 2-wire Smoke Detectors only available for zones 7 & 8, and Fire must also be selected.
 - (C) If Fire Alarm Verification is selected, then Fire must also be selected.
 - ☛ When the Easy Program Menu is used, these features are enabled by default.
 - ★ Enabled when "Enable SIA CP-01 Features?" is activated (Answer "Yes" in the EZ Programming Menu).
 - ★ Disabled when "Enable SIA CP-01 Features?" is activated (Answer "Yes" in the EZ Programming Menu). Disable Auto-Reset on non-fire zones for SIA CP-01 installations.
- NOTE:** (Address Location 0942 can only be programmed as "blank (+) blank (+)", "4 blank (+)", "8 blank (+)" or "C blank (+)".

DEFAULTS:

- Zone options indicated are automatically set after exiting the Easy Menu Driven Mode:
- Priority, Selective Bypass, Alarm Output, Auto Reset, Swinger Shutdown and Zone Area 1 are enabled for the total number of zones entered in "** OF ZONES IN AREA1 ENTER # ZONES".
 - Alarm Telco 1 is enabled for the zone number(s) entered in "REPORT ALL ZONES TO CENTRAL ZONES? y/n".
 - Entry/Exit 1 and Chime are enabled for the zone number(s) entered in "ENTRY/EXIT ZONES ENTER ZONE #".
 - Exit/Entry Follower and Interior Bypass are enabled for the zone number(s) entered in "INTERIOR ZONES ENTER ZONE #".
 - Pulse Alarm Output is enabled for the zone number(s) entered in "FIRE ZONES ENTER ZONE #" or "2-WIRE FIRE ZNS ENTER ZONE #".
 - Fire is enabled for the zone number(s) entered in "FIRE ZONES ENTER ZONE #".
 - 2-Wire Smoke Detector is enabled for the zone number(s) entered in "2-WIRE FIRE ZNS ENTER ZONE #".

THIS PAGE INTENTIONALLY LEFT BLANK

THIS PAGE INTENTIONALLY LEFT BLANK

EXTERNAL RELAY CONTROL (ADDRESS 1489-1568)

ADDRESS 1489-1493 (RELAY EVENT 1)									
1489		1490		1491		1492		1493	
RELAY #		AREA		Timeout		Event ID		COND.	
L	R	L	R	L	R	L	R	L	R
(•)		(•)							

ADDRESS 1494-1498 (RELAY EVENT 2)									
1494		1495		1496		1497		1498	
RELAY #		AREA		Timeout		Event ID		COND.	
L	R	L	R	L	R	L	R	L	R
(•)		(•)							

ADDRESS 1499-1503 (RELAY EVENT 3)									
1499		1500		1501		1502		1503	
RELAY #		AREA		Timeout		Event ID		COND.	
L	R	L	R	L	R	L	R	L	R
(•)		(•)							

ADDRESS 1504-1508 (RELAY EVENT 4)									
1504		1505		1506		1507		1508	
RELAY #		AREA		Timeout		Event ID		COND.	
L	R	L	R	L	R	L	R	L	R
(•)		(•)							

ADDRESS 1509-1513 (RELAY EVENT 5)									
1509		1510		1511		1512		1513	
RELAY #		AREA		Timeout		Event ID		COND.	
L	R	L	R	L	R	L	R	L	R
(•)		(•)							

ADDRESS 1514-1518 (RELAY EVENT 6)									
1514		1515		1516		1517		1518	
RELAY #		AREA		Timeout		Event ID		COND.	
L	R	L	R	L	R	L	R	L	R
(•)		(•)							

ADDRESS 1519-1523 (RELAY EVENT 7)									
1519		1520		1521		1522		1523	
RELAY #		AREA		Timeout		Event ID		COND.	
L	R	L	R	L	R	L	R	L	R
(•)		(•)							

ADDRESS 1524-1528 (RELAY EVENT 8)									
1524		1525		1526		1527		1528	
RELAY #		AREA		Timeout		Event ID		COND.	
L	R	L	R	L	R	L	R	L	R
(•)		(•)							

ADDRESS 1529-1533 (RELAY EVENT 9)									
1529		1530		1531		1532		1533	
RELAY #		AREA		Timeout		Event ID		COND.	
L	R	L	R	L	R	L	R	L	R
(•)		(•)							

ADDRESS 1534-1538 (RELAY EVENT 10)									
1534		1535		1536		1537		1538	
RELAY #		AREA		Timeout		Event ID		COND.	
L	R	L	R	L	R	L	R	L	R
(•)		(•)							

ADDRESS 1539-1543 (RELAY EVENT 11)									
1539		1540		1541		1542		1543	
RELAY #		AREA		Timeout		Event ID		COND.	
L	R	L	R	L	R	L	R	L	R
(•)		(•)							

ADDRESS 1544-1548 (RELAY EVENT 12)									
1544		1545		1546		1547		1548	
RELAY #		AREA		Timeout		Event ID		COND.	
L	R	L	R	L	R	L	R	L	R
(•)		(•)							

ADDRESS 1549-1553 (RELAY EVENT 13)									
1549		1550		1551		1552		1553	
RELAY #		AREA		Timeout		Event ID		COND.	
L	R	L	R	L	R	L	R	L	R
(•)		(•)							

ADDRESS 1554-1558 (RELAY EVENT 14)									
1554		1555		1556		1557		1558	
RELAY #		AREA		Timeout		Event ID		COND.	
L	R	L	R	L	R	L	R	L	R
(•)		(•)							

ADDRESS 1559-1563 (RELAY EVENT 15)									
1559		1560		1561		1562		1563	
RELAY #		AREA		Timeout		Event ID		COND.	
L	R	L	R	L	R	L	R	L	R
(•)		(•)							

ADDRESS 1564-1568 (RELAY EVENT 16)									
1564		1565		1566		1567		1568	
RELAY #		AREA		Timeout		Event ID		COND.	
L	R	L	R	L	R	L	R	L	R
(•)		(•)							

[Default = blank (•) blank (•)
from address 1489-1568]

**CONTINUED ON
NEXT PAGE**

 To program, follow the 5 steps below:



RELAY EVENT OPTIONS									
RELAY #		AREA		Timeout		Event ID		COND.	
L	R	L	R	L	R	L	R	L	R
(*)		(*)							

To program, follow the 5 steps below:
STEP 1: RELAY # OPTIONS: The GEM-P1632 supports 8 external relays from Relay Module RM3008. Multiple events may be "mapped" to each relay, up to a maximum of 16 events.
 Select the relay number from **Table 1** (shown on next page); enter in corresponding right digit address location (left digit is not used).

STEP 2: AREA OPTIONS: Each relay event can be assigned to Area 1, Area 2 or both Area 1 & Area 2.
 Select the area from **Table 2** (shown on next page); enter in corresponding right digit address location (left digit is not used).

STEP 3: TIMEOUTS: Each relay event can be assigned a timeout depending on Alarm Type option.
 If Alarm Type (see next page) is selected for timeout in minutes or seconds, select the timeout from **Table 3** (shown on next page) in minutes or seconds and enter in corresponding address location (left digit and right digits). To choose seconds or minutes, see step 5A below. 254 is maximum entry.

STEP 4: EVENT ID CODES: Each relay event can be assigned any of the available event IDs from the table.
 Select 2-digit Event ID from **Table 4** (see next page); enter in corresponding address locations (left and right digit).

STEP 5: RELAY EVENT CONDITION OPTIONS: Each relay event can be assigned an alarm type; and an activation condition; also, select a timeout type for each.
 5A. Select Alarm Type and Timeout Type from **Table 5A** (shown on next page); enter in corresponding address location (left digit).
 5B. Select Activation from from **Table 5B** (shown on next page); enter in corresponding address location (right digit).

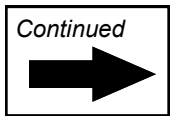
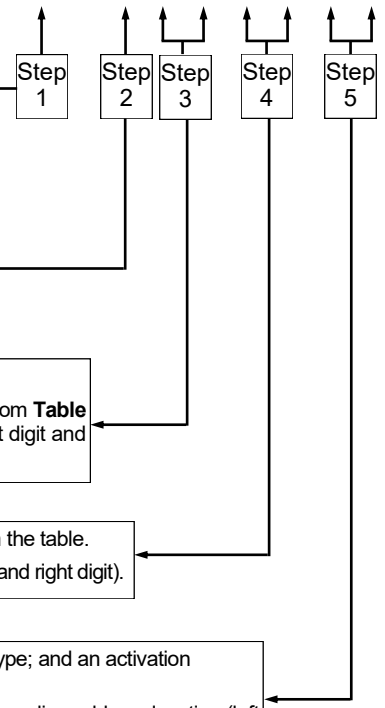

RELAY EVENT OPTIONS				
RELAY #	AREA	TIMEOUT	EVENT ID	COND.
See Table 1 below (right nibble)	See Table 2 below (right nibble)	Enter a Time period, in seconds or minutes	See Table 4 below	See Tables 5A & 5B below

Table 1

DATA ENTRY	RELAY #
blank (*)	NONE
1	1
2	2
3	3
4	4
5	5
6	6
7	7
8	8

Table 2

DATA ENTRY	TURN OFF ON AREA DISARM
blank (*)	NONE
1	Area 1
2	Area 2
3	Area 1 & Area 2

Table 4

EVENT ID CODES		
DATA ENTRIES		OPTION
LEFT	RIGHT	
blank (*)	blank (*)	Area 1 Arm
blank (*)	1	Area 2 Arm
blank (*)	8	Zone 1
blank (*)	9	Zone 2
blank (*)	0	Zone 3
blank (*)	B	Zone 4
blank (*)	C	Zone 5
blank (*)	D	Zone 6
blank (*)	E	Zone 7
blank (*)	F	Zone 8
1	blank (*)	Zone 9
1	1	Zone 10
1	2	Zone 11
1	3	Zone 12
1	4	Zone 13
1	5	Zone 14
1	6	Zone 15
1	7	Zone 16
1	8	Zone 17
1	9	Zone 18
1	0	Zone 19
1	B	Zone 20
1	C	Zone 21
1	D	Zone 22
1	E	Zone 23
1	F	Zone 24
2	blank (*)	Zone 25
2	1	Zone 26
2	2	Zone 27
2	3	Zone 28
2	4	Zone 29
2	5	Zone 30
2	6	Zone 31
2	7	Zone 32

Table 4 (cont'd)

EVENT ID CODES		
DATA ENTRIES		OPTION
LEFT	RIGHT	
3	blank (*)	Area 1 KP Ambush
3	1	Area 1 KP Panic
3	2	Area 1 KP Fire
3	3	Area 1 KP Aux ‡
3	4	Area 1 KP Tamper
3	5	Area 1 Fail to Open
3	6	Area 1 Fail to Close
3	8	Area 2 KP Ambush
3	9	Area 2 KP Panic
3	0	Area 2 KP Fire
3	B	Area 2 KP Aux ‡
3	C	Area 2 KP Tamper
3	D	Area 2 Fail to Open
3	E	Area 2 Fail to Close
4	blank (*)	Test Timer
4	3	Memory Fail
4	4	Low Battery
4	5	AC Fail
4	6	EZM Tamper
4	7	Alarm Supervisory
4	D	RF Receiver Trouble (Tamper/Fail)
4	E	Wireless TX Tamper
4	F	Wireless TX Trouble (LB/Supervisory)
C	8	Area 1 Arming AWAY
C	9	Area 2 Arming AWAY
D	blank (*)	Keypad Fail
D	1	EZM Fail
D	2	Quickloader Device Control
D	5	General System Alarm
D	8	Area 1 General System Alarm
D	9	Area 2 General System Alarm
F	blank (*)	Relay Control Group 1
F	1	Relay Control Group 2
F	8	Entry Relay Area 1
F	9	Entry Relay Area 2

Table 5A

RELAY EVENT ALARM TYPE OPTIONS		
LEFT DATA ENTRIES	ALARM TYPE	TIMEOUT TYPE
blank (*)	Burglary	Minutes
1	Fire	Minutes
4	Day Zone	Minutes
8	Burglary	Seconds
9	Fire	Seconds
C	Day Zone	Seconds

Table 5B

RELAY EVENT ACTIVATION CONDITIONS	
RIGHT DATA ENTRIES	OPTIONS
1	Alarm
2	Restore
3	Trouble
4	Trouble Restore
5	Follow Zone

‡ NOTE: Keypad Auxiliary is not to be selected for UL or ETL Installations.
 NOTE: Keypad Tamper must be enabled in UL or ETL installations.

RF RECEIVER & SUPERVISORY TIMER OPTIONS (ADDRESS 2029-2044 & 2056)

Number of RF Receivers	ADDRESS 2056		DATA ENTRIES	RF Receiver(s)
	LEFT	RIGHT		
	blank (*)		RIGHT	
			blank (*)	None
			1	1
			2	2

Default for Number of Receivers depends on Easy Menu Question for RF Transmitters.

RF RECEIVERS: Up to 2 RF Receivers may be programmed.

1. Select the number of receivers from the table shown.
2. Enter in corresponding right digit address location shown (left digit is not used).
3. Press  to save.

RF SUPERVISORY TIMER	RF TRANSMITTER	ADDRESS 2029-2036			RF SUPERVISORY TIMER	RF TRANSMITTER	ADDRESS 2037-2044		
		LEFT	ADDR	RIGHT			LEFT	ADDR	RIGHT
Type 0	Window/Door, 2 Pt.	blank (*)	2029		Type 8	Smoke Detector	blank (*)	2037	
Type 1	Window/Door, 2 Pt.	blank (*)	2030		Type 9	RESERVED	blank (*)	2038	
Type 2	Window/Door, 2 Pt.	blank (*)	2031		Type A	Dual Tech.	blank (*)	2039	
Type 3	Window/Door, 2 Pt.	blank (*)	2032		Type B	RESERVED	blank (*)	2040	
Type 4	RESERVED	blank (*)	2033		Type C	Window/Door, 4 Pt.	blank (*)	2041	
Type 5	PIR	blank (*)	2034		Type D	PIR	blank (*)	2042	
Type 6	PIR	blank (*)	2035		Type E	Smoke Detector	blank (*)	2043	
Type 7	Smoke Detector	blank (*)	2036		Type F	Napco Glass Break	blank (*)	2044	

[Default = blank (*) blank (*) from address 2029-2044]

RF SUPERVISORY TIMERS		
DATA ENTRIES		DELAY
LEFT	RIGHT	
blank (*)	3	90 min.
blank (*)	4	120 min.
blank (*)	5	150 min.
blank (*)	6	180 min.
blank (*)	7	210 min.
blank (*)	8	240 min.
blank (*)	9	270 min.
blank (*)	0	300 min.
blank (*)	B	330 min.
blank (*)	C	360 min.
blank (*)	D	390 min.
blank (*)	E	420 min.
blank (*)	F	450 min.

RF SUPERVISORY TIMERS: RF Supervisory Timers may be programmed for each type of transmitter used. A transmitter will send a transmission every time it is tripped, when there is NO activity, the transmitter sends a status transmission about once an hour. If the receiver does NOT receive ANY signal (a trip or a status) from a transmitter in the time specified for transmitter type, a system trouble "WIRELESS TROUBLE/EQ4-NN SERVICE" will be displayed at the keypad.

1. Select timer delay from the table shown. Timers are programmed in increments of 30 minutes each. Valid entries are [blank (*)3]-[blank (*)F], 90 minutes-450 minutes.
2. Enter in corresponding address locations above right digit only (left digit is not used).
3. Press  to save.

NOTE: These timers apply only to Supervised RF Transmitters (see RF Transmitters in Easy Menu Driven Mode Programming).

CLEAR PROGRAM OPTIONS (ADDRESS 2285 & 2286)

2285 XX

GEM-RP1CAe2 Keypad
and Zone Descriptions are maintained.

2285 XX

GEM-RP2ASe2 Keypad

Clear Dealer Program (Erases Dealer Program)



This erases the dealer program. Use this feature to start a customized default program. Program Data and System Status Memory is erased where Scheduled Data

Access address 2285, then press the  button. Data entry is not allowed.

NOTE: Enter Easy Menu Driven Program Mode to program system again.

2286 XX

GEM-RP1CAe2 Keypad

2286 XX

GEM-RP2ASe2 Keypad

Cold Start (Erases Entire Program)



This erases the entire program including Dealer Program by erasing Program Data, Zone Description Data and System Status Data (similar to a new panel).







Access address 2286, then press the  button. Data entry is not allowed.

NOTE: Some features (schedules) can only be programmed again with the Downloading Software. **NOTE:** Some features (schedules) can only be programmed again with the Downloading Software. If power fails, time and date restarts at 00:00:00 and a date of 01-01-04 (January 1, 2004).



USER PROGRAM MODE



PRELIMINARY INFORMATION

The User Program Mode is covered in detail in the operating instructions for the keypad in use.

-  The Program Mode cannot be accessed while the communicator is transmitting except during the first three minutes after power-up.
 -  After entering codes or data, press the save  button. *Data will not be stored into memory unless this button is pressed.*
 -  If the keypad is in the Program Mode and no activity is detected for longer than 4 minutes, a steady tone will sound.
 -  Press the  button to silence the sounder and exit the User Program Mode.
- Use the  button to manually scroll the display at the end of each programming line.

ACCESSING USER PROGRAM MODE

1. Press  

New Panel (Default User Code = 123)
Existing Panel (Any Code with User Program Option Enabled)
2. Press  Until "TURNON PROG Y/N" (GEM-RP2ASe2/GEM-K2AS) or "11" (GEM-RP3DGTL/GEM-K3DGTL or GEM-RP4RFC/GEM-K4RF) appears on the LCD screen.
3. Press  To Enter User Program Mode.
4. Press  to Exit User Program Mode when finished.

USER CODES

GEM-K2AS Keypad

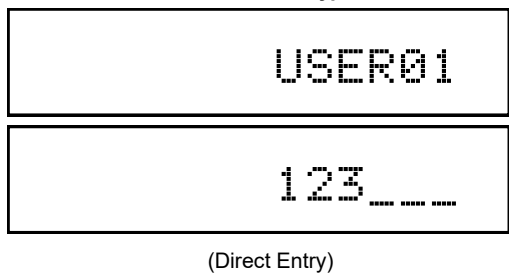

To Program User Codes

1. Enter 2-digit User Number (01-32) directly using number buttons (0-9).
2. Press the **[MENU]** button.
3. Enter Code (1-6 digits) directly using number buttons (0-9).
4. Press the **[ENTER]** button to save each code.

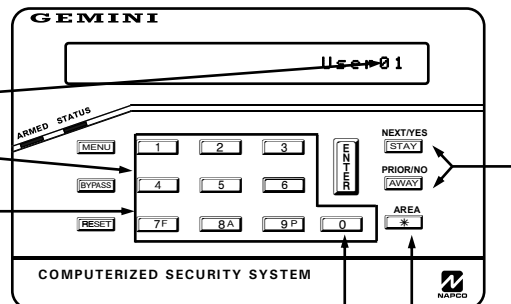

NOTE: Press **[*]** **[0]** button to clear character at cursor.
To continue press **[STAY]** or **[AWAY]** button.

Programming User Codes with GEM-K2AS Keypad

GEM-K3DGTL Keypad

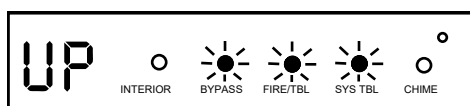

User Program Mode

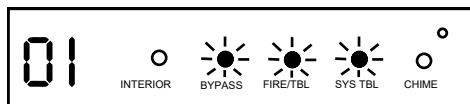

User Number

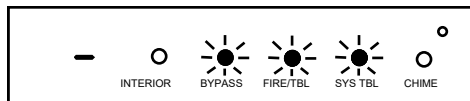

User Code (Direct Entry)

Us-

To Program User Codes

1. Enter 2-digit User Number (01-32) directly using number buttons (0-9).
2. Press the **[MENU]** button.
3. Enter Code (1-6 digits) directly using number buttons (0-9).
4. Press the **[ENTER]** button to save each code.

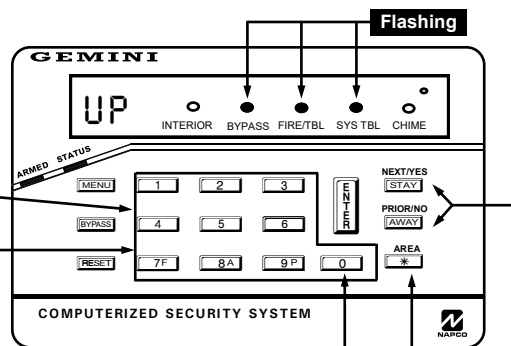

NOTE: Press **[*]** **[0]** button to clear character at cursor.
To continue press **[STAY]** or **[AWAY]** button.

Programming User Codes with GEM-K3DGTL Keypad

GEM-K4RF Keypad

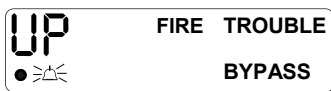

User Program Mode



User Number



User Code (Direct Entry)

To Program User Codes

1. Enter 2-digit User Number (01-32) directly using number buttons (0-9).
2. Press the **[MENU]** button.
3. Enter Code (1-6 digits) directly using number buttons (0-9).
4. Press the **[ENTER]** button to save each code.

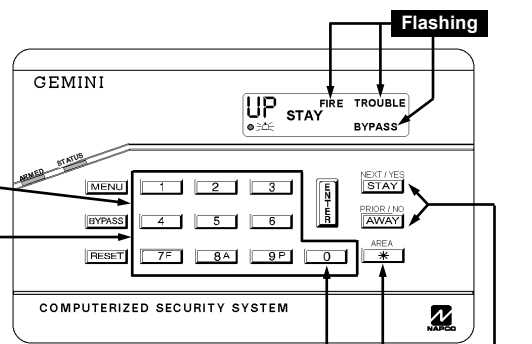

NOTE: Press **[*]** **[0]** button to clear character at cursor.
To continue press **[STAY]** or **[AWAY]** button.

Programming User Codes with GEM-K4RF Keypad

KEYPAD CONFIGURATION MODE

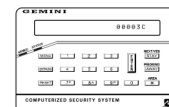

This section will focus on configuring the GEM-RP2ASe2/GEM-K2AS, GEM-RP3DGTL/GEM-K3DGTL and GEM-RP4RFC/GEM-K4RF Keypads. For ease of programming, it is recommended that a GEM-RP1CAe2 or a GEM-K1CA be selected (see W1897 for Programming Instructions using the GEM-RP1CAe2 or GEM-K1CA keypads). **Note:** The GEM-K4RF keypad provides a maximum of 16 points of coverage when used with the GEM-P1632 firmware version 9 (or less). With version 10 (or higher), the GEM-K4RF keypad provides a maximum of 32 points. Use Kit SE1632-3 to upgrade the GEM-P1632 firmware to version 10.

KEYPAD INSTALLATION

Each keypad must be assigned an address number (1–7) and each requires its own configuration procedure (see CONFIGURING THE KEYPADS, which follows, and DIRECT ADDRESS KEYPAD AREA OPTIONS). At least 1 keypad must be used; only 1 is required for a single-area Commercial Burglary installation.

GEM-RP2ASe2/GEM-K2AS - are utility LCD keypads combining several preset LCD words with a limited message line. **NOTE:** Due to space constraints, available messages are abbreviated and will scroll automatically.

CONFIGURING THE KEYPADS

Configuring the GEM-RP2ASe2/GEM-K2AS, GEM-RP3DGTL/GEM-K3DGTL and GEM-RP4RFC/GEM-K4RF Keypads

Up to 7 GEM-RP2ASe2/GEM-K2AS, GEM-RP3DGTL/GEM-K3DGTL and/or GEM-RP4RFC/GEM-K4RF keypads may be connected to the panel (Keypads 1–7). Each must be configured for a keypad address. In addition, the keypad may be configured to disable (a) touchpad backlight; (b) LCD backlight; and (c) entry sounder. Keypads are configured by the proper selection of jumpers. Refer to the label on the circuit board insulation paper for jumper locations and a summary of settings.

KEYPAD ADDRESS

If more than one keypad is installed:

- ☞ Each must be assigned a unique address (that is, no two keypads may be numbered alike).
- ☞ Keypads must be addressed consecutively (that is, missing numbers are not permitted).

Assign the keypad address number by selecting Jumpers J1–3 in accordance with the table at right.

KEYPAD NUMBER	KEYPAD ADDRESS SETTING			PARK
	1	2	3	
1	OFF or ON	OFF	OFF	STORE SPARE JUMPER AT THIS POSITION
2	OFF	ON	OFF	
3	ON	ON	OFF	
4	OFF	OFF	OFF	
5	ON	OFF	ON	
6	OFF	ON	ON	
7	ON	ON	ON	

TOUCHPAD BACK LIGHT

Cut Jumper A to disable touch pad backlighting to conserve 11mA standby current.

LCD BACKLIGHT

Cut Jumper B to disable LCD backlighting.

DISABLE SOUNDER

Cut Jumper C to disable the sounder. (Do not disable in UL or ETL applications).

ALPHABETICAL INDEX

1400HZ HANDSHAKE/KISSOFF, ADDRESS 0461.....	30	AREA BELL CONTROL OPTIONS (ADDRESS 1473, 1474).....	37
1400HZ HANDSHAKE/KISSOFF, ADDRESS 0483.....	30	AREA BELL CONTROL OPTIONS (ADDRESS 1477, 1478).....	38
1400HZ HANDSHAKE/KISSOFF, ADDRESS 0505.....	30	AREA BELL CONTROL OPTIONS (ADDRESS 1481, 1482).....	39
2300HZ HANDSHAKE/KISSOFF, ADDRESS 0461.....	30	AREA BELL CONTROL OPTIONS (ADDRESS 1485, 1486).....	40
2300HZ HANDSHAKE/KISSOFF, ADDRESS 0483.....	30	AREA BURG OUTPUT SILENCED	37
2300HZ HANDSHAKE/KISSOFF, ADDRESS 0505.....	30	AREA OPTIONS.....	10
24 HOUR AUXILIARY (MODEM CODE).....	33	AREA PGM1 OUTPUT SILENCED	39
24 HOUR ZONES IN AREA 1	7, 14, 15	AREA PGM2 BURG OUTPUT SILENCED	40
24-HOUR ZONE (ZONE OPTION)	43, 44,	AREA PULSED BURG OUTPUT SILENCED.....	38
2-WIRE FIRE ZONES	13	AUTO BELL TEST ON ARMING, ADDRESS 1421.....	28
2-WIRE FIRE ZONES IN AREA 1	6	AUTO BYPASS RE-ENTRY ZONES.....	8, 14, 15
2-WIRE SMOKE DETECTORS (ZONE OPTION).....	43	AUTO RESET (ZONE OPTION)	43, 44
3/1 WITH EXTENDED RESTORES, ADDRESS 0461	30	AUTO RESET AFTER BURGLARY OUTPUT TIMEOUT, ADDRESS 1421	28
3/1 WITH EXTENDED RESTORES, ADDRESS 0483	30	AUTO-BYPASS (ZONE OPTION).....	43, 44
3/1 WITH EXTENDED RESTORES, ADDRESS 0505	30	AUTO-BYPASS RE-ENTRY (ZONE OPTION)	43, 44
50 MS LOOP RESPONSE ZONES.....	7	AUTOMATIC INTERIOR BYPASS/EASY EXIT, ADDRESS 1424.....	28
50MS LOOP RESPONSE (ZONE OPTION).....	43	AUX 1/AUX 2 OPTIONS	11, 18
50MS LOOP RESPONSE ZONES	14, 15	AUX OUTPUT ACTIVATED ON ALARM ZONES.....	14, 15
ABORT DELAY (ZONE OPTION).....	43, 44	AUX OUTPUT ACTIVATED ON ALARM ZONES.....	7
ABORT DELAY, ADDRESS 1417.....	24	AUXILIARY ALARM (MODEM CODE).....	33
AC FAIL REPORT DELAY, ADDRESS 1419.....	24	BACKUP REPORT ON TELCO 1 & 2, ADDRESS 0788	32
ACCESS CONTROL ON PGM2 OUTPUT, ADDRESS 1421.....	28	BURGLARY (MODEM CODE).....	33
ACCESSING DEALER PROGRAM MODE.....	5	BURGLARY OUTPUT TURNS OFF UPON DISARM.....	37
ACCESSING USER PROGRAM MODE.....	51	CALLBACK METHOD.....	4
ACTIVATE DOWNLOAD.....	4	CALLBACK TELEPHONE NUMBER, ADDRESS 0526-0545.....	25
ADEMCO POINT ID (RECEIVER FORMAT).....	30	CANCEL NEXT TEST TIMER ON ANY REPORT, ADDRESS 0788 ..	32
ADEMCO SLOW, SILENT KNIGHT SLOW (RECEIVER FORMAT) ..	30	CARBON MONOXIDE (ZONE OPTION) ADDRESS 0955, 1019.....	43
ALARM ON DAY ZONE (ZONE OPTION)	43, 44	CARBON MONOXIDE (ZONE OPTION) ADDRESS 1083, 1147.....	44
ALARM OUTPUT (ZONE OPTION).....	43, 44	CENTRAL STATION RECEIVER 1 ACCOUNT NUMBER.....	9, 16
ALARM OUTPUT TIMEOUT, ADDRESS 1414.....	25	CENTRAL STATION RECEIVER 1 FORMAT	9, 16
ALARM RESTORE 1 (ZONE OPTION).....	43, 44	CENTRAL STATION RECEIVER 1 TELEPHONE NUMBER.....	8, 16
ALARM RESTORE 3 (ZONE OPTION).....	43, 44	CHANGE PULSE OUTPUT TO TEMPORAL OUTPUT, ADDRESS 1422	28
ALARM TELCO 1 (ZONE OPTION).....	43, 44	CHANGING OR CANCELING A CODE.....	10, 17
ALARM TELCO 3 (ZONE OPTION).....	43, 44	CHIME (ZONE OPTION)	43, 44
AREA 1 SYSTEM EVENT/TROUBLE.....	26	CHIME 2 (ZONE OPTION)	43, 44
AREA 2 SYSTEM EVENT/TROUBLE.....	26	CHIME 2 ZONES IN AREA 1.....	7, 14, 15
AREA ARMING OPTIONS (ADDRESS 1469-1470).....	36		

ALPHABETICAL INDEX (CONT'D)

CHIME TIME, ADDRESS 1418.....	24	DISABLE 2ND CALL ANS. MACHINE OVERRIDE, ADDRESS 1424	28
CHIME ZONES IN AREA 1	7, 14, 15	DISABLE AUTO DIAL TONE DETECT, ADDRESS 0788	32
CHIRP OUTPUT ON KEYFOB ARM/DISARM, ADDRESS 1422.....	28	DISABLE CALL WAITING ON 1ST ATTEMPT, ADDRESS 2053	29
CLEAR DEALER PROGRAM	51	DISABLE CALLBACK DOWNLOAD, ADDRESS 1422.....	28
CLEAR PROGRAM	12, 19	DISABLE CLOSING REPORTS, ADDRESS 0786.....	32
CLEAR PROGRAM OPTIONS (ADDRESS 2285 & 2286).....	51	DISABLE CODE REQUIRED FOR EZ BYPASS, ADDRESS 1424	28
CLOSING REPORT ONLY ON CONDITIONAL CLOSE, ADDRESS 1420	28	DISABLE KEYPAD FUNCTION MODE DOWNLOAD, ADDRESS 1422	28
COLD START	51	DISABLE KEYPAD INSTANT MODE, ADDRESS 1421	28
CONFIGURING THE KEYPADS	53	DISABLE OPENING REPORTS, ADDRESS 0785	32
CONVENTIONS USED IN THIS MANUAL	23	DISABLE SOUNDER	53
CS AREA & SYSTEM REPORTING OPTIONS (ADDRESS 0785, 0786 & 0788).....	32	DISABLE SYSTEM TROUBLE AUDIBLE TIMEOUT, ADDRESS 2051	29
CS RECEIVER 1 FORMAT, ADDRESS 0460	30	DISABLE WAIT FOR HANDSHAKE ON TRANSMIT, ADDRESS 0788	32
CS RECEIVER 2 FORMAT, ADDRESS 0482.....	30	DISABLE WAIT FOR SILENCE (PAGER FORMAT), ADDRESS 0788	32
CS RECEIVER 3 FORMAT, ADDRESS 0504.....	30	DISABLE ZONE FAULT SCROLLING, ADDRESS 1420.....	28
CS RECEIVER OPTIONS (ADDRESS 0460-0525).....	30	DON'T CLEAR PGM2 OUTPUT WITH DISARM, ADDRESS 1424	28
CS RECEIVER TELEPHONE NUMBERS.....	30	DOWNLOAD/CALLBACK OPTIONS (ADDRESS 2059 & 0526-0545)	25
CS SUBSCRIBER ID OPTIONS (ADDRESS 0560-0667).....	31	DOWNLOADING FROM A COMPUTER	4
CS SYSTEM REPORT OPTIONS.....	32	EASY MENU DRIVEN PROGRAM MODE	5
CS SYSTEM REPORTING CODES	32	EASY MENU-DRIVEN PROGRAM MODE	4
CS SYSTEM REPORTING OPTIONS (ADDRESS 0670-0705).....	32	EASY PROGRAM MENU	13
CS USER REPORTING OPTIONS (ADDRESS 0800-0813).....	34	ENABLE "K SERIES" STYLE KEYPADS, ADDRESS 2051	29
CS USER REPORTING OPTIONS (ADDRESS 0818-0831).....	35	ENABLE ALARM OUTPUT ON TELCO FAIL ONLY WHEN ARMED, ADDRESS 1423.....	28
CS ZONE REPORTING OPTIONS (ADDRESS 0720-0751).....	33	ENABLE AUTOARM IF NOT CLOSED AT END OF WINDOW, ADDRESS 1420.....	28
CUSTOMIZING A DEFAULT PROGRAM	5	ENABLE BURG OUTPUT CHIRP ON KEYFOB	8, 14, 15
DAY ZONE OPEN (ZONE OPTION).....	43, 44	ENABLE CANCEL REPORT TO TELCO 3, ADDRESS 2051	29
DAY ZONE SHORT (ZONE OPTION)	43, 44	ENABLE CP-01 EGRESS TONES ONLY, ADDRESS 2053	29
DEALER CODE.....	11, 19	ENABLE CP-01 LIMITS, ADDRESS 2053.....	29
DEALER CODE (DEFAULT).....	5	ENABLE GEM-PRINT MODULE, ADDRESS 2051.....	29
DEALER PROGRAM.....	5	ENABLE GLOBAL AMBUSH CODE, ADDRESS 1422.....	28
DEALER PROGRAM MODE	4	ENABLE KEYPAD 1 ONLY PROGRAMMING, ADDRESS 2053.....	29
DEFAULT DEALER CODE	5	ENABLE KEYPAD SET TIME/DATE MESSAGE, ADDRESS 2051	29
DIGITAL DIALER RPT ENTER /EXIT TEST MODE, ADDRESS 2053	29	ENABLE KEYPAD TIME/DATE DISPLAY, ADDRESS 1420.....	28
DIRECT ADDRESS PROGRAM MODE.....	20	ENABLE KEYPAD TIME/DATE DISPLAY, ADDRESS 1420.....	28
DIRECT ADDRESS PROGRAM MODE (ACCESS).....	22	ENABLE LINE-FAULT TEST, ADDRESS 1423	28
DIRECT ADDRESS PROGRAM MODE KEYPAD COMMANDS	21	ENABLE LOCAL ALARM ON FIRST ZONE AND TRIP, ADDRESS 1421	28
DISABLE [ON/OFF] AS EASY EXIT, ADDRESS 2051.....	29		

ALPHABETICAL INDEX (CONT'D)

ENABLE MANAGER'S MODE, ADDRESS 1421	28	FUNCTION MODE	4
ENABLE NO EOLR ZONES.....	8, 14, 15	GAS ALARM (MODEM CODE).....	33
ENABLE RESIDENTIAL FIRE, ADDRESS 1422.....	28	GEM-P1632 WIRING DIAGRAM	64
ENABLE SIA CP-01	8, 14, 15	GEM-RP2ASE2/GEM-K2AS KEYPAD EASY PROGRAM MENU.....	6
ENABLE TCP/IP AES RPT (ADDRESS 0461)	30	GEM-RP3DGTL/GEM-K3DGTL AND GEM-RP4RFC/GEM-K4RF KEYPAD EASY PROGRAM MENU	13
ENABLE TCP/IP AES RPT (ADDRESS 0483)	30	GENERAL PROGRAMMING STEPS.....	23
ENABLE TCP/IP AES RPT (ADDRESS 0505).....	30	GLOBAL AMBUSH CODE, ADDRESS 2045.....	26
ENABLE TCP/IP COMMUNICATIONS, ADDRESS 2054	29	GLOBAL SYSTEM EVENT/TROUBLE.....	26
ENABLE TELCO LINE FAULT TEST	8, 14, 15	HEAT ALARM (MODEM CODE).....	33
ENABLE ZONE DOUBLING (ZONES 9-16), ADDRESS 1423	28	HOLD UP (MODEM CODE)	33
ENABLE ZONE NUMBER ON PULSE ALARM, ADDRESS 0461	30	INCL. SEL./GRP. BYPASS IN COND. CLOSE /STATUS, ADDRESS 1420	28
ENABLE ZONE NUMBER ON PULSE ALARM, ADDRESS 0483	30	INHIBIT SYSTEM TROUBLE AUDIBLE AT KEYPAD, ADDRESS 1423	28
ENABLE ZONE NUMBER ON PULSE ALARM, ADDRESS 0505	30	INTERIOR (STAY) BYPASS (ZONE OPTION).....	43, 44
ENTER USER CODES.....	9, 16	INTERIOR (STAY) BYPASS ZONES IN AREA 1	7
ENTRY DELAY 2, ADDRESS 0002.....	24	INTERIOR NORMALLY BYPASSED, ADDRESS 1422.....	28
ENTRY DELAY, ADDRESS 0001.....	24	INTERIOR ZONES	14, 15
ENTRY/EXIT 1 (ZONE OPTION)	43, 44	KEYFOB TRANSMITTERS	18
ENTRY/EXIT 2 (ZONE OPTION)	43, 44	KEYFOB TRANSMITTERS AS ARM/DISARM & CONTROL DEVICES	11
ERASE DEALER PROGRAM	51	KEYFOB TRANSMITTERS AS ZONE INPUT DEVICES	11, 18
ERASE ENTIRE PROGRAM	51	KEYFOB ZONE ASSIGNMENT	11, 18
EXIT DEALER PROGRAM MODE	12, 19	KEYPAD ADDRESS	53
EXIT DELAY, ADDRESS 0000	24	KEYPAD ADDRESS PROGRAM MODE DISPLAY	21
EXIT TIME RESTART, ADDRESS 2053.....	29	KEYPAD CONFIGURATION MODE	53
EXIT/ENTRY DELAYS.....	24	KEYPAD EASY PROGRAM MENU.....	13
EXIT/ENTRY FOLLOWER (ZONE OPTION).....	43, 44	KEYPAD INSTALLATION.....	53
EXIT/ENTRY ZONES.....	13	KEYPAD OPTIONS (ADDRESS 1425-1431, 1440-1446).....	41
EXIT/ENTRY ZONES IN AREA 1	6	KEYPAD PROGRAMMING	4
EXIT/ENTRY2 ZONES IN AREA 1	7, 15	KEYPAD PROGRAMMING OVERVIEW	20
EXTERNAL RELAY CONTROL (ADDRESS 1489-1568).....	47	KEYPAD SOUNDER ON ALARM (ZONE OPTION).....	43, 44
EZM GROUP OPTIONS (ADDRESS 1455-1460).....	36	KEYPAD SOUNDER ON ALARM ZONES.....	7, 14, 15
FIRE (ZONE OPTION).....	43	KEYPAD TYPE.....	41
FIRE (MODEM CODE)	33	KEYSWITCH ARMING (ZONE OPTION).....	43, 44
FIRE (ZONE OPTION).....	44	LCD BACKLIGHT	53
FIRE ALARM VERIFICATION (ZONE OPTION)	43	LEADING DIGITS FOR PAGER FORMAT, ADDRESS 0546-0547	25
FIRE ALARM VERIFICATION (ZONE OPTION).....	44		
FIRE ZONES.....	13		
FIRE ZONES IN AREA 1	6		

ALPHABETICAL INDEX (CONT'D)

LINE-FAULT TEST ONLY WHEN ARMED, ADDRESS 1423.....	28	PROGRAMMING TIMEOUTS.....	24
LOCAL DOWNLOADING	4	PROGRAMMING USER CODES	52
LOCAL OR CENTRAL STATION REPORTING SYSTEM	6	PULSE ALARM OUTPUT TIMEOUT, ADDRESS 1415.....	25
LOCAL SYSTEM OR C.S. REPORTING SYSTEM.....	13	PULSE EVENT CODE	33
LUG E15 AREA 1 ARMED AWAY ONLY, ADDRESS 2052.....	29	PULSED ALARM OUTPUT (ZONE OPTION).....	43, 44
MAINTAINED KEYSWITCH ARMING, ADDRESS 1421	28	PULSED BURG OUTPUT TURNS OFF UPON DISARM.....	38
MODEM CODES	33	QUICK ENROLL METHOD.....	10, 17
MULTIPLE AREA SYSTEM.....	6	RADIONICS FAST (RECEIVER FORMAT)	30
NEVER ARM (ZONE OPTION).....	43, 44	RADIONICS, DCI, FRANKLIN SLOW (RECEIVER FORMAT)	30
NO EOL RESISTOR (ZONE OPTION).....	43, 44	RECEIVER TELCO OPTIONS	30
NUMBER OF KEYPADS	16	REMOTE DOWNLOADING.....	4
NUMBER OF KEYPADS IN AREA 1	8	REPORT CANCEL WINDOW, ADDRESS 2055	24
NUMBER OF RF RECEIVERS, ADDRESS 2056	50	RESET DAY ZONE WITH ARM/DISARM ONLY, ADDRESS 1422.....	28
NUMBER OF RINGS BEFORE PICKUP, ADDRESS 2059	25	RESOUND ON WIRELESS SMOKE LOW BATTERY, ADDRESS 1424	28
OPENING REPORT ONLY AFTER ALARM REPORT, ADDRESS 1420	28	RF RECEIVER & SUPERVISORY TIMER OPTIONS (ADDRESS 2029-2044 & 2056).....	50
OUTPUT TIMEOUTS	25	RF RECEIVERS (NUMBER OF), ADDRESS 2056	50
OUTPUT TURNS OFF UPON DISARM.....	37, 38, 39, 40	RF SUPERVISORY TIMERS	50
PAGER (RECEIVER FORMAT).....	30	RF TRANSMITTER POINTS	10, 17
PAGER FORMAT OPTIONS (ADDRESS 0546 & 0547)	25	ROTARY DIALING	32
PANEL ZONE DOUBLING	6, 13	RPT EXIT ERR/RECENT CLOSE, ADDRESS 2053.....	29
PANIC (MODEM CODE).....	33	SELECT ALARM OUTPUT FOR KEYFOB CHIRP, ADDRESS 1423.....	28
PCI2000/3000	4	SELECTIVE BYPASS (ZONE OPTION).....	43, 44
PGM ON RF TRANSMITTER TAMPER, ADDRESS 2052.....	29	SENSOR WATCH (ZONE OPTION).....	43, 44
PGM1 OUTPUT (ZONE OPTION).....	43, 44	SENSOR WATCH TIME, ADDRESS 2050	24
PGM1 OUTPUT TIMEOUT, ADDRESS 1416.....	25	SENSOR WATCH ZONES	7, 14, 15
PGM1 OUTPUT TURNS OFF UPON DISARM	39	SIA (RECEIVER FORMAT)	30
PGM2 OUTPUT (ZONE OPTION).....	43, 44	SILENT KNIGHT FAST (RECEIVER FORMAT).....	30
PGM2 OUTPUT ACCESS CNTRL TIMEOUT, ADDRESS 1413	24	SINGLE DIGIT ONLY, ADDRESS 0461	30
PGM2 OUTPUT TIMEOUT, ADDRESS 1412.....	25	SINGLE DIGIT ONLY, ADDRESS 0483.....	30
PGM2 OUTPUT TURNS OFF UPON DISARM	40	SINGLE DIGIT ONLY, ADDRESS 0505.....	30
POWER-UP DELAY (ZONE OPTION).....	43, 44	SOUND ALARM ON EXIT ERROR, ADDRESS 2053	29
PRE-ALARM WARNING (ZONE OPTION).....	43, 44	STATUS REPORT, ADDRESS 1420.....	28
PRIORITY (ZONE OPTION).....	43, 44	SUM CHECK, ADDRESS 0461.....	30
PRIORITY AREA ARMING.....	36	SUM CHECK, ADDRESS 0483.....	30
PRIORITY WITH BYPASS (ZONE OPTION).....	43, 44	SUM CHECK, ADDRESS 0505.....	30
PROGRAMMING STEPS	23	SUPERVISORY TIMERS, RF	50

ALPHABETICAL INDEX (CONT'D)

SUPPRESS BYPASS REMINDER WHEN ARMED, ADDRESS 142128	
SWINGER SHUTDOWN (ZONE OPTION).....	43, 44
SYSTEM DELAYS & TIMEOUTS (ADDRESS 0000-0002, 1413, 1417, 2050 & 2055).....	24
SYSTEM DELAYS & TIMEOUTS (ADDRESS 1418 & 1419).....	24
SYSTEM OPTIONS (ADDRESS 0836-0871 & 2045).....	26
SYSTEM OPTIONS (ADDRESS 1420-1424).....	28
SYSTEM OPTIONS (ADDRESS 2051-2054).....	29
SYSTEM OUTPUT TIMEOUTS (ADDRESS 1412 & 1414-1416).....	25
SYSTEM PROGRAMMING OPTIONS.....	4
SYSTEM RESPONSE ACTIVATED BY GLOBAL EVENT/TROUBLE	26
TCP/IP PANEL/SITE INITIATED FUNCTIONS (ADDRESS 2054).....	29
TEMPERATURE DISPLAY AT KEYPAD (ADDRESS 1666-1668).....	42
TOTAL NUMBER OF ZONES IN AREA 1.....	6
TOUCHPAD BACK LIGHT.....	53
TOUCH-TONE DIALING ONLY, ADDRESS 0788.....	32
TOUCH-TONE DIALING W/ROTARY BACKUP, ADDRESS 0788.....	32
TROUBLE ON OPEN (ZONE OPTION).....	43, 44
TROUBLE ON SHORT (ZONE OPTION).....	43, 44
TROUBLE RESTORE 1 (ZONE OPTION).....	43, 44
TROUBLE RESTORE 3 (ZONE OPTION).....	43, 44
TROUBLE TELCO 1 (ZONE OPTION).....	43, 44
TROUBLE TELCO 3 (ZONE OPTION).....	43, 44
TWO-WIRE FIRE ZONES.....	13
UNIVERSAL HIGH SPEED (RECEIVER FORMAT).....	30
USER CODES.....	9
USER CODES, PROGRAMMING.....	52
USER OPTIONS.....	17
USER PROGRAM MODE.....	4, 51
VERI-PHONE AUDIO PRIORITY OVER ALARMS, ADDRESS 1424	28
VERI-PHONE ZONES TRIP PGM2 OUTPUT, ADDRESS 1424.....	28
WIRELESS TROUBLE ACTIVATES TELCO 1, ADDRESS 1423.....	28
WIRELESS TROUBLE ACTIVATES TELCO 3, ADDRESS 1423.....	28
WIRING DIAGRAM.....	64
ZONE 6 TEMPERATURE SENSOR.....	42
ZONE ANDING GROUP 1-4 (ZONE OPTION).....	43, 44
ZONE AREA 1 (ZONE OPTION).....	43, 44
ZONE AREA 2 (ZONE OPTION).....	43, 44
ZONE OPTIONS - ZONES 1 TO 16 (ADDRESS 0900-1019).....	43
ZONE OPTIONS - ZONES 17 TO 32 (ADDRESS 1029-1147).....	44

ADDRESS NUMBER LOCATION INDEX

ADDRESS 0000	EXIT DELAY	24
ADDRESS 0000-0002	SYSTEM DELAYS & TIMEOUTS	24
ADDRESS 0001	Entry Delay	24
ADDRESS 0002	ENTRY DELAY 2	24
ADDRESS 0460	CS Receiver 1 Format	30
ADDRESS 0460-0525	CS RECEIVER OPTIONS	30
ADDRESS 0461	1400Hz Handshake/Kissoff	30
ADDRESS 0461	2300Hz Handshake/Kissoff	30
ADDRESS 0461	3/1 with Extended Restores	30
ADDRESS 0461	Enable Zone Number on Pulse Alarm	30
ADDRESS 0461	Single Digit Only	30
ADDRESS 0461	Sum Check	30
ADDRESS 0461	Enable TCP/IP AES RPT	30
ADDRESS 0482	CS Receiver 2 Format	30
ADDRESS 0483	1400Hz Handshake/Kissoff	30
ADDRESS 0483	2300Hz Handshake/Kissoff	30
ADDRESS 0483	3/1 with Extended Restores	30
ADDRESS 0483	Enable Zone Number on Pulse Alarm	30
ADDRESS 0483	Single Digit Only	30
ADDRESS 0483	Sum Check	30
ADDRESS 0483	Enable TCP/IP AES RPT	30
ADDRESS 0504	CS Receiver 3 Format	30
ADDRESS 0505	1400Hz Handshake/Kissoff	30
ADDRESS 0505	2300Hz Handshake/Kissoff	30
ADDRESS 0505	3/1 with Extended Restores	30
ADDRESS 0505	Enable Zone Number on Pulse Alarm	30
ADDRESS 0505	Single Digit Only	30
ADDRESS 0505	Sum Check	30
ADDRESS 0505	Enable TCP/IP AES RPT	30
ADDRESS 0526-0545	Callback Telephone Number	25
ADDRESS 0526-0545	DOWNLOAD/CALLBACK OPTIONS	25
ADDRESS 0546-0547	LEADING DIGITS FOR PAGER FORMAT	25
ADDRESS 0546-0547	PAGER FORMAT OPTIONS	25
ADDRESS 0560-0667	CS SUBSCRIBER ID OPTIONS	31
ADDRESS 0670-0705	CS SYSTEM REPORTING OPTIONS	32
ADDRESS 0720-0751	CS ZONE REPORTING OPTIONS	33
ADDRESS 0785	CS AREA & SYSTEM REPORTING OPTIONS	32
ADDRESS 0785	DISABLE OPENING REPORTS	32
ADDRESS 0786	CS AREA & SYSTEM REPORTING OPTIONS	32
ADDRESS 0786	DISABLE CLOSING REPORTS	32
ADDRESS 0788	Backup Report on Telco 1 & 2	32
ADDRESS 0788	Cancel Next Test Timer on any Report	32
ADDRESS 0788	CS AREA & SYSTEM REPORTING OPTIONS	32
ADDRESS 0788	Disable Auto Dial Tone Detect	32
ADDRESS 0788	Disable Wait for Handshake on Transmit	32
ADDRESS 0788	Disable Wait for Silence (Pager Format)	32
ADDRESS 0788	Touch-tone Dialing Only	32
ADDRESS 0788	Touch-tone Dialing w/Rotary Backup	32
ADDRESS 0800-0813	CS USER REPORTING OPTIONS	34
ADDRESS 0818-0831	CS USER REPORTING OPTIONS	35

ADDRESS NUMBER LOCATION INDEX (CONT'D)

ADDRESS 0836-0871.....	SYSTEM OPTIONS	26
ADDRESS 0900-1019.....	ZONE OPTIONS - ZONES 1 TO 16.....	43
ADDRESS 1029-1147.....	ZONE OPTIONS - ZONES 17 TO 32.....	44
ADDRESS 1412.....	PGM2 Output Timeout	25
ADDRESS 1412.....	SYSTEM OUTPUT TIMEOUTS	25
ADDRESS 1413.....	PGM2 Output Access Cntrl Timeout	24
ADDRESS 1413.....	SYSTEM DELAYS & TIMEOUTS.....	24
ADDRESS 1414.....	Alarm Output Timeout	25
ADDRESS 1414-1416.....	SYSTEM OUTPUT TIMEOUTS	25
ADDRESS 1415.....	Pulse Alarm Output Timeout	25
ADDRESS 1416.....	PGM1 Output Timeout	25
ADDRESS 1417.....	ABORT DELAY	24
ADDRESS 1417.....	SYSTEM DELAYS & TIMEOUTS.....	24
ADDRESS 1418.....	CHIME TIME	24
ADDRESS 1418-1419.....	SYSTEM DELAYS & TIMEOUTS.....	24
ADDRESS 1419.....	AC Fail Report Delay.....	24
ADDRESS 1420.....	Closing Report Only on Conditional Close	28
ADDRESS 1420.....	Disable Zone Fault Scrolling	28
ADDRESS 1420.....	Enable AutoArm if not closed at end of Window	28
ADDRESS 1420.....	Enable Keypad Time/Date Display.....	28
ADDRESS 1420.....	Incl. Sel./Grp. Bypass in Cond. Close /Status	28
ADDRESS 1420.....	Opening Report Only after Alarm Report	28
ADDRESS 1420.....	Status Report	28
ADDRESS 1420-1424.....	SYSTEM OPTIONS	28
ADDRESS 1421.....	Access Control on PGM2 Output	28
ADDRESS 1421.....	Auto Bell Test on Arming.....	28
ADDRESS 1421.....	Auto Reset after Burglary Output Timeout	28
ADDRESS 1421.....	Disable Keypad Instant Mode	28
ADDRESS 1421.....	Enable Local Alarm on First Zone AND Trip	28
ADDRESS 1421.....	Enable Manager's Mode.....	28
ADDRESS 1421.....	Maintained Keyswitch Arming	28
ADDRESS 1421.....	Suppress Bypass Reminder when Armed.....	28
ADDRESS 1422.....	Change Pulse Output to Temporal Output	28
ADDRESS 1422.....	Chirp Output on Keyfob Arm/Disarm.....	28
ADDRESS 1422.....	Disable Callback Download.....	28
ADDRESS 1422.....	Disable Keypad Function Mode Download.....	28
ADDRESS 1422.....	Enable Global Ambush Code	28
ADDRESS 1422.....	Enable Residential Fire	28
ADDRESS 1422.....	Interior Normally Bypassed	28
ADDRESS 1422.....	Reset Day Zone with Arm/Disarm Only.....	28
ADDRESS 1423.....	Enable Alarm Output on Telco Fail only when Armed	28
ADDRESS 1423.....	Enable Line-Fault Test	28
ADDRESS 1423.....	Enable Zone Doubling (Zones 9-16)	28
ADDRESS 1423.....	Inhibit System Trouble Audible at Keypad.....	28
ADDRESS 1423.....	Line-Fault Test only when Armed.....	28
ADDRESS 1423.....	Select Alarm Output for Keyfob Chirp	28
ADDRESS 1423.....	Wireless Trouble Activates Telco 1	28
ADDRESS 1423.....	Wireless Trouble Activates Telco 3	28
ADDRESS 1424.....	Automatic Interior Bypass/Easy Exit.....	28
ADDRESS 1424.....	Disable 2nd Call Ans. Machine Override.....	28
ADDRESS 1424.....	Disable Code Required for EZ Bypass.....	28

ADDRESS NUMBER LOCATION INDEX (CONT'D)

ADDRESS 1424	Don't Clear PGM2 Output with Disarm	28
ADDRESS 1424	Resound on Wireless Smoke Low Battery	28
ADDRESS 1424	Veri-phone Audio Priority Over Alarms	28
ADDRESS 1424	Veri-phone Zones Trip PGM2 Output	28
ADDRESS 1425-1431	KEYPAD OPTIONS	41
ADDRESS 1440-1446	KEYPAD OPTIONS	41
ADDRESS 1455-1460	EZM GROUP OPTIONS	36
ADDRESS 1469-1470	AREA ARMING OPTIONS	36
ADDRESS 1473	AREA BELL CONTROL OPTIONS	37
ADDRESS 1474	AREA BELL CONTROL OPTIONS	37
ADDRESS 1477	AREA BELL CONTROL OPTIONS	38
ADDRESS 1478	AREA BELL CONTROL OPTIONS	38
ADDRESS 1481	AREA BELL CONTROL OPTIONS	39
ADDRESS 1482	AREA BELL CONTROL OPTIONS	39
ADDRESS 1485	AREA BELL CONTROL OPTIONS	40
ADDRESS 1486	AREA BELL CONTROL OPTIONS	40
ADDRESS 1489-1568	EXTERNAL RELAY CONTROL	47
ADDRESS 1666-1668	Temperature Display at Keypad	42
ADDRESS 2029-2044	RF RECEIVER & supervisory timer options	50
ADDRESS 2045	GLOBAL AMBUSH CODE	26
ADDRESS 2045	SYSTEM OPTIONS	26
ADDRESS 2050	Sensor Watch Time	24
ADDRESS 2050	SYSTEM DELAYS & TIMEOUTS	24
ADDRESS 2051	Disable [ON/OFF] as Easy Exit	29
ADDRESS 2051	Disable System Trouble Audible Timeout	29
ADDRESS 2051	Enable "K Series" Style Keypads	29
ADDRESS 2051	Enable Cancel Report to Telco 3	29
ADDRESS 2051	Enable GEM-PRINT Module	29
ADDRESS 2051	Enable Keypad Set Time/Date Message	29
ADDRESS 2051-2054	SYSTEM OPTIONS	29
ADDRESS 2052	Lug E15 Area 1 Armed Away Only	29
ADDRESS 2052	PGM on RF Transmitter Tamper	29
ADDRESS 2053	Digital Dialer Rpt Enter /Exit Test Mode	29
ADDRESS 2053	Disable Call Waiting on 1st Attempt	29
ADDRESS 2053	Enable CP-01 Egress Tones Only	29
ADDRESS 2053	Enable CP-01 Limits	29
ADDRESS 2053	Enable Keypad 1 Only Programming	29
ADDRESS 2053	Exit Time Restart	29
ADDRESS 2053	Rpt Exit Err/Recent Close	29
ADDRESS 2053	Sound Alarm On Exit Error	29
ADDRESS 2054	Enable TCP/IP Communications	29
ADDRESS 2054	TCP/IP Panel/Site Initiated Functions	29
ADDRESS 2055	Report Cancel Window	24
ADDRESS 2055	SYSTEM DELAYS & TIMEOUTS	24
ADDRESS 2056	Number of RF Receivers	50
ADDRESS 2056	RF RECEIVER & supervisory timer options	50
ADDRESS 2056	RF Receivers (number of)	50
ADDRESS 2059	DOWNLOAD/CALLBACK OPTIONS	25
ADDRESS 2059	NUMBER OF RINGS BEFORE PICKUP	25
ADDRESS 2285-2286	Clear program OPTIONS	51

NOTES

NOTES

GEM-P1632 WIRING DIAGRAM



NAPCO SECURITY SYSTEMS, INC.
AMITYVILLE, N.Y. 11701

GEM-P1632 WIRING DIAGRAM

(REFER TO OPERATION AND INSTALLATION INSTRUCTIONS W808)

RESIDENTIAL AND COMMERCIAL BURGLARY**

16.5V TRANSFORMER	STANDBY BATTERY	COMBINED STANDBY CURRENT	ALARM CURRENT	STANDBY CURRENT TIME
40VA/50VA	7AH	450mA	2.0A	4 HOURS
20VA*	4AH	500mA	2.0A	4 HOURS
20VA*	7AH	500mA	2.0A	6 HOURS

RESIDENTIAL FIRE

16.5V TRANSFORMER	STANDBY BATTERY	COMBINED STANDBY CURRENT	ALARM CURRENT	STANDBY TIME
40VA/50VA	7AH	120mA	520mA(1)	24 HOURS
40VA/50VA*	2-7AH	360mA	280mA(1)	24 HOURS
20VA*	7AH	120mA	360mA(1)	24 HOURS
20VA*	2-7AH	360mA	120mA(1)	24 HOURS

(1) ALARM CURRENT CAN BE INCREASED BY REDUCING STANDBY CURRENT BY THE SAME AMOUNT.

* NOT PRESENTLY EVALUATED BY U.L.
** COMMERCIAL BURGLARY IS NOT PRESENTLY EVALUATED BY U.L.

This equipment should be installed in accordance with Chapter 2 of the National Fire Alarm Code, ANSI/NFPA 72-1996 (National Fire Protection Association Batterymarch Park, Quincy, MA 02269), and local codes. Information describing proper installation, operation, testing, maintenance, evacuation planning, and repair service is to be provided with this equipment. UL Listed Limited Energy Cable is required.

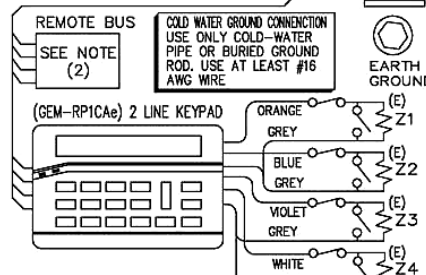
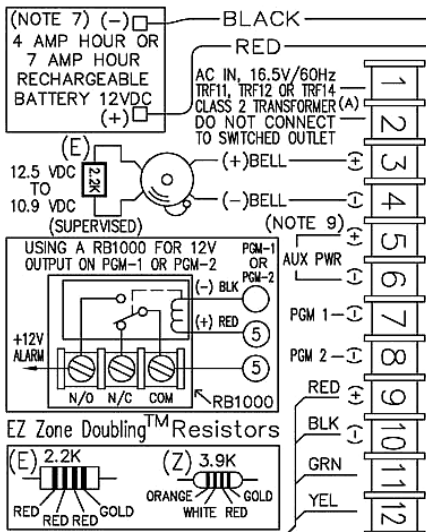

THIS UNIT INCLUDES AN ALARM VERIFICATION FEATURE THAT WILL RESULT IN A DELAY OF THE SYSTEM ALARM SIGNAL FROM THE INDICATED CIRCUITS. THE TOTAL DELAY (CONTROL UNIT PLUS SMOKE DETECTORS) SHALL NOT EXCEED 60 SECONDS. NO OTHER SMOKE DETECTORS SHALL BE CONNECTED TO THESE CIRCUITS UNLESS APPROVED BY THE LOCAL AUTHORITY HAVING JURISDICTION.

CIRCUIT	CONTROL UNIT	SMOKE DETECTORS	ZONES	DELAY-SEC
MODEL	DELAY-SEC.			

THE DELAY (POWER UP) (STARTUP) TIME MARKED ON THE INSTALLATION WIRING DIAGRAM OF THE SMOKE DETECTOR OR ON THE INSTALLED SMOKE DETECTOR(S) IS TO BE USED.

- NOTES:
- ALARM CURRENT CAN BE INCREASED BY REDUCING STANDBY CURRENT BY THE SAME AMOUNT.
 - THE FOLLOWING DEVICES MAY BE PLACED ON THE REMOTE BUS: GEM-RP1CAe2, GEM-RP2ASe2, GEM-EZM816, GEM-X10, GEM-RECV8, GEM-RECV16, RM3008, GEM-EVA1, WIZARD2, GEM-K1CA, GEM-K2AS, GEM-K3DGT1 AND GEM-RECV96.
 - REFER TO W808 FOR LISTINGS.
 - COMBINED STANDBY CURRENT = KEYPAD CURRENT + AUX CURRENT + FIRE POWER + PGM1 AND PGM2 CURRENT.
 - UNIT INTENDED TO BE MOUNTED VERTICAL ON WALL.
 - REFER TO W808 FOR COMPATIBLE TWO WIRE SMOKE DETECTORS. DO NOT MIX DIFFERENT MODELS.
 - RECOMMENDED BATTERIES YUASA NP4-12 OR NP7-12. BATTERY SHOULD BE REPLACED EVERY 5 YEARS.
 - THIS PANEL SHALL BE CHECKED BY A QUALIFIED TECHNICIAN AT LEAST ONCE EVERY 3 YEARS.
 - AUX. POWER AND FIRE POWER VOLTAGE RATING: 12.5 VDC TO 11.7 VDC. THE PANEL WILL DISREGARD INPUTS FROM ALL SENSORS WHEN VOLTAGE DROPS BELOW 8.5V
 - A.C MUST BE DISCONNECTED WHEN PERFORMING WEEKLY TESTS.
 - THIS PANEL ONLY SUPPORTS ONE SMOKE DETECTOR IN ALARM FOR EACH ZONE.
 - DISABLE AUTO-RESET ON NON-FIRE ZONES FOR SIA CP-01 INSTALLATIONS.
 - DESIGN EVALUATED TO BE IN ACCORDANCE WITH SIA CP-01 CONTROL PANEL STANDARD FEATURES FOR FALSE ALARM REDUCTION.

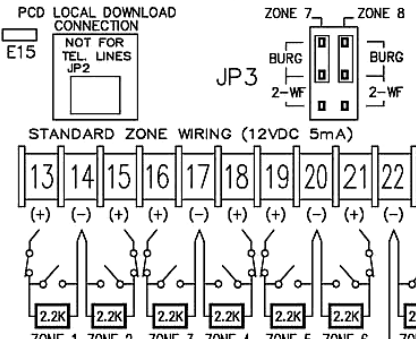

WARNING
TO PREVENT RISK OF ELECTRIC SHOCK DISCONNECT TELEPHONE LINES PRIOR TO SERVICING.

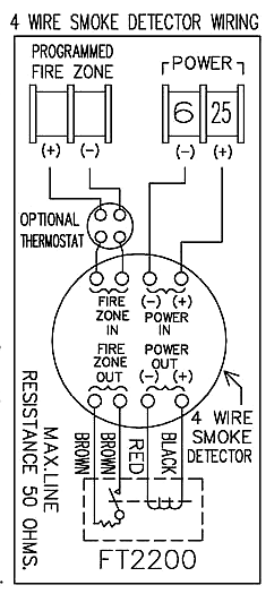
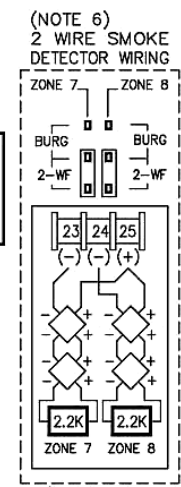
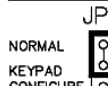
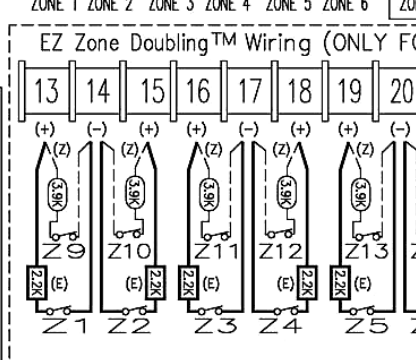

LA1469G

Smoke Detector Compatibility Identifier GEM-P1632