

# ► Replacement Lamps

## LED LAMPS

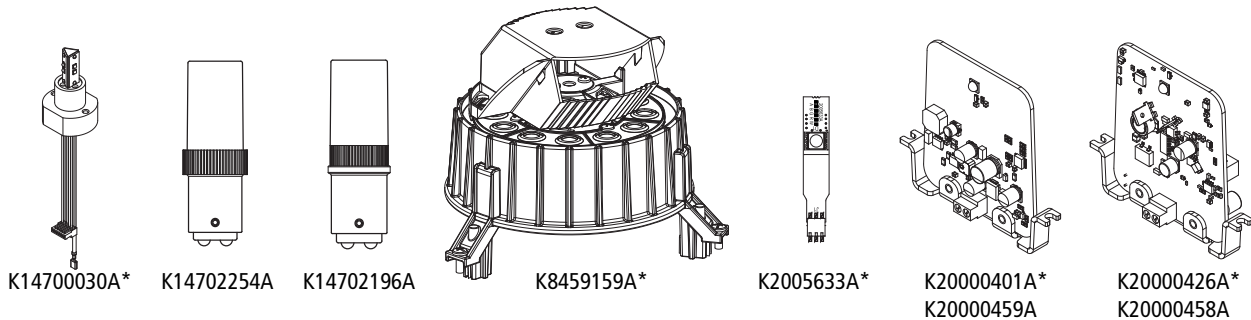

Part	Description	Voltage	Applicable Models
<b>K14700030A-A</b>	LED Module, Amber	All Voltages	191XL, 191XL-CN, 225XL, 225XL-N, 27XL
<b>K14700030A-B</b>	LED Module, Blue	All Voltages	191XL, 191XL-CN, 225XL, 225XL-N, 27XL
<b>K14700030A-G</b>	LED Module, Green	All Voltages	191XL, 191XL-CN, 225XL, 225XL-N, 27XL
<b>K14700030A-R</b>	LED Module, Red	All Voltages	191XL, 191XL-CN, 225XL, 225XL-N, 27XL
<b>K14700030A-W</b>	LED Module, White	All Voltages	191XL, 191XL-CN, 225XL, 225XL-N, 27XL
<b>K14700030A-Y</b>	LED Module, Yellow	All Voltages	191XL, 191XL-CN, 225XL, 225XL-N, 27XL
<b>K14702254A</b>	LED Lamp	24V	121ALED, 121ALED-N, 121X*
<b>K14702196A</b>	LED Lamp	120V	121SLED, 121SLED-N, 121X*
<b>K8459159A-A</b>	LED PCBA Motor Module, Amber	120V	371LED, 371LEDX
<b>K8459159A-B</b>	LED PCBA Motor Module, Blue	120V	371LED, 371LEDX
<b>K8459159A-G</b>	LED PCBA Motor Module, Green	120V	371LED, 371LEDX
<b>K8459159A-R</b>	LED PCBA Motor Module, Red	120V	371LED, 371LEDX
<b>K8459159A-W</b>	LED PCBA Motor Module, White	120V	371LED, 371LEDX
<b>K2005633A-A</b>	LED PCBA, Amber	All Voltages	AV1-LED
<b>K2005633A-B</b>	LED PCBA, Blue	All Voltages	AV1-LED
<b>K2005633A-G</b>	LED PCBA, Green	All Voltages	AV1-LED
<b>K2005633A-W</b>	LED PCBA, White	All Voltages	AV1-LED
<b>K20000401A</b>	LED PCBA, Amber, Red, Green	12-24V	FB2LED, FB2LEDX
<b>K20000401A-01</b>	LED PCBA, Clear, Blue	12-24V	FB2LED, FB2LEDX
<b>K20000426A</b>	LED PCBA, Amber, Red, Green	120-240V	FB2LED, FB2LEDX
<b>K20000426A-01</b>	LED PCBA, Clear, Blue	120-240V	FB2LED, FB2LEDX
<b>K20000459A</b>	LED PCBA, Quad Color	12-24VDC	FB2LED-QC, FB2LEDX-QC
<b>K20000458A</b>	LED PCBA, Quad Color	120-240VAC	FB2LED-QC, FB2LEDX-QC
<b>K859501400-A</b>	LED PCBA, Amber	24V	G-LED
<b>K859501400-B</b>	LED PCBA, Blue	24V	G-LED

\*Model 121X replacement LED lamp does not retrofit into the incandescent housing without impairing the light output. For incandescent replacements, we recommend upgrading to the new 121X LED.

# ► Replacement Lamps

## LED LAMPS

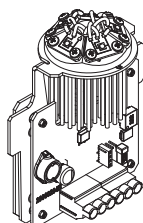

K859501400\*  
K859501401\*

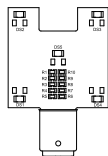

K8107199A\*

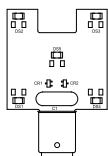

K8107200A\*

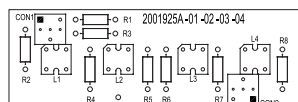

K2001925A\*

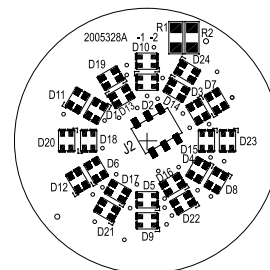

K2005328A\*

Part	Description	Voltage	Applicable Models
K859501400-G	LED PCBA, Green	24V	G-LED
K859501400-R	LED PCBA, Red	24V	G-LED
K859501400-W	LED PCBA, White	24V	G-LED
K859501401-A	LED PCBA, Amber	120-240V	G-LED
K859501401-B	LED PCBA, Blue	120-240V	G-LED
K859501401-G	LED PCBA, Green	120-240V	G-LED
K859501401-R	LED PCBA, Red	120-240V	G-LED
K859501401-W	LED PCBA, White	120-240V	G-LED
K8107199A	LED PCBA, Amber	24V	LP3 LED, LSLD
K8107199A-01	LED PCBA, Red	24V	LP3 LED, LSLD
K8107199A-02	LED PCBA, Green	24V	LP3 LED, LSLD
K8107199A-03	LED PCBA, Blue	24V	LP3 LED, LSLD
K8107199A-04	LED PCBA, Clear,	24V	LP3 LED, LSLD
K8107200A	LED PCBA, Amber	120V	LP3 LED, LSLD
K8107200A-01	LED PCBA, Red	120V	LP3 LED, LSLD
K8107200A-02	LED PCBA, Green	120V	LP3 LED, LSLD
K8107200A-03	LED PCBA, Blue	120V	LP3 LED, LSLD
K8107200A-04	LED PCBA, Clear	120V	LP3 LED, LSLD
K2001925A	LED PCBA, Red	24V	SCB, SCC
K2001925A-01	LED PCBA, Amber	24V	SCB, SCC
K2001925A-02	LED PCBA, Blue	24V	SCB, SCC
K2001925A-03	LED PCBA, Green	24V	SCB, SCC
K2001925A-04	LED PCBA, Clear	24V	SCB, SCC
K2005328A	LED PCBA, Tri-Color	All Voltages	USI, USIX
K2005328A-01	LED PCBA, Quad-Color	All Voltages	USI, USIX

\* Indicates color or voltage variation needed for full part number

## ► Replacement Lamps

### STROBE TUBES

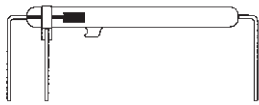

K149128A

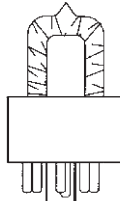

K149122B

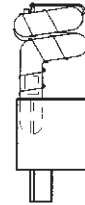

K8107177A

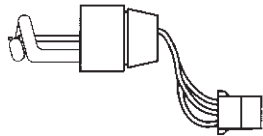

K8107159A

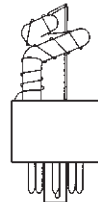

K8107178A

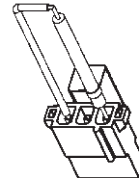

K149130A

Part	Description	Voltage	Applicable Models
<b>K149128A</b>	Strobe Tube	All Voltages	141ST, LP1, TELC, VALS
<b>K149122B</b>	Strobe Tube	All Voltages	151XST, 154XSTHI, 154XSTHI-CN
<b>K8107177A</b>	Strobe Tube	All Voltages	224XST, 224XSTHI, 225XST, 225XST-I, 225XST-N, FB2PST, FB2PST-I, FB24ST, FB24STHI, FB24STHI-CN, WV450X
<b>K8107159A</b>	Strobe Tube	All Voltages	24XST, 24XSTHI, 24XSTHI-CN, FSEX, FSEX-HI
<b>K8107178A</b>	Strobe Tube	All Voltages	131DST, 131ST, 371DST
<b>K149130A</b>	Strobe Tube	All Voltages	AV1ST, LP3, LP6

## ► Replacement Lamps

### INCANDESCENT LAMPS

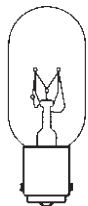

K149123A

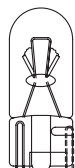

K8107185A

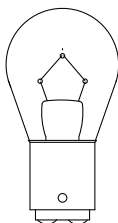

K8107210A

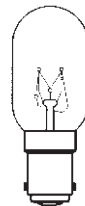

K8107194A



K8107A149A

Part	Description	Voltage	Applicable Models
<b>K149123A</b>	Incandescent Lamp	120V	225, 225X
<b>K8107185A</b>	Incandescent Lamp	All Voltages	MSL
<b>K8107210A</b>	Incandescent Lamp	24V	LSL
<b>K8107194A</b>	Incandescent Lamp	120V	LSL
<b>K8107A149A</b>	Incandescent Lamp	240V	LSL