

## MP Up Light STANDARD PLUS



PROJECT

CATALOG #

TYPE

NOTES

Being the smallest scale Up Light in the FX family, the MP is easy to integrate into any intimate garden space. It is an excellent choice for illuminating small garden elements such as dwarf trees. Its tiny size will hide seamlessly among plants or boulders to keep the lighting source a secret.

### Quick Facts

- Die-cast aluminum construction
- Two layer anodization and superior outdoor TGIC powder-coat finish options
- MR-11 lamp and GU4 base
- ProAim® adjustability
- Compatible with MR-11 lens accessories
- Input voltage: 10 to 15 VAC/VDC
- Phase dimmable

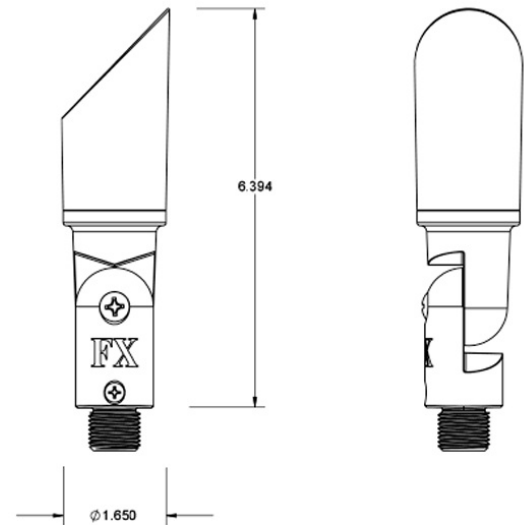



# MP Up Light SPECIFICATIONS

## About FX Luminaire

As a leading manufacturer of landscape and architectural lighting, FX Luminaire provides innovative products, resources, and support to help customers bring their visions to life. The company offers a range of specification-driven solutions, including fixtures, controls, and accessories, to enhance residential and commercial landscapes.

## Materials

Die-cast zinc/aluminum alloy housing, shroud, and knuckle with stainless steel hardware.

## Knuckle

Die-cast zinc/aluminum alloy knuckle with 1/2"-14 (13 mm) NPSM threads. Compress and lock features prevent slip after installation. Offers 9° increments of adjustability over 220° of vertical adjustment.

## LED

GU4 lamp base. Preinstalled options include MR-11 LED lamp.

## Finish

Two-layer protection of sulfuric acid anodization and polyester TGIC powder-coat finish, providing superior outdoor weathering in all conditions. Tested to ASTM standards.

## Hardware

Stainless steel angle lock screw with setscrew. Includes 10" (254 mm) ABS slotted installation spike.

## Wiring

18 AWG (1 mm); SPT-1W; 220°F (105°C); 300 V; 16" (405 mm) length

## Sockets

GU4 socket with retaining clips for MR-11 lamps. Ceramic socket base with heat-resistant contact pad. Stainless steel retaining clips ensure high spring force retention.

## Power

Input 10 to 15 VAC/VDC, 50/60 Hz. Remote transformer required (specify separately).

## Housing

Die-cast zinc/aluminum alloy housing with capacity for one standard MR-11 lamp.

## Glare Control

Die-cast zinc/aluminum alloy shroud with 15° cutoff.

## Weight

1.3 lbs (0.6 kg)

## Lens

Tempered glass lens with shock resistance and high tolerance for thermal expansion and stress.

## Ambient Operating Temperature

0°F to 140°F (-18°C to 60°C)

## Installation Requirements

Designed for installation in the upward direction only.

## Control

Zoning and dimming available with use of Luxor® Technology and Luxor Low-Voltage CUBE (LCM-LV). Luxor Technology allows up to 250 groups, dimmable in 1% increments between 0 and 100%.

## Warranty







10-year limited warranty on fixture; 3-year limited warranty on LED lamp

## Listings



# MP Up Light ORDERING INFORMATION

[field\_spec\_builder\_mount] [field\_spec\_builder\_mount]

| Fixture   | Power   | Finish   |
|-----------|---|--|
| <b>MP</b> | <b>ECO20WFL</b><br>3.3 VA, 2700K, 35° LED MR-11 lamp<br><br>(ECO lamp series) | <b>BZ</b><br>Bronze Metallic  |
|           | <b>ECO20SFL</b><br>3.3 VA, 3000K, 35° LED MR-11 lamp<br><br>(ECO lamp series) | <b>FB</b><br>Black            |
|           | <b>NL</b><br>Lamp not included  | <b>DG</b><br>Desert Granite   |
|           |   | <b>WI</b><br>Weathered Iron   |
|           |   | <b>SB</b><br>Sedona Brown     |
|           |   | <b>FW</b><br>Flat White       |
|           |   | <b>SV</b><br>Silver           |



EXAMPLE FIXTURE CONFIGURATION: MP-ECO20WFL-FB

\* Ships with Super Slot Spike.













## MR11ECO20WFL - Illuminance at a Distance

| Distance      | Center Beam fc     | Beam Width        |
|---------------|--------------------|-------------------|
| Feet (Meters) | Foot-Candles (Lux) | Vertical : 33.9 ° |
| 3.3' (1.0 m)  | 29.7 fc (320 lx)   | 2.0' (0.6 m)      |
| 6.7' (2.0 m)  | 7.2 fc (78 lx)     | 4.1' (1.3 m)      |
| 10.0' (3.0 m) | 3.2 fc (35 lx)     | 6.1' (1.9 m)      |
| 13.3' (4.1 m) | 1.8 fc (19 lx)     | 8.1' (2.5 m)      |
| 16.7' (5.1 m) | 1.2 fc (13 lx)     | 10.2' (3.1 m)     |

## MR11ECO20SFL - Illuminance at a Distance

| Distance      | Center Beam fc     | Beam Width        |
|---------------|--------------------|-------------------|
| Feet (Meters) | Foot-Candles (Lux) | Vertical : 32.6 ° |
| 3.3' (1.0 m)  | 35.5 fc (382 lx)   | 1.9' (0.6 m)      |
| 6.7' (2.0 m)  | 8.6 fc (93 lx)     | 3.9' (1.2 m)      |
| 10.0' (3.0 m) | 3.9 fc (42 lx)     | 5.9' (1.8 m)      |
| 13.3' (4.1 m) | 2.2 fc (24 lx)     | 7.8' (2.4 m)      |
| 16.7' (5.1 m) | 1.4 fc (15 lx)     | 9.8' (3.0 m)      |

MOUNTING OPTIONS: Specify Separately



| Mounts                              | Catalog No.    |   | Mounts                           | Catalog No.  |   |
|-------------------------------------|----------------|---|----------------------------------|--------------|---|
| Long Slot Spike                     | 250015840000   |  | Three-Prong Spike                | 250020020000 |  |
| Lock Ring                           | 250030410000SP |  | Super Slot Spike                 | 753900       |  |
| Gutter Mount                        | GM-SS          |  | Ground Mount with 1/2" Thread    | GM-XX*       |  |
| Mini J-Box for 1/2" Thread          | MJB-050-XX*    |  | ProAim® Ratcheting Spike         | PARS         |  |
| Post Mount                          | PM-XX*         |  | Super J-Box Spike                | SJ-XX*       |  |
| TreeBox® Mount with 1/2" Thread     | TB-XX*         |  | VersaBox® Mount with 1/2" Thread | VB-050-XX*   |  |
| Variable Height Riser for Up Lights | VHR-UL         |  |                                  |              |   |



# MP Up Light ORDERING INFORMATION

GLARE CONTROL: Specify Separately

| Glare Control   | Catalog No.  |   | Glare Control | Catalog No. |
|-----------------|--------------|---|---------------|-------------|
| MR11 Hex Baffle | 250015250000 |  |               |             |

POWER OPTIONS: Specify Separately

| Power   | Catalog No. |   |
|---|-------------|---|
| Luxor CUBE- Low-voltage                       | LCM-LV      |  |
| Step-Down Transformer, UV (120/277 V to 12 V) | ST-UV       |  |

| Power                    | Catalog No. |   |
|--------------------------|-------------|---|
| Plug-In Transformer, 6 W | MT-6W       |  |
| Surge Protection Module  | SURGE-MOD   |  |
| -                        |             |   |