

# INSTRUCTION MANUAL

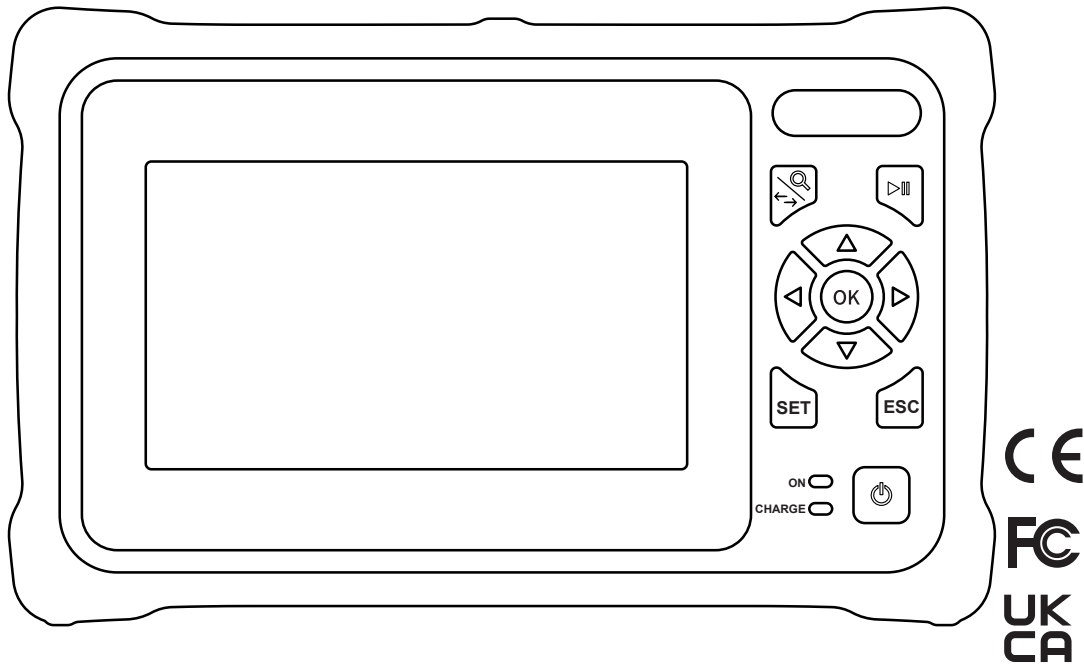

**TEMPO**<sup>®</sup>  
COMMUNICATIONS



## OFL100 OTDR



Read and understand all of the instructions and safety information in this manual before operating or servicing this tool.

Register this product at [www.TempoCom.com](http://www.TempoCom.com)

# Table of Contents

<b>Preface</b>	<b>3</b>
Description .....	3
Safety .....	3
Purpose of This Manual .....	3
Warranty .....	3
<b>Important Safety Information</b>	<b>4</b>
<b>Section 1. Introduction</b>	<b>7</b>
<b>Section 2. Basic OTDR Information</b>	<b>8</b>
Principle of OTDRs .....	8
Basic Definition and Classification of Events .....	8
<b>Section 3. OFL100 Operation</b>	<b>8</b>
Host .....	8
Function Keys .....	9
Main Interface .....	9
Auto OTDR .....	10
Expert OTDR .....	10
Parameter Settings .....	11
OFL100 Pulswidth Selection .....	11
Threshold/Criterion .....	12
Threshold Settings .....	12
Eligibility Criteria .....	12
OFL Trace .....	12
OTDR File Saving .....	13
File Operation .....	13
Event Map .....	14
OPM .....	14
VFL .....	14
Laser Source .....	15
Optical Loss Test .....	15
RJ45 Sequence Testing .....	15
System Settings .....	16
<b>Section 4. OFL100 Troubleshooting</b>	<b>17</b>
<b>Section 5. Trace Viewer</b>	<b>17</b>

# Preface

## Description

The Tempo Communications OFL100 is an Optical Time Domain Reflectometer (OTDR) that is used to measure the length and individual loss events on a singlemode fiber optic link.

## Safety

Safety is essential in the use and maintenance of Tempo Communications tools and equipment.

This instruction manual and any markings on the tool provide information for avoiding hazards and unsafe practices related to the use of this tool. Observe all of the safety information provided.

## Purpose of This Manual

This instruction manual is intended to familiarize all personnel with the safe operation and maintenance procedures for the Tempo Communications OFL100 handheld OTDR.

This instruction manual is free to download from [www.tempocom.com](http://www.tempocom.com)

## Warranty

Tempo Communications Inc. warrants to the original purchaser of these goods for use that these products will be free from defects in workmanship and material for two years. This warranty is subject to the same terms and conditions contained in Tempo Communication's standard one-year limited warranty.

For all Test Instrument repairs, contact Customer Service at 800-642-2155 to request a Return Authorization. For items not covered under warranty (such as items dropped, abused, etc.), a repair cost quote is available upon request.

Note: Prior to returning any test instrument, please check the battery is at full charge.

# Important Safety Information



## SAFETY ALERT SYMBOL

This symbol is used to call your attention to hazards or unsafe practices which could result in an injury or property damage. The signal word, defined below, indicates the severity of the hazard. The message after the signal word provides information for preventing or avoiding the hazard.

### **⚠ DANGER**

Immediate hazards which, if not avoided, **WILL** result in severe injury or death.

### **⚠ WARNING**

Hazards which, if not avoided, **COULD** result in severe injury or death.

### **⚠ CAUTION**

Hazards or unsafe practices which, if not avoided, **MAY** result in injury or property damage.



### **⚠ WARNING**

Read and understand all of the instructions and safety information in this manual before operating or servicing this tool.

Failure to observe this warning could result in severe injury or death.

### **⚠ WARNING**

Electric shock hazard:

- Do not operate in an explosive atmosphere such as in the presence of flammable gases or fumes.
- Before applying power, verify that the unit is set to match the available line voltage.

Failure to observe these warnings could result in severe injury or death.

## Important Safety Information (cont'd)

<b>⚠ WARNING</b>
Connecting the OFL100 to a live fiber may cause permanent damage. <b>Do not connect to live fibers.</b>

<b>⚠ WARNING</b>
Electric shock hazard: <ul style="list-style-type: none"> <li>• Fuse replacement should be performed by Tempo qualified personnel.</li> <li>• Do not use repaired fuses or short-circuited fuse holders.</li> </ul> Failure to observe these warnings could result in severe injury or death.

<b>WARNING</b>
INVISIBLE LASER RADIATION DO NOT VIEW DIRECTLY WITH OPTICAL INSTRUMENTS CLASS 1M LASER PRODUCT IEC 60825-1:2014

	VISIBLE LASER RADIATION AVOID DIRECT EYE EXPOSURE CLASS 2 LASER PRODUCT IEC 60825-1:2014 MAX OUTPUT < 1mW WAVELENGTH 650±20nm PULSE DURATION CW
---	---

While there is no potential for eye damage due to unaided direct exposure, users should always avoid looking directly into the output port. The use of optical viewing instruments, such as microscopes, magnifiers, etc., should always be avoided. The use of such devices around active fibers can focus an intense beam of light energy onto the retina of the eye, which can result in permanent damage.

<b>⚠ CAUTION</b>
Laser hazard: <ul style="list-style-type: none"> <li>• When performing measurements on fiber optic systems, avoid eye exposure to any open-ended fibers, optical connectors, optical interfaces, or other sources because they may be connected to active laser transmitters.</li> <li>• Do not look into the optical port when a source is turned on.</li> <li>• Avoid looking at the free end of a test fiber, i.e., the end not connected to the instrument. If possible, direct the free end toward a non-reflective surface.</li> </ul> Failure to observe these precautions may result in injury.

## Important Safety Information (cont'd)

### **CAUTION**

Electric shock hazard:

- Do not expose batteries to fire or intense heat. Do not open or mutilate batteries. Avoid touching the electrolyte in the batteries, which is corrosive and may cause damage to eyes or skin.
- Do not open the case of the unit for any reason. It contains no user-serviceable parts.
- Use this unit for the manufacturer's intended purpose only, as described in this manual. Any other use can impair the protection provided by the unit.

Failure to observe these precautions may result in injury and may damage the unit.

### **CAUTION**

Instrument damage hazard:

- Make sure that the optical fiber or cable is not in use and there is no laser beam in the fiber before testing with this unit.
- Do not leave the unit in direct sunlight or near direct sources of heat.
- Protect the unit from strong impacts or shock.
- Do not immerse the unit in water or store in areas with high humidity.
- When necessary, clean the case, front panel, and rubber cover with a damp cloth. Do not use abrasives, harsh chemicals, or solvents.
- Replace the protective dust cap when the unit is not in use.
- Store the unit and interface adapters in a cool, dry, and clean place.

Failure to observe these precautions may result in injury and may damage the unit.

### **CAUTION**

Electric shock hazard:

- Do not expose the unit to extremes in temperature or high humidity. Refer to published specifications.
- Turn the unit off, disconnect from power, and make sure the laser source is off before cleaning.

Failure to observe these precautions may result in injury and may damage the unit.

### **CAUTION**

The OFL100 uses a polymer lithium battery and is to be charged with the supplied charger at 5V/2A at a temperature range of 0° to 50°. The OFL100 will not charge.

Do not use any other charger to charge the OFL100.

Do not attempt to change the battery. Please send the OFL100 to our Vista plant or to an Authorized Repair Center.

**⚠ CAUTION****Do not discard this product or throw away!**For recycling information, go to [www.TempoCom.com](http://www.TempoCom.com).

Tempo Communications Inc. hereby declares that the OFL100 is in compliance with the essential requirements and other relevant provisions of Directive 1999/5/EC. A copy of the full Declaration of Conformity may be downloaded from [www.TempoCom.com/support/compliance](http://www.TempoCom.com/support/compliance).

## Section 1. Introduction

Tempo's OFL100 handheld OTDR can measure a single optical fiber or an entire fiber optic link.

The OFL100 can check the transmission quality of optical fiber through the measurement of backscatter. Standard organizations like the International Telecom Union (ITU) define backscatter as an effective analysis means to measure optical fiber loss. Backscattering is also the only effective way of connector inspection, which can be applied to measure the length of optical fiber.

The OFL100 OTDR operates by reviewing events in optical fiber (for example, irregularities and connectors). These tools can help identify irregularities in optical fiber, locate them, and measure their attenuation, relevant loss, and homogeneity.

The OFL100 is easy to use, small, and compact with large touchscreen LCD display with graphical interfaces. They can save and transfer the measurement curves data to a PC by using the provided Trace Viewer software for further analyzing, reporting, and printing.

### Basic applications:

- Measure the length of optical fiber and cable.
- Measure the distance between two points on optical fiber and cable.
- Measure loss between two points on optical fiber and cable.
- Measure fusion splice losses.
- Measure reflection of reflective events of fiber optic links.
- Locate faults of optical fiberoptic cables.
- Display distribution curve of optical fiber and cable loss.

## Section 2. Basic OTDR Information

### Principle of OTDRs

An OTDR (Optical Time Domain Reflectometer) is a measurement instrument for identifying optical fiber transmission features. The OTDR is used to measure the overall attenuation of a fiber optic link and to provide details relating to the position of each event in that link. Events include splices, connectors, bends, and optical components. Its non-destructive, single-ended connection and rapid measurement have made the OTDR an indispensable tool for manufacturing, construction, and maintenance of optical fiber links.

The faults and heterogeneity of optical fiber itself cause Rayleigh scattering of light transmitted in optical fiber. Part of the light pulse is scattered in the reverse direction, and this is called Rayleigh backscattering, which actually provides attenuation details relating to fiber length.

Information relating to distance is obtained through time information (thus “time domain” in the name OTDR). Fresnel reflection occurs at the boundary between two media of different IOR (for example, connections of faults, connectors, or optical fiber end). This reflection is used to locate the discontinuous points on optical fiber. The magnitude of reflection depends on the difference between IOR and the smoothness of boundary.

An OTDR sends out a light pulse into the optical fiber and receives reflections of events and backscattering power of the pulse in time. Locations will be displayed on the LCD. The y-axis is the dB value of backscattering power, and the x-axis is the distance.

### Basic Definition and Classification of Events

Events refer to any abnormal points causing attenuation or sudden change of scattering power besides the normal scattering of optical fiber, which include losses such as bending, connections, and ruptures.

Event points displayed on the LCD are abnormal points that cause traces to deviate from a straight line.

Events can be classified as reflection events or non-reflection events.

## Section 3. OFL100 Operation

### Host

#### Top

- ① OTDR/LS port
- ② OPM port
- ③ VFL port
- ④ Flashlight
- ⑤ LAN 1
- ⑥ LAN 2
- ⑦ SD Card
- ⑧ Type C USB

#### Main View

- ① Dust cover
- ② 4.3 inch color LCD
- ③ Function keys
- ④ Charging indicator
- ⑤ Power on status indicator

#### Bottom

- ① RJ45 Sequence Test Remote

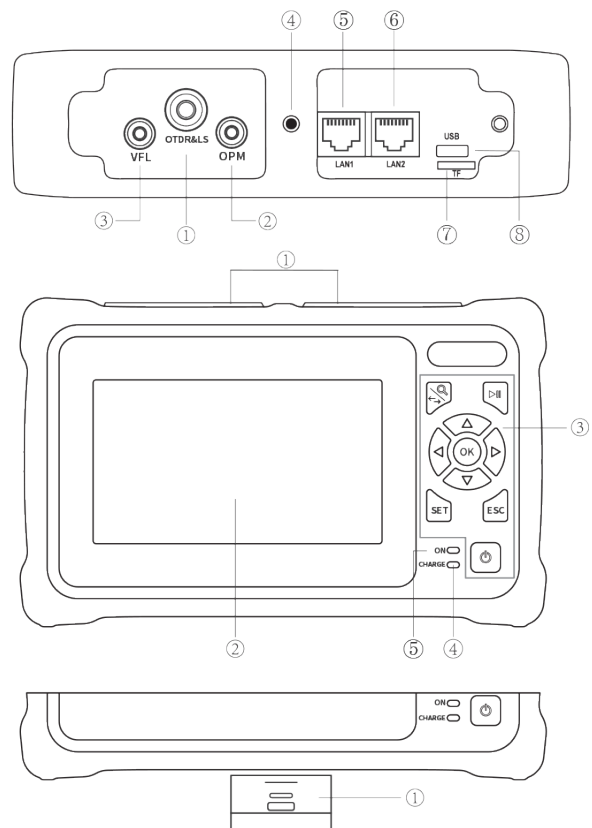

## Function Keys

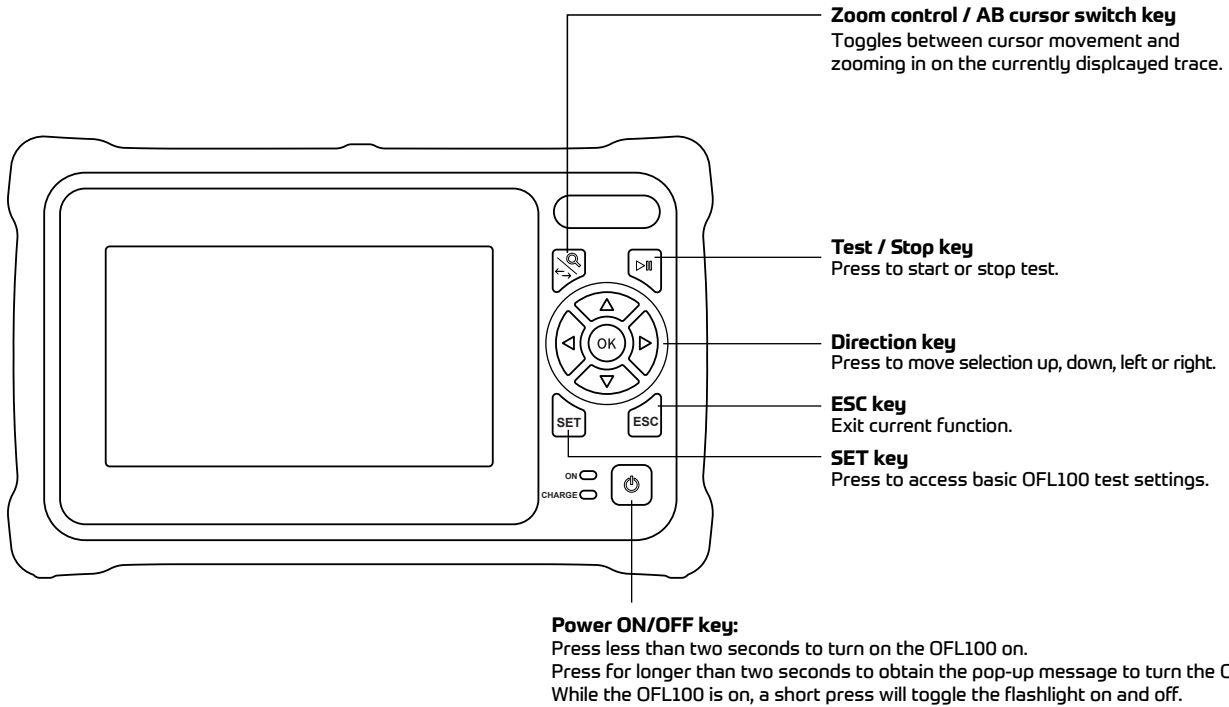

## Main Interface

Use the cursor keys to navigate to the desired function and press OK key to select that function or directly select on the screen.

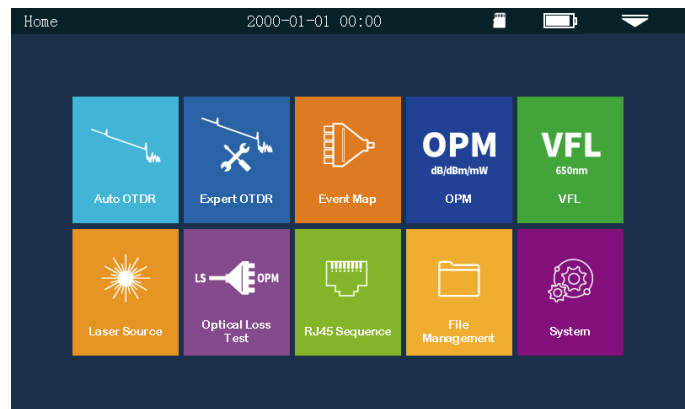
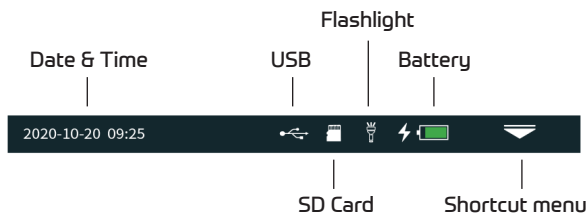

Press the “Shortcut menu” icon to enter the quick operation menu, and press select the desired function.

Press the Print Screen camera icon to make a screen shot. The screen shot is automatically saved with a file name being the current time.

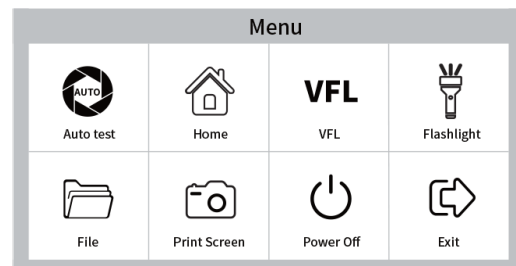

## Live Fiber Warning

If a measurement is attempted and there is live fiber traffic the OFL100 will not start a measurement and display a Live Fiber Warning.

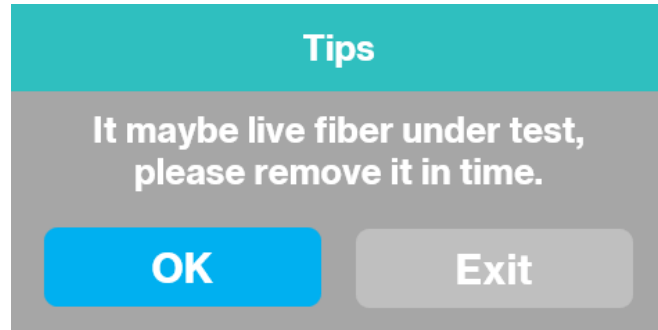

## Auto OTDR

All parameters are automatically determined and the OFL100 will measure the length and attenuation of a fiber optic link.

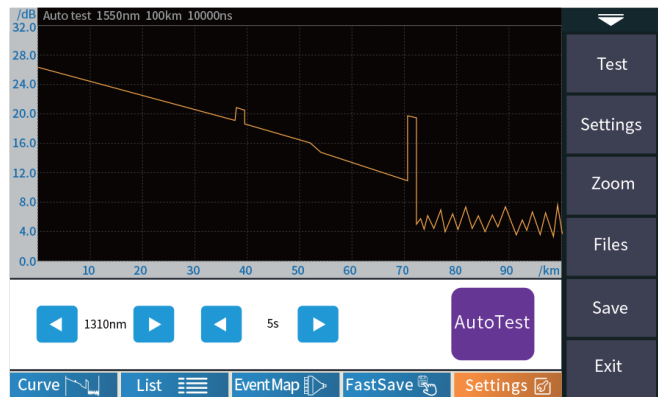

## Expert OTDR

The user can set each test parameter to optimize for the most accurate test result.

- Curve

The trace and event list are displayed at the same time.
- List

Link results are summarized in a list.
- Event Map

Switch to event icon display mode.
- FastSave

Save the current trace file quickly.
- FastSet

Enter parameter setting interface.

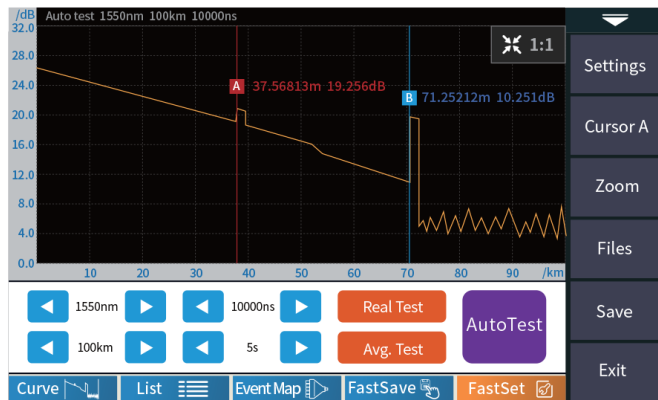

### AutoTest

Perform an automatic test with OFL100 determined settings.

### Real Test

Perform an updated real time test at a rate of approximately 2Hz for real time identification of events.

### Averaging Test

Perform a test with user determined settings with a static display upon completing the measurement.

## Parameter Settings

**Wavelength:** The wavelength can be set to 1310nm or 1550nm.

**Range:** The range can be set to capture the entire fiber link length.

**Pulse width:** Refers to the time width of the optical pulse signal emitted during test. The larger the pulse width, the stronger the optical power injected into the optical fiber, the stronger the backscattering signal of the optical fiber is, and the farther the effective detection distance of the OTDR can be. However, the large pulse width will cause saturation of the initial reflection signal and a longer deadzone. The choice of pulse width is related to the length of the optical fiber. The longer the length, the larger the pulse width, which can only be modified in real-time/average measurement mode.

**IOR:** The Index of Refraction is provided by optical cable fiber manufacturer and can be found on the individual spool of fiber. The technician can enter the IOR for the most accurate measurements.



**Test time:** Used in the average test mode to set the total averaging time. A longer averaging time will result in the best signal to noise ratio.

**Unit:** Used to select the desired units to km/kfeet or miles.

## OFL100 Pulsetwidth Selection

Test range \ Pulse	500m	1km	2km	4km	8km	16km	32km	64km	100km
3ns	✓	-	-	-	-	-	-	-	-
5ns	✓	✓	✓	✓	✓	-	-	-	-
10ns	✓	✓	✓	✓	✓	-	-	-	-
20ns	✓	✓	✓	✓	✓	-	-	-	-
30ns	✓	✓	✓	✓	✓	-	-	-	-
50ns	✓	✓	✓	✓	✓	✓	-	-	-
80ns	✓	✓	✓	✓	✓	✓	✓	-	-
160ns	✓	✓	✓	✓	✓	✓	✓	✓	✓
320ns	-	-	-	✓	✓	✓	✓	✓	✓
500ns	-	-	-	-	✓	✓	✓	✓	✓
800ns	-	-	-	-	-	✓	✓	✓	✓
1000ns	-	-	-	-	-	✓	✓	✓	✓
2000ns	-	-	-	-	-	-	-	✓	✓
3000ns	-	-	-	-	-	-	-	✓	✓
5000ns	-	-	-	-	-	-	-	✓	✓
8000ns	-	-	-	-	-	-	-	✓	✓
10000ns	-	-	-	-	-	-	-	✓	✓
20000ns	-	-	-	-	-	-	-	-	✓

## Threshold/Criterion

### Threshold Settings

**Event loss threshold:** Set the loss threshold for connectors and fusion splices between 0.2 and 30dB. The default is 0.2dB. Events larger than the threshold will be listed in the event table.

**Reflection threshold:** Set the return loss threshold for reflective events ranging between 10dB and 60dB. The default is 40dB. Reflective events more intense than 40dB will be recorded in the event table.

**End threshold:** The end of the fiber link will be determined by the end threshold setting. The range can be adjusted from 1 to 30dB with the default set to 10dB. The first loss event >10dB will indicate the end of the fiber.

### Eligibility Criteria

Setting the threshold determines the pass or fail criteria for each event.

**Fresnel events:** Reflective events typical of connectors.

**Raleigh events:** Non reflective events typical of fusion splices.

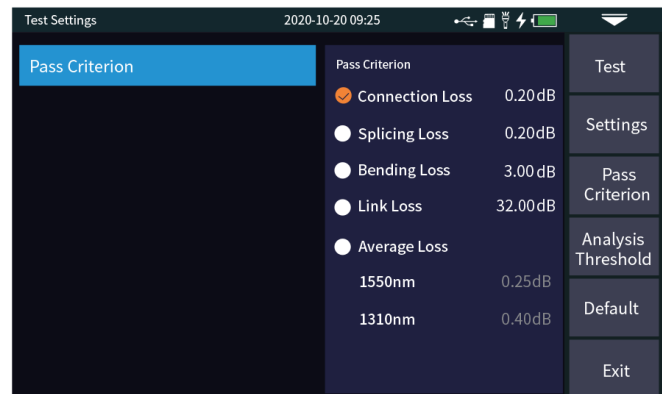
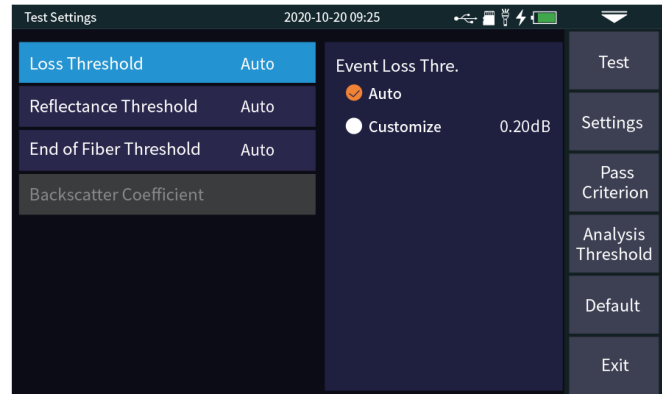

## OFL100 Trace

Select correct parameter, the test results such as trace and event list will be displayed after test completed.

### Curve Zoom:

Press the [zoom] menu to enter the zoom in and zoom out mode.

◀/▶ Zoom in or out in X direction

▲/▼ Zoom in or out in Y direction

### Event List

**Total length:** The total length of the link under test.

**Total loss:** The total loss of the link under test.

**Average Loss:** The loss per kilometer of the link under test.

**Total events:** The total number of events, the number of passed events and the number of failed events of the link under test.

**NO.:** The order of the current event.

**Type:** The type of the current event.

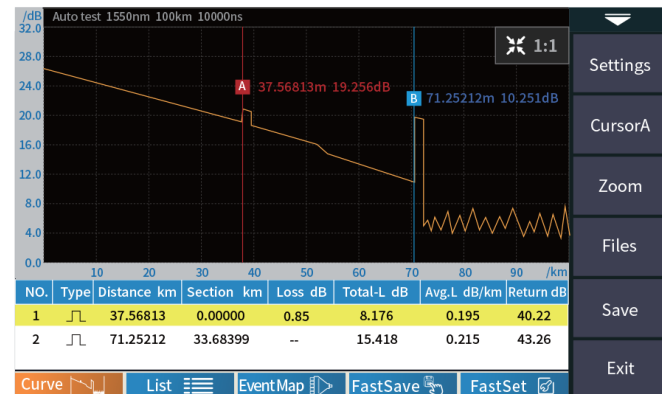

**Distance:** The location of the current event.

**Segment Section:** the distance between the previous event and the current event.

**Loss:** the loss of the current event.

**Reflectivity:** the return loss of the current event.

## OTDR File Saving

After the measurement, press [save] to save the file, enter the file name using the pop up keypad, and press [enter] to save the file. You can also press [Fastsave] to save the file. The file is saved in a folder named the same day's date.

Auto save: open the auto save function, the file name will be automatically generated according to the rules; **File naming method** (only valid for "auto save" and "one click save"):

- ① + ④ : file name + fiber number naming, fiber number
- ① + ② + ④ : file name + wavelength + fiber number naming, fiber number increasing in order;
- ① + ② + ③ + ④ : file name + wavelength + pulse width + fiber number, and the fiber number increases in order.  
File name: enter the file name manually;

**Optical Fiber Code ID:** The optical fiber number and code set when the line is installed:

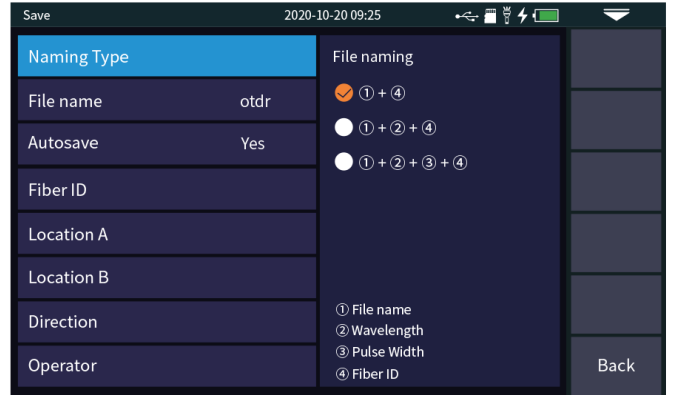

**Location A:** Link start point location

**Location B:** Link termination point location

**Direction:** Optical fiber test direction, from A to B, from B to A;

**Operator:** Enter the name of the technician.

## File Operation

### File Operation

All the test curves are saved in the standard SD card of the instrument. Press [File] to enter the file operation interface. You can open, delete and rename files.

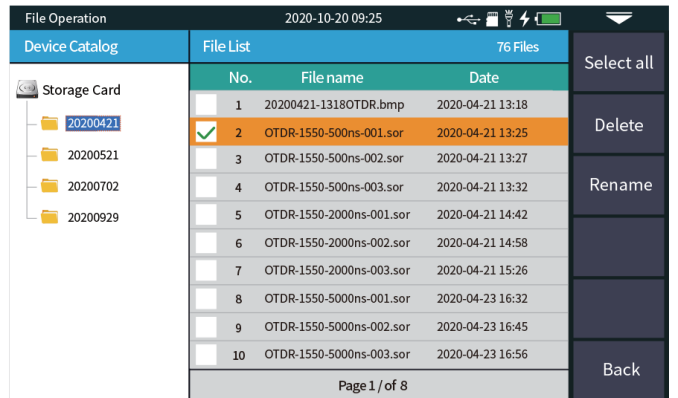

## Event Map

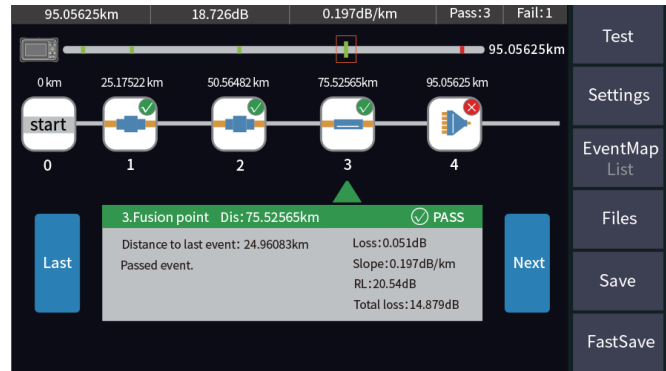
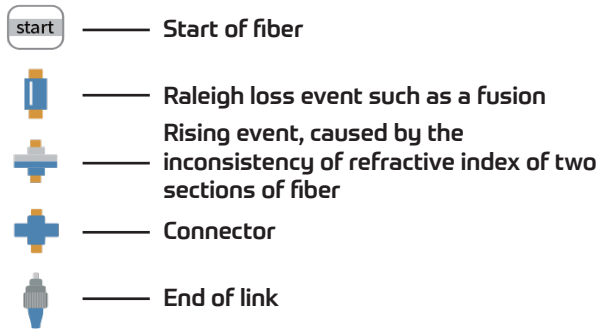

## OPM

The OPM can be used to measure absolute and relative power. The OPM can identify and measure tone wavelengths of 270Hz/330Hz/1kHz and 2kHz emitted from a compatible laser.

- Wavelength:** Set the desired wavelength.
- Reference:** Set the current power as the reference. The Relative power will be set to 0dB where loss measurements can be made.
- Threshold:** Set the threshold value of power measurement. If it exceeds the threshold value, it will be displayed in red; if it is lower than the threshold value, it will be displayed in green.

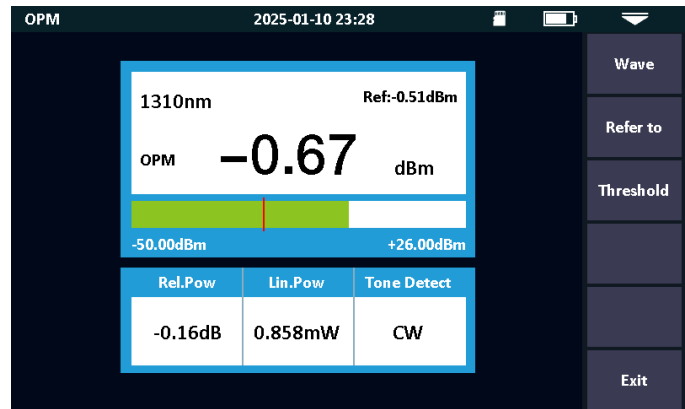

## VFL

The visual fault locator is used to inject red laser light into the fiber under test to allow the technician to visually locate breaks or Macrobends in fiber optic cables. The VFL can also locate contaminated and damaged connectors.

- Open:** Turns the visual fault locator on in continuous wave mode.
- 1Hz:** Visual fault locator flashes at a rate of 1Hz.
- 2Hz:** Visual fault locator flashes at a rate of 2Hz.
- Close:** Turn off visual fault locator.

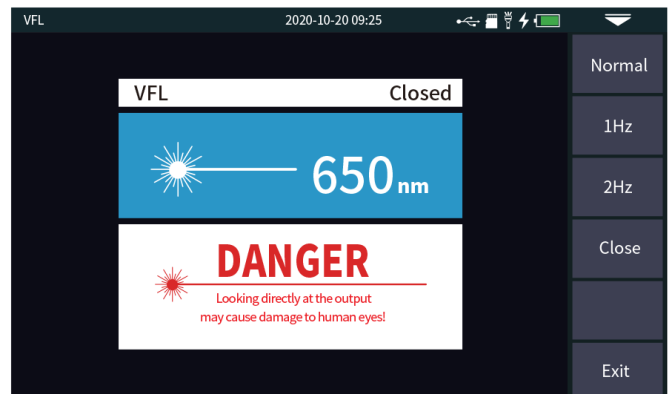

**WARNING**

**Avoid looking directly at the laser output port; permanent eye damage may occur**

## Laser Source

The OFL100 provides a CW stabilized light source that is 1310nm or 1550nm. These can be used with a compatible OPM to measure insertion loss of fiber optic links. A tone can be inserted at 270Hz/330Hz, 1kHz and 2kHz to aid in fiber identification.

**Open:** Turns the laser source on.

**Wavelength:** Allows the technician to set the wavelength of laser source.

**Mode:** Set the laser frequency between CW, 270Hz, 330Hz, 1kHz and 2kHz.

**Power + :** Increase the output power.

**Power - :** Reduce the output power.

The slider bar at the bottom of the screen can be used to adjust the output power.

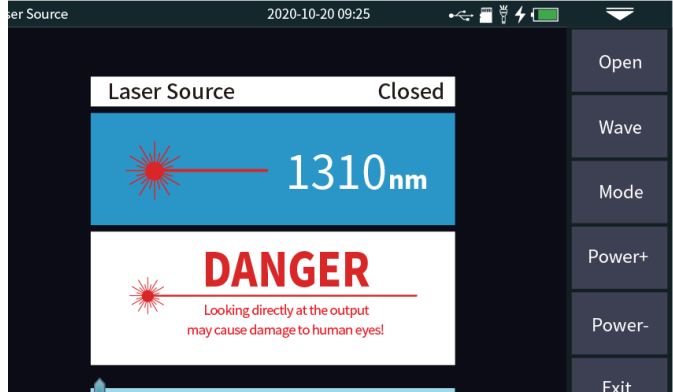

**WARNING**

Avoid looking directly at the laser output port; permanent eye damage may occur

## Optical Loss Test

The optical loss test allows the technician to measure the insertion loss of passive optical components.

To measure insertion loss:

- 1) Set the OPM and SLS to the desired wavelength.
- 2) Connect the SLS (OTDR) port to the OPM port.
- 3) Press Reference. The Rel Pow should be 0dB.
- 4) Insert device to be measured.
- 5) Read the loss of the device under test under Rel Pow.

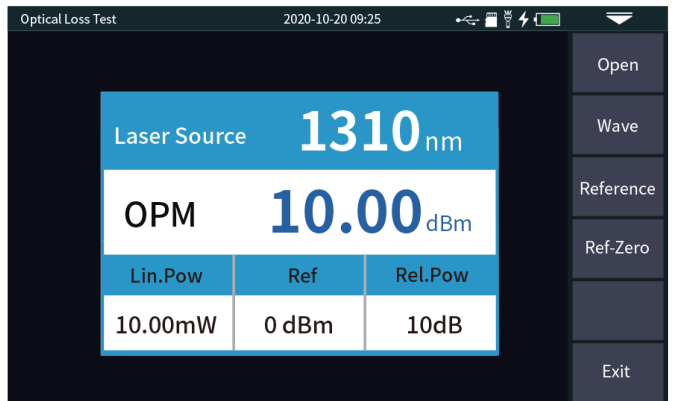

## RJ45 Sequence Testing

Connect the cable under test to LAN2 port and the other end to the remote socket on the bottom of the instrument. Straight connect and Interleaved type cables can be tested.

**Direct Cable Test:** The indicators of the host and remote will flash one at a time from 1 to 8.

**Interleaved Cable Test:** The indicators of the host and the remote will flash one at a time in this order; 3, 6, 1, 4, 5, 2, 7, 8.

Both T568A and T568B cables can be tested.

Do not connect live cables to the OFL100. Doing so may result in permanent damage.

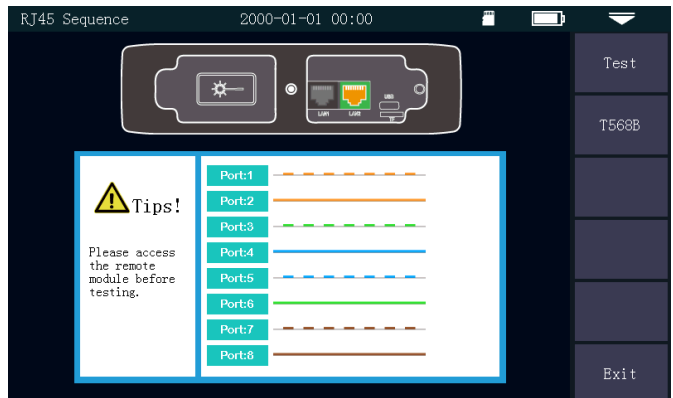

## System Settings

**Automatic shutdown:** The technician can select the desired time to automatically turn the OFL100 off after a period of inactivity equal to 5/15/30/45/60 minutes or to never shut down.

**Backlight brightness:** The technician can adjust the brightness to 20%/40%/60%/80% or 100%.

**Beeper:** The technician can enable or disable the beeper for touch confirmation.

**Language:** Allows the technician to select the desired language.

**USB connection:** Allows the technician to connect and transfer data via the USB port.

**Time & date:** Allows the technician to set the time and date.

**Restore factory settings:** Allows the technician to restore the OFL100 back to factory default.

**Upgrade:** Provides the technician the utility to update the firmware application.

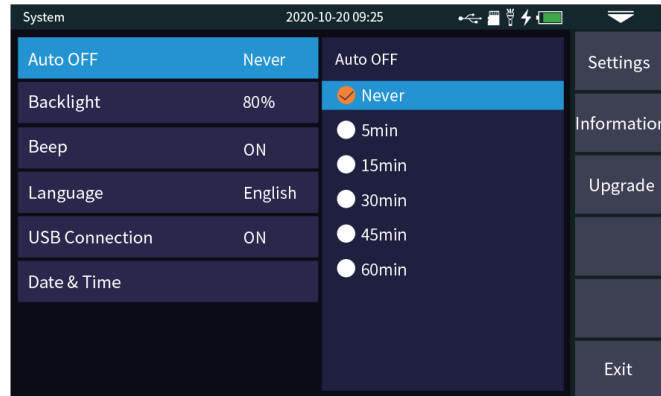

## Section 4. OFL100 Troubleshooting

Fault Description	Cause of Failure	Solution
OTDR will not turn on.	The battery is dead.	Charge the battery and observe the charging indicator. If the red light is displayed, continue charging.
OTDR cannot be charged normally.	Ambient temperature not within acceptable levels.	Replace charger. Try charging the OFL100 with the USB port.
	Check that the charger is working.	Set range to greater than the length of the fiber.
OTDR does not measure and display test results.	OTDR parameters are not set correctly.	Set range to greater than the length of the fiber.
	OTDR bulkhead is contaminated.	Clean OTDR bulkhead and field fiber ferrule.
	OTDR bulkhead is damaged.	Send to Vista for bulkhead repair.
	Optical output connector mismatch.	Use correct fiber size and connector to match bulkhead.
The noise of test curve is excessive, and the waveform is not smooth.	The field fiber is not connected properly to the bulkhead.	Clean and reconnect the field fiber to the bulkhead.
	The pulse width setting is too small.	Increase the test pulse width.
	Averaging time is set too low.	Increase the averaging time.
Events are saturated.	The pulse width is too long.	Decrease test pulse width.
	The last connector is open and likely a flat polished connector.	Terminate the last connector or place a Mandrel wrap on the fiber before the last connector.
After a reflective event there is a long tail.	OTDR bulkhead is contaminated.	Clean OTDR bulkhead and field fiber ferrule.
	OTDR bulkhead is damaged.	Send to Vista for bulkhead repair.
The reflection peak at the end of the fiber cannot be measured.	OTDR parameters are not set correctly.	Set range to greater than the length of the fiber.
	The pulse width is too short.	Increase the test pulse width.
False positive in curve analysis.	Event threshold setting is too low.	Increase the threshold analysis setting.

## Section 5. Trace Viewer

Trace Viewer software is an application developed for the OFL100 OTDR. It allows the previously stored SOR measurement records in the instrument to be uploaded to a PC via the USB port.

The measurements can then be displayed, saved, or printed as a PDF for close out reporting.

The Trace Viewer Documents:

- Fiber trace
- Test conditions/settings
- Fiber information
- File name/date













All events are listed with test results documented in tabular form.

Features of a trace can be zoomed in on and cursors manipulated for closer examination.

# Operating Instructions of the Trace Viewer

Menu		Description
File	Print	Prints the currently open trace file
	Export PDF	Generates a PDF report from the current trace file
	Bat Print	Process multiple trace files at once
	SOR Format	Converts otdr format files into sor format files
Event Analyse Operation	Set Analysis Thresholds	Set loss threshold, reflective loss threshold and end loss threshold
Fiber Information		The optical cable number, optical cable code, optical fiber number, start/end position, operator, equipment name, test date, launch/receive optical fiber and other information of the trace can be modified.
Interface Settings	Unit Select	Set the unit of optical fiber length: km, kft, mi
	Mark-Line Settings	Current location: the location of the cursor is in the original trace; Event location: the cursor switches to the start and end event positions.
Language		Change language

## Icon description

Icon	Instructions
	Open sor file
	Save sor file
	Horizontal enlargement and reduction of curve
	Vertical enlargement and reduction of curve
	Curve initialization
	Move the current cursor left and right
	Move curve up and down
	Switch A and B cursors
	Toggle curve
	Analysis curve
	Add and delete events
	Modify the current event

# Curve output form

Number of files	Output form	Required conditions
Single/multiple curve files	Paper report	Connect the computer to the printer
	Electronic report	NA

## Single curve printing

### 1) Open curve

Mode 1: Directly drag the curve file to the curve display area;  
 Mode 2: Click [File - Open File] or , and select the file to print.

### 2) Generate report

a) If the curve information needs to be modified: click [Fiber Information], modify the corresponding information, click [File - Print], select a printer and print the paper report.

b) If there is no need to modify the information: directly click [File - Print], select the printer and print the paper report.

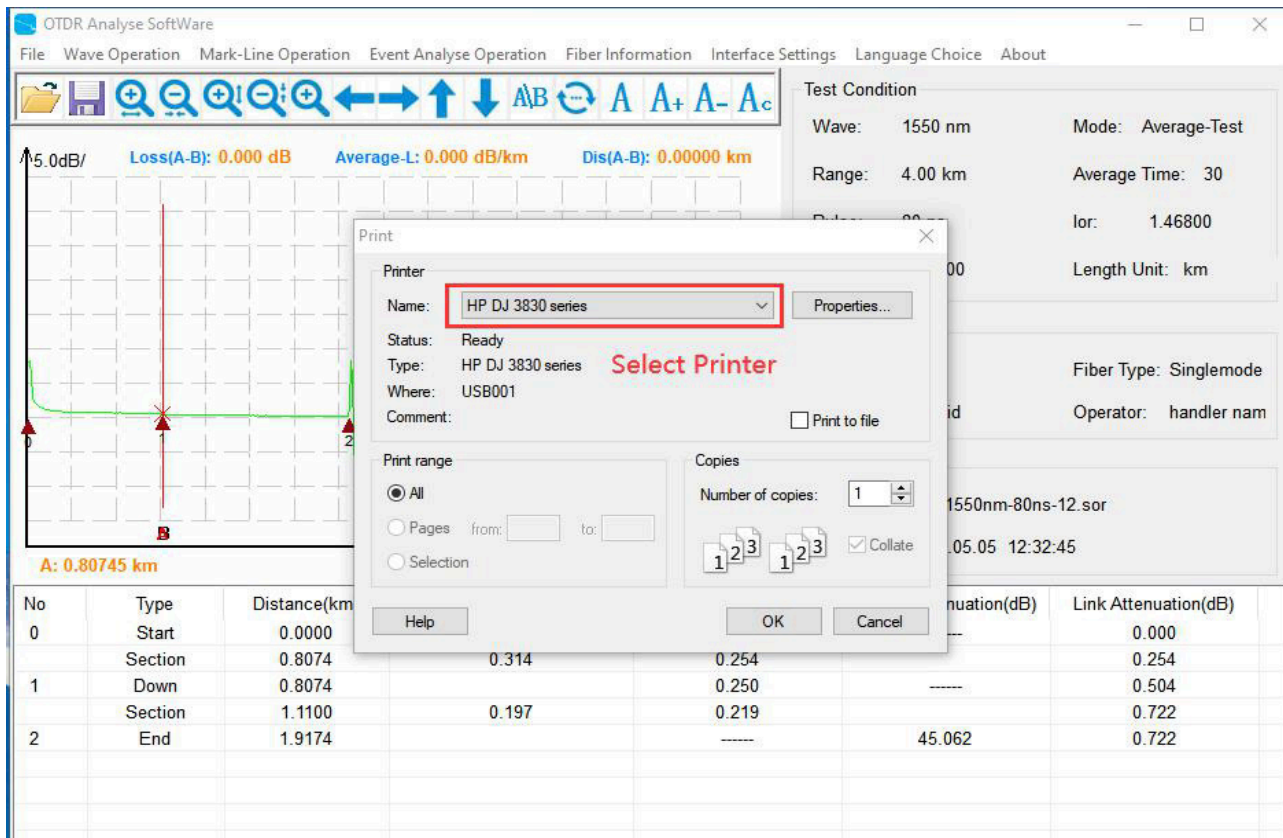

The screenshot shows the OTDR Analyse SoftWare interface. The main window displays a curve plot with a green line and a red vertical line. The plot shows Loss(A-B) as 0.000 dB, Average-L as 0.000 dB/km, and Dis(A-B) as 0.00000 km. A 'Print' dialog box is open, showing the printer selection process. The printer name is 'HP DJ 3830 series'. The dialog also shows the print range (All) and the number of copies (1). The background window shows test conditions: Wave: 1550 nm, Mode: Average-Test, Range: 4.00 km, Average Time: 30, Location: 1.46800, Length Unit: km, Fiber Type: Singlemode, Operator: handler nam.

No	Type	Distance(km)	Loss(dB)	Link Attenuation(dB)
0	Start	0.0000		0.000
	Section	0.8074	0.314	0.254
1	Down	0.8074		0.250
	Section	1.1100	0.197	0.219
2	End	1.9174		45.062

c) Generate PDF electronic report: directly click [File - Export PDF], select the save path, enter the name of the generated file, and click [Save] to generate the electronic PDF report.

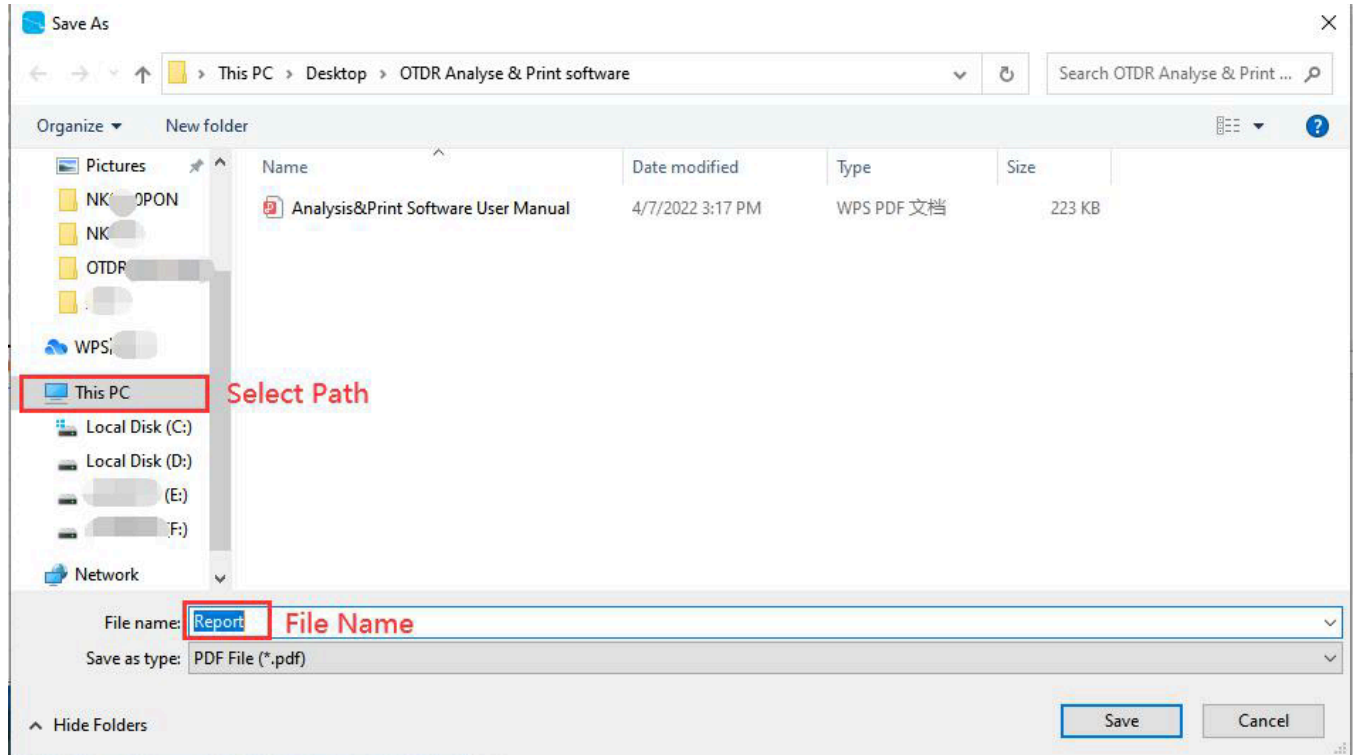

## Multiple curve printing

1) Open curve: click [File - BatPrint], select the target folder, and display all the files in the folder; To add files to the area to be printed.

- Mode 1: Double click the file;
- Mode 2: Select a file, press and hold the “Shift” key, and then select another file. You can select multiple files at the same time;
- Mode 3: Click [Select All] to load all files.

2) Print type: Each page of report can generate 1, 2, 4, 6 or 8 trace files (the more copies per page, will result in less content being displayed).

3) Generate report: click Print and select a printer to print the paper report; Click [Export PDF], select the save path, enter the generated file name, and click [Save] to generate an electronic PDF report.

Bat Print

File Path: 1-6# test data

File Type: sor

No	File Name	Date
1	otdr12_10.sor	2021.05.04 16:11:03
2	otdr12_2.sor	2021.05.04 16:02:53
3	otdr12_3.sor	2021.05.04 16:03:22
4	otdr12_6.sor	2021.05.04 16:05:02
5	otdr12_7.sor	2021.05.04 16:08:26

Source data files

No	File Name	Date
1	otdr12_10.sor	2021.05.04 16:11:03
2	otdr12_2.sor	2021.05.04 16:02:53
3	otdr12_3.sor	2021.05.04 16:03:22
4	otdr12_6.sor	2021.05.04 16:05:02
5	otdr12_7.sor	2021.05.04 16:08:26

Files to be printed

Destination folder

Preview:

Curve preview



Wave: 1550 nm  
 Range: 1.00 km  
 Pulse: 50 ns  
 Av. Time: 5  
 Ior: 1.46800

Print Type: four waves(horizon) on the p:

Preview  
Print  
OutPut PDF

The Tempo Communications Trace Viewer is available for download at [www.tempocom.com](http://www.tempocom.com).

**Tempo Communications**

1390 Aspen Way • Vista, CA 92081 • USA  
 800-642-2155 • An ISO 9001 Company

Tempo Europe Ltd. • Brecon House • William  
 Brown Close Cwmbran • NP44 3AB, UK • Tel: +44  
 1633 927 050

[www.TempoCom.com](http://www.TempoCom.com)