

2019.09.02

# 1RU PREMIUM PATCH PANEL V2



P/N: FPP-03-R1-03



\* Can be purchased FULLY LOADED as pictured



**Non-captive Mounting Ears** - Preinstall screws in rack, simply place rack on screws and tighten.



**Nylon Fiber Manager Loops** - Additional locations for more cable management options. Strong nylon construction with smooth rounded corners. Stress free fiber entry. Snaps into place securely, no screws. Includes 10.



**Optional Locking Kit (FPP-LOCK-KIT)** - Kit includes locks for front and rear. Easy to add and place key kit in knockouts.



**E-Z Slide™ Tray Latch** - Slides out without snags. No push/pull mechanism in the way.

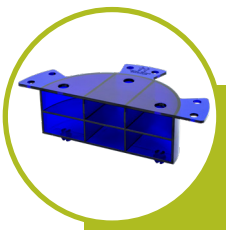

**NEW Blue Half-moon Cable Managers (FPP-CBL-MGR-KIT)** - No screws, snaps into place, stackable (first in industry). Includes 2.

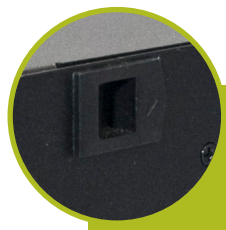

**Easy Release Latches** - Allow you to quickly open panel doors even in a crowded rack.

\* All LEXAN™ SABIC Global product names are trademarks or registered trademarks of SABIC Global

## MORE FEATURES





- Hinged front and rear doors
- Tinted LEXAN™ front cover
- Removable top panel and front faceplate
- Non-captive side and rear entries for trunks
- Standard 19" - 23" rack mountable unit

## SPECIFICATIONS





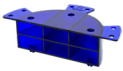
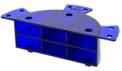
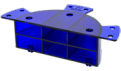
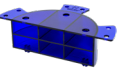

- Dimensions: standard 1RU height x 19" W x 14" D
- Material: 16AWG steel
- Coating: electrostatic polyester powder coat black paint

## WHAT'S INCLUDED

- 2 blue half-moon cable managers
- 4 pressure sensitive Velcro® wire mgmt. straps
- 1 ground lug kit
- 1 Velcro® splice tray tie down (2 meters)
- 10 nylon Fiber Manager Loops
- Mounting hardware: M6 screws, M6 cage nuts
- 4 zip ties
- Port identification label

TRU Premium Patch Panel	MAX. FIBER COUNT		ADAPTER PANEL CAPACITY	SPLICE TRAY CAPACITY					
	LC	SC/ST	LGX	Plastic		Metal			
									
72	36	3		ST-PA-12 2	ST-PA-24 * can screw down 2	ST-M-12 3	ST-M-24 3	ST-M-24-8 3	ST-M-36 2
							N/A		N/A

## Premium Patch Panel Sliding Tray

-  Nylon Fiber Manager Loops
-  E-Z Slide™ Tray Latch
-  Blue Half-moon Cable Managers
-  Velcro® Tie Downs
-  Screw Down Holes for Splice Tray ST-PA-24
-  8mm Additional Space Behind Bulkhead

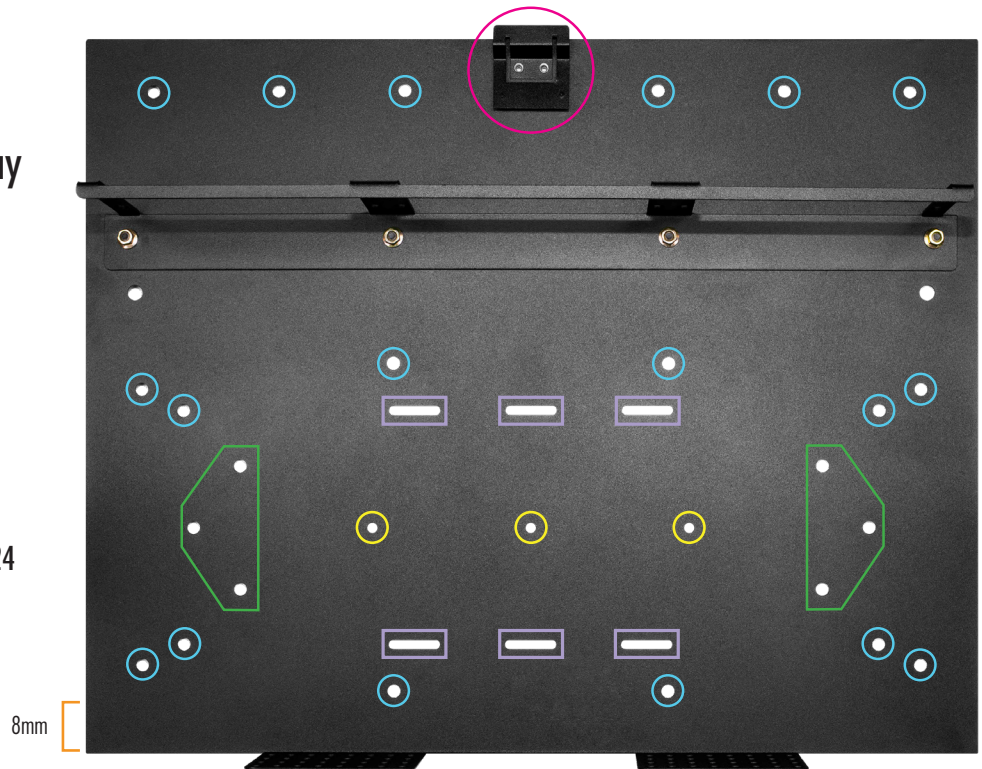

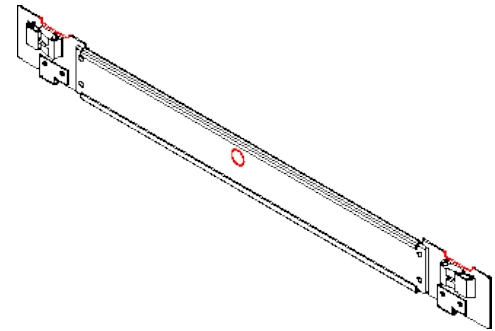
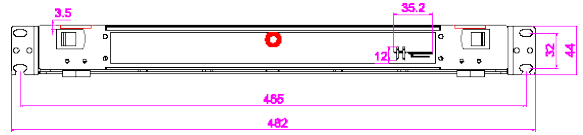
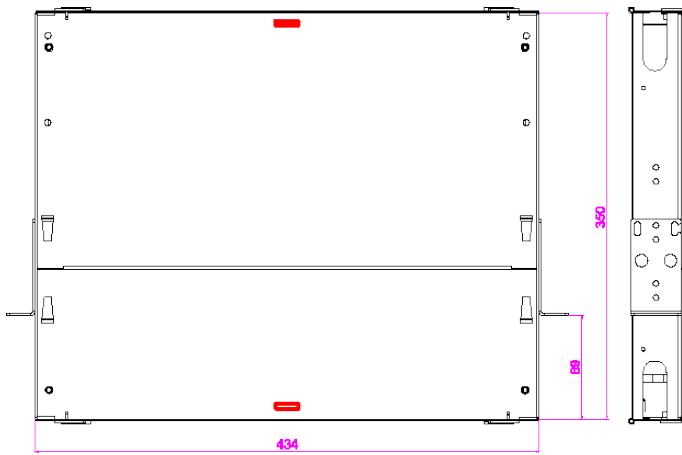

FRONT

HINGED REMOVABLE FRONT AND REAR COVERS

TINTED LEXAN FRONT COVER

Fragile hole

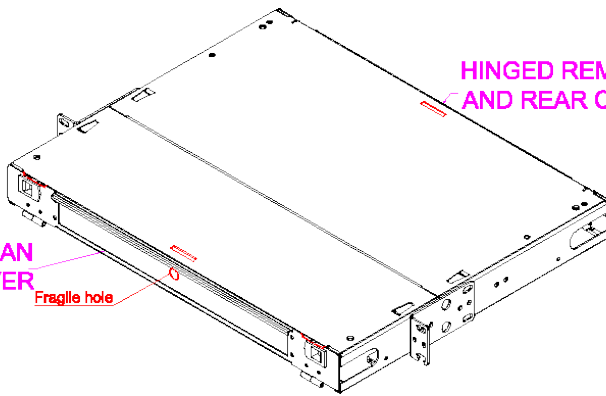

Secure splice trays with Velcro® (included)

2X STRAIN RELIEF GRID

E-Z Slide™ Tray Latch

Front side cable management included

19" - 23" Mounting ear; 19" non-captive

