

Cora™ CG-51 Ground Wash



PROJECT

CATALOG #

TYPE

NOTES

The rugged CG-51 Ground Wash simplifies installation and broadens design options with its threaded top and interchangeable 180° and 360° faceplates. Whether you're upgrading a system or starting fresh, this premium select brass fixture offers straightforward installation, versatile performance, and long-lasting durability in one compact package.

Quick Facts

- IP66/67 rating ensures superior water and dust protection
- Works with standard 2½" Schedule 40 conduit for faster installs
- Open 180° faceplate design eliminates the center brace for pure, unobstructed output
- Interchangeable 180° and 360° faceplates allow precise beam control with fewer SKUs
- Threaded-top design eliminates exposed screws for a clean look
- Low-profile design is ideal for walkways and hardscapes
- Select brass construction offers durability and corrosion resistance

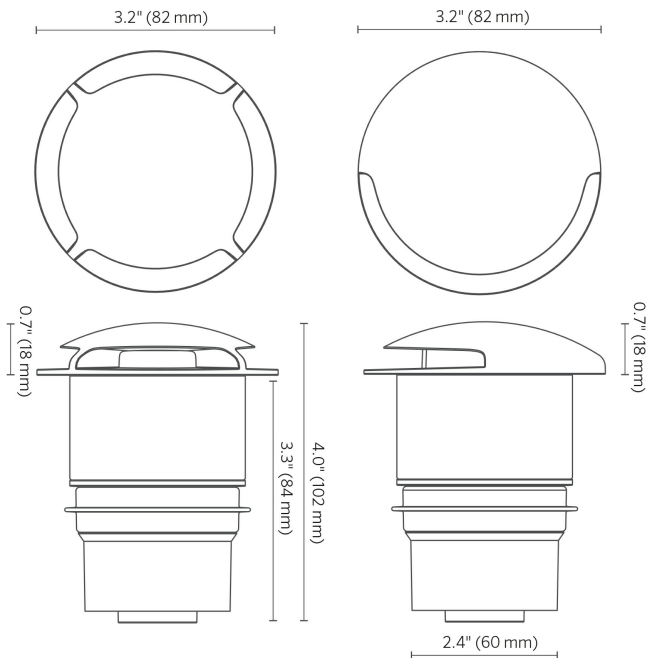

Cora™ CG-51 Ground Wash SPECIFICATIONS

Light Source	E6WFL		E9WFL		P4SFL		P6SFL		ZD5SWF	
	180°	360°	180°	360°	180°	360°	180°	360°	180°	360°
Total Lumens	8	16	10	20	5	10	8	16	7	14
Power Consumption (VA)	6	6	8.5	8.5	4.3	4.3	6.5	6.5	5.4	5.4
Efficacy (lm/W)	2	4	1.8	3.5	1.5	3	2	4	2	4
Maximum Candela (cd)	5	6.5	6.8	7.5	3.7	4.5	7.2	8.2	6.9	5.5
Color Rendering Index (CRI)	85+	85+	85+	85+	85+	85+	85+	85+	85+	85+
Input Voltage (V)	10 to 15	10 to 15	10 to 15	10 to 15	10 to 15	10 to 15	10 to 15	10 to 15	10 to 15	10 to 15
Rated Life (L70)	30,000 hrs	30,000 hrs	30,000 hrs	30,000 hrs	40,000 hrs	40,000 hrs	40,000 hrs	40,000 hrs	40,000 hrs	40,000 hrs

Cora™ CG-51 Ground Wash SPECIFICATIONS

About FX Luminaire

As a leading manufacturer of landscape and architectural lighting, FX Luminaire provides innovative products, resources, and support to help customers bring their visions to life. The company offers a range of specification-driven solutions, including fixtures, controls, and accessories, to enhance residential and commercial landscapes.

Materials

Brass fixture with black oxide stainless steel hardware

Dimming

Primary: Consult transformer specifications. Secondary: Luxor® control (with MR-16 ZD LED Lamp) or a trailing-edge (reverse phase-cut) dimmer

Adjustability

Fixed

Finish

Antique Bronze finish sealed with a clear TGIC powder-coated layer or a black polyester TGIC powder-coated layer, providing superior outdoor weathering in all conditions. Tested to ASTM standards.

Wiring

18 AWG (1 mm); SPT-1W; 220°F (105°C); 300 V; 10' (3 m) length, measured from the light aperture

Sockets

MR-16 GU5.3 socket with retaining clips. Ceramic socket base with heat-resistant contact pad. Stainless steel retaining clips ensure high spring force retention.

Weight

1.6 lb (0.7 kg)

Installation Accessories (Included)

None; purchase conduit separately.

Ambient Operating Temperature

0°F to 140°F (-18°C to 60°C)

Input Voltage

10 to 15 VAC/VDC, 50/60 Hz. Remote transformer required (specify separately).

Power Consumption

Specified power consumption indicates the full apparent power.

Housing Capacity

Designed to accept standard MR-16 Lamps conforming to ANSI C78.24 specifications.

Installation Requirements

Designed for installation in in-grade (upward) or recessed, wall-mounted applications.

Lens Transparency

Frosted

Beam Angles

Varies according to lamp selection

Core Drilling

Recommended core drill size: 2 1/2"

Manufacturing

ISO 9001:2015 certified facility

Lifetime

L70 rating conforms to IES LM-80/TM-21 standards, projecting lumen maintenance to 70% of initial output.

Bug Rating

B0-U1-G0

Warranty

Fixture: Limited 10-year warranty
Included Lamp: Limited 3- or 5-year warranty

Listings



Cora™ CG-51 Ground Wash ORDERING INFORMATION

Fixture	Power	Color Temp	Beam Angle	Faceplate	Wire Lead	Finish
CG-51	E6 6.0 VA, MR-16 Eco LED Lamp					
	E9 8.5 VA, MR-16 Eco LED Lamp					
	P4 4.3 VA, MR-16 Pro LED Lamp	W Warm (2700K)	FL Flood (35°)	180 Ground Wash 180°	[default] 10' (3 m)	FB Black 
	P6 6.5 VA, MR-16 Pro LED Lamp	S Soft (3000K)	WF Wide Flood (60°)	360 Ground Wash 360°	XL 26' (8 m)	AB Antique Bronze 
	ZD5 5.4 VA, MR-16 ZD LED Lamp					
	NL Lamp not included					

- - - - - -









EXAMPLE FIXTURE CONFIGURATION: *CG-51-XX-XXXX-XX*

Cora™ CG-51 Ground Wash ORDERING INFORMATION













GLARE CONTROL: Specify Separately

Glare Control	Catalog No.		Glare Control	Catalog No.	
Hex Baffle for MR-16 LED Lamps	250015260000		RecessorRing® Spacer for MR-16 LED Lamps	RR-MR-16	



LENS OPTIONS: Specify Separately

Lenses	Catalog No.		Lenses	Catalog No.	
MR-16 Linear Spread Lens	250013550000		MR-16 Frosted Lens LED Lamps	250015170000	
MR-16 Foliage-Enhancing Green Dichroic Lens	250015180000		MR-16 Color-Cooling Lens, +600K Shift	250015190000	
MR-16 Color-Softening Lens, +100K Shift	250015200000		MR-16 Green Light Dichroic Lens	250015210000	
MR-16 Red Light Dichroic Lens	250015220000		MR-16 Color-Warming Lens, -200K Shift	250015230000	
MR-16 Solite Spread Lens	250015240000				

POWER OPTIONS: Specify Separately

Power	Catalog No.		Power	Catalog No.	
Low-Voltage Dimmer	DIM-LV		DX Controller, 150 W, Matte Gray	DX-150-M	
DX Controller, 150 W, Stainless Steel	DX-150-SS		DX Controller, 300 W, Matte Gray	DX-300-M	
Luxor Low-Voltage CUBE	LCM-LV		Mini Plug-In Transformer, 30 W	MT-30W	
Plug-In Transformer, 6 W	MT-6W		PX Transformer, 300 W	PX-300-SS	
PX Transformer, 600 W	PX-600-SS		PX Transformer, 900 W	PX-900-SS	
Step-Down Transformer, Dimmable (120 V to 12 V)	ST-120-DIM		Step-Down Transformer, UV (120/277 V to 12 V)	ST-UV	
Surge Protection Module-	SURGE-MOD				

SPLICING OPTIONS: Specify Separately

Splicing	Catalog No.	
Brass Lug Wire Connectors, 2-pack	WCHSBS2	
Heat Shrink Wire Connectors, 20-pack, Medium	WCHSMD20	
Ratcheting Crimper Tool	WCHSTOOL	

Splicing	Catalog No.	
Brass Lug Wire Connectors, 50-item Bulk Pack	WCHSBS50	
Heat Shrink Wire Connectors, 20-pack, Small	WCHSSM20	