

# SAMSUNG Interactive Display

## User Manual

---

WA65F WA75F WA86F

---

The colour and the appearance may differ depending on the product, and the content in the manual is subject to change without prior notice to improve the performance.

Recommended hours of use per day of this product is under 12 hours. If the product is used for longer than 12 hours a day, the warranty may be void.

---

[For India Only]

This product is RoHS compliant.

For more information on safe disposal and recycling visit our website [www.samsung.com/in](http://www.samsung.com/in) or contact our Helpline numbers -

1800 40 SAMSUNG (1800 40 7267864) (Toll-Free)

1800 5 SAMSUNG (1800 5 7267864) (Toll-Free)

© Samsung

Samsung owns the copyright for this manual. Use or reproduction of this manual in parts or entirety without the authorization of Samsung is prohibited.

Trademarks other than Samsung are property of their respective owners.

---

# Table of contents

## Before using the product

Safety precautions	4
Safety symbols	4
Storage	5
Electricity and safety	5
Installation	5
Operation	6
Precautions for use	8

## Preparations

Checking the components	9
Parts	10
Ports	11
Tray	12
Before installing the product (Installation guide)	13
Installing the wall mount	14
Using the wall mount kit	14
Wall mount kit specifications (VESA)	15
Connecting to a network	16
Network settings (Wired)	16
Network settings (Wireless)	18

## Writing

Whiteboard - Entry	20
Pen	20
Pen Mode	21
Screen elements	21
Write	22
Extension function of the pen	22
Erasing	22
Whiteboard Menu	23
Settings	24
Email Account	25
Whiteboard Functions	25

## SETTINGS

System Settings	30
Network & Internet	31
Wireless & Network	32
Wi-Fi	32
Ethernet	33
Hotspot	33
Bluetooth	34
VPN	34
Device	35
Screen Saver	36
Screenshot	37
Split Screen	37
Sidebar	38
Multi-window Mode	38
Apps	39
System	40
Date & Time	40
Language	41
Keyboard	41
Storage	40
Files	42
Software Update	43
Lock Screen	44
Security	45

---

# Table of contents

---

About	46
Quick Settings	47
Display	47
Audio	47
General	48

## Troubleshooting guide

---

Problems and solutions	49
------------------------	----

## Specifications

---

General	53
Preset timing modes	55

## Appendix

---

Responsibility for the pay service (Cost to customers)	56
Not a product defect	56
A product damage caused by customer's fault	56
Others	56
Prevention of afterimage burn-in	57
What is afterimage burn-in?	57
Recommended prevention practices	57
Licence	57
Low Blue Light	58
Tips for eye health	58
ENERGY STAR	58





# Chapter 01







## Before using the product

### Safety precautions

The following safety instructions are to ensure your personal safety and prevent property damage. Please read the following to ensure the proper use of the product.

### Safety symbols

Symbol	Name	Meaning
	Warning	A serious or fatal injury may result if instructions are not followed.
	Caution	Personal injury or damage to properties may result if instructions are not followed.
	Prohibition	Do NOT attempt.
	Instruction	Follow directions.

CAUTION			
RISK OF ELECTRIC SHOCK. DO NOT OPEN.			
CAUTION: TO REDUCE THE RISK OF ELECTRIC SHOCK, DO NOT REMOVE COVER (OR BACK). THERE ARE NO USER SERVICEABLE PARTS INSIDE. REFER ALL SERVICING TO QUALIFIED PERSONNEL.			
	This symbol indicates that high voltage is present inside. It is dangerous to make any kind of contact with any internal part of this product.		AC voltage: Rated voltage marked with this symbol is AC voltage.
	This symbol indicates that this product has included important literature concerning operation and maintenance.		DC voltage: Rated voltage marked with this symbol is DC voltage.
	Class II product: This symbol indicates that a safety connection to electrical earth (ground) is not required. If this symbol is not present on a product with a mains lead, the product MUST have a reliable connection to protective earth (ground).		Caution. Consult instructions for use: This symbol instructs the user to consult the user manual for further safety related information.

---









## Storage

Due to the characteristics of high-glossy products, using a UV humidifier nearby may create white-coloured stains on the product.





 Contact Customer Service Centre if the inside of the product needs cleaning (service fee will be charged).

## Electricity and safety

### Warning





-  Do not use a damaged power cord or plug, or a loose power socket.  
An electric shock or fire may result.
-  Do not use multiple products with a single power socket.  
Overheated power sockets may cause a fire.
-  Do not touch the power plug with wet hands. Otherwise, an electric shock may result.
-  Do not bend or pull the power cord with force. Be careful not to leave the power cord under a heavy object.  
Damage to the cord may result in a fire or electric shock.
-  Do not place the power cord or product near heat sources.  
A fire or electric shock may result.
-  Insert the power plug all the way in so it is not loose.  
An unsecure connection may cause a fire.
-  Connect the power plug to a grounded power socket (type 1 insulated devices only).  
An electric shock or injury may result.
-  Clean any dust around the pins of the power plug or the power socket with a dry cloth.  
A fire may result.







### Caution

-  Do not disconnect the power cord while the product is being used.  
The product may become damaged by an electric shock.
-  Only use the power cord provided with your product by Samsung. Do not use the power cord with other products.  
A fire or electric shock may result.
-  Keep the power socket where the power cord is connected unobstructed.  
The power cord must be disconnected to cut off power to the product when an issue occurs.
-  Hold the plug when disconnecting the power cord from the power socket.  
An electric shock or fire may result.





## Installation

### Warning

-  DO NOT PLACE CANDLES, INSECT REPELLANTS OR CIGARETTES ON TOP OF THE PRODUCT. DO NOT INSTALL THE PRODUCT NEAR HEAT SOURCES.  
A fire may result.
-  Do not install the product in poorly ventilated spaces such as a bookcase or closet.  
An increased internal temperature may cause a fire.
-  Do not install the product on an unstable or vibrating surface (insecure shelf, sloped surface, etc.)
  - The product may fall and become damaged and/or cause an injury.
  - Using the product in an area with excess vibration may damage the product or cause a fire.
-  Do not expose the product to direct sunlight, heat, or a hot object such as a stove.  
The product lifespan may be reduced or a fire may result.









-  Do not install the product within the reach of young children.
  - The product may fall and injure children.
  - As the front is heavy, install the product on a flat and stable surface.
-  Edible oil, such as soybean oil, can damage or deform the product. Do not install the product in a kitchen or near a kitchen counter.
-  Have a technician install the wall-mount hanger.
  - Installation by an unqualified person can result in an injury.
  - Only use approved cabinets.
-  Install the product at least 10 cm away from the wall to allow ventilation.  
An increased internal temperature may cause a fire.
-  Keep the plastic packaging out of the reach of children.  
Children may suffocate.
-  Do not install the product in a vehicle or a place exposed to dust, moisture (water drips, etc.), oil, or smoke.  
A fire or electric shock may result.

### Caution

-  Do not set down the product on its front.  
The screen may become damaged.
-  Do not drop the product while moving.  
Product failure or personal injury may result.
-  Set down the product gently.  
Product failure or personal injury may result.
-  Installing the product in an unusual place (a place exposed to a lot of fine dust, chemical substances, extreme temperatures or a significant presence of moisture, or a place where the product will operate continuously for an extended period of time) may seriously affect its performance.  
Be sure to consult Samsung Customer Service Centre if you want to install the product at such a place.

## Operation

### Warning

-  There is a high voltage inside the product. Never disassemble, repair or modify the product yourself.
  - A fire or electric shock may result.
  - Contact Samsung Customer Service Centre for repairs.
-  Do not let children hang from the product or climb on top of it.  
Children may become injured or seriously harmed.
-  If the product is dropped or the outer case is damaged, turn off the power switch and disconnect the power cord. Then contact Samsung Customer Service Centre.  
Continued use can result in a fire or electric shock.
-  Do not leave heavy objects or items that children like (toys, sweets, etc.) on top of the product.  
The product or heavy objects may fall as children try to reach for the toys or sweets resulting in a serious injury.
-  Do not move the product by pulling the power cord or any cable.  
Product failure, an electric shock or fire may result from a damaged cable.
-  Do not lift or move the product by pulling the power cord or any cable.  
Product failure, an electric shock or fire may result from a damaged cable.
-  Ensure the vents are not blocked by tablecloths or curtains.  
An increased internal temperature may cause a fire.
-  Do not insert metallic objects (chopsticks, coins, hairpins, etc) or objects that burn easily (paper, matches, etc) into the product (via the vent or input/output ports, etc).
  - Be sure to power off the product and disconnect the power cord when water or other foreign substances have entered the product. Then contact Samsung Customer Service Centre.
  - Product failure, an electric shock or fire may result.

 Do not place objects containing liquid (vases, pots, bottles, etc) or metallic objects on top of the product.

- Be sure to power off the product and disconnect the power cord when water or other foreign substances have entered the product. Then contact Samsung Customer Service Centre.
- Product failure, an electric shock or fire may result.

 Before moving the product, turn off the power switch and disconnect the power cable and all other connected cables.

Damage to the cord may result in a fire or electric shock.

 If the product generates abnormal sounds, a burning smell or smoke, disconnect the power cord immediately and contact Samsung Customer Service Centre.

An electric shock or fire may result.

 During a lightning or thunderstorm, power off the product and remove the power cable.

A fire or electric shock may result.

 Do not drop objects on the product or apply impact.

A fire or electric shock may result.

 If a gas leakage is found, do not touch the product or power plug. Also, ventilate the area immediately.

Sparks can cause an explosion or fire.

 Do not use or keep combustible spray or an inflammable substance near the product.

An explosion or fire may result.

 **Caution**

 Do not use humidifiers or stoves around the product.

A fire or electric shock may result.

 Do not touch the screen when the product has been turned on for an extended period of time as it will become hot.

 Do not place heavy objects on the product.

Product failure or personal injury may result.

 Leaving the screen fixed on a stationary image for an extended period of time may cause afterimage burn-in or defective pixels.

Activate power-saving mode or a moving-picture screen saver if you will not be using the product for an extended period of time.

 Disconnect the power cord from the power socket if you do not plan on using the product for an extended period of time (vacation, etc).

Dust accumulation combined with heat can cause a fire, electric shock or electric leakage.

 Use the product at the recommended resolution and frequency.

Your eyesight may deteriorate.

 Looking at the screen too close for an extended period of time can deteriorate your eyesight.

 Rest your eyes for more than 5 minutes for every 1 hour of product use.

Eye fatigue will be relieved.

 Store small accessories out of the reach of children.



---

## Precautions for use

Be careful that if you use the supplied pen with a load exceeding 2.5 kg, scratches may occur on the protective glass.

If you use a ballpoint pen other than the supplied pen, be careful that the screen may be stained with ink or damaged.

**Do not use a dirty brush to avoid screen damage.**

-  We recommend that you use the supplied pen. Do not use sharp, pointed objects other than the pen.
-  If dust or dirt from the supplied pen remains on the protective glass, clean it referring to the instructions below.

### Cleaning the exterior and display

Wipe the surface with a slightly wet, soft cloth, and then wipe with a dry cloth.

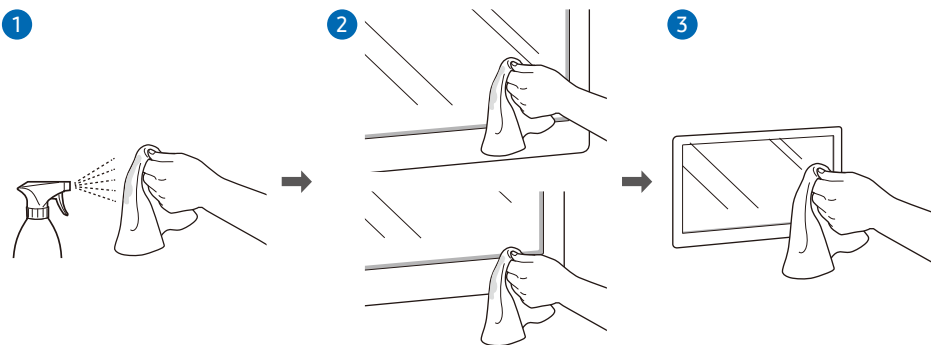

# Chapter 02

## Preparations

### Checking the components

- Contact the vendor where you purchased the product if any components are missing.
- The appearance of the components may differ from the images shown.
- Refer to the installation guide for the WMB stand or wall mount (available for optional purchase).



Quick Setup Guide



Warranty card  
(Not available in some locations)



Regulatory guide



Power cord

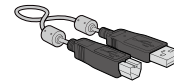

USB cable



Touch pen x2



HDMI cable

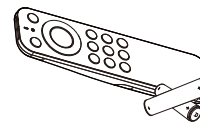



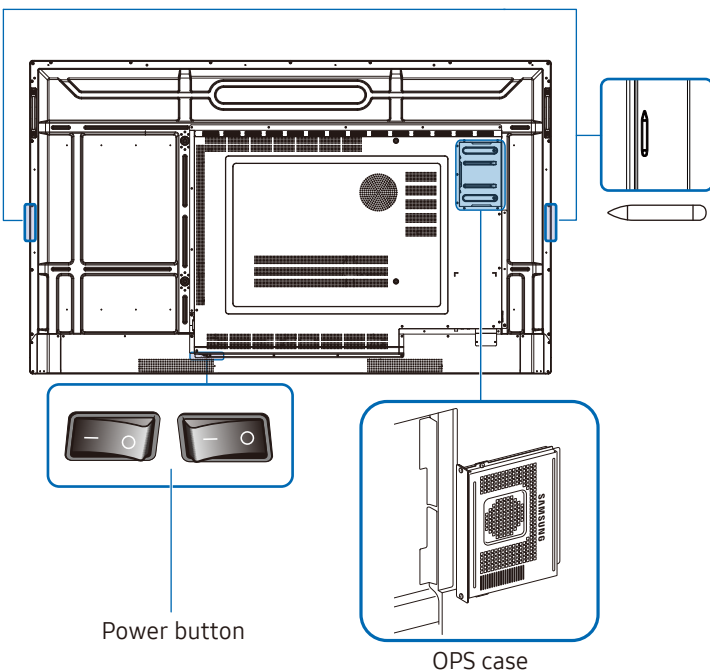
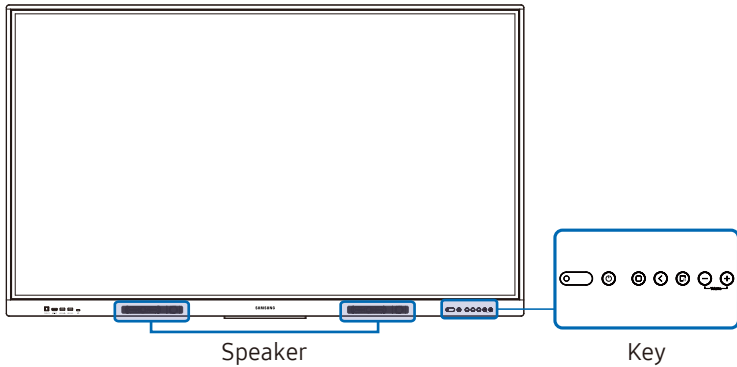

Remote control  
(batteries x 2 included)

# Parts

## WA65F/WA75F/WA86F

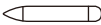

 The colour and shape of parts may differ from what is shown. Specifications are subject to change without notice to improve quality.

Parts	Description
Speaker	Speaker output
Key	<ol style="list-style-type: none"> <li>1 power indicator: Adjust the brightness of the panel according to the actual scenery if the user turns on the auto brightness</li> <li>2 power button</li> <li>3 home button: switch to the Android home page</li> <li>4 return button: return</li> <li>5 freeze button: when press this button , the screen and the picture will be frozeed and cannot be touched</li> <li>6 volume down</li> <li>7 volume up</li> </ol>
Power button	<p>Press the button to turn on the product and press and hold the button to turn off the product.</p> <p>In writing mode, shortly press the <b>Power</b> button to switch to the screen saver mode.</p> <p>In case the PIP screen is in <b>Full Screen</b> mode, press the <b>Power</b> button to display the adjustment menu. Press again to hide.</p>
	The pen is magnetic. Keep it by attaching to the marked location.
OPS case	<p>Connect the OPS case to the product and insert the standard OPS module into the case. You can purchase the OPS case and module separately.</p> <p> Before inserting the OPS module, make sure to remove the power cable from the product to completely cut off the power supply.</p> <p> OPS refers to the Intel Open Pluggable Specification.</p> <p> OPS power supply: 18V/3.5A</p>

# Ports

## WA65F/WA75F/WA86F

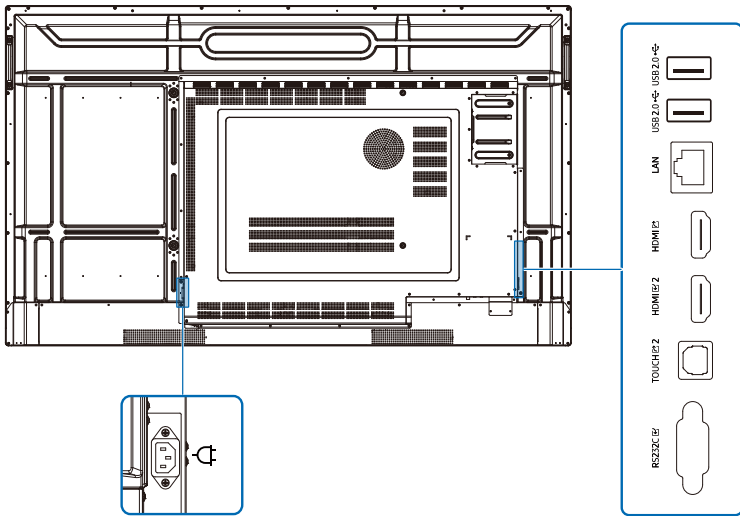

*The colour and shape of parts may differ from what is shown, Specifications are subject to change without notice to improve quality.*

Ports	Description
USB 2.0	Connect to a USB memory device. <i>The USB ports on the product accept a maximum constant current of 1.0A. If the maximum value is exceeded, USB ports may not work.</i>
USB 2.0	Connect to a USB memory device. <i>The USB ports on the product accept a maximum constant current of 1.0A. If the maximum value is exceeded, USB ports may not work.</i>
LAN	Connects to a network using a LAN cable. (1000 Mbps) Below port: Connect RJ45 output terminal Above port: Connect RJ45 input terminal
HDMI	Connects to a sink device using a HDMI cable.
HDMI 2	Connects to a source device using a HDMI cable.
TOUCH 2	Allows touch-based control of the PC screen connected through the HDMI or DP port. Use the supplied USB cable to connect between the TOUCH port on the rear of the product and the PC.
RS232C	Serial Interface for debug only.
	Power interface

# Tray

## WA65F/WA75F/WA86F

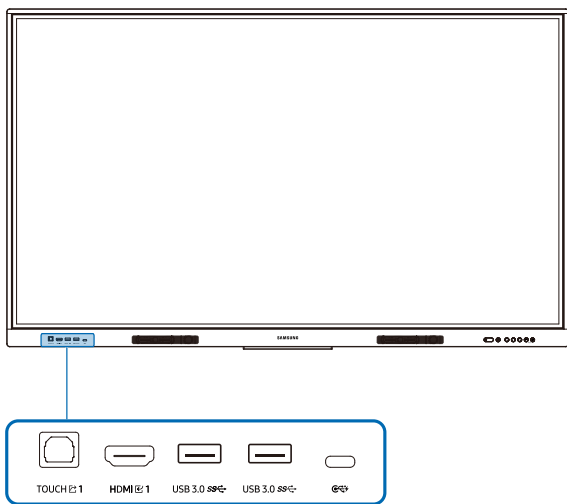

The colour and shape of parts may differ from what is shown, Specifications are subject to change without notice to improve quality.

Ports	Description
TOUCH	Allows touch-based control of the PC screen connected through the HDMI1  port. Use the supplied USB cable to connect between the TOUCH port on the rear of the product and the PC.
HDMI  1	Connects to a source device using a HDMI cable.
USB 3.0	Connect to a USB memory device. The USB ports on the product accept a maximum constant current of 1.0A. If the maximum value is exceeded, USB ports may not work.
USB 3.0	Connect to a USB memory device. The USB ports on the product accept a maximum constant current of 1.0 maximum value is exceeded, USB ports may not work.
	You can connect a device using a USB-C cable. <ul style="list-style-type: none"><li>• USB-C connection allows video output and touch-based control of the device.</li><li> You must use a USB-C cable with DP ALT Mode support for video transmission.</li><li> Use a USB-C cable that is 1 m or shorter in length.</li><li> Charging is supported up to 65 W. Charging with USB-C cable is only available when the product is on.</li></ul>

## Before installing the product (Installation guide)

This product can be wall-mounted. The wall mount are available for optional purchase.

### WA65F/WA75F/WA86F

#### Ventilation

 Contact Samsung Customer Service Center for further details.

#### Installation on a perpendicular wall

- A Minimum 30 mm
- B Ambient temperature: 35 °C or less

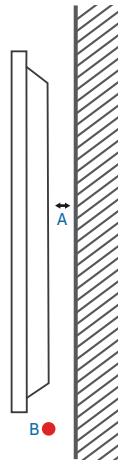

#### Installation on an indented wall

- A Minimum 30 mm
  - B Minimum 25 mm
  - C Ambient temperature: 35 °C or less
-  When installing the product on an indented wall, allow at least the space specified above between the product and wall for ventilation and ensure that the ambient temperature is kept below 35 °C.

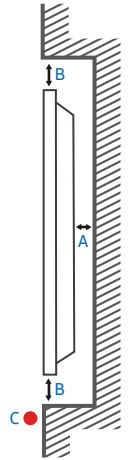

---

## Installing the wall mount

 This product can be wall-mounted. The wall mount are available for optional purchase.

### Using the wall mount kit

- The wall mount kit allows you to mount the product on the wall.
- For detailed information on installing the wall mount, see the instructions provided with the wall mount.
- We recommend you contact a technician for assistance when installing the wall mount bracket.
- Samsung is not responsible for any damage to the product or injury to yourself or others if you select to install the wall mount on your own.

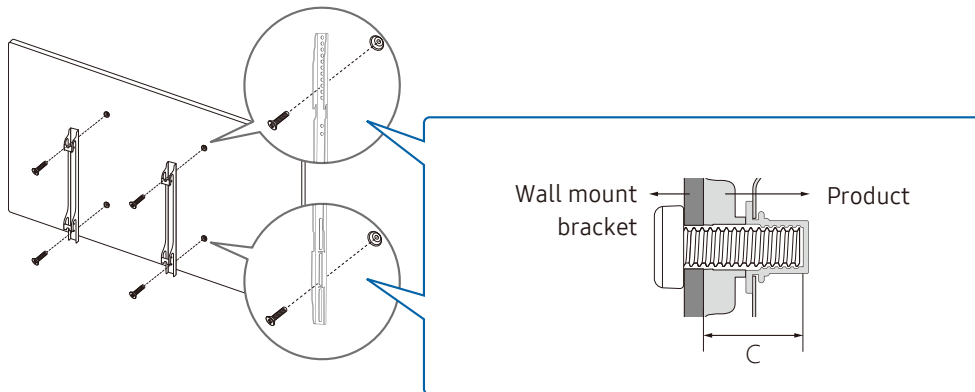

## Wall mount kit specifications (VESA)

 Install your wall mount on a solid wall perpendicular to the floor. To install the product on the other wall area, contact the nearest agency. If you install the product on a slanted wall, it may fall and result in severe personal injury.

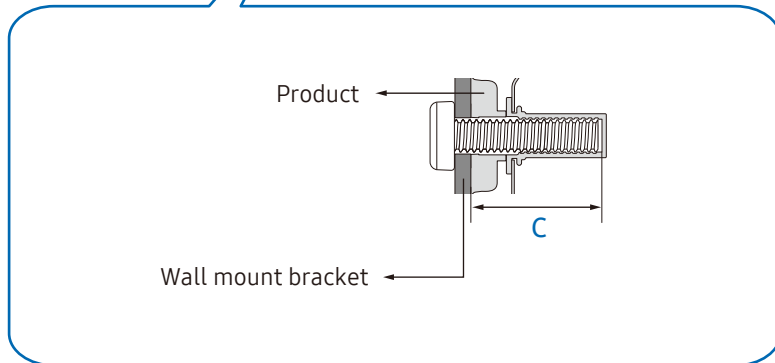
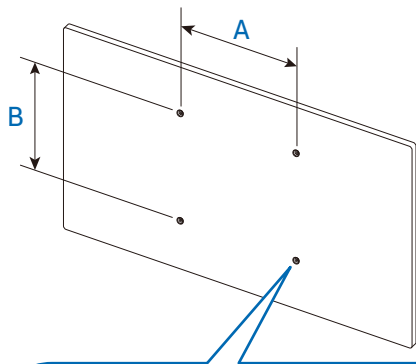

- Samsung wall mount kits contain a detailed installation manual and all parts necessary for assembly are provided.
- Do not use screws that are longer than the standard length or do not comply with the VESA standard screw specifications. Screws that are too long may cause damage to the inside of the product.
- For wall mounts that do not comply with the VESA standard screw specifications, the length of the screws may differ depending on the wall mount specifications.
- Do not fasten the screws too firmly. This may damage the product or cause the product to fall, leading to personal injury. Samsung is not liable for these kinds of accidents.
- Samsung is not liable for product damage or personal injury when a non-VESA or non-specified wall mount is used or the consumer fails to follow the product installation instructions.
- Always have at least two people mount the product on a wall.
- Standard dimensions for wall mount kits are shown in the table below.

Model name	VESA screw hole specs (A x B) in millimetres	C (mm)	Standard screw	Quantity
WA65F	600 x 400	23 - 25	M8	4
WA75F	800 x 400	23 - 25		
WA86F	800 x 600	23 - 25		

 Do not install your Wall Mount Kit while your product is turned on. It may result in personal injury due to electric shock.

# Connecting to a network

 Connecting parts may differ in different products.

## Network settings (Wired)

### Connecting to a wired network

There are three ways to attach your product to your LAN using cable.

- You can attach your product to your LAN by connecting the LAN port on the back of your product to an external modem using a LAN cable. See the diagram below.

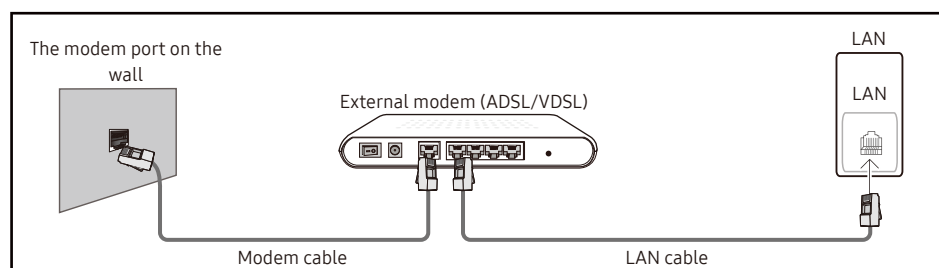

- You can attach your product to your LAN by connecting the LAN port on the back of your product to an IP sharer which is connected to an external modem. Use LAN cable for the connection. See the diagram below.

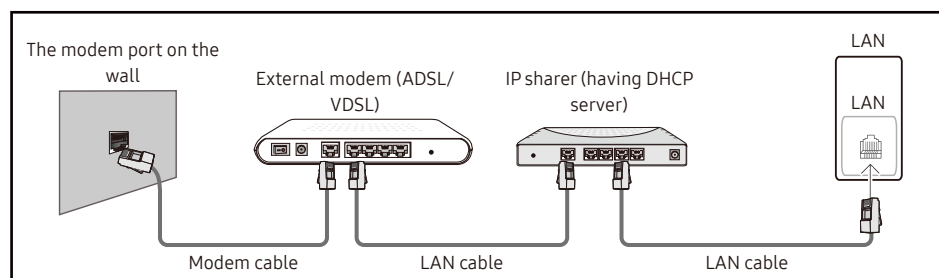

- Depending on how your network is configured, you may be able to attach your product to your LAN by connecting the LAN port on the back of your product directly to a network wall outlet using a LAN cable.

See the diagram below. Note that the wall outlet is attached to a modem or router elsewhere in your house.

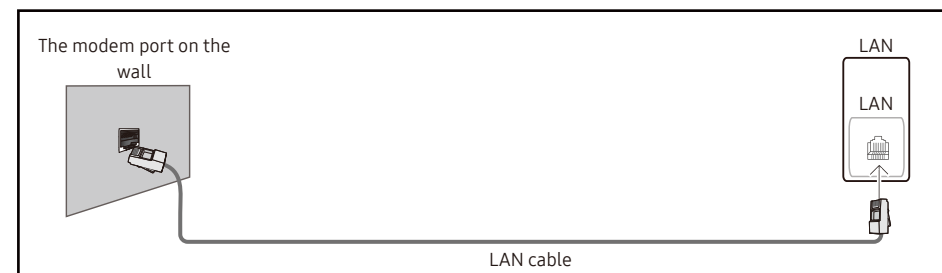

If you have a Dynamic Network, you should use an ADSL modem or router that supports the Dynamic Host Configuration Protocol (DHCP). Modems and routers that support DHCP automatically provide the IP address, subnet mask, gateway, and DNS values your product needs to access the Internet so you do not have to enter them manually. Most home networks are Dynamic Networks.

Some networks require a Static IP address. If your network requires a Static IP address, you must enter the IP address, subnet mask, gateway, and DNS values manually on your product Cable Setup Screen when you set up the network connection. To get the IP address, subnet mask, gateway, and DNS values, contact your Internet Service Provider (ISP).

If you have a Windows computer, you can also get these values through your computer.

 You can use ADSL modems that support DHCP if your network requires a Static IP address.

 ADSL modems that support DHCP also let you use Static IP addresses.

---



Set the network connection to use Internet services such as perform software upgrades.

## Automatic Open Network Settings (Wired)

Connect to the network using a LAN cable.

Make sure a LAN cable is connected first.

### How to set up automatically

- 1 Set **Network Type** to **Wired** from the **Open Network Settings** page.
  - 2 The network connection screen appears, and the verification process starts.
  - 3 When the connection has been verified, the **OK** button appears on the bottom of the screen.
  - 4 Tap **OK**.
-  If the connection process fails, check the LAN port connection.
-  If the automatic process cannot find the network connection values or if you want to set the connection manually, go to the next section, "[Manual Open Network Settings \(Wired\)](#)".

## Manual Open Network Settings (Wired)

Offices may use static IP addresses.

If this is the case, ask the network administrator for the IP address, subnet mask, gateway and DNS server address. Enter these values manually.

### Getting the network connection values

To view the Network connection values on most Windows computers, follow these steps.

- 1 Right click the **Network** icon on the bottom right of the screen.
- 2 In the pop-up menu that appears, click **Status**.
- 3 On the dialog that appears, click the **Support** tab.
- 4 On the **Support** tab, click the **Details** button. The Network connection values are displayed.

### How to set up manually

- 1 Set **Network Type** to **Wired** from the **Open Network Settings** page.
- 2 The network connection screen appears, and the verification process starts.
- 3 Select **Cancel** while network connections are being attempted. This will stop the connection.
- 4 Select **IP Settings** on network connection screen. The **IP Settings** screen appears.
- 5 Select the field at the top and then set **IP setting** to **Enter manually**.  
 Setting **IP setting** to **Enter manually** automatically changes **DNS setting** to **Enter manually**.
- 6 Enter the **IP Address**, **Subnet mask**, **Gateway**, and **DNS Server** values manually.
- 7 When done, select **OK** at the bottom of the page. The network test screen appears and the verification process starts.
- 8 When the connection has been verified, the **OK** button appears on the bottom of the screen.
- 9 Tap **OK** to complete the setting.

## Network settings (Wireless)

### Connecting to a wireless network

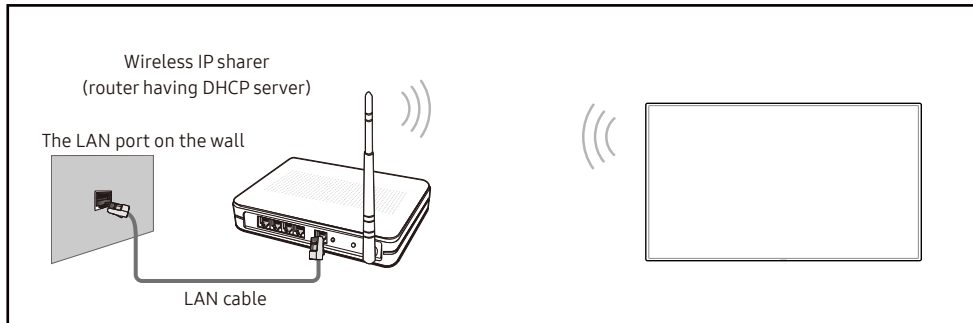

Samsung recommends using IEEE 802.11n. When you play video over a network connection, the video may not play smoothly.

- Select a channel for the wireless IP sharer that is not currently being used. If the channel set for the wireless IP sharer is currently being used by another device nearby, this will result in interference and communication failure.
- Your product supports only the following wireless network security protocols. If you select the Pure High-throughput (Greenfield) 802.11n mode and the encryption type is set to WEP, TKIP or TKIP AES (WPS2Mixed) on your AP or wireless router, Samsung products will not support a connection in compliance with new Wi-Fi certification specifications.
- If your wireless router supports WPS (Wi-Fi Protected Setup), you can connect to the network via PBC (Push Button Configuration) or PIN (Personal Identification Number). WPS will automatically configure the SSID and WPA key in either mode.
- Connection methods: You can setup the wireless network connection in three ways. Auto Setup (Using the Auto Network Search function), Manual Setup, Use WPS
- This product supports Enterprise WPA2 (TLS/TTLS/PEAP).

### Automatic network setup (Wireless)

Most wireless networks have an optional security system that requires devices that access the network to transmit an encrypted security code called an Access or Security Key. The Security Key is based on a Pass Phrase, typically a word or a series of letters and numbers of a specified length you were asked to enter when you set up security for your wireless network. If you use this method of setting up the network connection, and have a Security Key for your wireless network, you will have to enter the Pass Phrase during the automatic or manual setup process.

#### How to set up automatically

- Set **Network Type** to **Wireless** from the **Open Network Settings** page.
- The product searches for available wireless networks. When done, it displays a list of the available networks.
- In the list of networks, select a network.
  - If the desired wireless router does not appear, select **Refresh** to search again.
  - If the router cannot be found after retrying, select **Add Network**.
- If you selected a password-protected network, enter the password, and tap **Go**.
  - You may skip this step if you selected an open network.
- The network connection screen appears, and the verification process starts.
- When the connection has been verified, the **OK** button appears on the bottom of the screen.
- Tap **OK**.

### Manual network setup (Wireless)

Offices may use static IP addresses.





If this is the case, ask the network administrator for the IP address, subnet mask, gateway and DNS server address. Enter these values manually.

#### Getting the network connection values

To view the network connection values on most Windows computers, follow these steps.

- 
- 1 Right click the **Network** icon on the bottom right of the screen.
  - 2 In the pop-up menu that appears, click **Status**.
  - 3 On the dialog that appears, click the **Support** tab.
  - 4 On the **Support** tab, click the **Details** button. The Network connection values are displayed.

### How to set up manually

- 1 Set **Network Type** to **Wireless** from the **Open Network Settings** page.
- 2 The product searches for available wireless networks. When done, it displays a list of the available networks.
- 3 In the list of networks, select a network.
  -  If the desired wireless router does not appear, select **Refresh** to search again.
  -  If the router cannot be found after retrying, select **Add Network**.
- 4 If you selected a password-protected network, enter the password, and tap **Go**.
  -  You may skip this step if you selected an open network.
- 5 The network connection screen appears, and the verification process starts.
- 6 Select **Cancel** while network connections are being attempted. This will stop the connection.
- 7 Select **IP Settings** on network connection screen. The **IP Settings** screen appears.
- 8 Select the field at the top and then set **IP setting** to **Enter manually**.
  -  Changing **IP setting** to **Enter manually** automatically changes **DNS setting** to **Enter manually**.
- 9 Enter the **IP Address**, **Subnet mask**, **Gateway**, and **DNS Server** values manually.
- 10 When done, select **OK** at the bottom of the page. The network test screen appears, and the verification process starts.
- 11 When the connection has been verified, the **OK** button appears on the bottom of the screen.
- 12 Tap **OK** to complete the setting.

### How to set up using the WPS button

If your router has a WPS button, follow these steps.

- 1 Set **Network Type** to **Wireless** from the **Open Network Settings** page.
- 2 Select **Use WPS**.
- 3 Press the WPS or PBC button on your wireless router within the next two minutes. Your product automatically acquires all the network setting values it needs and connects to your network.
- 4 The network connection screen appears, and network setup is done.

# Chapter 03

## Writing

### Whiteboard - Entry

Find related applications on the home screen.



### Pen

Pen feature has various pen types and allows you to select the color and adjust the thickness of the pen.

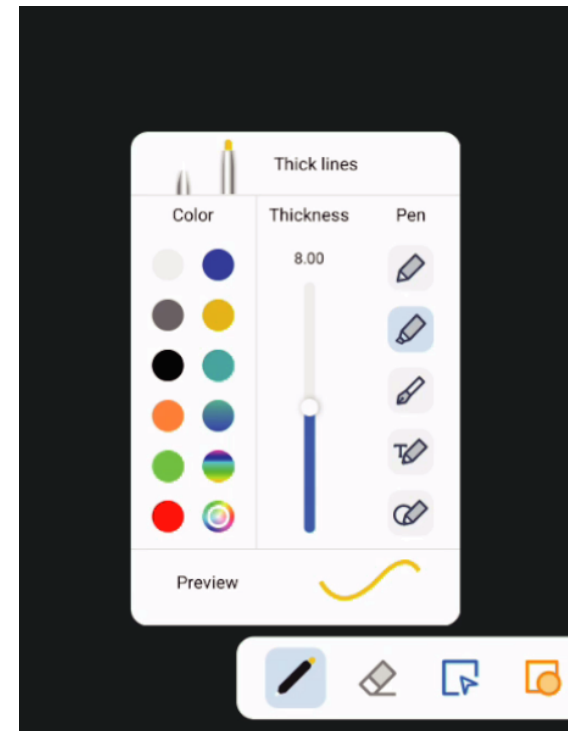

# Pen Mode

## Screen elements

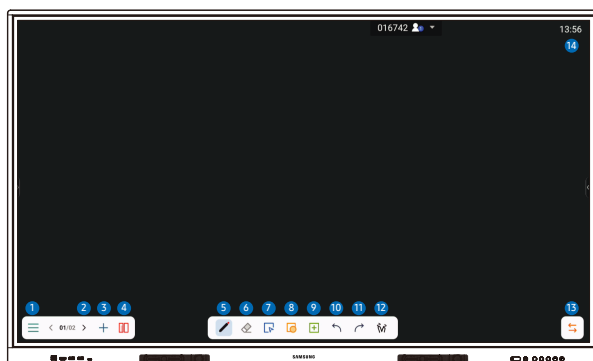

Buttons	Description
1  Menu	The menu contains new, save, share, close, and various settings of the whiteboard.
2  Page Management	Page management is mainly to manage the individual pages of the whiteboard. including: Previous page, Next pag, Add page, Current page number.
3  Add Page	Click to add a new page after the current page and jump to the new page display.
4  Split Screen	Click split screen writing to choose to divide the whiteboard into two screens, three screens or four screens.
5  Pen	Click the selected brush aqain to set the stroke size (which can be automatically recognized), the color of the writing, the weight of the writing, and the stroke type.
6  Eraser	After writing, you can erase the content directly with the palm, and also you can choose circle erasing, path erasing or one-click swipe clear.
7  Select	Click the select button to switch to select mode, click the handwriting or picture and other elements to select the element, and the selected part can be enlarged, reduced and rotated. At the same time, you can also switch the color of multiple handwriting, search the picture (long press the searched picture to put the picture into the whiteboard), copy and delete.
8  shape	Select a graphic and move it with touch to draw different geometric shapes, including lines, plane shapes,and stereo shapes.
9  Tools	A variety of tools can be inserted into the whiteboard, including images, tables, math tools, channels, mind maps, documents, videos, browsers, votekit, timer.
10  Undo	Click the undo button to undo the last step of the operatlon, up to 30 steps are supported to undo.
11  Redo	Click the redo button to resume the last undo operation.
12  Multi-fingerWriting	You can choose either Multi-finger writing mode or Multi-finger scaling/moving mode
13  Toggle layout	Switch Whiteboard menu and page control positions to left or right
14  Time	The time display can be switched on or off in the settings.

## Write

Use the supplied pen to write on the display.

- Thin tip (A): Pen type
- Thick tip (B): Thick Pen

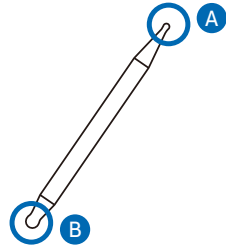

## Extension function of the pen

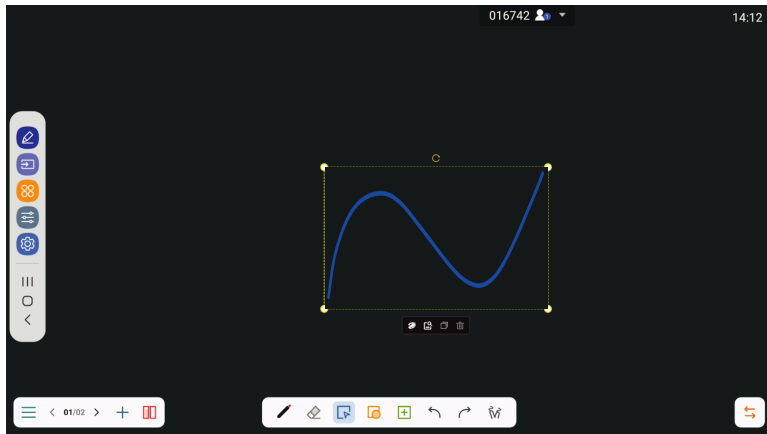

After writing, you can select the handwriting by using the selection tool and you can adjust the color, search the handwriting, copy the handwriting or delete it.

## Erasing

Select **Eraser** to erase the written content. You can use your palm to erase the content in a large area on the screen. You can also **clear** all contents by dragging button to right.

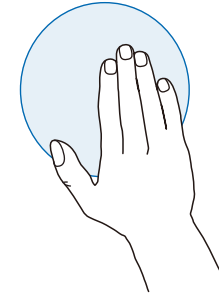
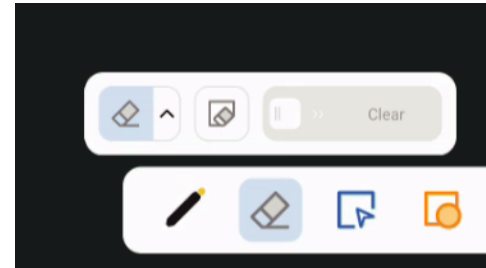

Erase selection for removing the content. And the erase size can be resizable

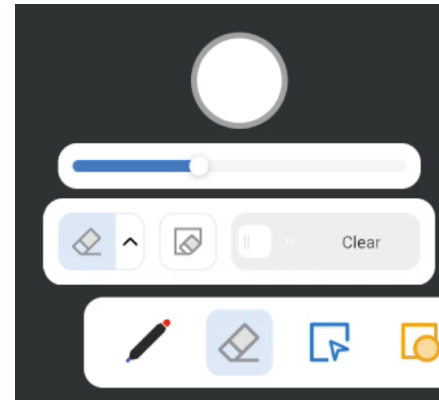

## Whiteboard Menu

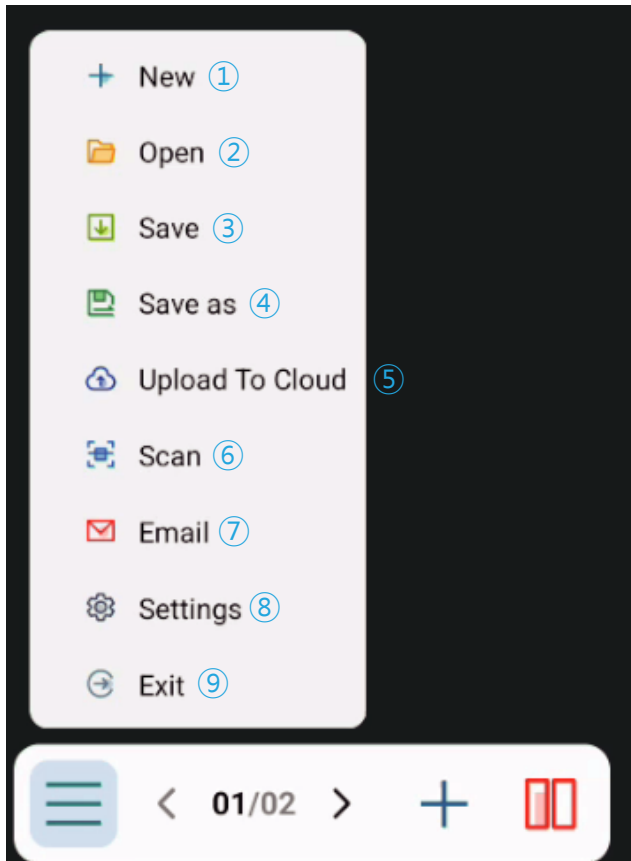

Item	Description
1 New	Click to create a new whiteboard and the current document will be closed; if the current document is not saved, the user will be prompted to save the file before creating a new one;
2 Open	Enter the file manager, display all whiteboard files, click to open the file; if the current document is not saved, the user will be prompted to save the file before opening a new file;
3 Save	Click to save the current file, support to set the name of the document, document type, storage location;
4 Save as	Store a file in addition to the current file. It supports setting the document name, document type, storage location, and can check whether to delete blank pages.
5 Upload To cloud	Upload the whiteboard file to the network disk for saving, and you can choose different formats, such as: source whiteboard file, png, pdf files.
6 Scan	Click to present and share the QR code, and users can download the whiteboard picture file by scanning the code; Click the encryption above the QR code to generate a digital password, After scanning the code, you need to enter the password to obtain the content.
7 Email	The whiteboard file can be sent directly through the binding mailbox.
8 Settings	The general Settings of the whiteboard are used to set the various states of the whiteboard according to the requirements.
9 Exit	Click to exit the whiteboard, close the page and process; If the current document is not saved, the user will be prompted to save the file.

## Settings

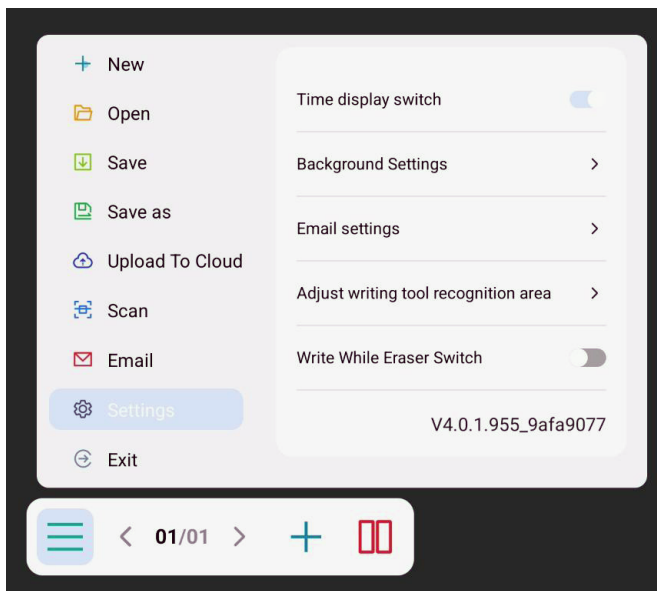

## Email Account

Setting up an Email account allows you to send files via Whiteboard.

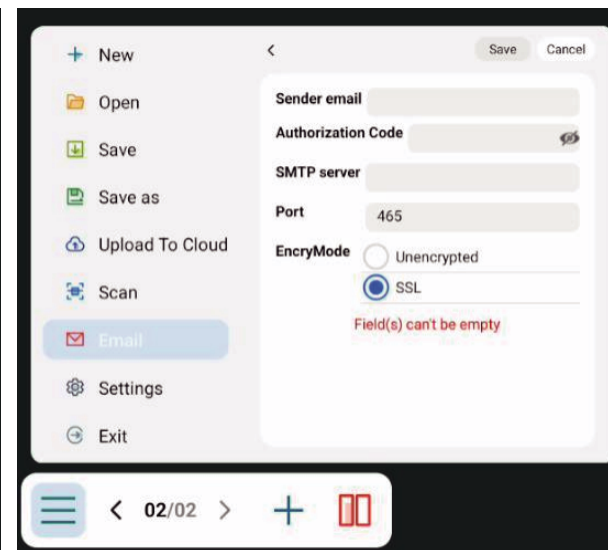
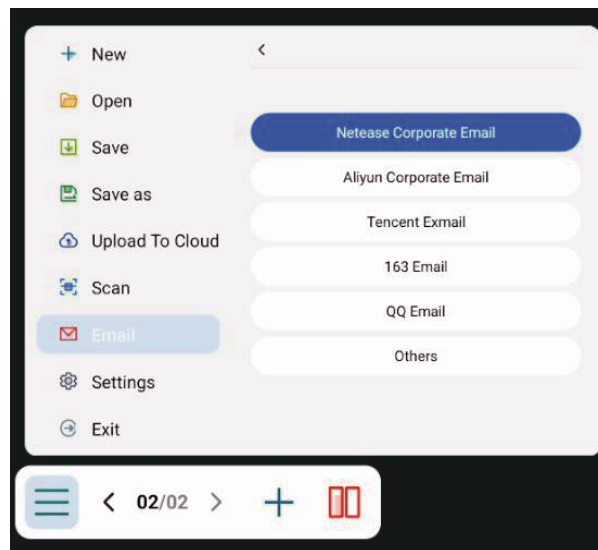

Item	Description
1 Time display switch	Control whether the time on the upper right corner of the whiteboard is displayed.
2 Background Settings	Set the background style (background color, background picture, grid background).
3 Email settings	Click to add email.
4 Adjust writing tool recognition area	Adjust thresholds for board eraser, fine pen, and thick pen.
5 Write While Eraser Switch	When this function is turned on, the board can be used to erase while writing on the whiteboard; When turned off, erasure and writing cannot be carried out at the same time.

## Whiteboard Functions

### QR code-based sharing

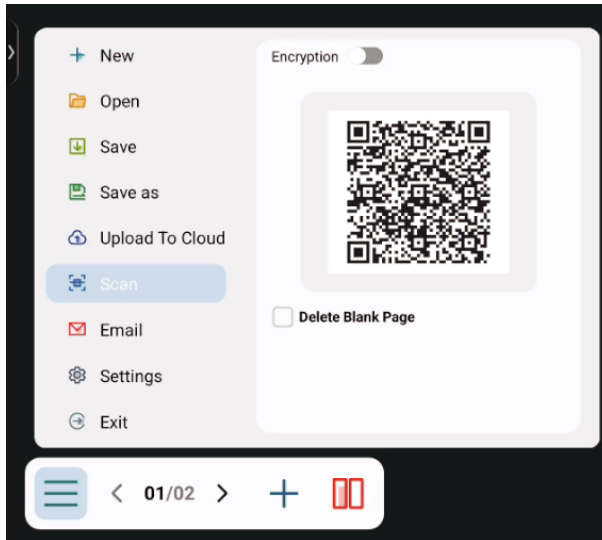

Tap the QR code to enlarge it.

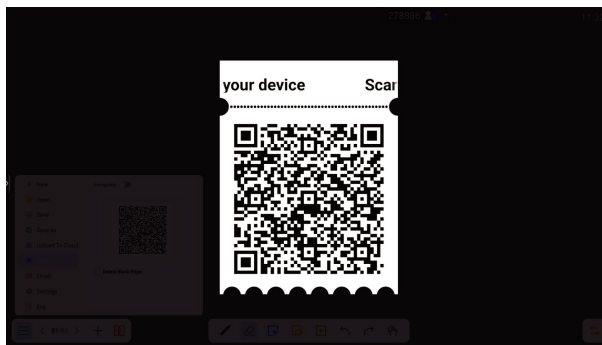

### Whiteboard canvas list

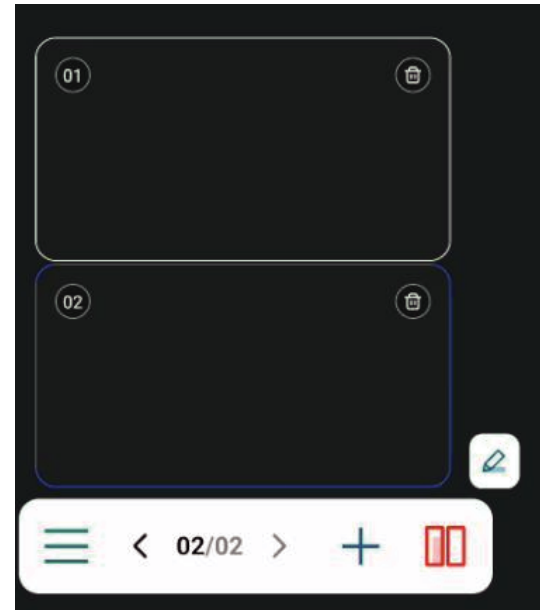

## Pen settings

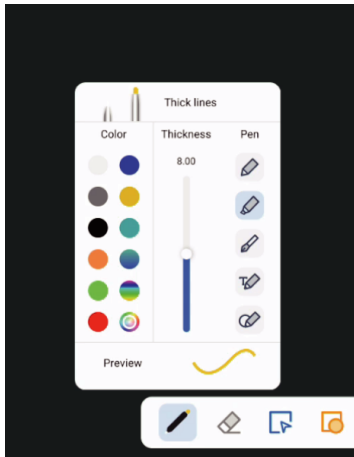

Adjust the eraser size.

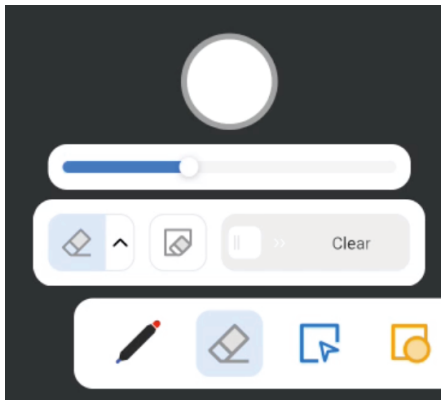

## Ruler

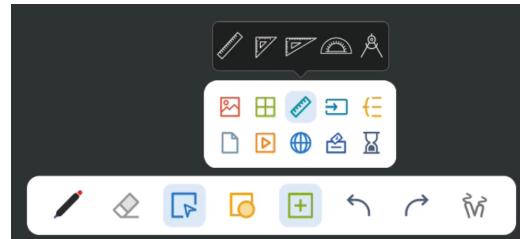

Select ruler type to use.

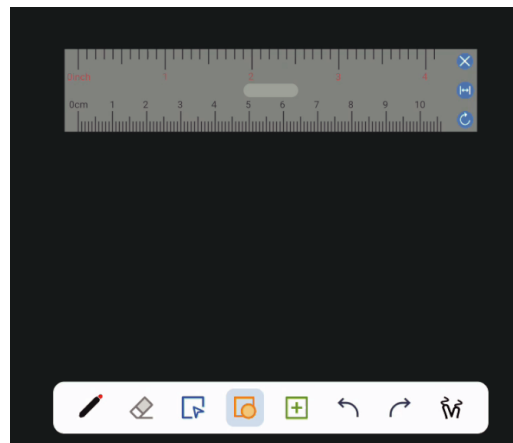

## Shape

You can insert a 3D shape and preset its color.

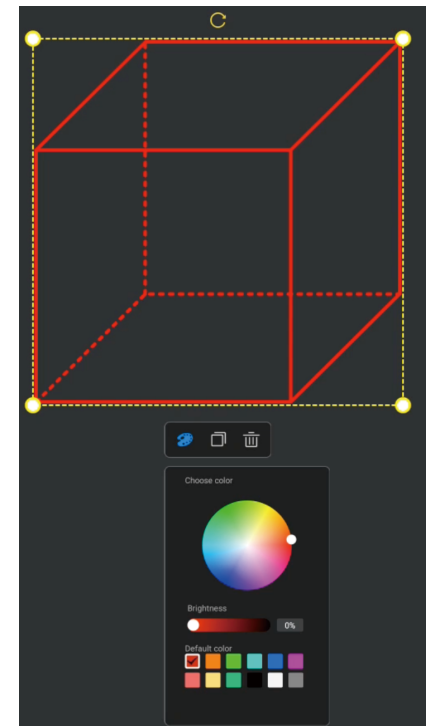
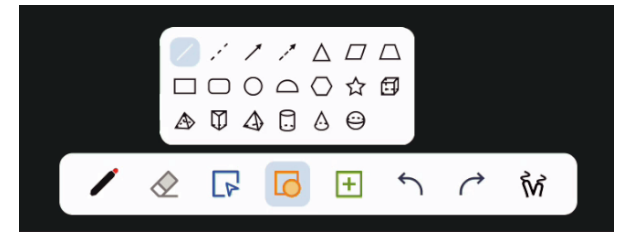

## Form



A form is inserted as shown.

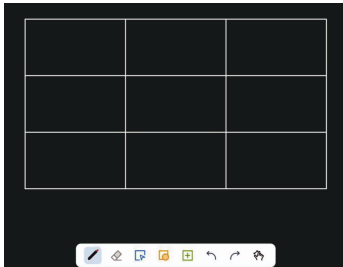

The cells in the form automatically adapt to the handwriting size.

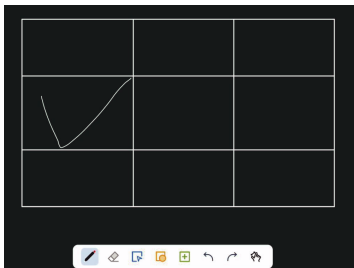

## Mind map

A mind map is inserted as shown.

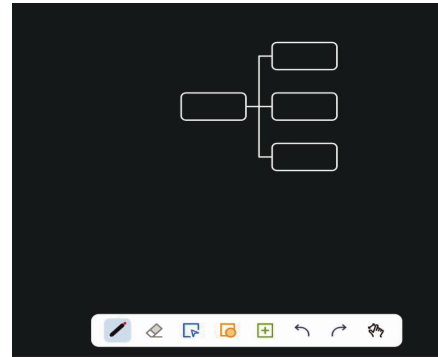

Nodes in mind maps automatically adapt to the size of handwriting.

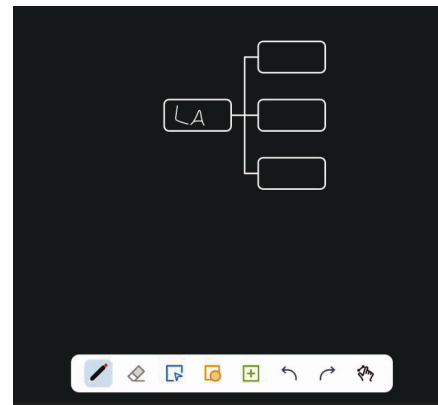

## Selection

Different functions are available for different content. Below are examples.

**Shape:** After selecting a shape, you can change the frame/fill color of the shape and flip, pin to top, clone, or delete it.

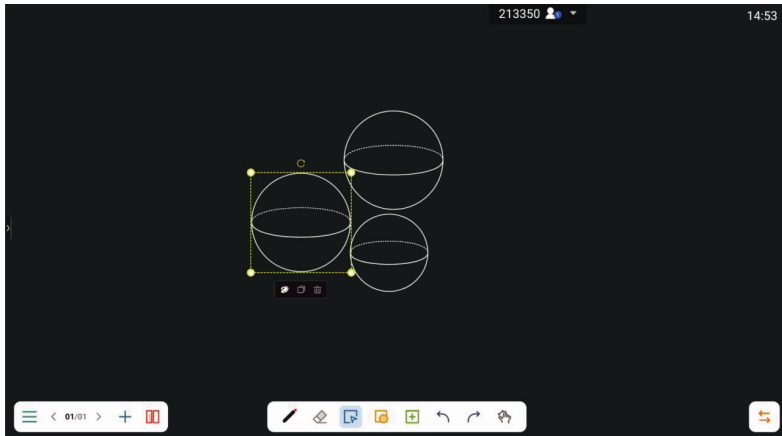

**Mind map:** After selecting a mind map, you can change the color or text color of the mind map and pin to top, clone, or delete it.

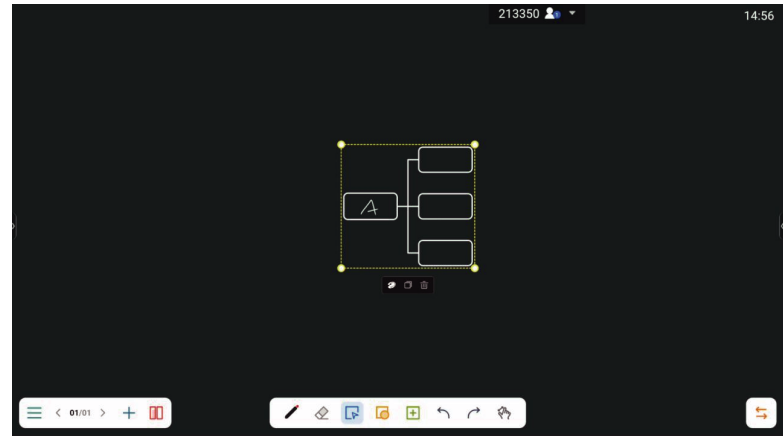

**Form:** After selecting a form, you can pin to top or delete the form.

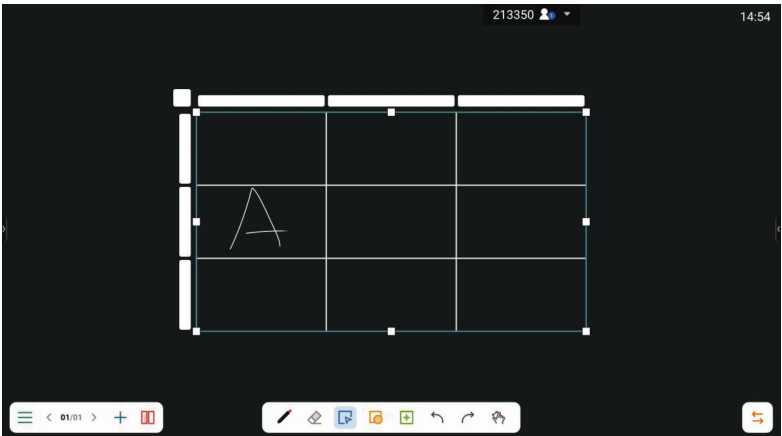

## Page

Tap **Page** to view, select, or delete all pages that are added to the note.

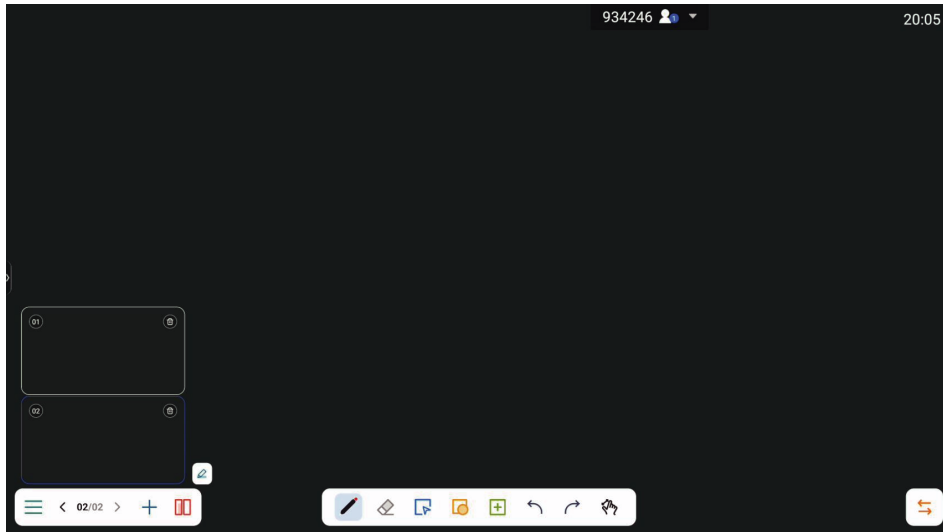

## Exit

Tap **Exit**.  
You are prompted whether to save the file.

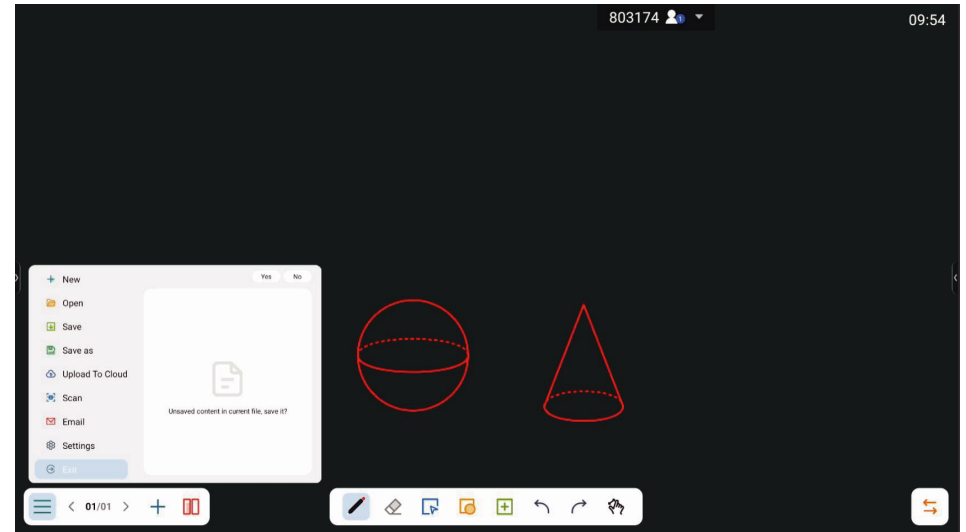

















# Chapter 04

## SETTINGS

### System Settings

From system settings, various settings can be managed.

Function	Description
 <b>Network &amp; Internet</b>	Wi-Fi, hotspot
 <b>Connected Devices</b>	Bluetooth, pairing
 <b>Apps</b>	Recent apps, default apps
 <b>Notifications</b>	Notification history, conversations
 <b>Storage</b>	Used storage, free storage
 <b>Sound &amp; Vibration</b>	Manage system sound settings
 <b>Display</b>	Dark theme, font size, brightness
 <b>Wallpaper</b>	Home, lock screen
 <b>Accessibility</b>	Display, interaction, audio

Function	Description
 <b>Security &amp; Privacy</b>	Screen lock, Find My Device, app security and Permissions account activity, personal data
 <b>Location</b>	Apps accessing to location
 <b>Safety &amp; Emergency</b>	Emergency SOS, medical info, alerts
 <b>Passwords &amp; Accounts</b>	Saved passwords, autofill, synced accounts
 <b>Digital Wellbeing &amp; Parental Controls</b>	Screen time, app timers, bedtime schedules
 <b>Google</b>	Services & preferences
 <b>System</b>	Languages, gestures, time, backup
 <b>About Table</b>	65 intercity Display

# Network & Internet

This page is the home page after entering the system settings, which mainly shows the current network status, and related network information.

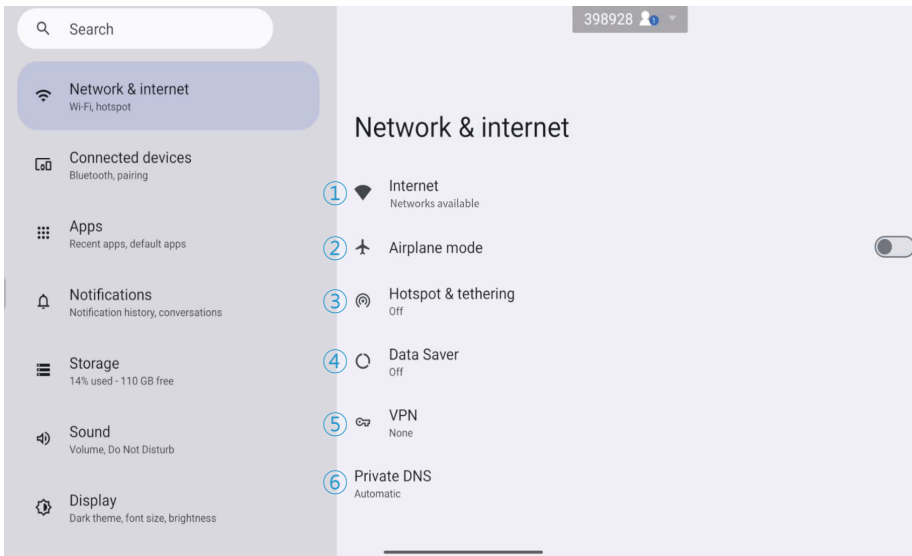

Item	Description
1 Internet	Set up the system network connection.
2 Airplane mode	Select to turn off/on flight mode.
3 Hotspot & tethering	Click whether to turn on the hotspot and see how the network is shared.
4 Data Saver	Tap whether to turn on the Traffic Saver and see the apps that are not subject to traffic restrictions.
5 VPN	View added vpn.
6 Private DNS	Click to select the private DNS mode, there ere off automatic, private DNS provider hostname, and add Enter hostname of DNS prcvide can be selected.

# Wireless & Network

## Wi-Fi

Once Wi-Fi is turned on, you can browse the list of available Wi-Fi networks and select one to establish a connection.

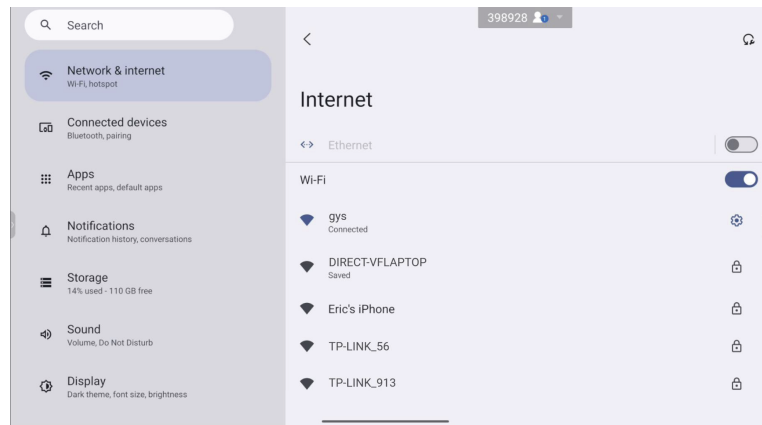

You can also click Add New Network to add and connect to a hidden network.

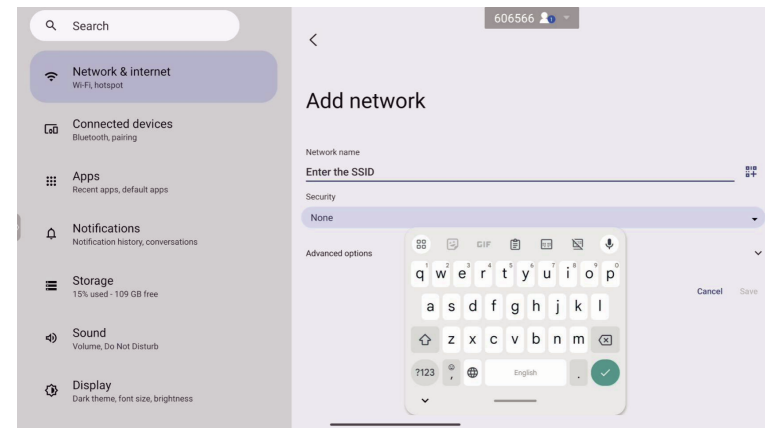

Tap a connected Wi-Fi network to view the details:

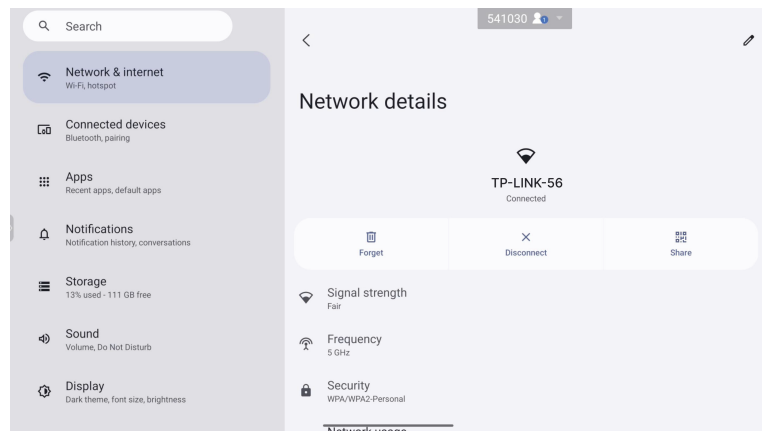

# Ethernet

If a network cable is connected, you can configure the network in the **Ethernet** option.

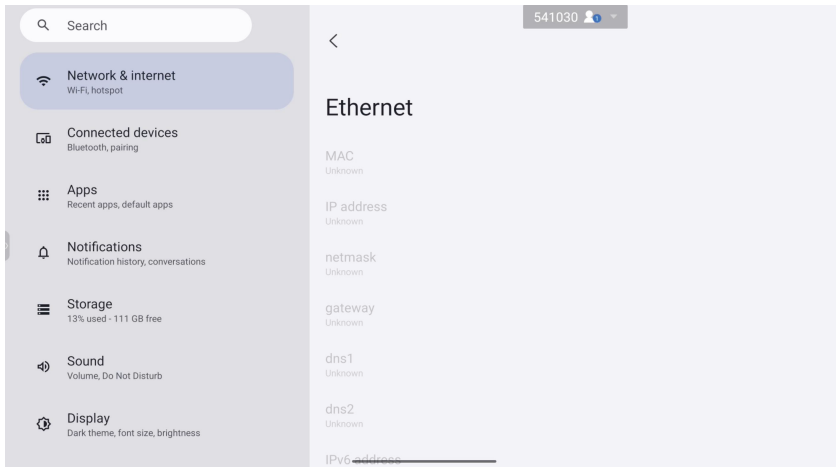

You can select automatic or manual configuration. In automatic configuration, the system automatically obtains the IP address and other information about the Ethernet and establishes the connection. In manual configuration, you need to manually enter the corresponding information.

You can also configure an Ethernet proxy for proxy-based access.

# Hotspot

Turning on the hotspot feature allows you to specify a hotspot name and password to control device access.

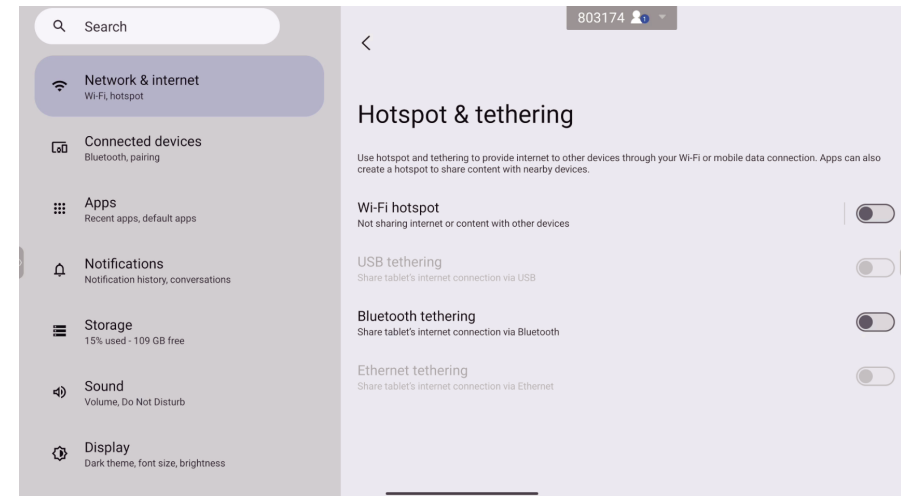

Item	Description
<b>Wi-Fi hotspot</b>	Ethernet tethering.
<b>USB tethering</b>	Sharing internet connection via USB.
<b>Bluetooth tethering</b>	Sharing internet connection via Bluetooth.
<b>Ethernet tethering</b>	Sharing internet connection via Ethernet.

# Bluetooth

Enabling Bluetooth allows you to configure Bluetooth settings.

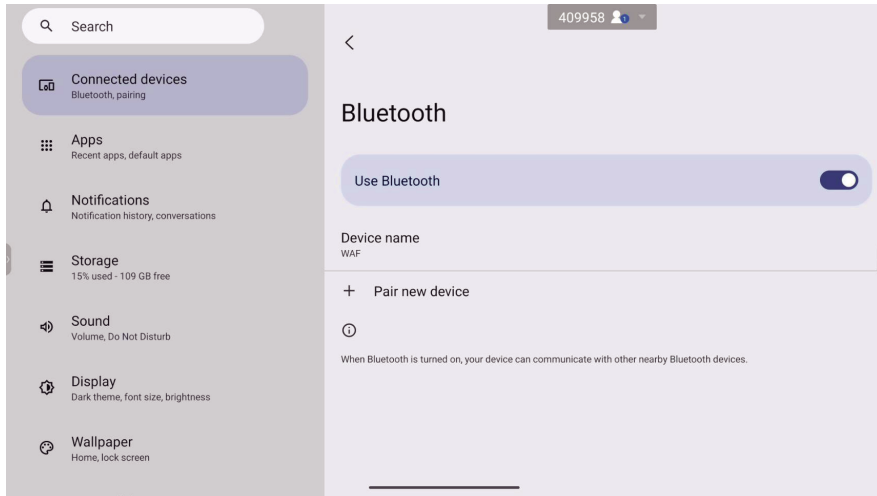

You can view the list of available nearby devices and connect to a Bluetooth device from the list. Then, you can configure the permission and type of the connected Bluetooth device.

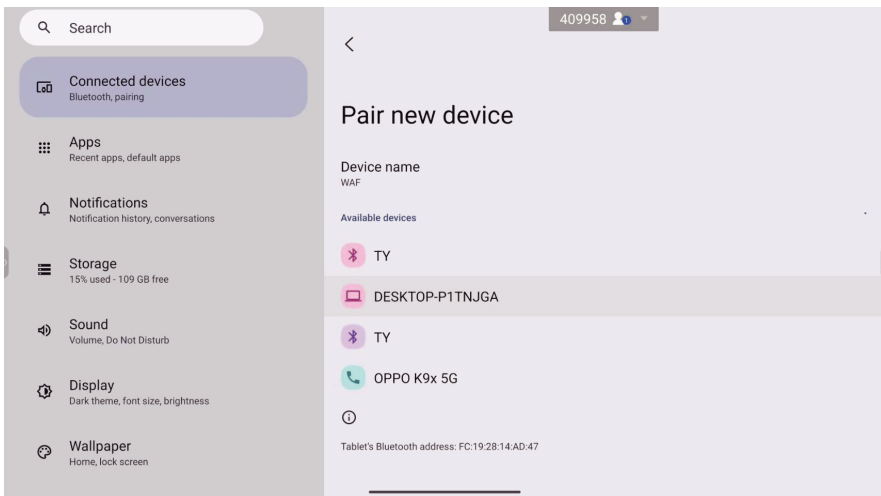

# VPN

You can set up a virtual private network (VPN) for VPN-based network access.

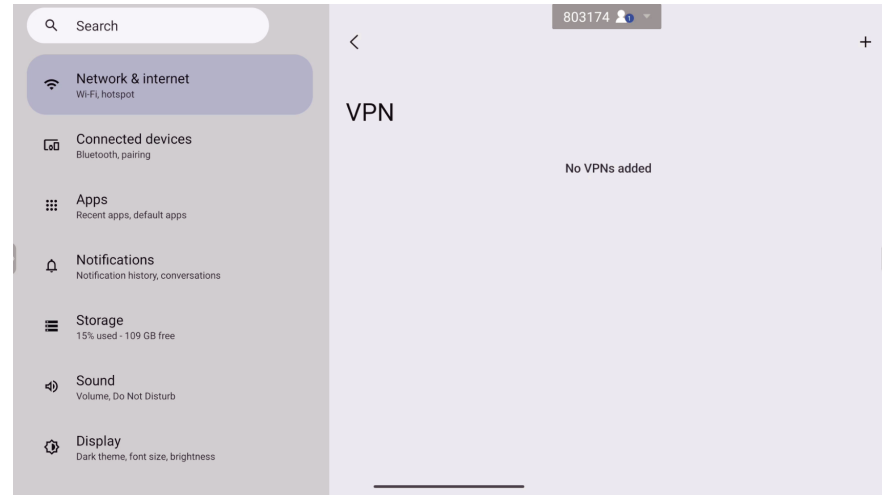

You can add a VPN profile based on your requirements.

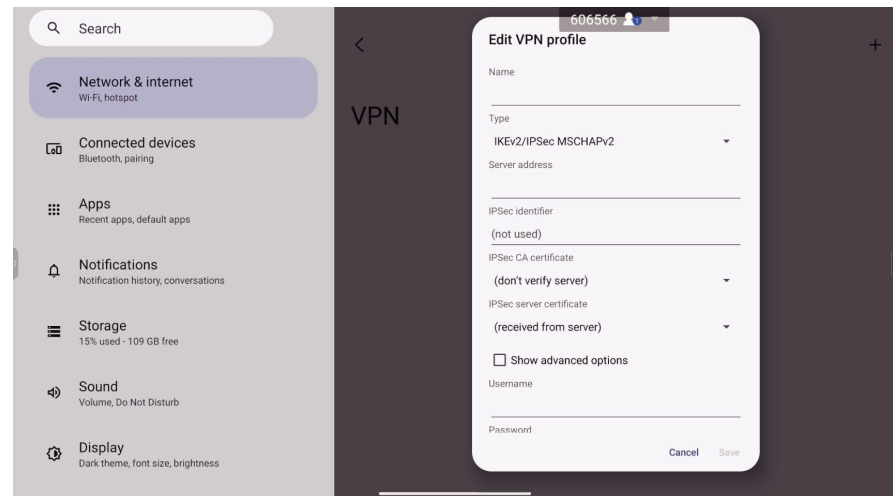

## Device

You can specify whether to toggle on the samba service that allows file transfer between a personal device and the current device.

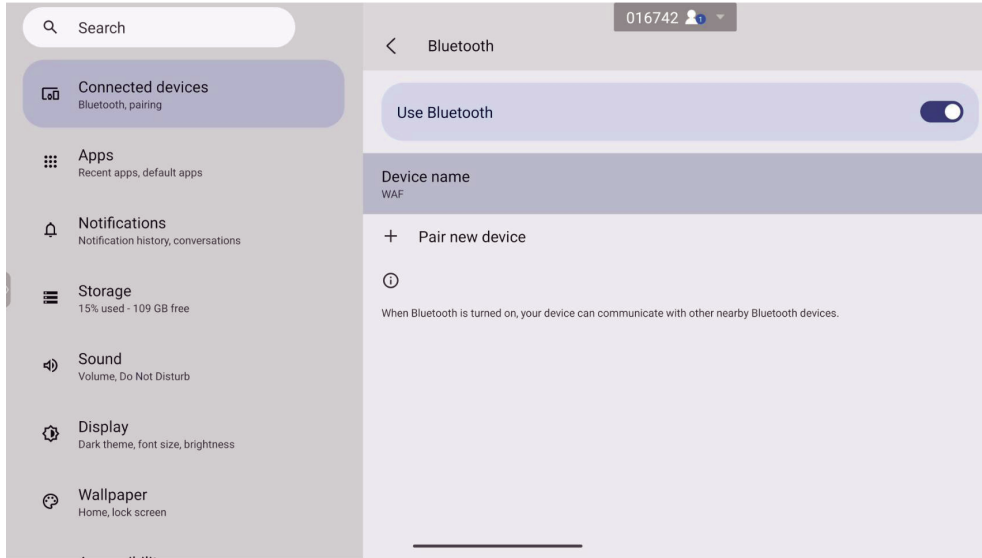

## Wallpaper

Select wallpaper sources including wallpapers with personalization, photo albums.

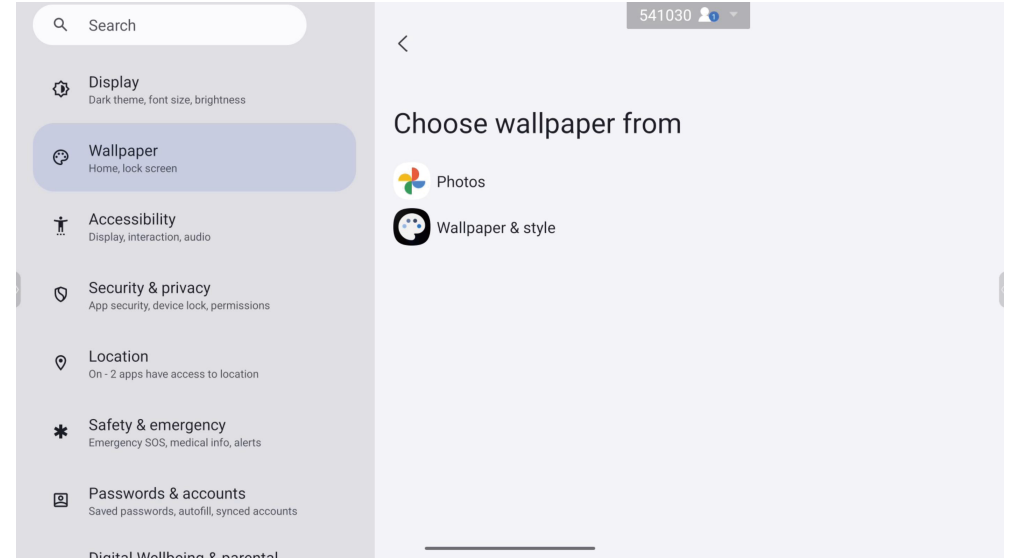

## Clock color&size

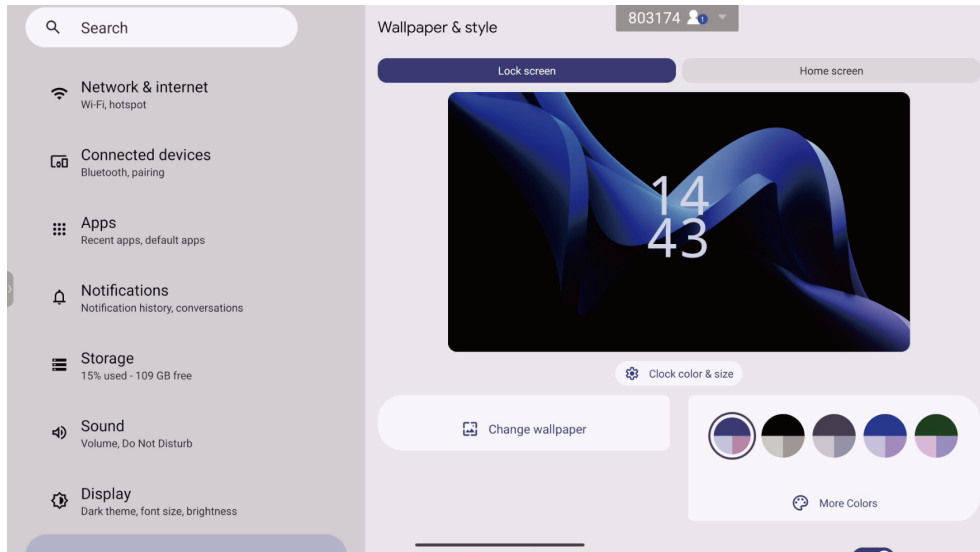

## Screen Saver

You can set the screen saver to **clock**, **colors**, or **landscape** and specify the time to start it. You can also preview the screen saver.

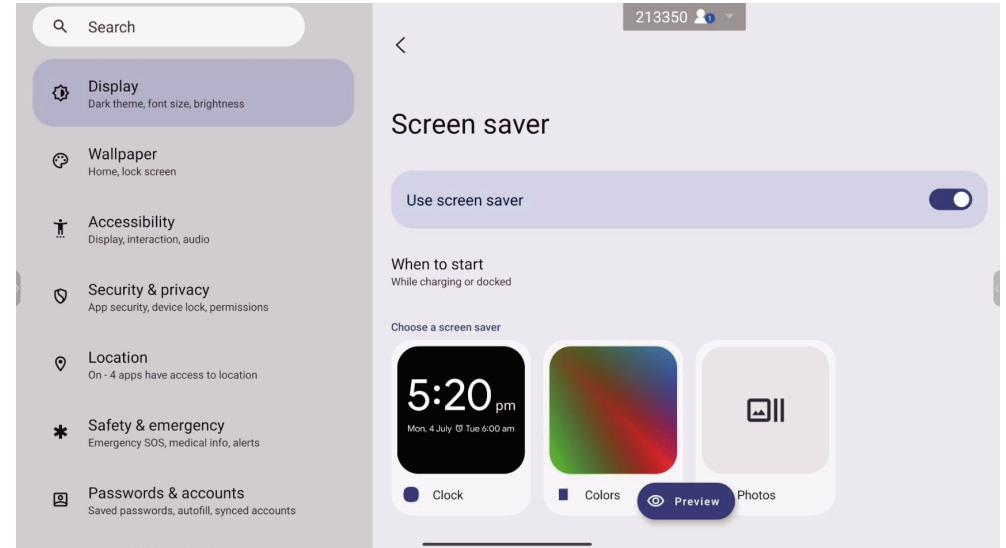

## Choose a Wallpaper

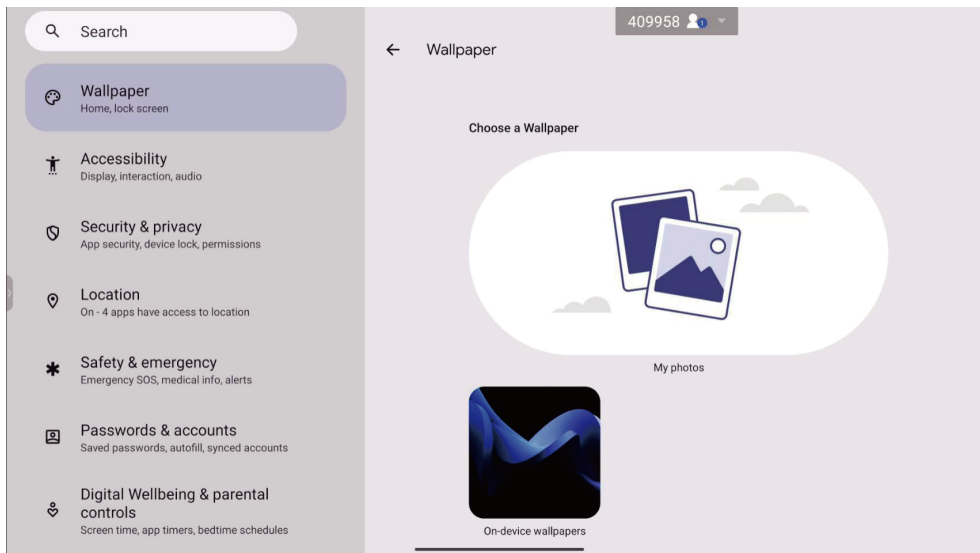

# Screenshot

Click to take a screenshot

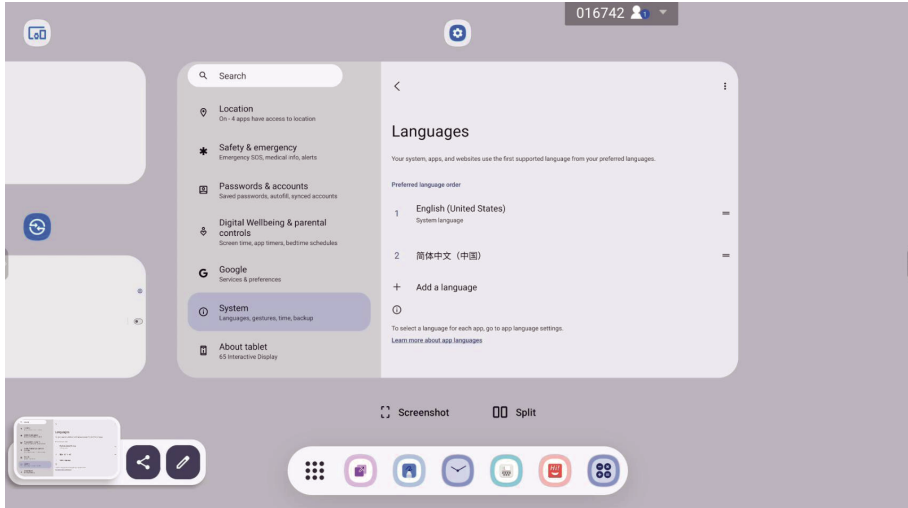

# Split Screen

Tap the app icon to view app info or split-screen operation

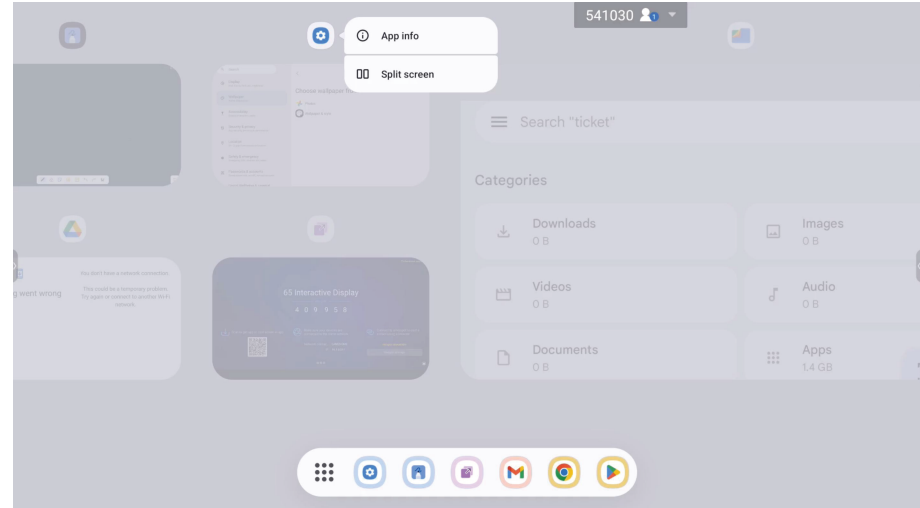

Then tap another app for split-screen operation

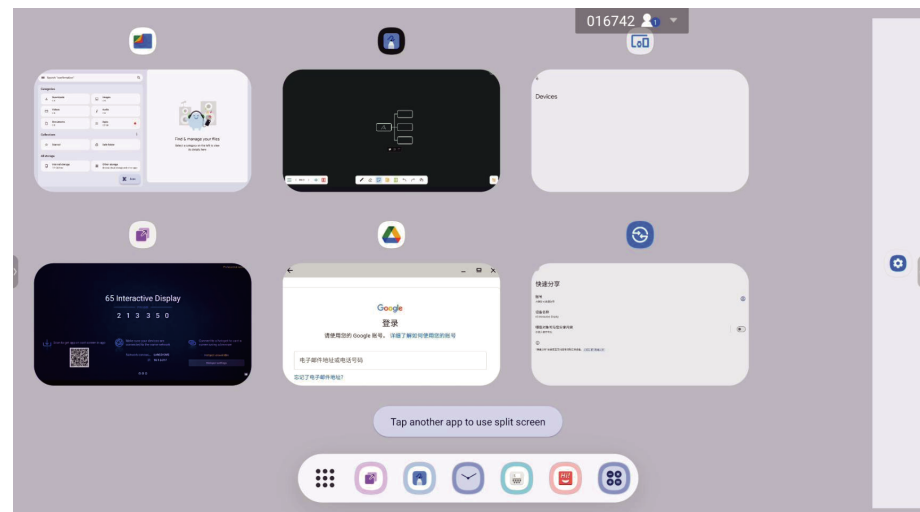

## Sidebar



Item	Description
1 <b>Annotaion</b>	Open Annotation tool.
2 <b>Signal Source</b>	To display the list of signal sources(the connected sources are highlighted), click to enter the corresponding channel.
3 <b>Tools</b>	At the top, you can click different tools to respond to the operation; in the center, you can directly adjust the sound and brightness of the all-in-one PC, clicking the button to the right of the sound to mute it, and clicking the button to the right of the brightness to turn on the auto-brightness. The bottom shows all the application functions, click once to open the corresponding application. Long press on the application with "Multi-window icon" can open the application in the form of free form.
4 <b>Device Setting</b>	Click to enter the settings for Display, Audio and General conditions.
5 <b>Settings</b>	Click to enter Android system settings.
6 <b>Multitasking</b>	Enter the system multitasking page, you can view the applications that are currently running in the background.
7 <b>Home</b>	Tap the home icon to quickly return to the home page. The current application can be retrieved in multitasking.
8 <b>Back</b>	Tap to return to the previous step of the operation, until you return to the home page or the starting position of the operation.

## Floating app

After clicking on the sidebar, then open the control panel. In the app list at the bottom, long press on the apps with blue corner mark in the upper right corner to open it in free window form.



It allows you to have multiple applications open in the foreground at the same time.

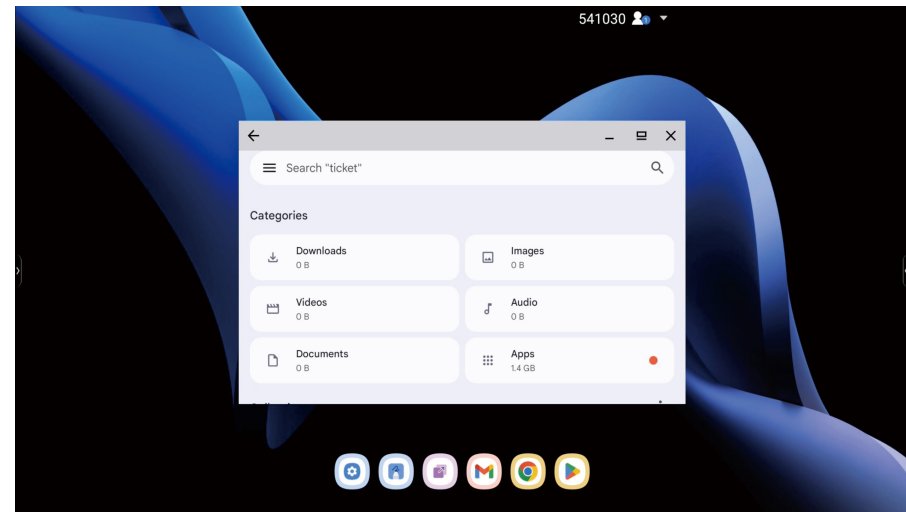

# Apps

In **Apps**, you can browse system apps and manage their permissions.

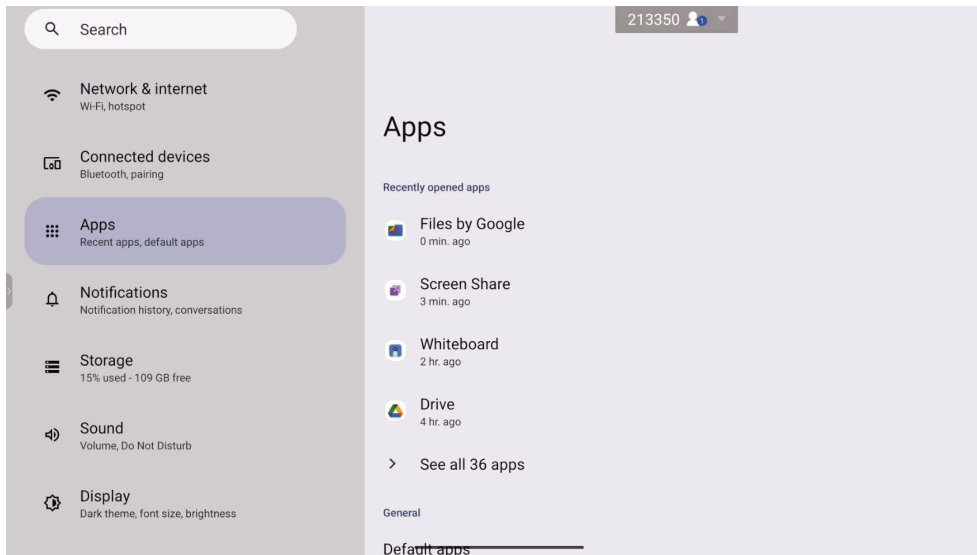

View recently opened apps with the option to open, deactivate, or force stop them, set notifications, app permissions, storage and cache, mobile data and WLAN, device usage time, battery usage for apps, choose to open supported links, make settings for idle apps with the option of whether to pause the activity of idle apps, and set whether to turn on Picture-in-Picture and other advanced options.

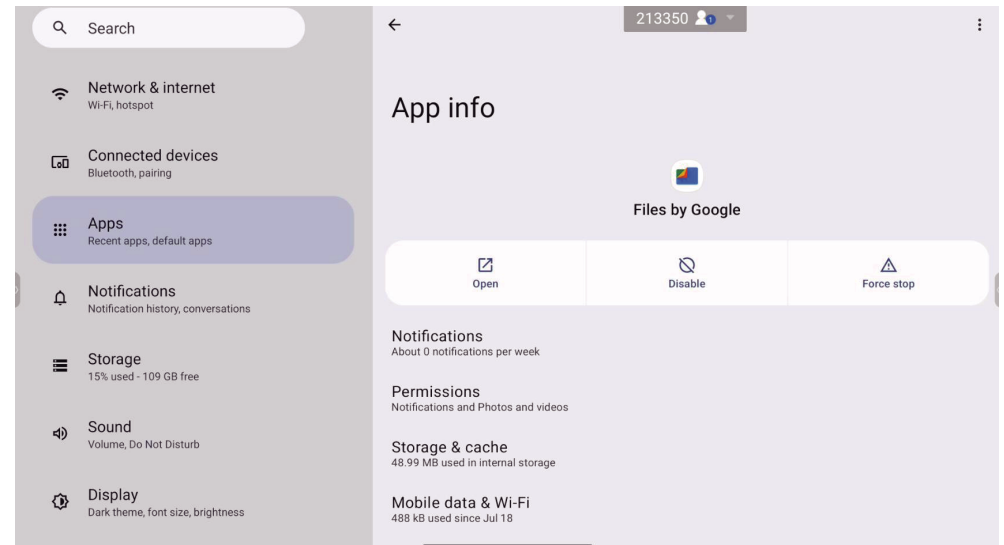

# System

System settings allow you to configure general system functions.

Specify the time zone basis for the automatic adjustment of the date and time.

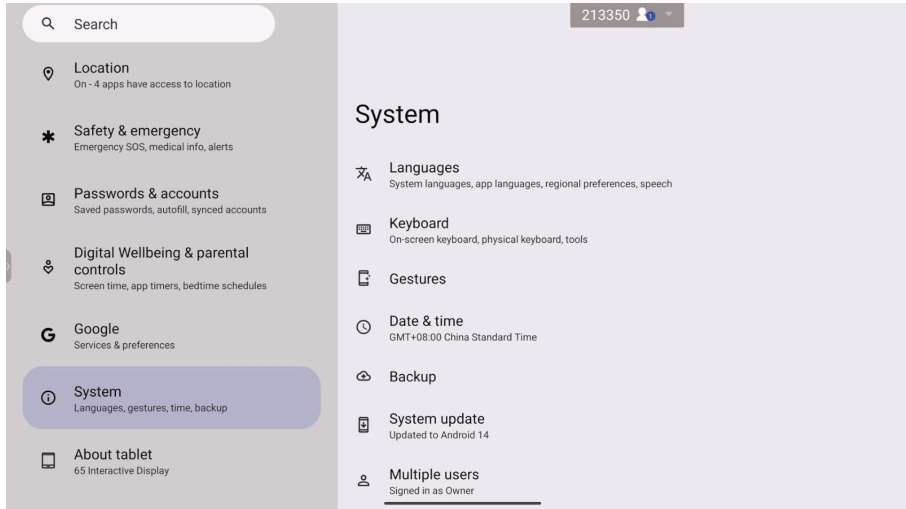

# Date & Time

You can specify the date and time format and the time zone of the system.

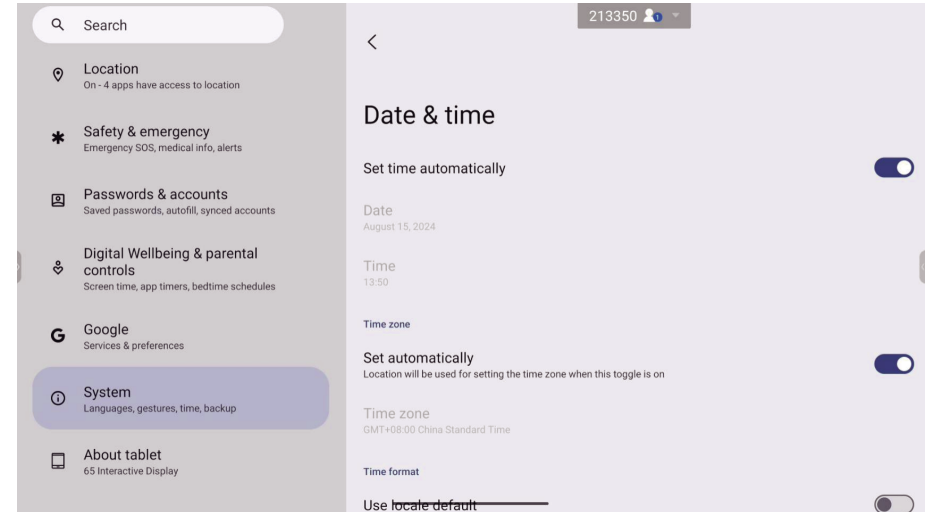

Item	Description
<b>Set time automatically</b>	Toggle on/off Automatic Date & Time. If you toggle off this option, you need to manually specify the date and time.
<b>Set automatically</b>	Specify the time zone. The time zone is the basis for the automatic adjustment of the date and time.
<b>Date Format</b>	Whether to use the default language region.
<b>Time Zone</b>	Toggle on/off Use 24-Hour Format.

# Language

You can adjust the system languages, apps languages, regional preferences. In system languages, you can add languages to your list and organize them according to preference.

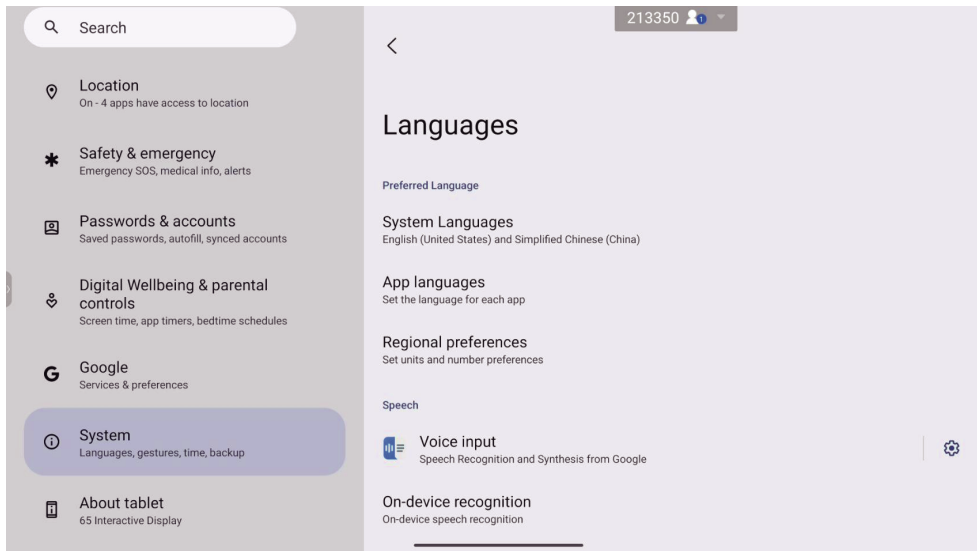

# Keyboard

Setting up the on-screen keyboard and displaying the on-screen keyboard.

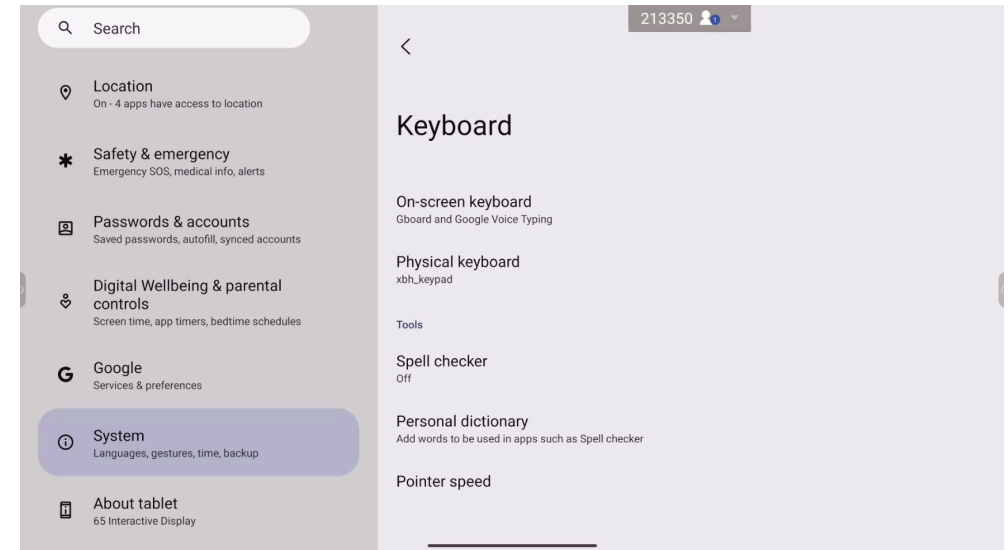

## Storage

You can view the internal storage space and the space occupied by different types of files. Tap on free up space to jump to the files.

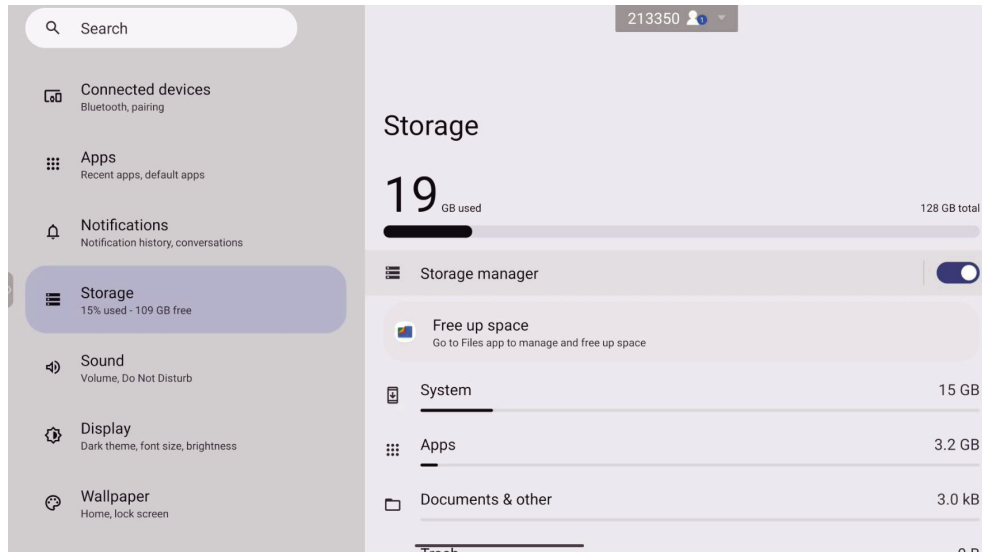

## Files

You can find and manage your files in different categories and all storage space.

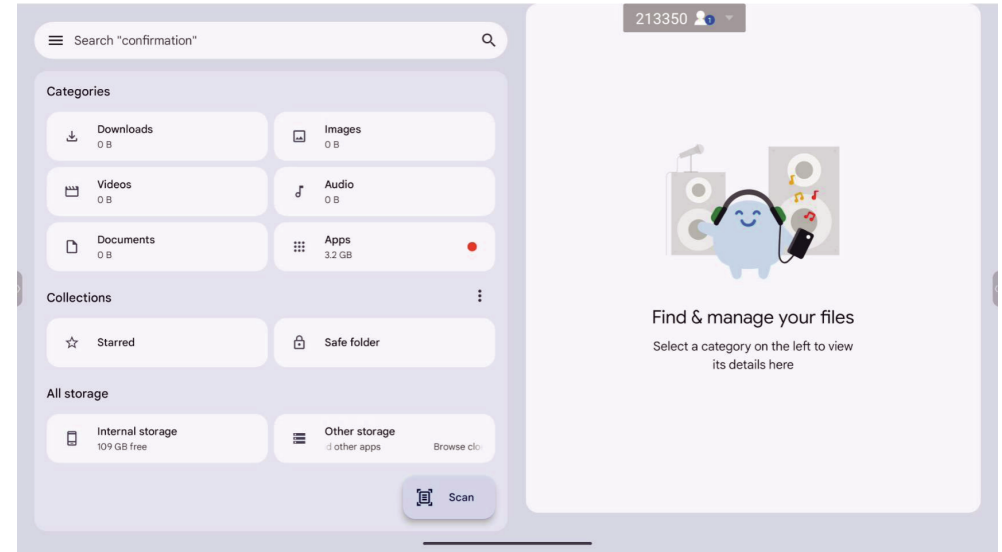

# Software Update

Settings → System → System Update → ENTER

The **System Update** lets you upgrade your product software to the latest version.

-Be careful not to turn off the power until the upgrade is complete. The product will turn off and on automatically after completing the software upgrade.

-When you upgrade software, all video and audio settings you have made will return to their default settings. We advise you to write down your settings so that you can easily reset them after the upgrade.

**Step 1:** Select the system and click on system upgrade.

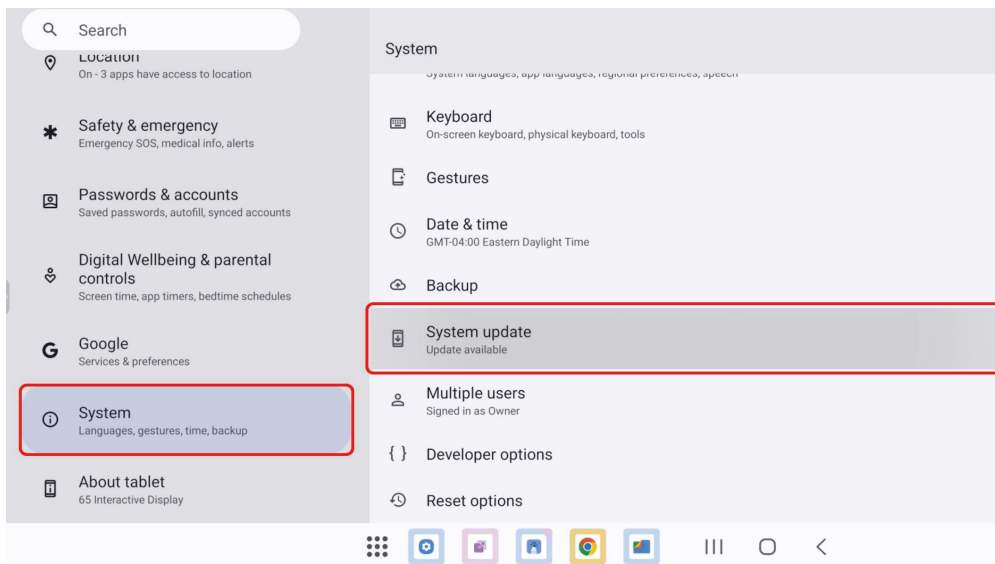

**Step 2:** Click to check for update.

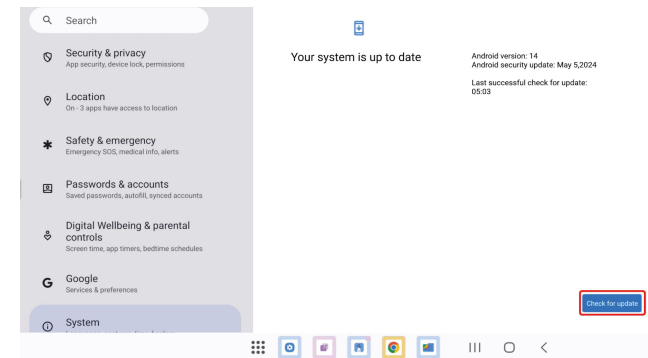

**Step 3:** Waiting for checking update.

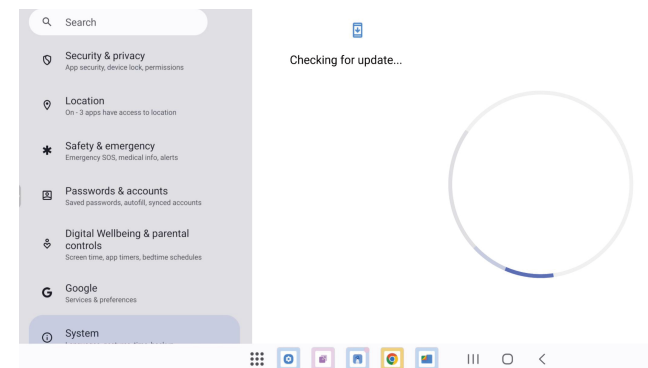

**Step 4:** Installing system update.

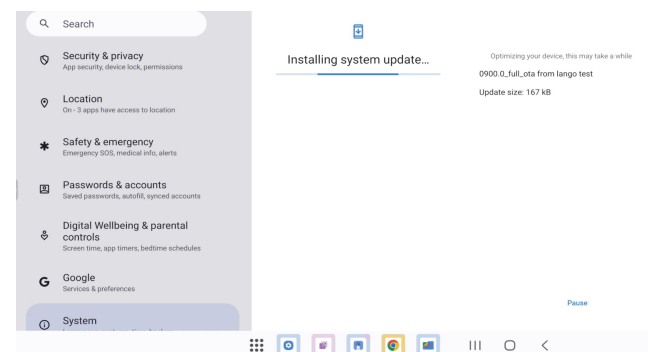

# Lock Screen

## Password

The lock screen password is used to prevent unauthorized operations.

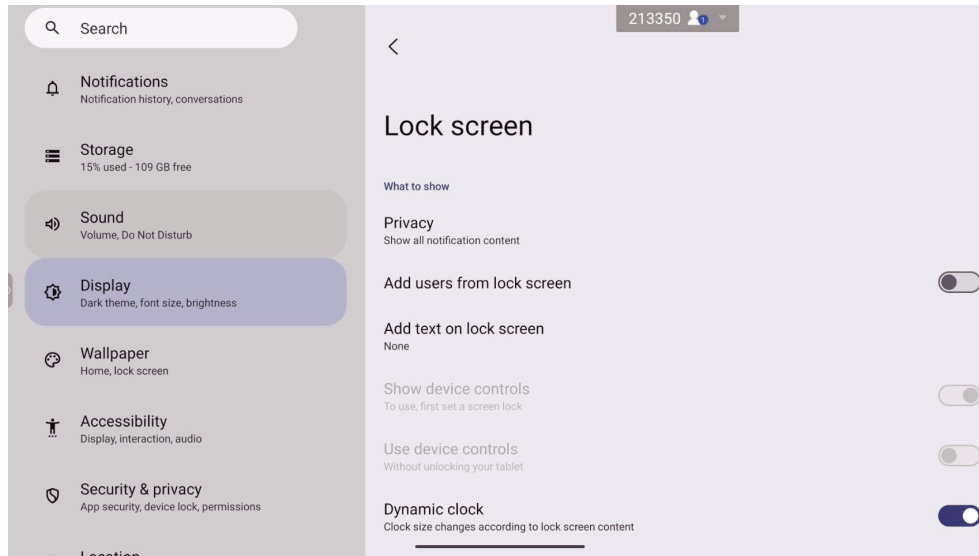

# Security

In the security settings, you can view the configured credentials in the system, including trusted and user credentials. Connecting to specific encrypted networks, such as TLS or PEAP requires a specific credential for validation.

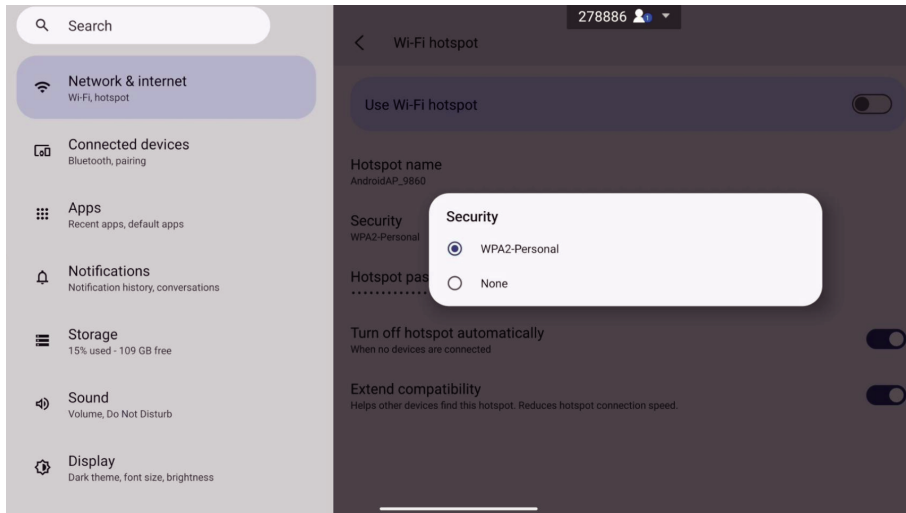

# Credential list

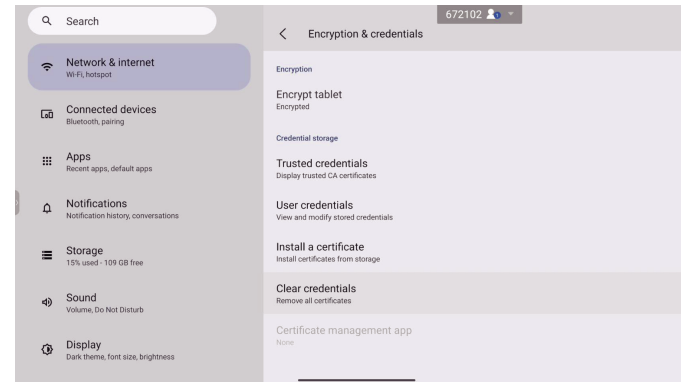

The following window pops up during credential clearing.

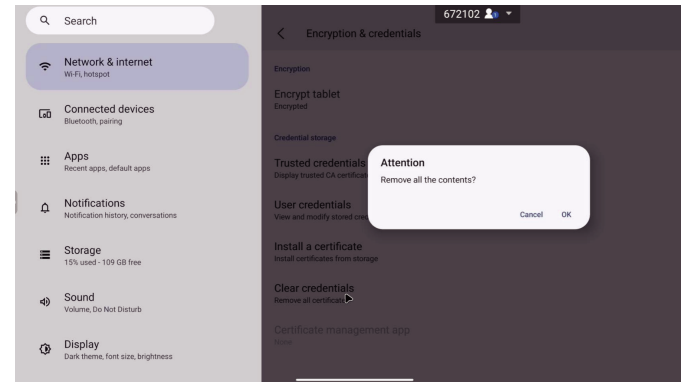

# About

You can view basic system information.

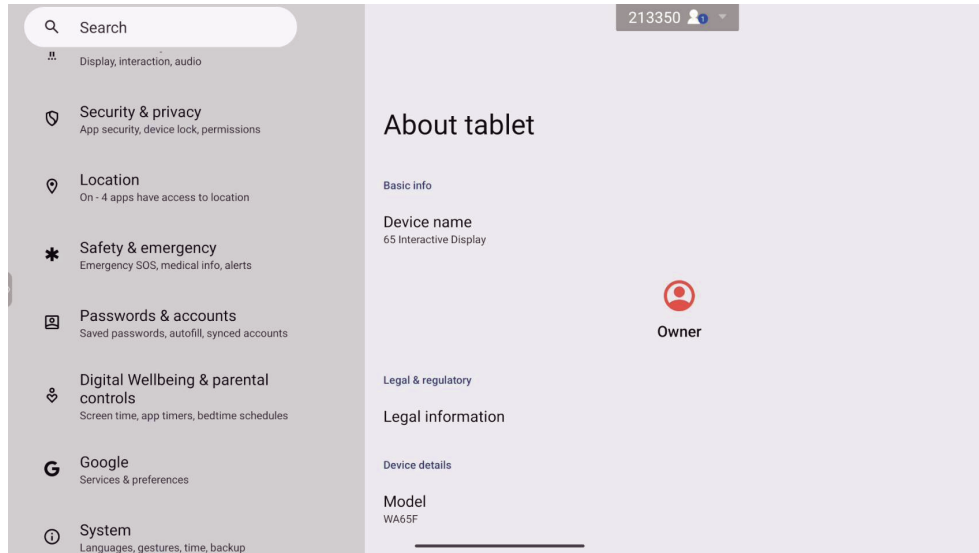

# Device Setting

## Display

Adjust image display settings.



Item	Description
<b>Display</b>	Click to enter the display settings.
<b>Picture Mode</b>	Image mode includes four modes: Standard, Bright, Brilliant and Custom which can adjust Scale, Contrast, Tone and Sharpness respectively.
<b>Color temperature mode</b>	Color temperature modes include Normal, Cold, Warm, and Filter.

## Audio

Supports 5 sound modes: Standard, Conference room, Cinema, classroom and Custom. And the use of ARC output can be turned on.

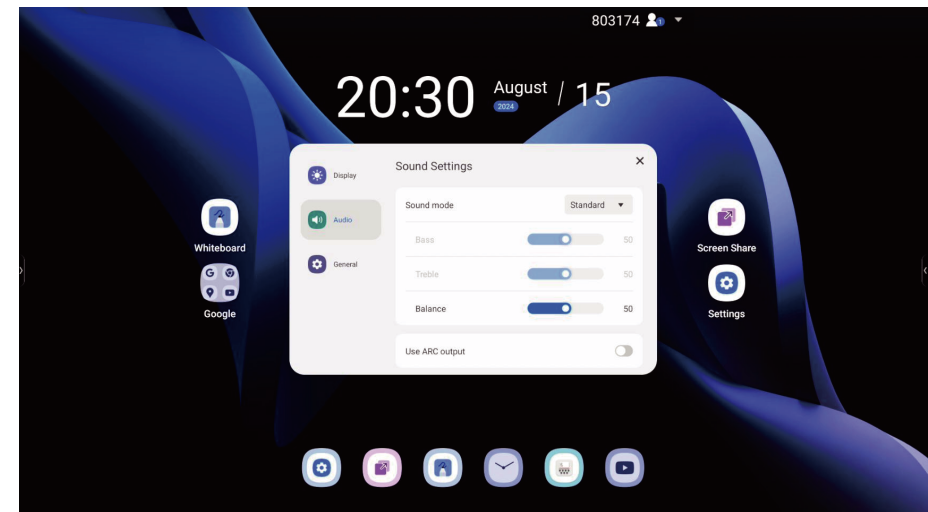

Item	Description
<b>Audio</b>	Click to enter sound settings.
<b>Sound mode</b>	Sound modes include Standard, Meeting Room, Cinema, Classroom and Custom, with adjustments for Bass, Treble and Balance.
<b>Use ARC output</b>	Turn it on to amplify sound, turn it off to use the device's own output channels.

# General

Adjust general settings.



Parts	Description
<b>General</b>	Click to enter General Settings.
<b>Power-on mode</b>	Power-up mode includes two modes: power-on and power-on stand by.
<b>OPS power-on mode</b>	Tap OPs power-up mode to confirm whether it is on or not.
<b>Boot source</b>	You can chose Memory channels, ANDROID, OPS, HDMI1, HDMI2 and UsB-C as boot source.
<b>Auto Source switching</b>	You can choose to turn on, user confirmation, or turn off auto source switching.
<b>Power on Source Setting</b>	Click to enable or disable power on source.

# Chapter 05

## Troubleshooting guide







### Problems and solutions

✎ Test your product as follows before calling Samsung Customer Service Center. If the problem persists, contact Samsung Customer Service Center.

Source window (HDMI) issue	
Blank spaces are found on all four sides of the screen when an HDMI cable is connected to the product and PC.	The blank spaces are not caused by the product.
	Blank spaces on the screen are caused by the PC or graphics card. To resolve the problem, adjust the screen size in the HDMI settings for the graphics card.
	If the graphics card settings menu does not have an option to adjust the screen size, update the graphics card driver to the latest version. (Please contact the graphics card or computer manufacturer for further details about how to adjust the screen settings.)
The images on the screen look distorted.	Check the connected cable. Compatibility is not guaranteed if you use a cable that has not been supplied by Samsung.
The screen is not clear. The screen is blurry.	Set the resolution and frequency to the recommended level.
The screen appears unstable and shaky.	Check that the resolution and frequency of the PC and graphics card are set within a range compatible with the product. Then, change the screen settings if required by referring to ' <a href="#">Preset timing modes</a> '.
There are shadows or ghost images left on the screen.	
White does not really look white.	Go to <b>Picture</b> and adjust the <b>White Balance</b> settings.
The product will turn off automatically.	Make sure the power cable is connected properly to the product and power outlet.

Source window (HDMI) issue	
The screen display does not look normal.	Encoded video content may cause the display to appear corrupted in scenes featuring fast moving objects such as in a sports event or action video.
	Low signal level or low picture quality may cause the display to appear corrupted. This does not mean the product is defective.
	A mobile device within a distance of one-meter radius may cause static on analogue and digital products.
The brightness and color do not look normal.	From the quick settings, select <b>Display</b> → <b>Picture Mode</b> to adjust the mode to standard, bright, brilliant or custom.
The display looks unstable and then freezes.	The screen may freeze when a resolution other than the recommended resolution is used or if the signal is not stable. To resolve the issue, change the PC resolution to the recommended resolution.
The screen cannot be displayed in full screen.	If the source window is set to full screen mode while in portrait orientation, a black bar appears at both the top and bottom. Change to landscape orientation, and then switch the Source window to full screen mode.

Sound issue	
There is no sound.	Check the volume.
The volume is too low.	Adjust the volume.
	If the volume is still low after turning it up to the maximum level, adjust the volume on your PC sound card or software programme.
Video is available but there is no sound.	If a HDMI cable is connected, check the audio output settings on the PC.
	If a source device is used <ul style="list-style-type: none"> <li>• Check the audio output settings for the source device. (For example, if your monitor is connected to HDMI, you may need to change the audio option of your video output device to HDMI.)</li> </ul>
	Reconnect the power cable to the device and then reboot the device.
There is static coming from the speakers.	Low signal level can cause corrupted sound.
There is audible sound when the volume is muted.	Audio settings for main speakers are separate from the internal speakers on the product. Changing or muting the volume on the product does not affect an external amplifier(decoder).

Touch function issues	
The icons can be selected but does not allow drawing.	Use the provided product-specific pen.
Touching does not work when HDMI connection is used.	<p>Check whether the TOUCH  port on the product is connected to a USB port on the PC using the supplied USB cable.</p> <ul style="list-style-type: none"> <li>WA65F/WA75F/WA86F <ul style="list-style-type: none"> <li> HDMI  1 → TOUCH  on the front of the product</li> <li> HDMI  2 → TOUCH  on the rear of the product</li> </ul> </li> </ul>
When two pens are used, display has difficulty recognizing them.	Make sure that there is enough space between the two pens at multi-touching.
There is a screen touch malfunction such as slow or inaccurate responding.	Make sure that there are no foreign substances on the screen surface.
	Check whether the screen is broken.
	Make sure that the product is not exposed to direct sunlight.
	When the product is turned on after turning off, do not tap the screen because touch calibration is performed for 5 seconds.
Other issue	
The product smells like plastic.	The plastic smell is normal and disappears over time.
Small particles are found on the edges of the product.	The particles are part of the product design. The product is not defective.
When I try to change the PC resolution, a message "The defined resolution is not currently supported." appears.	<p>The message "The defined resolution is not currently supported." appears if the input source resolution exceeds the maximum resolution of the product.</p> <p>To resolve the issue, change the PC resolution to a resolution supported on the product.</p>
There is no sound from the speakers in HDMI mode when a DVI-HDMI cable is connected.	DVI cables do not transmit sound data.
There is no sound in HDMI mode.	Displayed picture colors may not look normal. Video or sound may not be available. This can occur if a source device that only supports an older version of the HDMI standard is connected to the product.

# Chapter 06

## Specifications

### General

Model Name		WA65F	WA75F	WA86F
Panel	Size	65 CLASS (64.5 inches / 163.9 cm)	75 CLASS (74.5 inches / 189.3cm)	86 CLASS (85.6 inches / 217.4cm)
	Display area	1428.48 mm (H) x 803.52 mm (V)	1649.664 mm (H) x 927.936 mm (V)	1895.04 mm (H) x 1065.96 mm (V)
Synchronization (Panel Spec)	Horizontal Frequency	135 kHz		
	Vertical Frequency	60 Hz		
Resolution	Optimum resolution	3840 x 2160		
	Maximum resolution			
Power Supply		AC100-240V~ 50/60Hz Refer to the label at the back of the product as the standard voltage can vary in different countries.		
Environmental considerations	Operating	Temperature : 32 °F – 104 °F (0 °C – 40 °C) * For installing the enclosure, keep the internal temperature at 104 °F (40 °C) or below. Humidity : 10% – 80%, non-condensing		
	Storage	Temperature : -4 °F – 113 °F (-20 °C – 45 °C) Humidity : 5% – 95%, non-condensing * Applicable before the product package is unpacked.		

 **Horizontal Frequency:**  
The time required to scan a single line from the left to the right side of the screen is called a horizontal cycle. The reciprocal number of a horizontal cycle is called horizontal frequency. Horizontal frequency is measured in kHz.

 **Vertical Frequency:**  
The product displays a single image multiple times per second (like a fluorescent light) to display what the viewer sees. The rate of a single image being displayed repeatedly per second is called vertical frequency or refresh rate. Vertical frequency is measured in Hz.

- 
- ✎ Due to the nature of the manufacturing of this product, approximately 1 pixel per million (1ppm) may appear brighter or darker on the panel. This does not affect product performance.
  - ✎ This product can be set to only one resolution for each screen size to obtain the optimum picture quality due to the nature of the panel. Using a resolution other than the specified resolution may degrade the picture quality. To avoid this, it is recommended that you select the optimum resolution specified for your product.
  - ✎ For detailed device specifications, visit the Samsung website.

## Preset timing modes

The screen will automatically be adjusted if a signal that belongs to the following standard signal modes is transmitted from your PC. If the signals transmitted from the PC differ from the standard mode, the screen may not be displayed. In such a case, change the settings as shown in the following table by referring to the graphics card user manual.

No.	Signal timing name	Reference	clock	Hf	Vf	HDMI	VGA	TypeC
			[MHz]	[KHz]	[Hz]			
1	720*400 @70Hz	IBM	28.322	31.788	70	/	Y	/
2	640*480 @60Hz	VESA	25.18	31.469	59.94	Y	Y	Y
3	800*600 @56Hz	VESA	36	35.156	56.25	/	Y	Y
4	800*600 @60Hz	VESA	40	37.879	60.317	Y	Y	Y
5	1024*768 @60Hz	VESA	65	48.363	60.004	Y	Y	Y
6	1280*768 @60Hz(RB)	CVTRB	68.25	47.396	59.995	Y	Y	Y
7	1280*768 @60Hz	VESA	79.5	47.776	59.87	Y	Y	Y
8	1280*800 @60Hz	VESA	83.5	49.702	59.81	Y	Y	Y
9	1280*960 @60.000Hz	VESA	108	60	60	Y	Y	Y
10	1280*1024 @60Hz	VESA	108	63.981	60.002	Y	Y	Y
11	1360*768 @60Hz	VESA	85.5	47.712	60.015	Y	Y	Y
12	1440*900 @60Hz(RB)	CVTRB	88.75	55.469	59.901	Y	Y	Y
13	1440*900 @60Hz	CVT	106.5	55.935	59.887	Y	Y	Y
14	1680*1050 60Hz	VESA	146.25	65.29	59.954	Y	Y	Y
15	1920*1080 60Hz	CEA	148.5	67.5	60	Y	Y	Y
16	640*480P594:3	CEA	25.175	31.469	59.94	/	/	Y
17	640*480P604:3	CEA	25.2	31.5	60	/	/	Y
18	720*480P604:3	CEA	27.027	31.5	60	/	/	Y
19	720*480P6016:9	CEA	27.027	31.5	60	/	/	Y
20	1280*720P5916:9	CEA	74.175	44.955	59.939	/	/	Y
21	1280*720P6016:9	CEA	74.25	45	60	/	/	Y
22	1440*480P604:3	CEA	54.054	31.5	60	/	/	Y
23	1440*480P5916:9	CEA	54	31.469	59.94	/	/	Y
24	1440*480P6016:9	CEA	54.054	31.5	60	/	/	Y
25	1920*1080P5916:9	CEA	148.35	67.432	59.939	/	/	Y
26	1920*1080P6016:9	CEA	148.5	67.5	60	/	/	Y

No.	Signal timing name	Reference	clock	Hf	Vf	HDMI	VGA	TypeC
			[MHz]	[KHz]	[Hz]			
27	720*576P504:3	CEA	27	31.25	50	/	/	Y
28	720*576P5016:9	CEA	27	31.25	50	/	/	Y
29	1280*720P5016:9	CEA	74.25	37.5	50	/	/	Y
30	1440*576P5016:9	CEA	54	31.25	50	/	/	Y
31	1920*1080P5016:9	CEA	148.5	56.25	50	/	/	Y
32	1920*1080P2316:9	CEA	74.175	26.973	23.976	/	/	Y
33	1920*1080P2416:9	CEA	74.25	27	24	/	/	Y
34	1920*1080P2516:9	CEA	74.25	28.125	25	/	/	Y
35	1920*1080P2916:9	CEA	74.175	33.716	29.97	/	/	Y
36	1920*1080P3016:9	CEA	74.25	33.75	30	/	/	Y
37	720(1440)*480i	CEA	27	15.734	59.939	Y	/	/
38	480p 59Hz	CEA	27	31.469	59.94	Y	/	/
39	480p 60Hz	CEA	27.027	31.5	60	Y	/	/
40	720(1440)*576i	CEA	27	15.625	50	Y	/	/
41	576p 50Hz	CEA	27	31.25	50	Y	/	/
42	720p 60Hz	CEA	74.25	45	60	Y	/	/
43	720p 59Hz	CEA	74.176	44.955	59.94	Y	/	/
44	720p 50Hz	CEA	74.25	37.5	50	Y	/	/
45	1080i 60Hz	CEA	74.25	33.75	60	Y	/	/
46	1080i 59Hz	CEA	74.176	33.716	59.94	Y	/	/
47	1080i 50Hz	CEA	74.25	28.125	50	Y	/	/
48	1080p 60Hz	CEA	148.5	67.5	60	Y	/	/
49	1080p 50Hz	CEA	148.5	56.25	50	Y	/	/
50	1080p 30Hz	CEA	74.25	33.75	30	Y	/	/
51	1080p 29Hz	CEA	74.176	33.716	29.97	Y	/	/
52	1080p 25Hz	CEA	74.25	28.125	25	Y	/	/
53	1080p 24Hz	CEA	74.25	27	24	Y	/	/
54	1080p 23Hz	CEA	74.176	26.973	23.976	Y	/	/
55	3840*2160 60Hz	CEA	594	135	60	Y	/	Y
56	3840*2160 50Hz	CEA	594	112.5	50	Y	/	Y
57	3840*2160 30Hz	CEA	297	67.5	29.97	Y	/	Y
58	3840*2160 25Hz	CEA	297	56.25	25	Y	/	Y
59	3840*2160 24Hz	CEA	297	54	23.982	Y	/	Y

# Chapter 07

## Appendix

### Responsibility for the pay service (Cost to customers)

 When the service is requested, in spite of in warranty, we may charge you for a visit from a service technician in the following cases.

#### Not a product defect

Cleaning of the product, Adjustment, Explanation, Re-installation and etc.

- If a service technician is requested to give instructions on how to use product or simply adjusts options without disassembling product.
- If a defect is caused by external environmental factors (Internet, Antenna, Wired Signal, etc.)
- If a product is reinstalled or devices are connected additionally after installing the purchased product for the first time.
- If a product is reinstalled to move to a different spot or to move to a different house.
- If the customer requests instructions on how to use another company's product.
- If customer requests instructions on how to use the network or another company's programme.
- If customer requests software installation and setup for the product.
- If a service technician removes/cleans dusts or foreign materials inside of the product.
- If customer requests an installation additionally after purchasing a product through home-shopping or online.

### A product damage caused by customer's fault

Product damage caused by customer's mishandling or wrong repair

If a product damage is caused by;

- External impact or drop.
- Use of supplies or separately sold product unspecified by Samsung.
- Repair from a person besides an engineer of outsourcing service company or partner of Samsung Electronics Co., Ltd.
- Remodeling or repairing the product by customer.
- Using it with incorrect voltage or non-authorized electrical connections.
- Not following the "cautions" in User Manual.

#### Others

- If product fails by natural disaster. (lightning, fire, earthquake, flood damage, etc)
- If consumable components are all used up. (Battery, Toner, Fluorescent lights, Head, Vibrator, Lamp, Filter, Ribbon, etc.)

 If customer requests a service in case the product has no defect, service fee may be charged. So please read user Manual first.

---

## Prevention of afterimage burn-in

### What is afterimage burn-in?

Afterimage burn-in should not occur when the panel is operating normally. Normal operation refers to a continuously changing video pattern. If the panel displays a fixed pattern for an extended period of time a slight voltage difference may occur between the electrodes in pixels that control the liquid crystals.

Such a voltage difference between electrodes increases with time and makes the liquid crystals thinner. When this occurs, a previous image can remain on the screen when the pattern changes.

-  This information is a guide to prevent afterimage burn-in. viewing a fixed screen for an extended period of time may cause afterimage burn-in. This problem is not included in warranty.

### Recommended prevention practices

Viewing a fixed screen for an extended period of time may cause afterimage burn-ins or smudges. Turn off the product when it is not used for a long time, activate the Power Saving mode, or run a moving screen saver.

## Licence



The terms HDMI and HDMI High-Definition Multimedia Interface, and the HDMI Logo are trademarks or registered trademarks of HDMI Licensing Administrator, Inc. in the United States and other countries.

---

### Open Source Licence Notice

In the case of using open source software, Open Source Licences are available on the product menu. For information on the Open Source Licence Notice, contact Samsung Open Source (<http://opensource.samsung.com>).

---

---

## Low Blue Light

Low Blue Light (software solution) filters out blue light to protect your eyes by adjusting how much blue light is shown:

1. To open blue light setting: on an device home screen, swipe up from the bottom
2. In the middle of “General Setting”, the function low blue light is called “Eye Care”.
3. Tap the item “Eye Care” to enable/disable low blue light.

## Tips for eye health

Eye exercises can help minimize eye strain. Slowly roll your eyes to the up, down, left and right. Repeat as many times as needed.

When viewing screens for extended periods, it is recommended to take periodic breaks from viewing. Short breaks of at least 10 minutes are recommended after one (1) hour of continuous viewing.

While taking breaks, users can further reduce eye strain and dryness by focusing on objects that are further away from them for 10-15 seconds, then gaze at something up close for 10-15 seconds. Repeat this up to 10 times.

This exercise reduces the risk of your eyes’ focusing ability to “lock up” after prolonged computer work.

## ENERGY STAR

ENERGY STAR is a U.S. Environmental Protection Agency voluntary program that helps businesses and individuals save money and protect our climate through superior energy efficiency. Products that earn the ENERGY STAR prevent greenhouse gas emissions by meeting strict energy efficiency criteria or requirements set by the U.S. Environmental Protection Agency. The following logo appears on all ENERGY STAR-certified models:

This product qualifies for ENERGY STAR in the “Standard mode” setting and this is the setting in which power savings will be achieved. Changing the Standard mode picture settings or enabling other features will increase power consumption that could exceed the limits necessary to qualify for ENERGY STAR rating. Refer to EnergyStar.gov for more information on

