

# UltraMAX TURBO TOOL Instructions

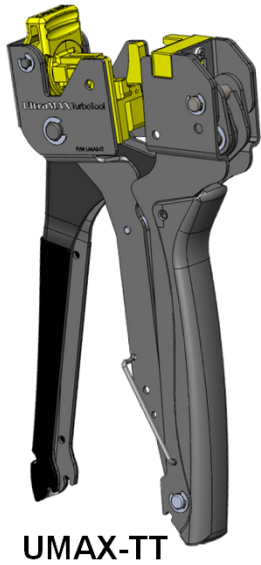

UMAX-TT

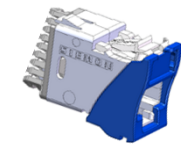

Hybrid

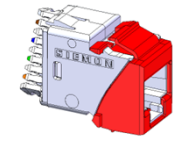

Keystone

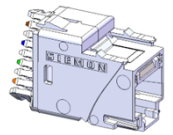

Panel mount

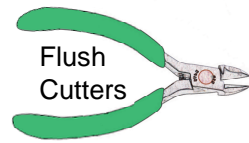

Flush Cutters



Flat Screwdriver  
(Phillips – optional for cutting die replacement)

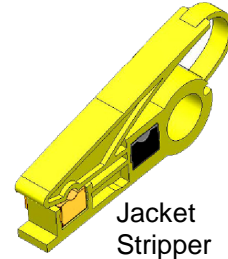

Jacket Stripper



P/N: PG2-U

UltraMAX Palm guard insert (optional)

## Additional Tools

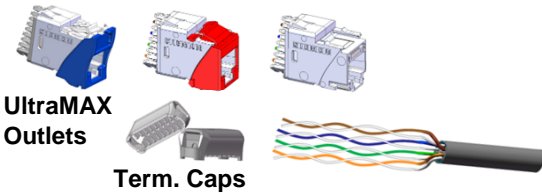

UltraMAX Outlets

Term. Caps



Reference UltraMAX outlet termination instructions for cable prep and lacing >>



1

Inspect for proper lacing

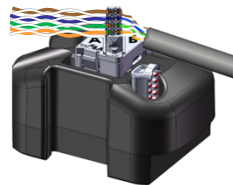

Keep fingers away from blade

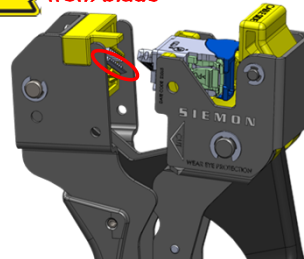

2

Swing open tool lever to "outlet loading position"

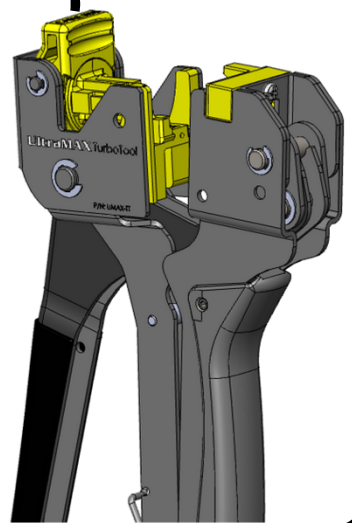

Cable Side Cut Side

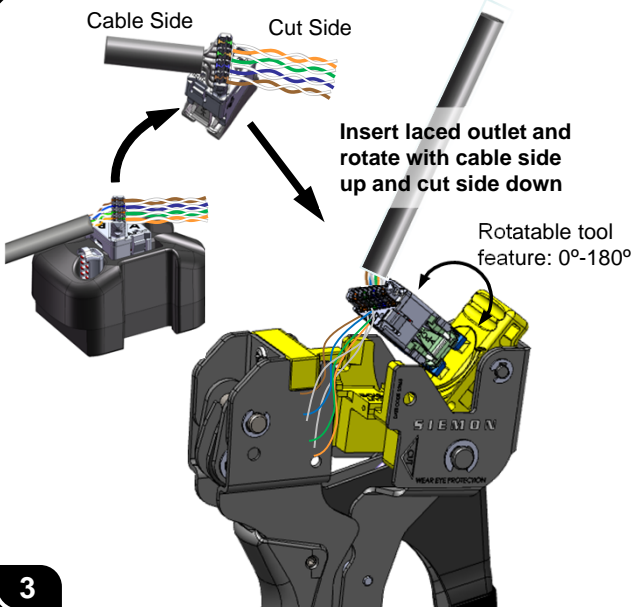

Insert laced outlet and rotate with cable side up and cut side down

Rotatable tool feature: 0°-180°

3

Cable Side

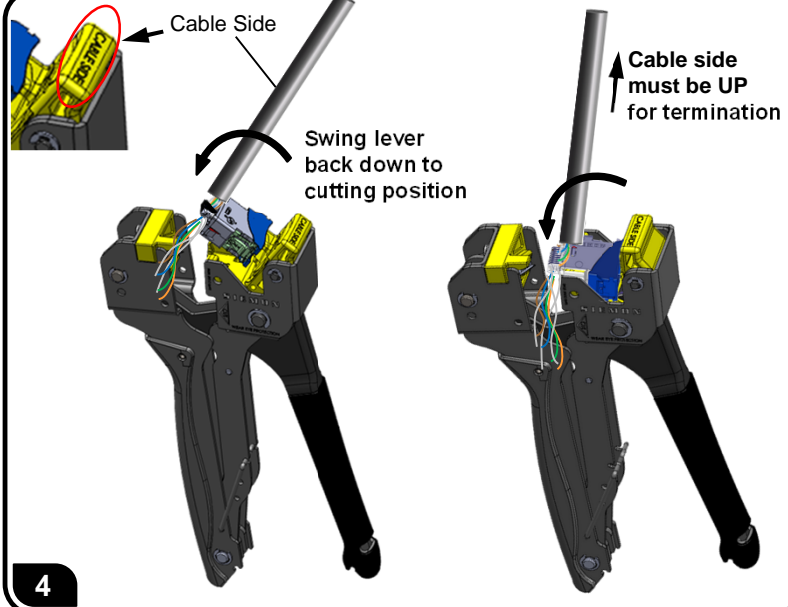

Swing lever back down to cutting position

Cable side must be UP for termination

4

# UltraMAX TURBO TOOL Instructions

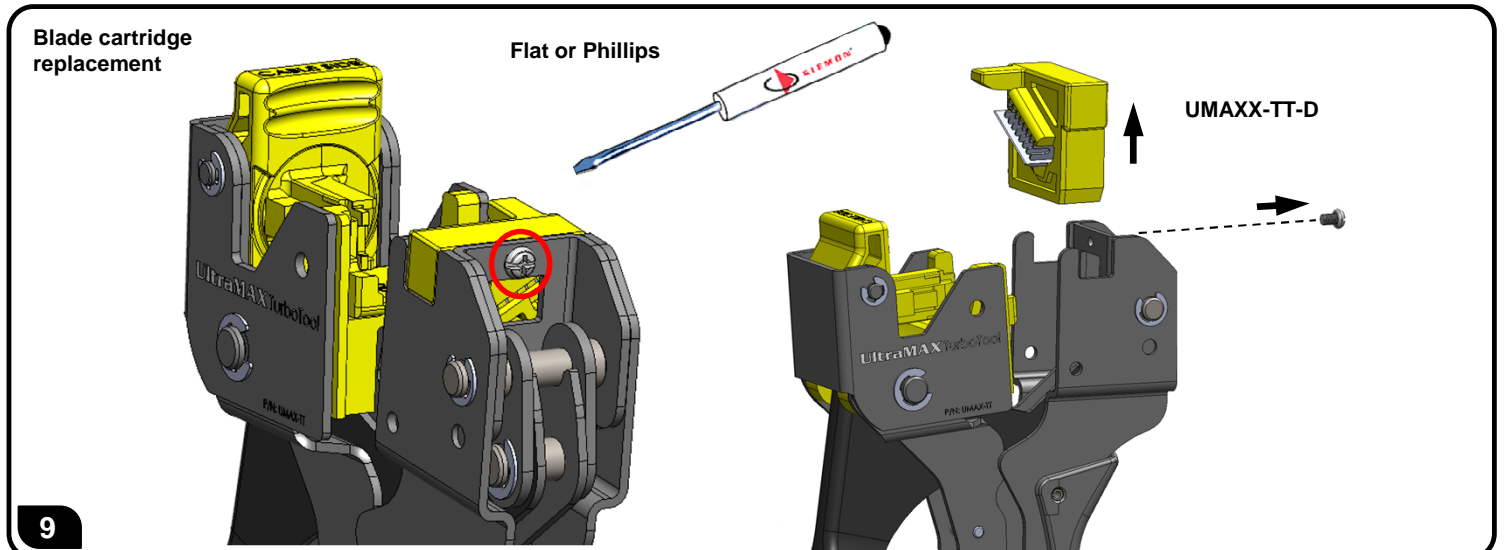
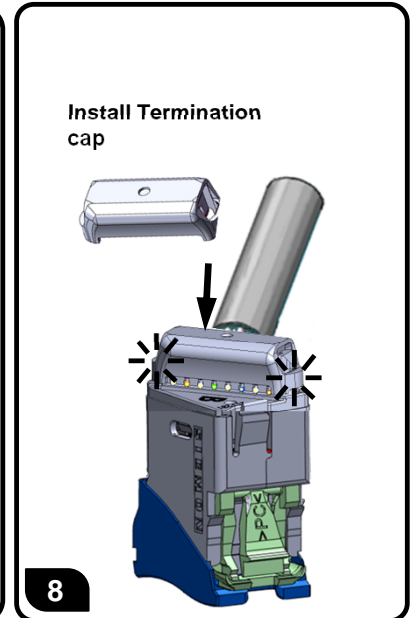
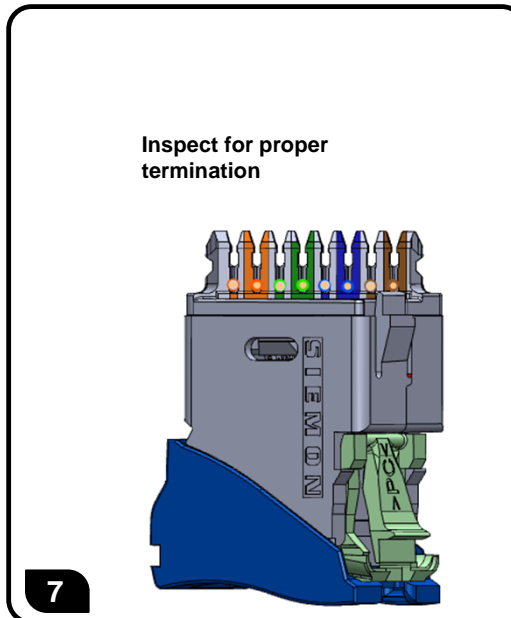
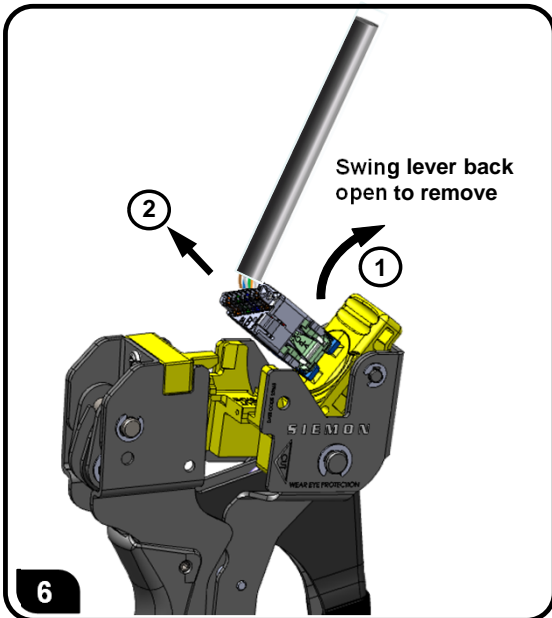
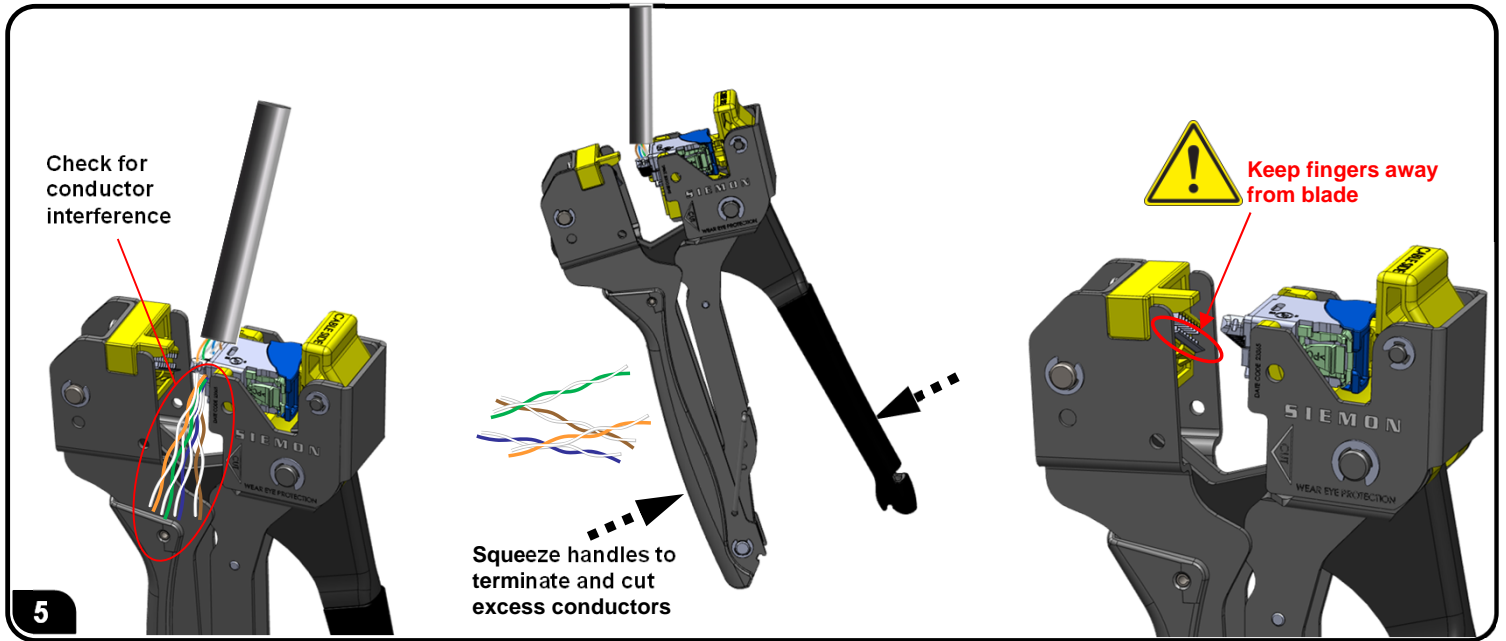

# UltraMAX TURBO TOOL Instructions

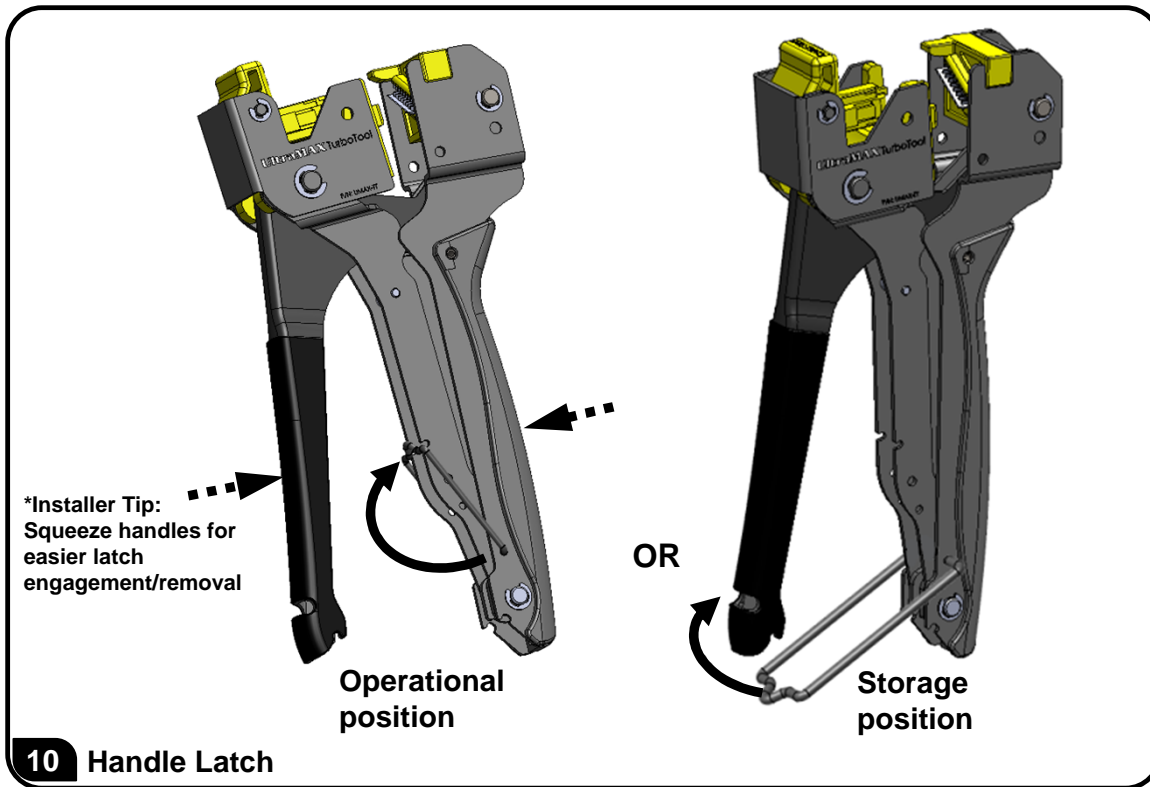

For related termination videos  
and termination instructions  
with UltraMAX products go to:



<https://www.siemon.com>

**To assist safe installations, comply with the following:**

- A. Use caution when installing or modifying telecommunications circuits.
- B. Never touch uninsulated wire terminals unless the circuit has been disconnected.
- C. Never install this device in a wet location.
- D. Never install wiring during a lightning storm.

**Lors de l'installation, respectez les consignes de sécurité suivantes:**

- A. Utiliser avec prudence lors de l'installation ou de la modification circuits de télécommunications.
- B. Ne jamais toucher les bornes de fil métallique non isolés sauf si le circuit a été débranché.
- C. Ne jamais installer cet appareil dans un endroit humide.
- D. Ne jamais installer pendant un orage.

To ensure you have the latest  
revision to this document, please visit: [www.siemon.com](http://www.siemon.com)



Global Headquarters  
Watertown, Connecticut USA  
Tel: (1) 866-548-5814

For a complete listing of our global offices visit our web site