



EN ENGLISH



# CENTAUR

**Integrated Access Control Version V8.0  
Reference Manual**

*The installer's choice*  
**cdvi.com**

# CENTAUR

## Integrated Access Control V8.0

Copyright (C) 2006-2014 CDVI. All rights reserved. Centaur integrated access control system software is protected by copyright law and international treaties. Unauthorized reproduction or distribution of this program, or any portion of it, may result in severe civil and criminal penalties, and will be prosecuted to the maximum extent possible under law.

All other brand and product names are trademarks or registered trademarks of their respective companies.

The information contained in this publication is subject to change without notice.

# Table of Contents

**INSTALLING AND USING CENTAUR** **8**

---

- Centaur Editions ..... 9
- Installation Overview ..... 10
- Centaur Server ..... 10
- Centaur Administration Console (Workstation) ..... 14
- Setting Centaur as a Service Under Windows ..... 16
- Plugging the Hardlock Key..... 17
- Starting the Centaur Server and Software ..... 18
- Software Modules ..... 20

**UNDERSTANDING THE CENTAUR USER INTERFACE** **22**

---

- User Interface Overview ..... 23
- Typing Names and Notes..... 30

**SITES** **32**

---

- Adding a Site ..... 33
- Modifying a Site ..... 36
- Deleting a Site ..... 49
- Communicating with a Site ..... 49

**SMTP** **52**

---

- smtp Configuration ..... 53
- Using a Gmail account to send an email ..... 54
- Using a Yahoo account to send an email..... 55
- Using a Hotmail/Windows Live account to send an email ..... 56
- Email Notification Configuration..... 57
- Event Properties ..... 57

**USERS AND USER GROUPS** **58**

---

- Adding Users ..... 59
- Modifying a User..... 60
- Deleting a User ..... 72
- Adding a User Group ..... 72
- Modifying a User Group ..... 72
- Deleting a User Group ..... 74
- FrontDesk..... 75

**CENTAUR**  
Integrated Access Control V8.0

<b>VISITORS AND VISITOR GROUPS</b>	<b>78</b>
Adding Visitors .....	79
Modifying a Visitor .....	80
Deleting a Visitor .....	85
Adding a Visitor Group .....	85
Modifying a Visitor Group .....	85
Deleting a Visitor Group .....	87
<b>HOLIDAYS</b>	<b>88</b>
Adding a Holiday .....	89
Modifying a Holiday .....	89
Deleting a Holiday .....	90
<b>SCHEDULES</b>	<b>92</b>
Adding a Schedule .....	93
Modifying a Schedule .....	94
Deleting a Schedule .....	96
<b>CONTROLLERS</b>	<b>98</b>
Adding Controllers .....	99
Modifying a Controller .....	101
Deleting a Controller .....	111
Online Controller Firmware Upgrades .....	112
Download .....	113
Other Controller Management Options .....	114
<b>DOORS</b>	<b>116</b>
Adding Doors .....	117
Modifying a Door .....	118
Deleting a Door .....	131
Display Door Status .....	132
<b>ACCESS LEVELS</b>	<b>134</b>
Adding an Access Level .....	135
Modifying an Access Level .....	135
Deleting an Access Level .....	137

# CENTAUR

## Integrated Access Control V8.0

### **CARDS** **138**

Adding Cards .....	140
Modifying a Card .....	141
Deleting a Card .....	144

### **ELEVATOR CONTROL** **146**

Overview of Elevator Control .....	147
------------------------------------	-----

### **RELAYS** **150**

Adding Relays .....	151
Modifying a Relay .....	151
Deleting a Relay .....	154
Display Relay Status and Manual Controls .....	154

### **INPUTS** **156**

Connecting Inputs .....	157
Adding Inputs .....	160
Modifying an Input .....	160
Deleting an Input .....	165
Display Input Status and Manual Controls .....	165

### **OUTPUTS** **166**

Overview of Output Programming .....	167
Adding Outputs .....	168
Modifying an Output .....	168
Deleting an Output .....	172
Display Output Status and Manual Controls .....	172

### **EVENTS** **174**

Event Definition Overview .....	175
Event Schedules and Device Activation .....	177
Alarm Acknowledgement .....	179
Event-Activated Video Control .....	182
Macro & Headcount .....	183

**CENTAUR**  
Integrated Access Control V8.0

**GROUPS 184**

What Are Groups? ..... 185

Adding a Group..... 185

Modifying a Group ..... 186

Adding Details and Assigning Users to Company and Department Group ..... 188

Deleting a Group..... 188

Manual Control of Door and Relay Groups ..... 189

**Guard Tour 190**

Adding Data Collectors ..... 191

Modifying a Data Collector..... 191

Adding Check Points ..... 192

Modifying a Check Point ..... 192

Adding a Round..... 194

Modifying a Round..... 194

**OPERATORS 196**

Overview of Operators ..... 197

Adding a Security Level, Permission, or Operator..... 197

Modifying a Security Level, Permission, or Operator ..... 198

Deleting a Security Level, Permission, or Operator..... 203

**CCTV COMMANDS 204**

Adding a CCTV Command ..... 205

Modifying a CCTV Command ..... 205

Deleting a CCTV Command ..... 206

**Assets 208**

Adding an Asset..... 209

Modifying an Asset..... 209

Deleting an Asset..... 210

**DVR 212**

Accessing the Available DVRs ..... 213

Viewing Archived or Live Video ..... 215

Show Archived Video ..... 216

Display Live Video ..... 217

# CENTAUR

## Integrated Access Control V8.0

<b>MACRO</b>	<b>218</b>
Adding a Macro.....	219
Modifying Macro Settings .....	219
Deleting a Macro.....	220
<b>OPTIONS</b>	<b>222</b>
General Centaur Options.....	223
Event Colour Definitions .....	225
Operator Timeout.....	226
Log File.....	226
<b>PARKING</b>	<b>228</b>
Overview of Parking Management.....	229
<b>PARCEL PICK UP GUIDE</b>	<b>230</b>
Pre-requisites .....	231
Configuration .....	232
<b>MANUAL CONTROLS</b>	<b>246</b>
Event Display.....	247
Manual Controls .....	248
<b>DATABASE MANAGEMENT</b>	<b>258</b>
What are the Centaur Databases?.....	259
Database Management Module.....	260
Database Backup Scheduler .....	267
<b>CENTAUR WAVE PLAYER</b>	<b>270</b>
Centaur Wave Player.....	271
<b>DCOM CONFIGURATION</b>	<b>272</b>
DCOM Configuration for Windows Vista .....	273
DCOM Configuration for Windows XP .....	293
DCOM Configuration for Windows 2003 Server.....	311
DCOM Configuration for Windows 2000 Pro and Server .....	336
<b>WARRANTY</b>	<b>342</b>

# CENTAUR

## Integrated Access Control V8.0



## Installing and Using CENTAUR Software

### What Will I Find?

---

CENTAUR Software is an advanced and powerful CENTAUR Software management software. The following chapter contains important information concerning the installation and use of this software.

# CENTAUR

## Integrated Access Control V8.0

### CENTAUR SOFTWARE EDITIONS

	LITE (FREE EDITION)	STANDARD	PROFESSIONAL*	ENTERPRISE*	GLOBAL*
Sites	1	64	64	64	64
Serial Ports	1	1	1	4	4
Dial Up connection	✓	✓	✓	✓	✓
TCP/IP connection	✓	✓	✓	✓	✓
Cards (per site)	512	2,048	8,196	16,384	16,384
Controllers (per site)	16	32	64	256	256
Doors (per site)	16	128	512	2048	2048
Elevator Control	✓	✓	✓	✓	✓
Elevator Cabs (per site)	2	64	128	512	512
Floors per cab	64	64	64	64	64
Floor groups (per site)	128	128	128	128	128
Include built-in Integration	✓	✓	✓	✓	✓
Global Communication	-	-	-	-	✓
Global User Groups	-	-	-	-	2048
Global Access Levels	-	-	-	-	256
Global Schedules	-	-	-	-	256
Additional Workstation License	-	-	1	1	1

\* FREE from our web site, [www.cdvi.ca](http://www.cdvi.ca) (Security dongle NOT required)

\* Comes with one workstation license.

CENTAUR will run like the Starter Pack when no hardlock key is detected.

### CENTAUR GLOBAL Multi-Site Management Software

CENTAUR GLOBAL edition software is for customers having to manage multiple sites at the same time. Now, it is possible to have a centralized server that communicates simultaneously between sites to achieve globally your usual tasks. You can view events/alarms/door status, lock/unlock doors, add/delete/edit users and cards in real time on several sites at once. GLOBAL edition includes all doors, cards and users of each site on the same server. Through global access levels and schedules, you save time when you add a user by configuring it once.

# CENTAUR

## Integrated Access Control V8.0

## INSTALLATION OVERVIEW

---

This section details how to install the CENTAUR software including the **CENTAUR Software Server** and **Administration Console** (Workstation) available on the CENTAUR USB Key

Each edition of the CENTAUR software has two different applications - the Server and the Administration Console (Workstation). Please note that the terms **Administration Console** and **Workstation** both refer to the same software User Interface, and are used interchangeably.

## CENTAUR SOFTWARE SERVER

---

The CENTAUR Software Server manages the controllers and maintains the CENTAUR Software system's databases. The CENTAUR USB Key includes the CENTAUR Software Server, the Administration Console, several software features, and the reference manuals for these software features, which are all automatically installed together. The reference manuals for CENTAUR Software hardware components are also available on the CENTAUR USB Key

### Computer Requirements (CENTAUR Software Server)

The CENTAUR software is designed to operate with IBM or IBM compatible computers running a suitable Windows operating system as detailed in the "Operating System Requirements (Centaur Server)".

#### **Processor Type:**

- *x64 Processor: AMD Opteron, AMD Athlon 64, Intel Xeon with Intel EM64T support, Intel Pentium IV with EM64T support*
- *x86 Processor: Pentium III-compatible processor or faster*

#### **Processor Speed:**

- *Minimum: x86 Processor: 1.0 GHz, x64 Processor: 1.4 GHz*
- *Recommended: 2.0 GHz or faster*
- *1GB RAM (2GB recommended for superior performance)*
- *6GB of hard disk is recommended; more for larger installations*
- *Ethernet access either through physical 10/100 Mbps Ethernet port or WiFi*

### Operating System Requirements (CENTAUR Software Server)

The CENTAUR Software Server has been tested on the following operating systems:

- *Windows 10 (CENTAUR software version 7.0 and up)*
- *Windows 8, Windows 8.1,*
- *Windows 7 Service Pack 1,*
- *Windows Server 2008 R2 SP1, Service Pack 2,*
- *Windows Server 2012 R2*

### Other software requirements (available on the USB key):

- *.NET Framework 4.5.2*
- *MS SQL Server Express 2016 (x64 & x86)*
- *Microsoft Access Database Engine 2010*
- *VC++ 2015 Redistributable*
- *VC++ 2017 Redistributable*
- *Windows Installer 4.5*
- *Dot NET 4.6.1*

# CENTAUR

## Integrated Access Control V8.0

### Controller Requirements

- *CT-V900-A Rev. 200/210/220/230/260 require firmware R2-C3-70 or higher.*
- *CT-V900-A Rev. 100/110 require firmware R1-01-79 or higher.*

For more information on how to update the controllers, refer to “Online Controller Firmware Upgrades” on page CENTAUR Software.

### Free Technical Support

For technical support in Canada or the U.S., call 1-866-610-0102, Monday to Friday from 8:00 a.m. to 8:00 p.m. EST. For technical support outside Canada and the U.S., call 00-1-450-682-7945, Monday to Friday from 8:00 a.m. to 8:00 p.m. EST. Please feel free to visit our website at [www.cdvi.ca](http://www.cdvi.ca).

# CENTAUR

## Integrated Access Control V8.0

### Installing/Updating the CENTAUR Software Server

This section describes how to install or update the CENTAUR Software Server.

The CENTAUR Software Server software must be installed on the computer where all controllers are or will be connected.



---

*For new installations of the CENTAUR software or when upgrading to the CENTAUR software from a previous version, you need to upgrade the controller firmware version to R2-C3-70 or higher and use a new hardlock key.*

---



---

*To install the CENTAUR software on Windows 2000/2003/XP/Vista operating systems, you must be logged on as Administrator.*

---

1. Insert the CENTAUR USB Key Key into the computer's USB port.
2. If the auto run feature is enabled, go to the step 3. Otherwise, click **Run** from the **Start** menu, type the appropriate drive indicator (x:\) followed by **setup.exe** or click **Browse** to search for the **setup.exe** file. Click **OK**.
3. The **CENTAUR Software Setup** window will appear. If this is a new installation of the CENTAUR software, click **Next** and go to the next step. To update previously installed CENTAUR software, select **Update**, click **Next**, follow the on-screen instructions, and click **Finish**.
4. The **License Agreement** window will appear. To install the CENTAUR software, select **I accept the terms of the license agreement**, and click **Next**.
5. The **Type of installation** window will appear. To install the CENTAUR Software Server, select **System management and communication with control panels (Server and Workstation)**. If you wish to select a different folder destination for the CENTAUR Software or MSDE software, click the appropriate **Browse** button, choose the folder destination, and click **OK**. Click **Next**.



---

The Administration Console is installed with the CENTAUR Software Server by default. The CENTAUR software is installed by default to C:\Program Files\CDV Americas\CENTAUR Software. The MSDE software is installed by default to C:\Program Files\Microsoft SQL Server.

---

6. The **Selecting Languages** window will appear. The CENTAUR Software Server supports three languages. **English** is automatically supported by default. Select two other languages and click **Next**.
7. The **CENTAUR Software Pre-Requisites** window will appear. Setup automatically detects and lists which prerequisites have and have not been installed on your computer. To install the required software components, click **Next** and follow the on-screen instructions. If all prerequisites are already installed, the setup will skip this step (go to the next step).
8. When Setup has completed the installation of the CENTAUR software, the **InstallShield Wizard Complete** window will appear. Select if you wish to restart your computer now or later. Click **Finish**.

# CENTAUR

## Integrated Access Control V8.0



---

***Before you can use the CENTAUR software, you must restart your computer.***

---



---

An icon for the Administration Console is automatically added to your computer desktop.

---



---

The Centaur software manuals are automatically installed on your computer. To locate a software manual, click Start > Programs > CDVI Americas > Centaur > Administration Console > Manuals.

---



---

The Centaur hardware manuals must be manually installed on your computer. To locate the hardware manuals on the CD, open Windows Explorer. Click on the appropriate drive indicator (x:\) from which the Centaur CD is inserted. Double-click the Manuals folder. Double-click the Hardware Manuals folder. Copy and paste the manual(s) to the computer drive and folder of your choice.

---

In situations where remote workstations will access the Server through a network, DCOM must be configured on the CENTAUR Software Server computer (refer to “DCOM Configuration” on page CENTAUR Software).

# CENTAUR

## Integrated Access Control V8.0

## CENTAUR SOFTWARE ADMINISTRATION CONSOLE (WORKSTATION)

---

This section describes how to install a CENTAUR Software Administration Console on a networked workstation.

The CENTAUR Software Administration Console is installed on a networked workstation computer using the CENTAUR USB Key. The CENTAUR Software Administration Console allows operators to monitor and manage the CENTAUR Software system remotely by accessing the CENTAUR Software Server's databases and its controllers through a network.



---

***In order for a remote workstation to access the Server, DCOM must be configured on the Centaur Server computer (refer to "DCOM Configuration" on page CENTAUR Software).***

---

### Computer Requirements (Workstation)

The CENTAUR software is designed to operate with IBM or IBM compatible computers running a suitable Microsoft Windows operating system as detailed in the Operating System Requirements below.

#### **Processor Type:**

- *x64 Processor: AMD Opteron, AMD Athlon 64, Intel Xeon with Intel EM64T support, Intel Pentium IV with EM64T support*
- *x86 Processor: Pentium III-compatible processor or faster*

#### **Processor Speed:**

- *Minimum: x86 Processor: 1.0 GHz, x64 Processor: 1.4 GHz*
- *Recommended: 2.0 GHz or faster*
- *1GB RAM (2GB recommended for superior performance)*
- *6GB of hard disk is recommended; more for larger installations*
- *Ethernet access either through physical 10/100 Mbps Ethernet port or WiFi*

### Operating System Requirements (Workstation)

The CENTAUR Software Administration Console has been tested on the following operating systems:

- *Windows 11 (CENTAUR software version 8.0 and up)*
- *Windows 10 (CENTAUR software version 7.0 and up)*
- *Windows 8, Windows 8.1,*
- *Windows 7 Service Pack 1,*
- *Windows Server 2008 R2 SP1, Service Pack 2,*
- *Windows Server 2012 R2*

### Other software requirements (available on the USB key):

- *.NET Framework 4.5.2*
- *MS SQL Server Express 2016 (x64 & x86)*
- *Microsoft Access Database Engine 2010*
- *VC++ 2015 Redistributable*
- *VC++ 2017 Redistributable*
- *Windows Installer 4.5*
- *Dot NET 4.6.1*

# CENTAUR

## Integrated Access Control V8.0

### Installing/Updating the Administration Console (Workstation)

This section describes how to install or update the CENTAUR Software Administration Console (Workstation).

1. Insert the CENTAUR USB Key into the computer's USB port.
2. If the auto run feature is enabled, go to the next step. Otherwise, click **Run** from the **Start** menu, type the appropriate drive indicator (x:\) followed by **setup.exe** or click **Browse** to search for the setup.exe file. Click **OK**.
3. The CENTAUR Software Setup window will appear. If this is a new installation of the CENTAUR software, click **Next** and go to the step 4. To update previously installed CENTAUR software, select **Update**, click **Next**, follow the on-screen instructions, and click **Finish**.
4. The License Agreement window will appear. To install the CENTAUR software, select **I accept the terms of the license agreement** and click **Next**.
5. The **Type of installation** window will appear. To install the Administration Console (Workstation), select **System management only, will not communicate with control panels (Workstation only)**. If you wish to select a different folder destination for the CENTAUR software, click the appropriate **Browse** button, choose the folder destination, and click **OK**. Click **Next**.



---

*The CENTAUR software is installed by default to C:\Program Files\CDVI Americas\CENTAUR Software.*

---

6. The CENTAUR Software Pre-Requisites window will appear. Setup automatically detects and lists which prerequisites have and have not been installed on your computer. To install the required software components, click **Next** and follow the on-screen instructions. If you already have all prerequisites, Setup will skip this step (continue with next step).
7. When Setup has completed the installation of the CENTAUR software, the InstallShield Wizard Complete window will appear. Select if you wish to restart your computer now or later. Click **Finish**.



---

***Before you can use the Centaur software, you must restart your computer.***

---



---

An icon for the Administration Console (Workstation) is automatically added to your computer desktop.

---



---

*The CENTAUR software manuals are automatically installed on your computer. To locate a software manual, click **Start**,*

---



---

*The CENTAUR Software hardware manuals must be manually installed on your computer. To locate the hardware manuals on the CD, open Windows Explorer. Click on the appropriate drive indicator (x:\) from which the CENTAUR USB Key is running. Double-click the **Manuals** folder. Double-click the **Hardware Manuals** folder. Copy and paste the manual(s) to the computer drive and folder of your choice.*

---

# CENTAUR

## Integrated Access Control V8.0

### SETTING CENTAUR SOFTWARE AS A SERVICE UNDER WINDOWS

These instructions pertain to Windows 2000/2003/XP/Vista operating systems, and will enable the **Auto-start service when OS starts** feature in the CENTAUR Software Service Manager. This feature will automatically start the CENTAUR Software Server when you start the computer. You will only need to start the CENTAUR Software Administration Console.

1. If the CENTAUR Software Service Manager is already stopped and has been exited, proceed to step 5. Otherwise, click Start gPrograms gCDVI Americas gCENTAUR Software CENTAUR Software Service Manager. The CENTAUR Software Service Manager window will appear.
2. Click Stop. The Operator Logon window will appear.



---

*The **Operator Rights Validation** window will not appear if CENTAUR Software is set as a service under Windows.*

---

3. Enter your CENTAUR Software Logon ID and Password and click OK. The default Logon ID is Admin and the default Password is Admin.
4. From the icon tray, right-click the CENTAUR Software Service Manager icon and click Exit.



CENTAUR Software Service Manager icon

5. To manually set CENTAUR Software as a service under Command Prompt, go directly to step 6. Otherwise, open Windows Explorer and locate drive (C:). Double-click Program Files, double-click CDVI Americas, double-click CENTAUR Software, double-click CENTAUR Software Server, and double-click Service.bat. Proceed to step 7.
6. To manually set CENTAUR Software as a service under Command Prompt, click Start gPrograms gAccessories gCommand Prompt.
  - a) The **Command Prompt** window will appear. Type `cd\program files\CDVI Americas\centaur\centaur server` and press **Enter**.
  - b) Type `spxsvr.exe /service` and press **Enter**. Close the **Command Prompt** window.



---

*Ensure that there is a space between `spxsvr.exe` and the front slash (/).*

---

```

c:\ Command Prompt
Microsoft Windows XP [Version 5.1.2600]
(C) Copyright 1985-2001 Microsoft Corp.

C:\Documents and Settings\fdugre>cd\program files\cdv americas\centaur\centaur server
C:\Program Files\CDU Americas\Centaur\Centaur Server>spxsvr.exe /service
C:\Program Files\CDU Americas\Centaur\Centaur Server>_
  
```

# CENTAUR

## Integrated Access Control V8.0

7. Click Start >Programs >CDVI Americas >CENTAUR Software >CENTAUR Software Service Manager.
8. The CENTAUR Software Service Manager window will appear. Select the Auto-start service when OS starts check box.
9. If you want the Service Manager to verify every 5 minutes if the service is running or not, and then start it if it is not running, select the Auto-restart service when stopped check box. Close the window.
10. Restart your computer. The CENTAUR Software Service Manager will now start automatically. To run CENTAUR Software you will only need to click Start >Programs >CDVI Americas >CENTAUR Software >Administration Console >Administration Console.



## PLUGGING THE HARDLOCK KEY

A hardlock key is required to enable communication with CENTAUR Software's controller. CENTAUR Software's software will run in Starter Pack version when no hardlock key is detected. The hardlock key is available in two different configurations, one for parallel port and one for USB port.

- The blue hardlock key is designed to be plugged into your computer USB port.
- The black hardlock key is designed to be plugged into your computer parallel port.

Plug the parallel or USB hardlock key identified as Server to the port of the computer used as the CENTAUR Software Server (CENTAUR Software Service Manager).

Plug the parallel or USB hardlock key identified as Workstation to the port of the computer used as a workstation.



The hardlock key is required on the computer used as the CENTAUR Software Server as well as on each workstation. You must have the hardlock key plugged in the CENTAUR Software server/workstation port before starting the CENTAUR Software Service Manager otherwise the software will run in Starter Pack version.



*The hardlock key version 5.2 will not work with the CENTAUR Software version 6.0 or 7.0.*

# CENTAUR

## Integrated Access Control V8.0

### STARTING THE CENTAUR SOFTWARE SERVER AND SOFTWARE

This section describes how to start the CENTAUR software from the CENTAUR Software Server computer or a networked workstation. Note that before starting the CENTAUR software from a networked workstation, the CENTAUR Software Service Manager must be started.

#### Starting the CENTAUR Software Server



You must have the hardlock key plugged in the CENTAUR Software server port before starting the CENTAUR Software Service Manager otherwise

1. From the CENTAUR Software server computer, click **Start** → **Programs** → **CDVI Americas** → **CENTAUR Software** → **CENTAUR Software Service Manager**. The CENTAUR Software Service Manager window will appear.
2. From the CENTAUR Software Service Manager window, click the **Start/Continue** button. Once the CENTAUR Software Service Manager is running, you can close the CENTAUR Software Service Manager window.



*The **Auto-start service when OS starts** and **Auto-restart service when stopped** check boxes in the CENTAUR Software Service Manager window are only available when CENTAUR Software is set as a service under Windows, refer “Setting Centaur as a Service Under Windows” on page CENTAUR Software*



*To stop the CENTAUR Software Service Manager, click **Stop**. If the Operator Rights Validation window appears, enter your CENTAUR Software Logon ID and Password, and click **OK**. The Operator Rights Validation window will not appear if CENTAUR Software is a service under Windows (refer to “Setting Centaur as a Service Under Windows” on page CENTAUR Software).*

# CENTAUR

## Integrated Access Control V8.0

### Starting the CENTAUR Software Administration Console (Workstation) Software

1. From the CENTAUR Software server computer or from a networked workstation, click **Start** → **Programs** → **CDVI Americas** → **CENTAUR Software** → **Administration Console** → **Administration Console**. The **CENTAUR Software Logon** window will appear.



---

*If you are starting a software module, click **Start** → **Programs** → **CDVI Americas** → **CENTAUR Software** → **Administration Console** → the appropriate software.*

---

2. From the CENTAUR Software Logon window, type the appropriate **Logon ID** and **Password**. The default Logon ID is **Admin** and the default Password is **Admin**. If you are trying to log on to a CENTAUR Software Server that is on a network, type the Server computer's network name or IP address in the **Computer** text box. From the **Language** drop-down list, select the desired language. Click **OK**.



---

*To allow access from remote workstations, **DCOM** must be configured on the **CENTAUR Software Server** computer (refer to “**DCOM Configuration**” on page **CENTAUR Software**).*

---



---

*When starting **CENTAUR Software** for the first time, a dialogue box appears asking if you would like to use the site configuration wizard. Refer “**Adding a Site**” on page **CENTAUR Software** for more information.*

---

## SOFTWARE MODULES

---

All software modules listed below unless, are automatically installed with the CENTAUR Software Server or Workstation software.

- **FrontDesk:** This module provides an easy to use interface to program user properties and includes an advanced search engine. For more information, refer to “FrontDesk” on page CENTAUR Software.
- **Import/Export Application:** *This module imports or exports user information into/from Centaur. Supported file formats are XML and CSV for the import, and XML for the export. The access level are not exported nor imported. See the **CSVReadme.txt** file for more information on the CSV fields for the import. The **CSVReadme.txt** file is located in the **C:\Program Files (x86)\CDVI Group\Centaur\Administration Console** folder.*
- **Database Management (Server only):** This feature allows you to control and manage the large and complex database files of the CENTAUR software. You can back up and restore database files, purge events from selected sites during specific periods, limit the size of database files and delete entire database files. For more information, refer to “Database Management” on page CENTAUR Software.
- **Database Backup Scheduler (Server only):** CENTAUR Software’s database backup scheduler enables you to schedule regular backups of the CENTAUR Software databases. You can back up the Main database and the Event database separately, specify the location of the backup files and select how often (daily, weekly, or monthly) the backup will occur. For more information, refer to “Database Backup Scheduler” on page CENTAUR Software.
- **FrontGuard:** This module uses events generated in CENTAUR Software to retrieve a picture and/or video feed to help you identify users or to view the location where an event has occurred. For more information, refer to “CENTAUR Software’s FrontGuard” manual.
- **Locator:** Designed to function with the Global Anti-Passback, this allows you to monitor when users enter and exit designated doors in real-time, retrieve user information and print customizable user access reports.
- **WavePlayer:** This CENTAUR Software feature is designed to enable a .wav file to be played on the computer when an event that requires acknowledgement occurs. The sound can replay at programmed intervals until the alarm is acknowledged. For more information, refer to “Centaur Wave Player” on page CENTAUR Software.
- **Pro-Report:** This module features a user-friendly wizard for generating system reports. Generate quick (one-time), pre-defined and scheduled reports for up to 14 different report types. You can also search, group and sort your reports.
- **FrontView:** The real-time graphic interface gives you point-and-click control over doors, relays, inputs, outputs, and controllers through a graphical floor plan. For more information, refer to “CENTAUR Software’s FrontView” manual.
- **Diagnostic Tool:** The Diagnostic Tool allows you to view your system information to ensure all of the components required to run the CENTAUR software have been installed. Within the Diagnostic Tool’s menu, you may save or copy your system information to a specific folder on your computer or send it directly to our technical support team in the event that you require assistance. This tool is also helpful in assessing which prerequisites your computer may require when upgrading to the latest version of the CENTAUR software.

# CENTAUR

Integrated Access Control V8.0

# CENTAUR

## Integrated Access Control V8.0



## Understanding the Centaur User Interface

### What Will I Find?

---

The following chapter presents the structure of the Administration Console main window including the different windows, menus, and buttons.

# CENTAUR Integrated Access Control V8.0

## USER INTERFACE OVERVIEW

The following picture demonstrates the Centaur User Interface structure.

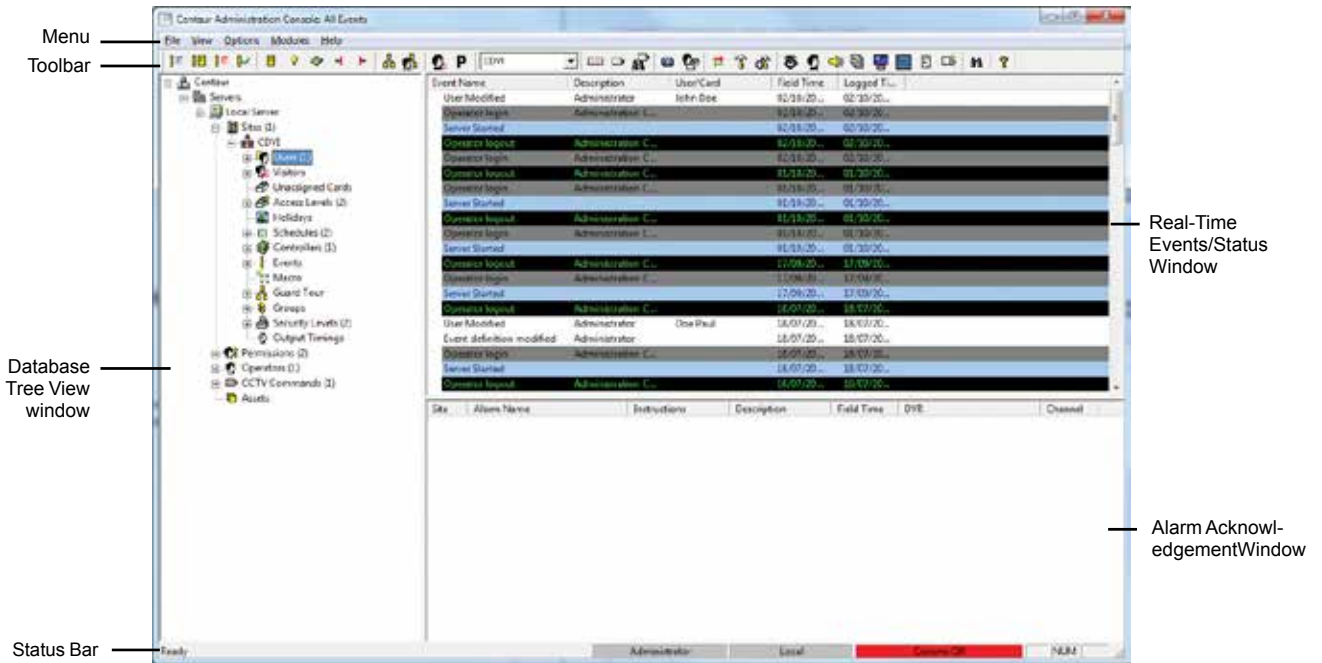

# CENTAUR

## Integrated Access Control V8.0

### Menu Bar

The menu bar gives access to the **File**, **View**, **Options**, **Modules**, and **Help** menus.

- The **File** menu gives access to the **Exit** sub-menu allowing to close the Centaur Administration Console application.
- The **View** menu gives access to the following:
  - **Toolbar**: Allows to show or hide the Toolbar.
  - **Status Bar**: Allows to show or hide the Status Bar.
  - **Refresh**: Allows to refresh the Tree View and the Status windows.

The following sub-menus allow to select what events will be displayed in the Events/Status window. The following selections are also available from the Toolbar.

- **All events**: Refer to “Display All Events” for more information.
- **Access events**: Refer to “Display Access Events” for more information.
- **Abnormal events**: Refer to “Display Abnormal Events” for more information.
- **Acknowledged events**: Refer to “Display Acknowledged Events” for more information.

The following sub-menus allow to select what devices will be displayed in the Events/Status window. The following selections are also available from the Toolbar.

- **Door status**: Refer to “Displaying and Controlling the Status of a Door” for more information.
  - **Relay status**: Refer to “Displaying and Controlling the Status of a Relay” for more information.
  - **Controller status**: Refer to “Displaying Controller Status” for more information.
  - **Input status**: Refer to “Displaying and Controlling the Status of an Input” for more information.
  - **Output status**: Refer to “Displaying and Controlling the Status of an Output” for more information.
- The **Options** menu gives access to the following:
    - **Options**: Refer to “General Centaur Options” for more information.
    - **Events Colours**: Refer to “Event Colour Definitions” for more information.
    - **Operator Timeout**: Refer to “Operator Timeout” for more information.
    - **Log File**: Refer to “Log File” for more information.

# CENTAUR

## Integrated Access Control V8.0

- The **Modules** menu gives access to the following:
  - **FontDesk**: Refer to “FrontDesk” for more information.
  - **Import/Export Application**
  - **Database Management**: Refer to “Database Management Module” for more information.
  - **Database Backup Scheduler**: Refer to “Database Backup Scheduler” for more information.
  - **FrontGuard**
  - **Locator**
  - **WavePlayer**: Refer to “Centaur Wave Player” for more information.
  - **Pro-Report**
  - **FrontView**
  - **Diagnostic Tool**
  - **CMPP card enrollement utility**
- The **Help** menu gives access to either the Centaur help file or the about Centaur page. The help window is always on top of the application.

# CENTAUR

## Integrated Access Control V8.0

### Toolbar

The Toolbar is divided in different categories as described in the following example.

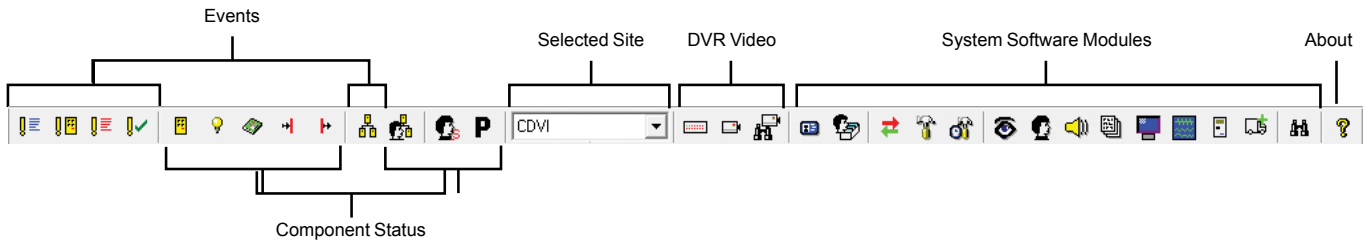

### Selected Site

Select which site to view and/or act upon.



### Toolbar Buttons

The following table describes each Toolbar button.

CATEGORY	BUTTON	DESCRIPTION	KEYBOARD SHORTCUT	MENU
Events		All events Refer to “Display All Events” on page 218 for more information.	1	View -> All
		Access events Refer to “Display Access Events” on page 218 for more information.	2	View -> Access events
		Abnormal events Refer to “Display Abnormal Events” on page 218 for more information.	3	View -> Abnormal events
		Acknowledged events Refer to “Display Acknowledged Events” on page 218 for more information.	4	View - Acknowledged events
		Guard Tour Events Refer to “Display Guard Tour Events” on page 218 for more information.	N/A	N/A

















# CENTAUR

## Integrated Access Control V8.0

CATEGORY	BUTTON	DESCRIPTION	KEYBOARD SHORTCUT	MENU
Status		Door status Refer to “Displaying and Controlling the Status of a Door” on page 219 for more information.	5	View -> Door status
		Relay status Refer to “Displaying and Controlling the Status of a Relay” on page 220 for more information.	6	View -> Relay status
		Controller status Refer to “Displaying Controller Status” on page 221 for more information.	7	View -> Controller status
		Input Status Refer to “Displaying and Controlling the Status of an Input” on page 222 for more information.	8	View -> Input status
		Output Status Refer to “Displaying and Controlling the Status of an Output” on page 223 for more information.	9	View -> Output status
		Guard Tour Live Rounds Refer to “Displaying Guard Tour Live Rounds” on page 224 for more information.	N/A	N/A
		Display Visitor Status Refer to “Displaying Visitor Status” on page 225 for more information.	N/A	N/A
		Display Global Parking Status Refer to “Displaying Global Parking Status” on page 226 for more information.	N/A	N/A
Video		Display DVR Settings Refer to “Modifying DVR Settings” on page 200 for more information.	N/A	N/A
		Display Live Video Refer to “Display Live Video” on page 204 for more information.	N/A	N/A
		Search Video Refer to “Show Archived Video” on page 203 for more information.	N/A	N/A

# CENTAUR

## Integrated Access Control V8.0

CATEGORY	BUTTON	DESCRIPTION	KEYBOARD SHORTCUT	MENU
Modules		Open Badge Editor Refer to “Badge” on page 50 for more information.	N/A	N/A
		Open FrontDesk Refer to “FrontDesk” on page 62 for more information.	Ctrl-F1	Module -> FrontDesk
		Open Import/Export Application	Ctrl-F2	Module -> Import/Export Application
		Open Card Import/Export Refer to “Centaur Card Import/Export Feature” on page 134 for more information.	Ctrl-F2	Module -> Card import/Export
		Open Database Management Module Refer to “Database Management Module” on page 231 for more information.	Ctrl-F3	Module -> Database Management
		Open Database Backup Scheduler Refer to “Database Backup Scheduler” on page 238 for more information.	Ctrl-F4	Module -> Database Backup Scheduler
		Open FrontGuard	Ctrl-F5	Module -> Front Guard
		Open Locator	Ctrl-F6	Module -> Locator
		Open WavePlayer Refer to “Centaur Wave Player” on page 241 for more information.	Ctrl-F7	Module -> WavePlayer
		Open Pro-Report	Ctrl-F8	Module -> Pro-Report
		Open FrontView	Ctrl-F9	Module -> FrontView
		Open Diagnostic Tool	Ctrl-F10	Module -> Diagnostic Tool
		Open Headcount	Ctrl-F11	Module -> Headcount
		Open CMPP Allows loading or adding a card using a CMPP card enrollment station.	Ctrl-F12	Module -> CMPP
		Open Parcel Pick Up Issue a one-time usage PIN code to unlock one storage locker.	N/A	Module -> Pick Up
	Search Allows to perform advanced search. Refer to page 64 for more information.	Ctrl-F	N/A	
About		About Gives information about the Centaur Administration software, and CDVI contact information.	N/A	N/A

# CENTAUR

## Integrated Access Control V8.0

### Database Tree View Window

The Database Tree View window located in the left-hand portion of your screen allows to create and configure a site including all its objects. From the Database Tree View window you can create and/or modify:

- “Sites” on page <OV>
- “Users and User Groups” on page 58
- “Visitors and Visitor Groups” on page 78
- “Holidays” on page 88
- “Schedules” on page 92
- “Controllers” on page 98
- “Doors” on page 116
- “Access Levels” on page 134
- “Cards” on page 138
- “Elevator Control” on page 146
- “Relays” on page 150
- “Inputs” on page 156
- “Outputs” on page 166
- “Events” on page 174
- “Groups” on page 184
- “Security Levels” on page 199
- “Permissions” on page 200
- “Operators” on page 196
- “CCTV Commands” on page 204
- “Macro” on page 218

### Real-Time Events/Status Window

The Real-Time Events/Status window lists all the events or device status for the selected site (see “Selected Site” on page 26). Use the **View** menu (See the **View** menu on page “Menu Bar” on page 24) or the **Toolbar** button (See “Toolbar” on page 26) to select what you want to display in the Real-Time Events/Status window.

When **All events**, **Access events**, **Abnormal events**, or **Acknowledged events** is selected, the Real-Time Events/Status window displays the following: **Event Name**, **Description**, **User/Card**, **Field Time** (date and time), and **Logged Time**.

When **Door/Relay/Input/Output/Visitor/Parking status** is selected, the Real-Time Events/Status window displays the following: **Door/Relay/Input/Output Name**, **Address**, and **Status**.

When **Controller status** is selected, the Real-Time Events/Status window displays the following: **Controller Name**, **Address**, **Status**, **Number of Cards**, and **Number of Errors**.

# CENTAUR

## Integrated Access Control V8.0

### Alarms Window

The Alarms window lists all the alarms related to all sites. The Alarms window displays the following: **Site**, **Alarm Name**, **Instructions**, **Description**, and **Field Time** (date and time).

### Status Bar

The status bar is located at the bottom of your screen displays the following:

- **Status:** Indicates the status of the Administration Console.
- **System Operator:** Displays the current system operator login name.
- **Server name:** Indicates the name of the server.
- **Communication:** Indicates the site communication status. Refer to “Communicating with a Site” on page <OV> for more information.
- **Keyboard:** Indicates the status of your computer keyboard **Caps Lock**, **Num Lock**, and **Scroll Lock** keys.

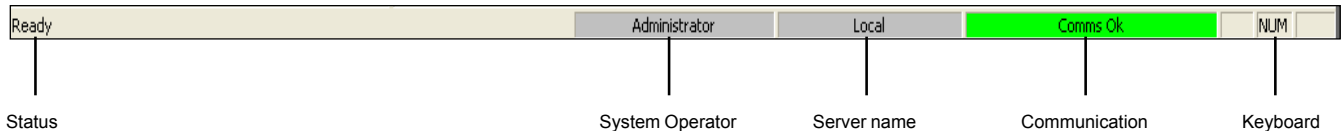

## TYPING NAMES AND NOTES

1. When changing the name of a system component in the Database Tree View window (i.e. controllers, events, doors, etc.), Centaur will immediately refresh the screen. Press F5 to manually refresh the screen.
2. Please note that Centaur does not support more than 50 characters for **Name** fields and 255 characters for **Notes** fields.
3. Use the drop-down list on the right of certain text fields to type the text in more than one language (see **Languages** below for more information).

### Languages

The Centaur software is a trilingual software. Many of the text fields in the property windows (when programming sites, doors, etc.) will have a drop-down list available. Use these drop-down lists on the right of certain text fields to enter item names and notes in more than one language. When a Centaur Administration Console is installed on a workstation computer, you will be asked to select one language. The Administrator Console will display the item names and notes in the language selected from the Administrator Console's login window.

# CENTAUR

Integrated Access Control V8.0

# CENTAUR

## Integrated Access Control V8.0



## Sites

### What Will I Find?

---

Each site can monitor and operate a specific number of cards, controllers, inputs, relays, and multi-function outputs, depending on the Centaur software edition being used.

The first step in setting up your system is creating and defining your sites. Once your sites have been defined you can begin programming the remaining items such as controllers, users, visitors, schedules, and doors. In the **Sites** branch, local sites will be represented by a traffic light icon, remote (dial-up) sites will be represented by a telephone icon, and TCP/IP sites will be represented by a network icon depicting five computers.

# CENTAUR

## Integrated Access Control V8.0

### ADDING A SITE

Perform the following to add a site:

1. From the **Database Tree View window** (left-hand portion of your screen), right-click the **Sites** branch and click **Add Site**. You can also click the **Sites** branch and press the keyboard **Insert** key.
2. A dialogue box appears requesting if you would like to use the site configuration wizard. The site configuration wizard guides you through the minimum required settings to get the site communicating with its controllers. If you want to use the site configuration wizard, click **Yes** and follow the steps detailed in “Using the Site Configuration Wizard (Recommended)”. If you do not want to use the site configuration wizard, click **No** and go to step 3. If you do not want to add a site, click **Cancel**.
3. In the **New Site** window, type the desired site name. We recommend using a name that is representative of the site such as “Manufacturing Plant (Montreal)”.
4. Click **OK**.

### Using the Site Configuration Wizard (Recommended)

The site configuration wizard guides you through the minimum required settings to get the site communicating with its controllers. When starting Centaur’s **Administration Console** for the first time or when adding a site, a dialogue box appears asking if you would like to use the site configuration wizard. If you click **Yes**, the **Site & Communication Setup** window appears.

1. In the **Site Name** text field, type the desired site name. We recommend using a name that is representative of the site such as “Manufacturing Plant (Montreal)”.
2. From the **Communication Type** drop-down list, select the desired connection method. For more detailed information on the available types, refer to “Selecting the Site Communication Type” on page 36. The site configuration wizard is dynamic, therefore only options corresponding to the selected communication type will be available. Other options will be unavailable.

# CENTAUR

## Integrated Access Control V8.0

3. Set the remaining available options as required and click **Next**. For more information on these options, which include **Baud Rate, Phone Number, Modem, and Serial Settings** (COM Port Assignment), refer to “Site Communication Settings” on page 36.

4. From the **Number of Controllers** drop-down list, select the number of controllers you would like to add to this site.

5. If you would like to apply the same controller and door settings to all controllers, select **Apply default settings to all controllers** and go to step 6. If you would like to apply different controller and door settings to each controller, select **Individually setup each controller** and go to step 7.
6. If you have selected the **Apply default settings to all controllers** check box:
  - a) Under **Controller Default Settings**, set the available options as required. For more information on these options, which include **IP Address, Port Number, and Input Config**, refer to “Setting the Controller Input Configuration” on page 106 and “Configuring the Controller Communication Settings” on page 106. **Num Doors** allow selecting the number of doors to be created for each controller.
  - b) Under **Door Default Settings**, set the available options as required. For more information on these options, refer to “Unlock Time” on page 123, “Lock Control” on page 123 and “Reader Type” on page 122. Please note that the **Door Type** option is not yet supported and therefore will be set to **Access** by default. Refer to “Door Type” on page 120 for more information.
  - c) Click **Finish**.

# CENTAUR Integrated Access Control V8.0

7. If you have selected the **Individually setup each controller** check box:

a) Click **Next**.

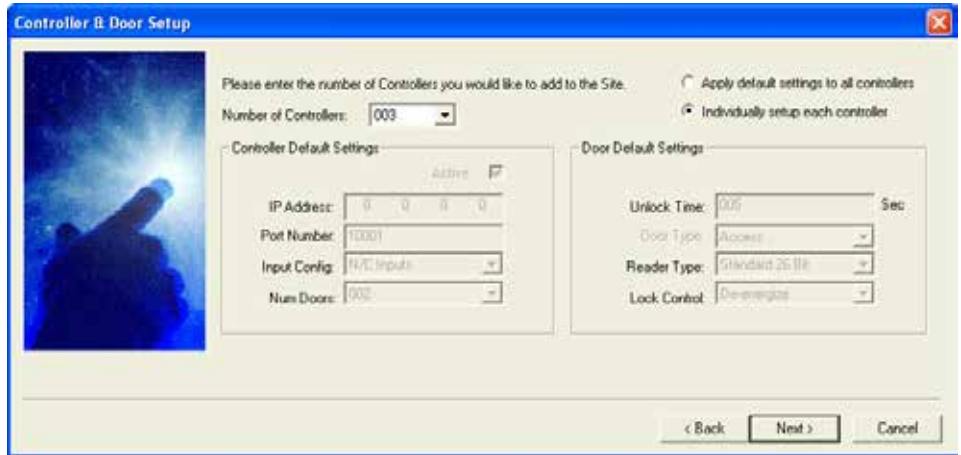

b) Set the available options as required for each controller and click **Next**. For more information on these options, refer to “Controller Configuration” on page 91. To change the name of a controller, double click on the name of the controller that you want to edit and type the new name. **Num Doors** fields allow selecting the number of doors to be created for each controller.

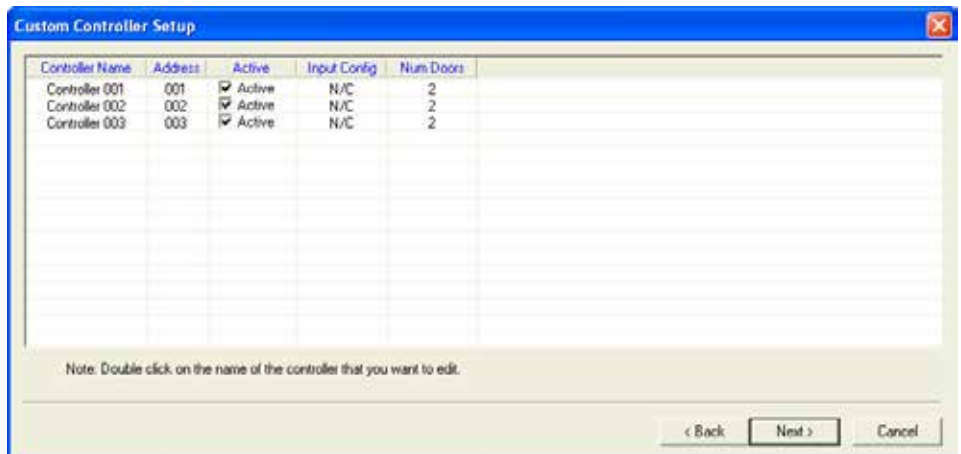

c) Set the available options, which includes **Door name**, **Reader Protocol**, **Lock Ctrl**, and **Unlock Time**, as required for each door. For more information on these options, refer to “Door Settings” on page 107. To change the name of a door, double click on the name of the door that you want to edit and type the new name. To change the **Unlock Time**, double click on the value to be changed, and enter the new value in seconds. To change the **Reader Protocol** and/or the **Lock Ctrl**, click on the desired controller and select the new settings from the drop lists.

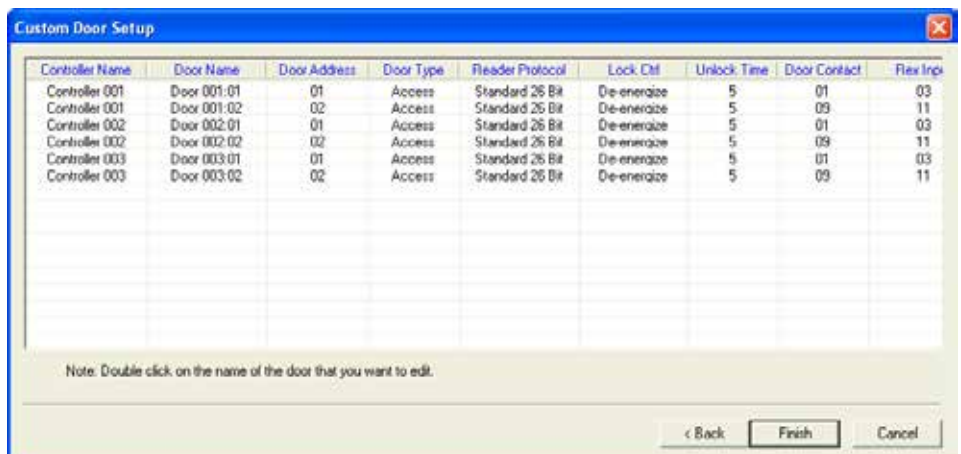

# CENTAUR

## Integrated Access Control V8.0

### MODIFYING A SITE

To modify an existing site, from the Database Tree View window, right-click the desired site from the **Sites** branch and click **Properties**. You can also select the desired site and press the keyboard **Enter** key. The **Site Properties** window will appear, allowing you to configure the site.

#### General Site Properties

Select the **Site** tab from the **Site Properties** window. The **Site** tab will allow you to view the site address as well as record the site name and any additional notes.

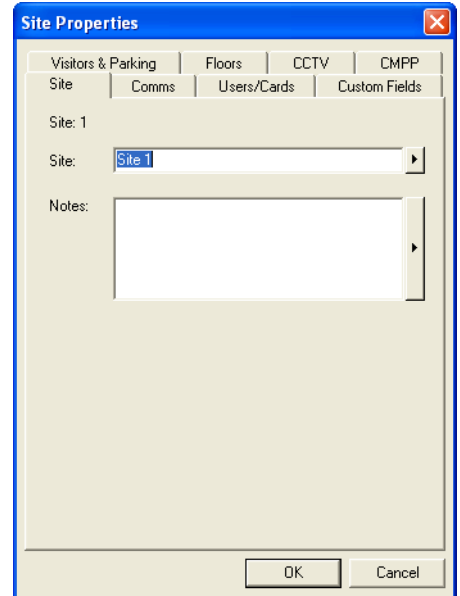

#### Changing the Site Name

Use the **Site** text field to identify the site location. We recommend using a name that is representative of the site such as "Manufacturing Plant (Montreal)". Also, refer to "Typing Names and Notes" on page 30.

#### Typing the Site Notes

Use the **Notes** text field to record any additional notes that may be required. We recommend that you keep a log of what settings were changed and when they were changed. Also, refer to "Typing Names and Notes" on page 30.

### Site Communication Settings

Select the **Comms** (Communications) tab from the **Site Properties** window. Each site can be connected either locally, remotely, or through a TCP/IP connection.

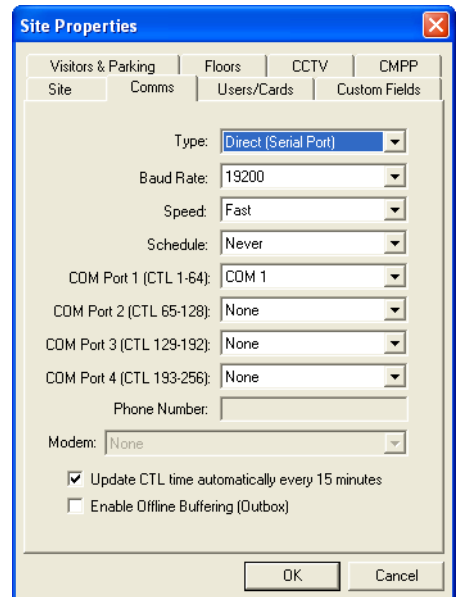

When a site is communicating (online) with the Centaur Server computer, you will not be able to modify the site communication settings. This is to prevent any accidental disconnection from the Centaur Server computer.

#### Selecting the Site Communication Type

From the **Type** drop-down list, select the method of communication between the site controllers and the Centaur Server computer. Use one of the following three methods:

# CENTAUR

## Integrated Access Control V8.0

### Direct (Serial Port)

Select this method if this is a local site that will communicate with the Centaur Server computer through the COM or USB port. After selecting **Direct (Serial Port)**, you are required to further set the site properties. See “Selecting the Site Baud Rate” on page 40, “Selecting the Site Speed” on page 40, “Selecting the Site Communication Schedule” on page 40 and “Assigning COM Ports to Controller Addresses” on page 40. All other settings will be unavailable.

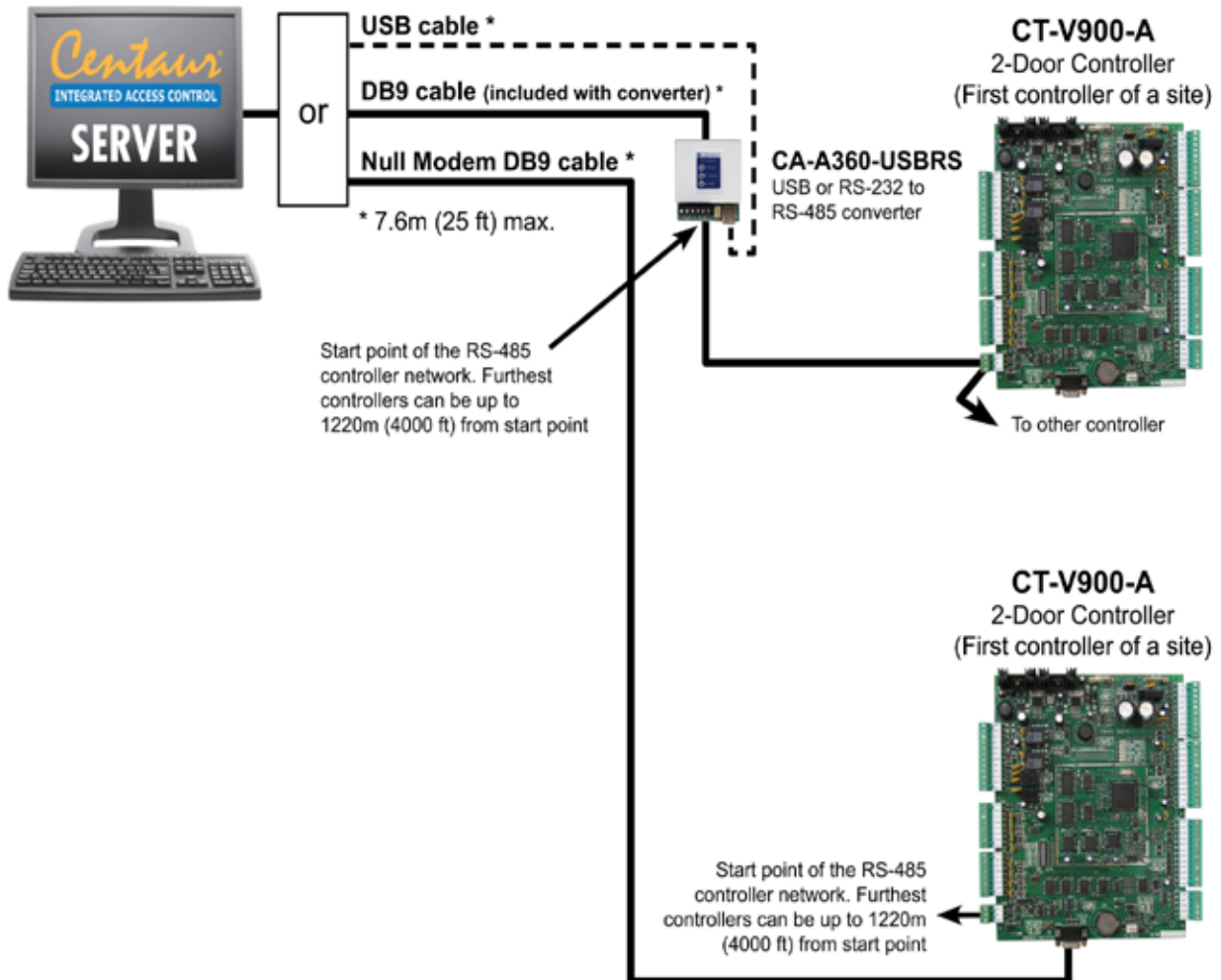

# CENTAUR

## Integrated Access Control V8.0

### Dialup (Modem)

Select this method if this is a remote site that will communicate with the Centaur Server computer through a modem. After selecting **Dialup (Modem)**, you are required to further set the site properties. See “Selecting the Site Speed” on page 40, “Selecting the Site Communication Schedule” on page 40, “Assigning Dial-up Site Telephone Number” on page 41 and “Assigning the Dial-up Site Modem Type” on page 41. If you do not set these properties, you will not be able to exit the **Site Properties** window. All other settings will be unavailable.

Figure 1: Dial-up Site

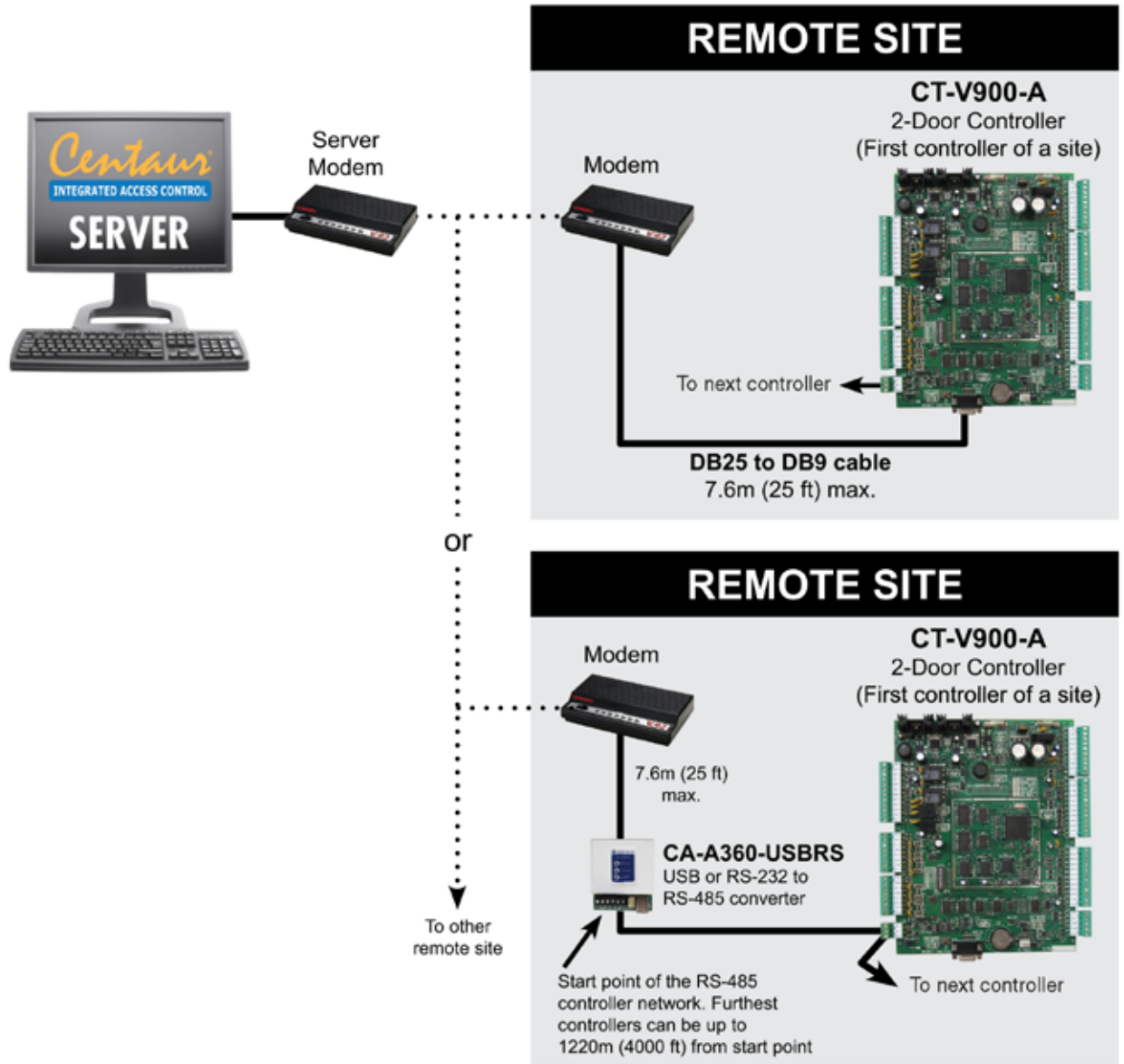

Using the Dialup connection method limits the amount of controllers to 64.

# CENTAUR

## Integrated Access Control V8.0

### TCP/IP (LAN/WAN)

Select this method to have a site that communicate over a TCP/IP network. To do so, you must connect one or more TCP/IP converter (CA-ETHR-A) as shown in "Figure 2". The CA-ETHR-A converts the RS-232 communication protocol into the TCP/IP protocol. After selecting **TCP/IP (LAN/WAN)**, you are required to further set the site properties. See "Selecting the Site Speed" on page 40, "Selecting the Site Communication Schedule" on page 40 and you must also set the TCP/IP communication settings of each controller as detailed in "Configuring the Controller Communication Settings" on page 106. All other settings will be unavailable.



The CA-ETHR-A converter is recommended as it has been tested with our products. Visit our website at [www.cdvi.ca](http://www.cdvi.ca) for more information.

Figure 2: TCP/IP Connection

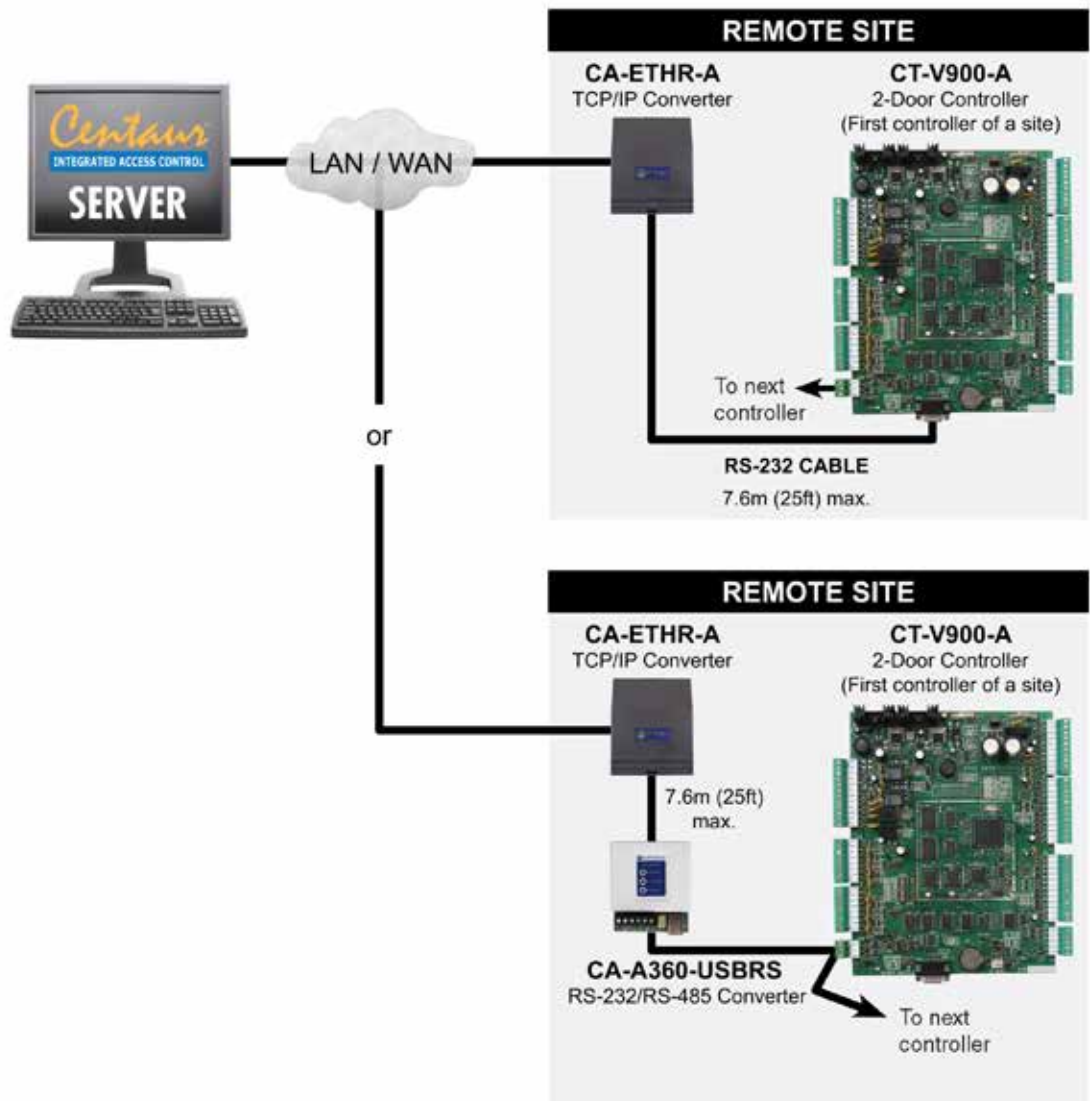

# CENTAUR

## Integrated Access Control V8.0

### Selecting the Site Baud Rate

It is important that the baud rate be set to the same value that is defined by the dip switch settings (#7) of the controllers (the controller default setting is 19200 baud) in the site. Click the **Baud Rate** drop-down list, and then select the appropriate baud rate from the list. This setting will only be available if the selected communication type is **Direct (Serial Port)** and the site is not connected.

### Selecting the Site Speed

Click the **Speed** drop-down list, then select the appropriate speed from the list. This setting defines the speed of data transfer between the Centaur Server computer and the site controllers. During normal operation, the speed should be set to **Fast**.

### Selecting the Site Communication Schedule

A site can be programmed to automatically communicate with the controllers (go online) according to a schedule. When the schedule becomes valid, the Centaur Server computer will automatically connect with the site until the schedule expires. Click the **Schedule** drop-down list and select the desired schedule from the list. For more information, refer to “Schedule Periods” on page 94.

### Assigning COM Ports to Controller Addresses

Each site can support up to 256 controllers (Enterprise edition). The 256 controllers are divided into four controller loops of up to 64 controllers each. Each of these loops must be assigned to a specific COM port.

- From the **COM Port 1 (CTL 1-64)** list, select a COM port. Controllers connected to the selected COM port will be assigned addresses 1 to 64 (controller’s DIP switch setting).
- From the **COM Port 2 (CTL 65-128)** list, select a COM port. Controllers connected to the selected COM port will be assigned addresses 65 to 128 (controller’s DIP switch setting + 64).
- From the **COM Port 3 (CTL 129-192)** list, select a COM port. Controllers connected to the selected COM port will be assigned addresses 129 to 192 (controller’s DIP switch setting + 128).
- From the **COM Port 4 (CTL 193-256)** list, select a COM port. Controllers connected to the selected COM port will be assigned addresses 193 to 256 (controller’s DIP switch setting + 192).

Refer to “Viewing the Controller Address” on page 88 for additional information on controller DIP switches and addresses. This setting will only be available if the selected communication type is **Direct (Serial Port)** and an **Enterprise** hardlock key edition is detected.

# CENTAUR

## Integrated Access Control V8.0

Figure 3: Example of COM Port Assignment

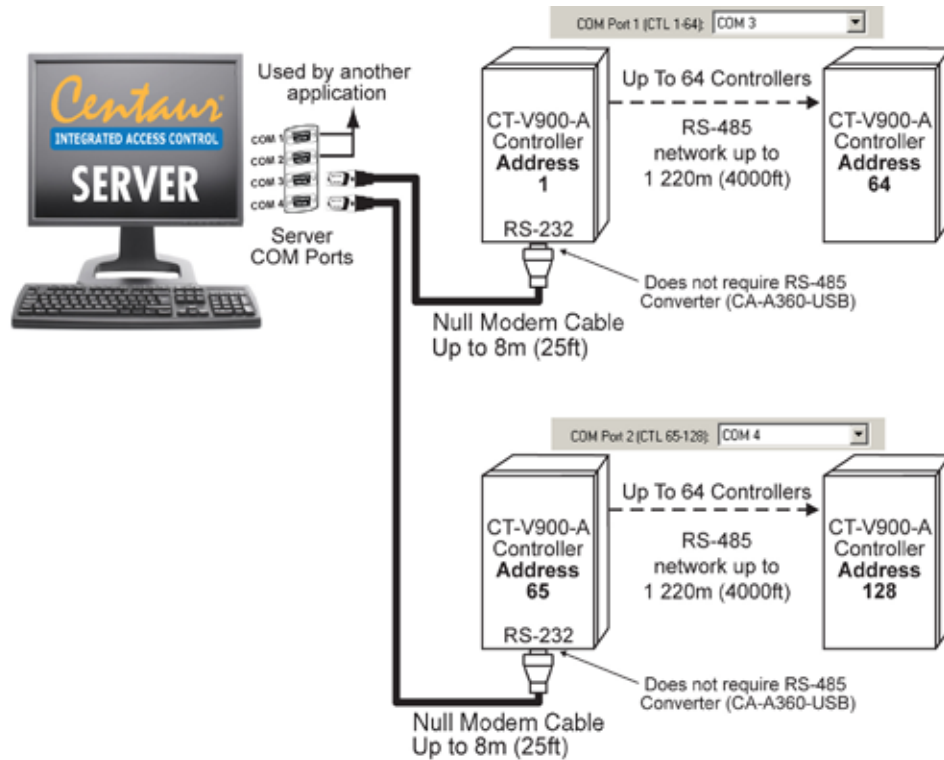

### Assigning Dial-up Site Telephone Number

If the selected communication type is **Dialup (Modem)**, type the dial-up site telephone number in the **Phone Number** text box. When attempting to connect, the Centaur Server computer will dial the number recorded here and will try to communicate with the remote site through a modem.

Figure 4: Example of Dial-up Site

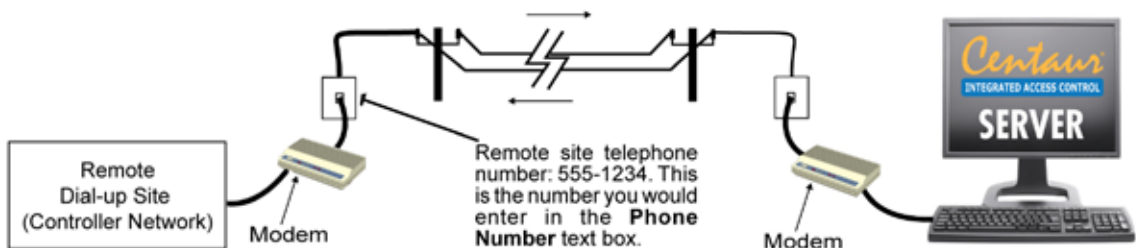

### Assigning the Dial-up Site Modem Type

If the selected communication type is **Dialup (Modem)**, from the **Modem** drop-down list, select the Centaur Server computer modem that will be used to communicate with the controller network. We recommend to use US Robotics 56k hardware modems (WIN modem are not supported).

# CENTAUR

## Integrated Access Control V8.0

### Updating the Controller Time Automatically

Select the **Update CTL time automatically every 15 minutes** check box to download the date and time from the PC to all controllers in the site every 15 minutes. Clear the check box if you wish to disable automatic date and time update. This check box is selected by default.

### Enabling Offline Buffering (Outbox)

Select the **Enable Offline Buffering (Outbox)** check box if you want Centaur to automatically store any system modifications performed while disconnected from the site (controllers offline) to an outbox table. Stored modifications are automatically downloaded to the controller(s) when communication is established with the site (controllers online).

## Site User/Card Settings

Select the **Users/Cards** tab from the **Site Properties** window. Each site can be programmed with different user/card settings.

### Hexadecimal Card Numbers

When the **Hexadecimal Card Numbers** check box is selected, the card numbers are entered using the hexadecimal format. When this check box is cleared, the decimal format is used. This setting will also be used when displaying the card numbers in the **Real-Time Events/Status window**. From the list beside the **Hexadecimal Card Numbers**, select the type of the card [26 Bits (6 Digits) or 30 Bits (7 Digits)] that will be used by the controller.

### Enabling the Use of Unique PIN Numbers

When you select the **Unique PIN Numbers** check box, Centaur will **not** allow you to create a duplicate PIN. If you wish to use duplicate PINs, clear the **Unique PIN Numbers** check box. Also refer to "P.I.N." on page 143.

### Enabling Distributed Card Programming

Select the **Distributed Card Programming** check box if you want Centaur to download only the cards that are required by each controller, which is determined by each card's assigned access level. This increases the number of cards available in your controllers since less data is being stored in the database. For example, if your system has 50 controllers and a card's assigned access level contains only two doors—both from the same controller—then Centaur only downloads that card to one controller instead of all 50 controllers. If you clear the **Distributed Card Programming** check box, Centaur sends all cards to all controllers in the system.

### Extended Access Levels (Levels 3/4)

By default, up to two access levels can be assigned to each card. If two access levels are assigned to a card, access is granted as long as one of the two access levels is valid when the card is presented (refer to "Access Level" on page 134). Selecting **Extended Access Levels (Levels 3/4)** check box will allow up to four access levels. The extended access levels feature requires firmware R2-C3-70 and higher in order to function correctly.

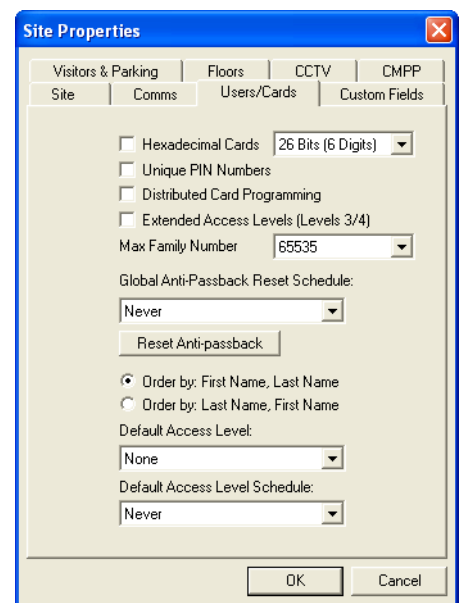

# CENTAUR

## Integrated Access Control V8.0

### Selecting the Cards Maximum Family Number

Each access card has a unique number consisting of two parts. The Family Number is always the first part of the number and is usually followed by a colon (e.g. **247:1234**) and the card number. The family number can be found printed directly on the card or written on the box label. From the **Maximum Family Number** drop-down list, select the appropriate value as detailed below.

**Table 1:** Selection of the cards maximum family number

MAXIMUM FAMILY NUMBER VALUE	LENGTH OF THE FAMILY CODE
0	No family code
255	Family code at 1 Octet
65,535	Family code at 2 Octets
16,777,215	Family code at 3 Octets
4,294,967,295	Family code at 4 Octets

### Selecting a Site's Global Anti-Passback Reset Schedule

In the **Global Anti-passback reset schedule** list, select the schedule that will reset the global anti-passback status of all users to **unknown**. This applies only to doors set as **Global Entry** or **Global Exit** (see "Global Entry or Global Exit" on page 108) and does not apply to the local anti-passback status of the controller (see "Controller Anti-passback Settings" on page 96). The reset occurs at the start of every period in the selected schedule (refer to "Schedule Periods" on page 81) or when clicking on the **Reset Anti-passback** button.

### Reset Anti-passback

The **Reset Anti-passback** button is used to manually reset the global anti-passback status of all users to **unknown**. This applies only to doors set as **Global Entry** or **Global Exit** (see "Global Entry or Global Exit" on page 108) and does not apply to the local anti-passback status of the controller (see "Controller Anti-passback Settings" on page 96).

### Selecting the User Ordering criteria

The **Order by: First Name, Last Name** and **Order by: Last Name, First Name** radio buttons are used to set how the users will be displayed in the Database Tree View window and in FrontDesk. The default setting is **Order by: First Name, Last Name**.

### Default Access Level

The **Default Access Level** allows the selection of an access level that will be automatically assigned when a card is added to this site. See "Cards" on page 125 for more information. The default setting is **None**.

### Default Access Level Schedule

The **Default Access Level Schedule** allows to select the schedule that will be automatically assigned when a new access level is added to this site. See "Access Levels" on page 121 for more information. The default setting is **Never**.

# CENTAUR

## Integrated Access Control V8.0

### Custom Fields

#### Defining the User Custom Fields

Customize the text field headings that appear in the **Custom Fields** tab of the **User Properties** window. Refer to “Custom Fields” on page 50 for more information.

- The text you type in the **Text 1** to **Text 12** text fields will appear next to the first twelve text fields, respectively, in the **Custom Fields** tab of a user.
- The text you type in the **Date 1** to **Date 4** text fields will appear next to the four date fields respectively, in the **Custom Fields** tab of a selected user.
- The text you type in the **T/F 1** to **T/F 4** text fields will appear next to the four check boxes respectively, in the **Custom Fields** tab of a selected user.



**Example:** The “Figure 5” shows the results of the defined User Definable Card Fields on the **User Properties - Custom Fields** window.

Figure 5: User Custom Fields

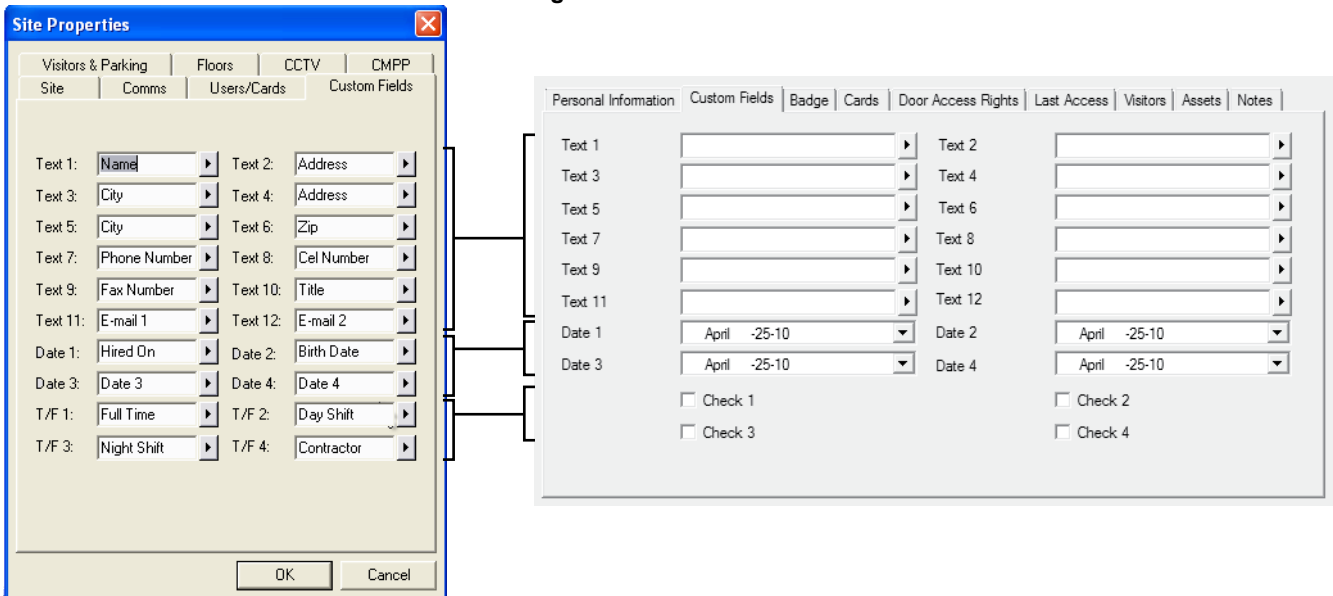

# CENTAUR

## Integrated Access Control V8.0

### Visitors & Parking

The **Visitors & Parking** tab allows to set the default site visitor sign-out rules and parking capacity rules.

**Visitor Options:**

#### Disable visitor’s card(s) upon departure

Visitor’s cards will be denied access upon departure. Visitor’s cards must be re-enabled to grant access upon the next sign-in. The card remains with the visitor when he leaves.

#### Unassign visitor’s card(s) upon departure

Visitor’s cards will become available to new visitors. A card must be assigned at next sign-in. The card is returned to the host or security guard.

#### Require signature upon departure

Visitors must electronically sign out when leaving (returning visitor card).

#### Default Host

Allows the selection of the user that will be assigned as the default host for all visitors that will be created.

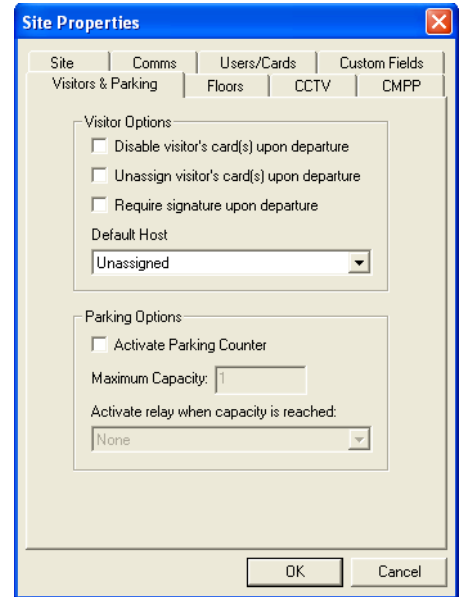

**Parking Options:**

#### Activate Parking Counter

Allows to keep track of the number of cars present in the parking.

#### Maximum Capacity

Allows to limit the number of cars present in the parking.

#### Activate relay when capacity is reached

Allows the selection of the relay that will be activated when the capacity of the parking is reached.

# CENTAUR

## Integrated Access Control V8.0

### Site Floor Settings

Select the **Floors** tab from the **Site Properties** window. The first step in setting up elevator control is to define the number of floors in each site and to give a name to each of these logical floors. Up to 64 floors can be controlled per site.

#### Number of Floors

Define the number of floors that need to be controlled for the selected site by typing a value between 01 and 64 in the **Number of floors** text field.

#### Floor Name

Right-click the desired floor, select **Rename**, type the desired name and press the keyboard **Enter** key. Please keep in mind that when setting up elevator control, the floors always refer to a building's logical floors and not their named floors as shown in "Figure 6".

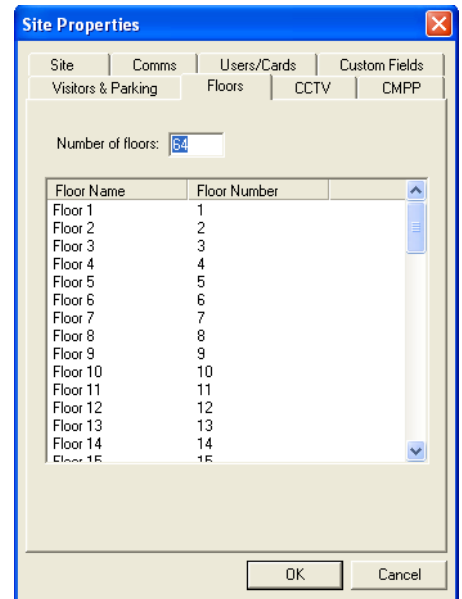
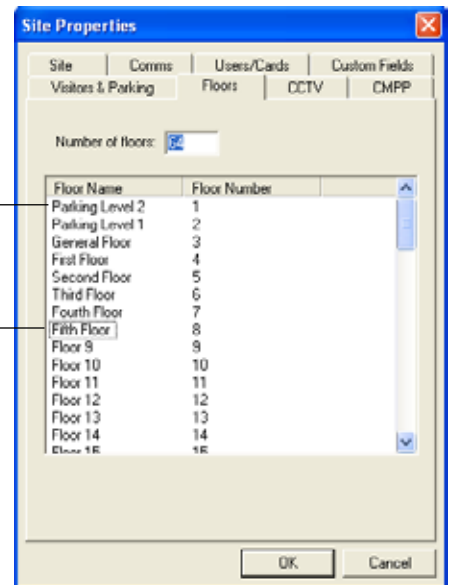

Figure 6: Building's logical floors

Logical Floor #8	(5) Fifth Floor
:	(4) Fourth Floor
:	(3) Third Floor
:	(2) Second Floor
:	(1) First Floor
:	(G) General Floor
:	(SB1) Parking Level 1
:	(SB2) Parking Level 2
Logical Floor #1	



# CENTAUR

## Integrated Access Control V8.0

### Site CCTV Port Settings

If a site requires CCTV control, you must activate CCTV control to define through which COM port the CCTV commands will be sent and what communication settings the COM port will use. Select the **CCTV** tab from the **Site Properties** window.

#### Activating CCTV Control for a Site

Select the **Activate CCTV Control** check box if you want Centaur to process CCTV commands. Whenever an event occurs that is assigned a CCTV command (refer to “Selecting the CCTV Command for an Event” on page 182), Centaur transmits the CCTV command to the video switcher connected to the selected COM Port. If you do not activate CCTV Control, Centaur ignores any CCTV command assigned to system events.

#### Selecting a Computer COM Port for CCTV

From the **COM Port** drop-down list, select the computer COM port used to communicate the CCTV commands to the video switcher. Connect the video switcher to the selected COM port. The selected COM port will use the communication settings defined by the **Baudrate**, **Data Bits**, **Parity**, **Stop Bits**, and **Flow Control** lists.

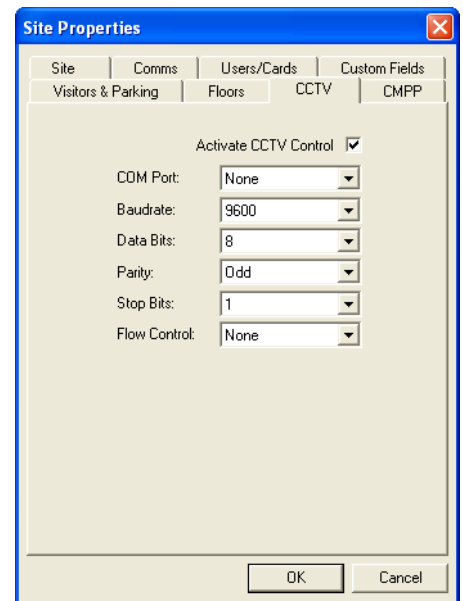

#### Selecting a Video Switcher Baudrate

In the **Baudrate** list, select a baudrate that is compatible with the video switcher connected to the selected COM port.

#### Setting the COM Port Communication Parameters

Select the required data bits, parity, stop bits, and flow control settings to communicate with the video switcher connected to the selected COM port. Set the following parameters as required:

##### *Data Bits*

From the **Data Bits** drop-down list, select the number of data bits required to communicate with the video switcher connected to the selected COM port. This value is the number of bits used to represent one character of data. Most forms of data require eight bits.

##### *Parity*

From the **Parity** drop-down list, select a parity value that is required to communicate with the video switcher connected to the selected COM port. Parity check is an error detection technique that tests the integrity of digital data within the computer system or over a network. Each time a byte is transferred or transmitted, the parity bit is tested.

##### *Stop Bits*

From the **Stop Bits** drop-down list, select the number of stop bits required to communicate with the video switcher connected to the selected COM port. The stop bit is transmitted after each character.

##### *Flow Control*

From the **Flow Control** drop-down list, select the flow control type required to communicate with the video switcher connected to the selected COM port. Flow control determines the timing of signals and enables slower-speed devices to communicate with higher-speed devices. There are various techniques, but all are designed to ensure that the receiving station is able to accept the next block of data before the sending station sends it.

# CENTAUR

## Integrated Access Control V8.0

### Activating and Configuring CMPP Card Enrollment Station

The CMPP feature allows using a card enrollment station that reads a card/badge and automatically shows the card number (“Hexadecimal Card Numbers” on page 42). If a site requires CMPP, you must activate CMPP to define the card type and through which COM port the CMPP commands will be sent and what communication settings the COM port will use. Select the **CMPP** tab from the **Site Properties** window.

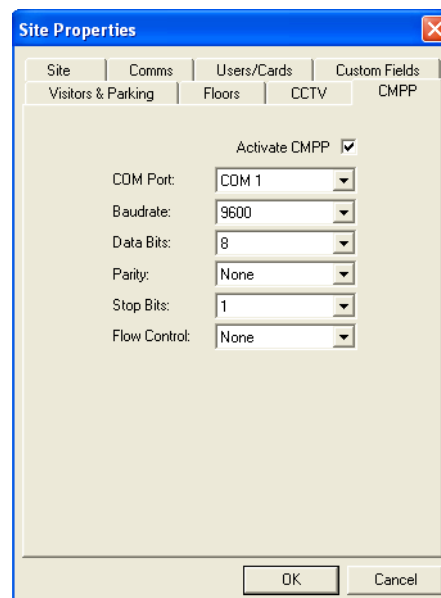

#### Activating CMPP for a Site

Select the **Activate CMPP** check box to allow Centaur to use CMPP card enrollment station capability.

#### Selecting a Computer COM Port for CMPP

From the **COM Port** drop-down list, select the computer COM port used to communicate the CMPP commands to the card enrollment unit. Connect the card enrollment unit to the selected COM port. The selected COM port will use the communication settings defined by the **Baudrate**, **Data Bits**, **Parity**, **Stop Bits**, and **Flow Control** lists.

#### Selecting a card enrollment unit Baudrate

In the **Baudrate** list, select a baudrate that is compatible with the card enrollment unit connected to the selected COM port.

#### Setting the COM Port Communication Parameters

Select the required data bits, parity, stop bits, and flow control settings to communicate with the card enrollment unit connected to the selected COM port. Set the following parameters as required:

##### *Data Bits*

From the **Data Bits** drop-down list, select the number of data bits required to communicate with the card enrollment unit connected to the selected COM port. This value is the number of bits used to represent one character of data. Most forms of data require eight bits.

##### *Parity*

From the **Parity** drop-down list, select a parity value that is required to communicate with the card enrollment unit connected to the selected COM port. Parity check is an error detection technique that tests the integrity of digital data within the computer system or over a network. Each time a byte is transferred or transmitted, the parity bit is tested.

##### *Stop Bits*

From the **Stop Bits** drop-down list, select the number of stop bits required to communicate with the card enrollment unit connected to the selected COM port. The stop bit is transmitted after each character.

##### *Flow Control*

From the **Flow Control** drop-down list, select the flow control type required to communicate with the card enrollment unit connected to the selected COM port. Flow control determines the timing of signals and enables slower-speed devices to communicate with higher-speed devices. There are various techniques, but all are designed to ensure that the receiving station is able to accept the next block of data before the sending station sends it.

# CENTAUR

## Integrated Access Control V8.0

### DELETING A SITE

To delete an existing site, from the Database Tree View window, right-click the desired site from the **Sites** branch, and select **Delete**. You can also select the desired site and press the keyboard **Delete** key.

### COMMUNICATING WITH A SITE

In order to communicate with a site, you must first successfully connect to the site (go online). To do so successfully, the appropriate connections between the controllers and the Centaur Server computer must be completed. Also, the site's communication settings must be programmed appropriately as described in "Site Communication Settings" on page 36. The communication settings of each controller in the site must also be programmed appropriately as detailed in "Configuring the Controller Communication Settings" on page 106.

#### Connecting to a Site or Disconnecting from a Site

Perform the following to connect (go online) to a site or disconnect (go offline) from a site:

1. From the Database Tree View window, right-click the desired site from the **Sites** branch, and click **Connect** or **Disconnect**.
2. Observe the communication status as demonstrated by the colour of the site Direct, Dial-Up, or TCP/IP icon in the Database Tree View window and the colour of the message in the status bar.

COMMUNICATION STATUS	COLOUR INDICATOR	ICON TREE VIEW WINDOW			STATUS BAR
		Direct	Dial-Up	TCP/IP	
Disconnected (Offline)	Red				Comms Off
Communication Failure	Yellow				Comms Fail
Connected (Online)	Green				Comms Ok



If you wish to connect to a site for continuous communication, select the **Always** schedule in the **Comms** tab of the **Site Properties** window. Refer to "Selecting the Site Communication Schedule" on page 40

# CENTAUR

## Integrated Access Control V8.0

### Using SAP Integration

Each site may be configured to use SAP integration which will allow automatic user/visitor import from SAP generated file.

To enable and configure the use of SAP integration, from the Database Tree View window, right-click the desired site from the **Sites** branch, and select **SAP Integration**.

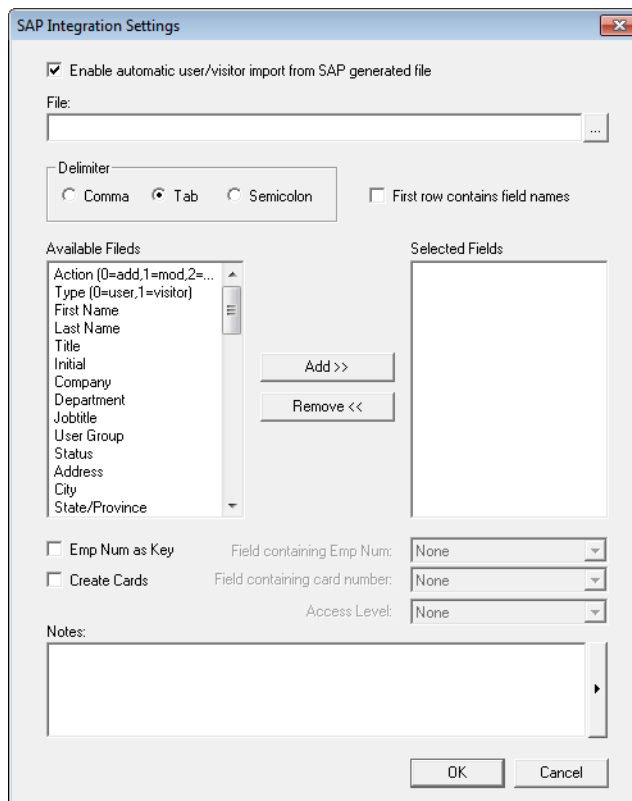

#### *Enable automatic user/visitor import from SAP generated file*

Select the **Enable automatic user/visitor import from SAP generated file** check box to enable the use of SAP integration.

#### *File*

Select the CSV **File** that will contain the new user/visitor informations.

#### *Delimiter*

Select the delimiter format use to separate field within the CSV file. Choices are Comma, Tab or Semicolon.

#### *First row contains field names*

Select the **First row contains field names** if the first row of the CSV file contain the name of the fields.

#### *Available Fields and Selected Fields*

Select the desired fields from left column by either double-clicking on each field or by clicking on each field then on the **Add** button to add the field to the selected fields column. Only field appearing in the right column will use for user/visitor import from SAP file. To remove a field from the selected list, click on the field from the selected field column then on the Remove button. Selected fields must be in the same order as in the SAP generated file.

# CENTAUR

## Integrated Access Control V8.0

### *Emp Num as Key*

Select the **Emps Num as Key** check box to assign a unique employee number for each user/visitor.

### *Field containing Emp Num*

Select the field that will be used to contain the employee number (**Emp Num as Key**). Available when the **Emp Num as Key** check box is selected.

### *Create Cards*

Select the **Create Cards** check box to automatically create a card number for the user/visitor.

### *Field containing card number*

Select the field that will be used to contain the employee card number. Available when the **Create Cards** check box is selected.

### *Access Level*

Select the field that will be used to contain the employee card access level. Available when the **Create Cards** check box is selected.

### *Notes*

Use the **Notes** text field to record any additional notes that may be required. We recommend that you keep a log of what settings were changed and when they were changed. Also, refer to “Typing Names and Notes” on page 30.

# CENTAUR

## Integrated Access Control V8.0



## SMTP

### What Will I Find?

---

The Simple Mail Transfer Protocol, commonly abbreviated SMTP, is the communications protocol used to transfer email to the email servers with CENTAUR.

# CENTAUR

## Integrated Access Control V8.0

### SMTP CONFIGURATION

In the Centaur database tree, right-click on the Site Name and select SMTP Settings

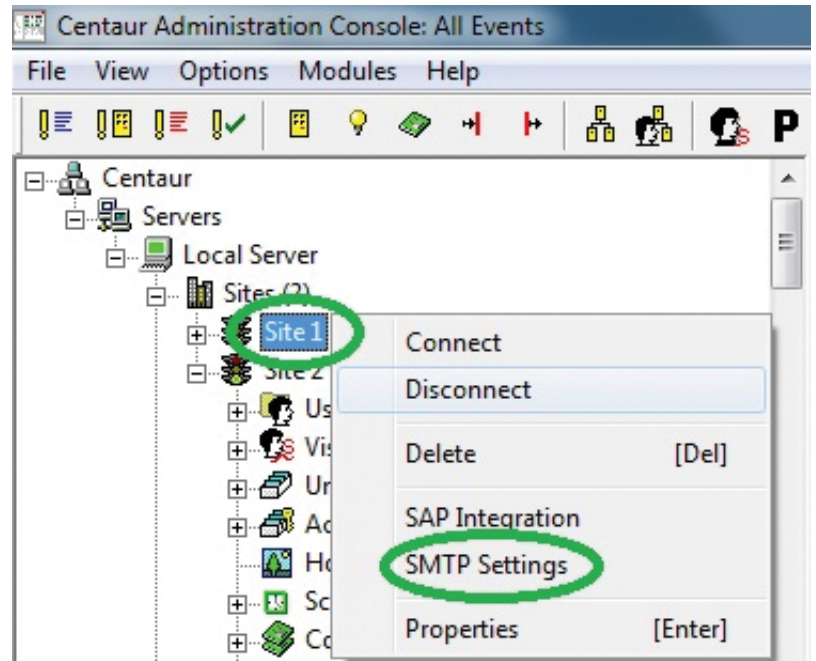

# CENTAUR

## Integrated Access Control V8.0

### USING A GMAIL ACCOUNT TO SEND AN EMAIL

#### User Information section

**Name:** Person responsible for the email account used to send emails (e.g John Doe)

**E-mail Address:** Email address/account to send emails (e.g johndoe@gmail.com)

#### Server Information section

**Outgoing mail server (SMTP):** smtp.gmail.com

**Port:** 587

**Secure Connection (SSL/TLS):** enabled

#### Logon Information section

**User Name:** your Gmail email address (e.g johndoe@gmail.com)

**Password:** your Gmail account password

**Requires Authentication:** enabled

#### Custom Header Section (optional)

**By default, the first line of text in an email sent by Centaur is as follows:** This e-mail was auto-generated by the Centaur Access Control Server.

This can be modified. To do so, enter the text that will appear at the beginning/top of the email (e.g service company name and telephone number).

The screenshot shows the 'SMTP Settings' dialog box with the following configuration:

- User Information:** Name: John Doe; E-mail Address: johndoe@gmail.com
- Server Information:** Outgoing mail server (SMTP): smtp.gmail.com; Port: 587; Secure Connection (SSL/TLS):
- Logon Information:** User Name: johndoe@gmail.com; Password: [masked]; Requires Authentication:
- Custom Header:** [Empty text area]

# CENTAUR

## Integrated Access Control V8.0

### USING A YAHOO ACCOUNT TO SEND AN EMAIL

#### User Information section

**Name:** person responsible for the email account used to send emails (e.g John Doe)

**E-mail Address:** email address/account to send emails (e.g johndoe@yahoo.com)

#### Server Information section

**Outgoing mail server (SMTP):** smtp.mail.yahoo.com

**Port:** 587

**Secure Connection (SSL/TLS):** enabled

#### Logon Information section

**User Name:** your Yahoo email address (e.g johndoe@yahoo.com)

**Password:** your Yahoo account password

**Requires Authentication:** enabled

#### Custom Header Section (optional)

**By default, the first line of text in an email sent by Centaur is as follows:** This e-mail was auto-generated by the Centaur Access Control Server.

This can be modified. To do so, enter the text that will appear at the beginning/top of the email (e.g service company name and telephone number).

## USING A HOTMAIL/WINDOWS LIVE ACCOUNT TO SEND AN EMAIL

### User Information section

**Name:** person responsible for the email account used to send emails (e.g John Doe)

**E-mail Address:** email address/account to send emails Using a Hotmail/Windows Live account to send an email

### Server Information section

**Outgoing mail server (SMTP):** smtp.live.com

**Port:** 587

**Secure Connection (SSL/TLS):** enabled

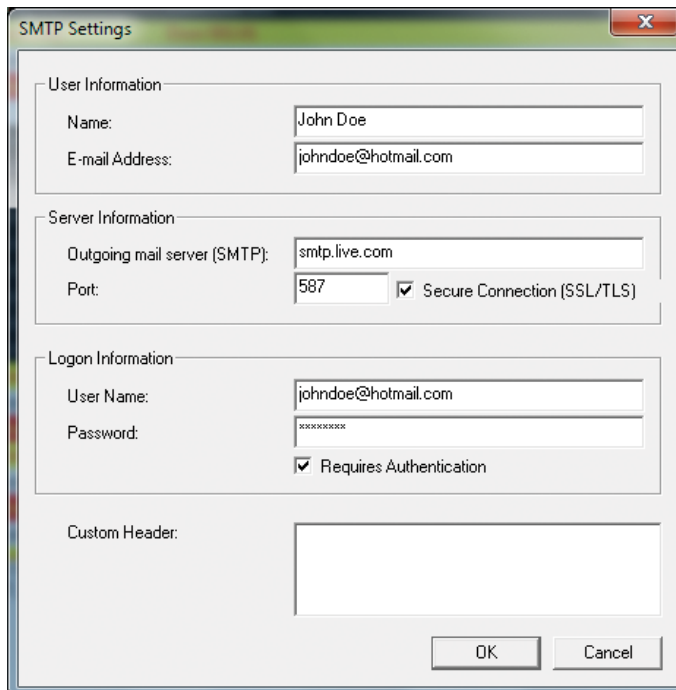

### Logon Information section

**User Name:** your Hotmail/Windows Live email address (e.g johndoe@hotmail.com or johndoe@live.com)

**Password:** your Hotmail/Windows Live account password

**Requires Authentication:** enabled

### Custom Header Section (optional)

**By default, the first line of text in an email sent by Centaur is as follows:** This e-mail was auto-generated by the Centaur Access Control Server.

This can be modified. To do so, enter the text that will appear at the beginning/top of the email (e.g service company name and telephone number).

# CENTAUR

## Integrated Access Control V8.0

### EMAIL NOTIFICATION CONFIGURATION

Let CENTAUR send an email when an event happens! Alarm events such as door forced open, door open to long, controller communication failiure, low battery, input in alarm, etc. In effect, an email can be sent when any event occurs. Additionally, you can choose when an email will be sent. For example, send an email if an event occurs at night or on the weekend but not send an email if the event occurs on week day.

These settings are also used with the new "Pickup" feature now available in CENTAUR.

In the CENTAUR database tree, expand "**Events**" and right-click on the specific event you want to receive an email and select "**Properties**"

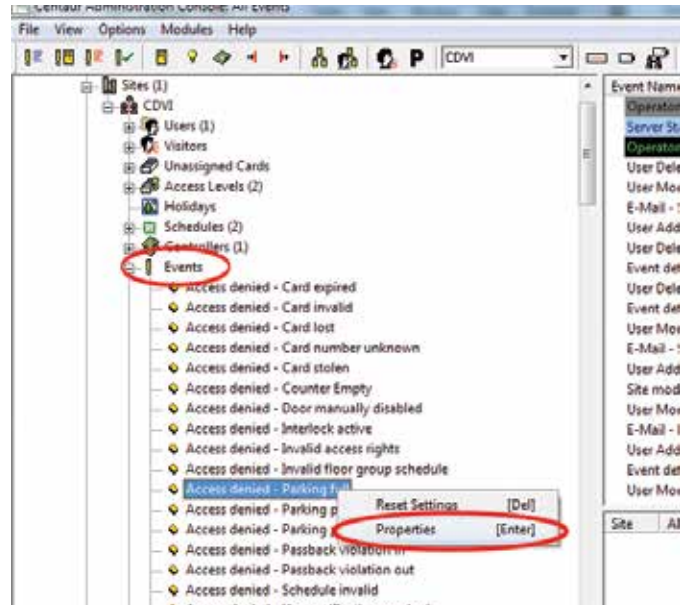

### EVENT PROPERTIES

**Settings for:** Select from which device the email should be send (Default= any devices).

**Card Holders:** Select from which card holder the email should be send (Default= any card holder).

#### Email Tab

**Send E-Mail:** enabled

**Schedule:** Select from which schedule the email should be send.

**To:** Enter the email of the person who will receive the notification (e.g johndoe@gmail.com)

**Cc:** Enter the email of the person who will receive a carbon copy of the notification(e.g marydoe@gmail.com)

**Bcc:** Enter the email of the person who will receive a blind carbon copy of the notification. "To" and "Cc" won't know that person receive the notification.

**HTML:** When enable will send email in HTML format

**Short format (Mobile):** When enable will send email in short format (SMS). By default none of them are check and will send email in "Rich Text" format

**Message:** Enter an optional message

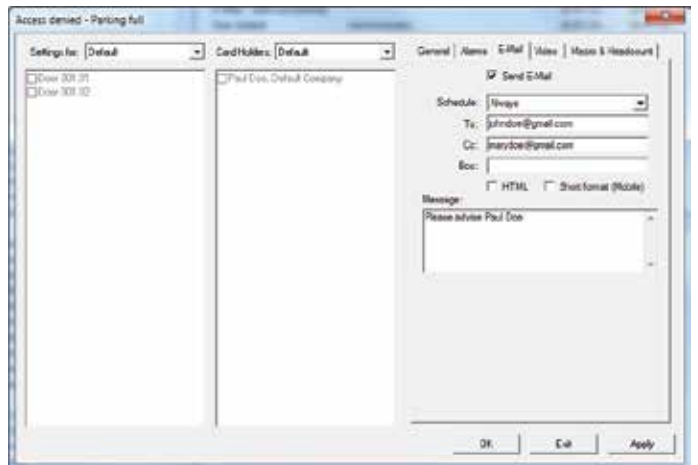

# CENTAUR

## Integrated Access Control V8.0



## Users and User Groups

### What Will I Find?

---

Programming a user allows you to define the details pertaining to the user. Any individual that needs to access a door must be defined in the system as a user. Once defined, a card can be assigned to a user.

# CENTAUR

## Integrated Access Control V8.0

### ADDING USERS

In the Database Tree View window, right-click **Users** from the desired Site branch and click **New User**. You can also select **Users** and press the keyboard **Insert** key. The user properties window will appear, allowing you to configure the user properties. Refer to "Modifying a User" on page 60 for more information.

Also, refer to "FrontDesk" on page 75.

The screenshot shows the 'User Properties' dialog box with the following data:

First Name:	Joe	Group:	Unassigned
Last Name:	Smith	Location:	Unknown
Title:	Mr.	Status:	Valid
Company:	CDVI	Start Date:	25/04/2010 1:20:56 PM
Department:	Default Department	End Date:	25/04/2010 1:20:56 PM
Jobtitle:	Default JobTitle	Text 1:	

Additional fields in the 'Personal Information' tab include Address, City, State/Province, Country/Region, ZIP/Postal Code, Phone, E-Mail, and Signature.

## MODIFYING A USER

From the desired Site branch in the Database Tree View window, right-click the user you wish to modify and click **Properties** from the drop-down list. You can also select the desired user and press the keyboard **Enter** key. Also, refer to “FrontDesk” on page 75.

### General User Properties

#### First Name and Last Name

The **First Name** and **Last Name** are used to identify the user and will be used in the Users branch of the Database Tree View window for user identification.

#### Title

Allows the selection of the user title.

#### Initial

Allows to enter the user initials.

#### Company

Allows the selection of the user company group. Refer to “Groups” on page 184 for more information.

#### Department

Allow the selection of the user department. Refer to “Groups” on page 184 for more information.

#### Jobtitle

Allows the selection of the user jobtitle. Refer to “Groups” on page 184 for more information.

#### Group

Allows the selection of the group the user belongs to. Refer to “Groups” on page 184 for more information.

#### Location

The **Location** drop list is used to indicate or change the global anti-passback status of a user: **In**, **Out** or **Unknown**. All user’s location is set to **Unknown** after a reset of the anti-passback. Refer to “Controller Anti-passback Settings” on page 109 for more information.

# CENTAUR

## Integrated Access Control V8.0

### Status

Allows the selection of the user status. Changing the status of the user will change the status of all cards associated to this user except for cards that are lost or stolen; the new status takes effect when clicking on the **Apply** button.

#### *Valid*

The user is valid and the user can begin using their card until the status is changed.

#### *Invalid*

This status allows you to indefinitely disable the user without having to delete the user from the database. As soon as you click **OK**, the user is no longer valid until their status is changed.

#### *Temporary*

You can use this status level to create a user prior to the date the user becomes valid or for personnel on contract which would require an access for a specific period of time. When you select **Temporary** from the **Status** drop-down list, the **Start Date**, **End Date** options become available. Use the **Start Date** and **End Date** drop-down lists to select the day, month, and year the user becomes valid and the day, month, and year the user expires. The user becomes active at 00:00 of the selected **Start Date** and expires at 24:00 of the selected **End Date**.

### Start Date and End Date

See “Temporary” above for more information.

### Text 1

Use the **Text 1** field to display one of the custom fields (see “Custom Fields” on page 63) that you would like to see in the general section of the user properties window. Once selected, the field name **Text 1** will be replaced by the selected field name. The information contained in the selected text field will be displayed here.

## Personal Information

From the **User Properties** window, select the **Personal Information** tab and use these fields to record any personal information about the user.

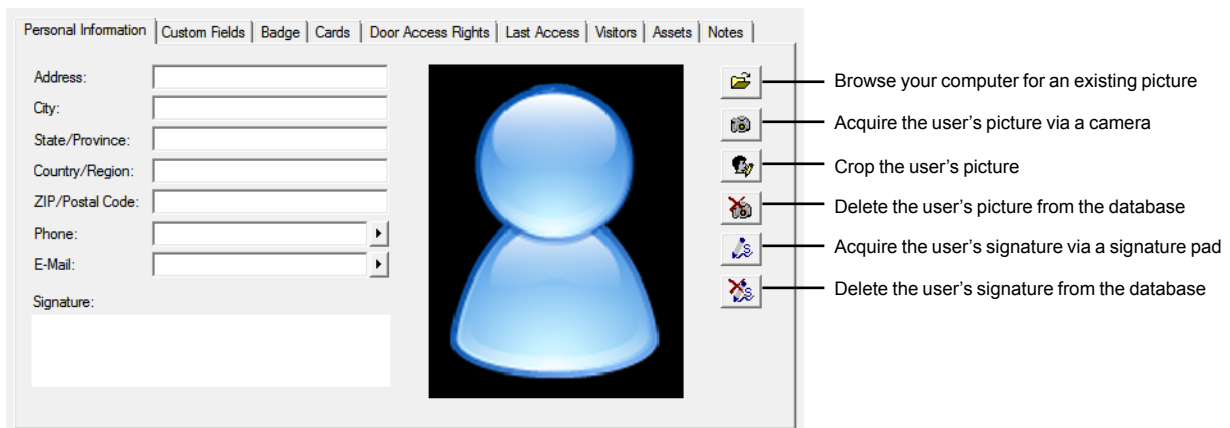

# CENTAUR

## Integrated Access Control V8.0

### User's Personal Information

Enter the user's **Address**, **City**, **State/Province**, **Country/Region**, **ZIP/Postal Code**, **Phone**, and **E-mail** information. Up to three **Phone** and **E-Mail** entries is available using the arrow at the right of the specific field. These fields are optional.

### User's Signature

You can associate a signature to a user which can be used for visual verification.

#### *Acquire the user's signature via a signature pad*

Click on this button to acquire the signature using a signature pad. Compatible signature pads are: Topaz Signature Gem and others...

#### *Delete the user's signature from the database*

Click on this button to remove the signature from the database.

### User's Picture

You can associate a picture to a user, which is commonly used with Centaur's visual authentication feature. When a user card is presented to a reader, Centaur's visual authentication software can display the user's picture. Use one of the following methods to associate a picture to the user.

#### *Browse your computer for an existing picture*

Allows selecting a picture on disk. Click on this button and select the picture file and click on **Open**.

#### *Acquire the user's picture via the camera*

Allows acquiring a picture from a camera or a scanner. Click on this button and select either **Video (Direct Show)** or **Scan (Twain)**.

#### *Crop the user's picture*

Allows cropping the picture proportionally. Click on this button and click-and-drag the appropriate corner(s) to reduce the picture.

#### *Delete the user's picture from the database*

Allows removing the user's picture from the database. Click on this button to remove the user's picture and replace it by the default picture.

# CENTAUR

## Integrated Access Control V8.0

### Custom Fields

From the **User Properties** window, select the **Custom Fields** tab and use these fields to record any additional information about the user. For information on how to customize the titles of these fields, refer to “Custom Fields” on page 63

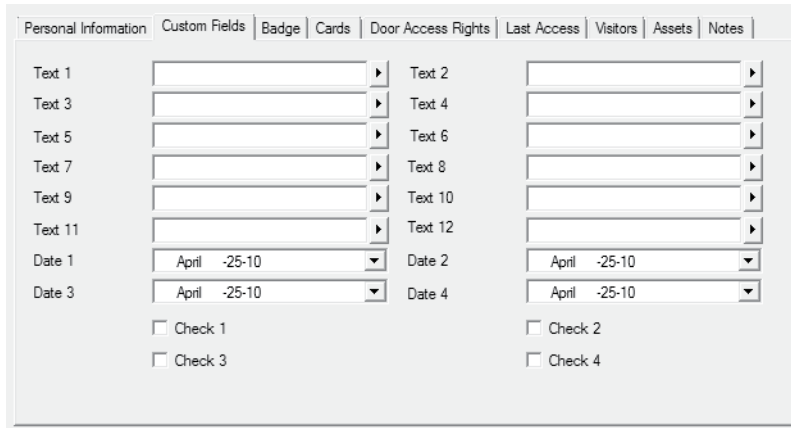

### Badge

The badge is used to define what will be printed directly on the front and back sides of the user access card.

1. From the user properties window, select the **Badge** tab.

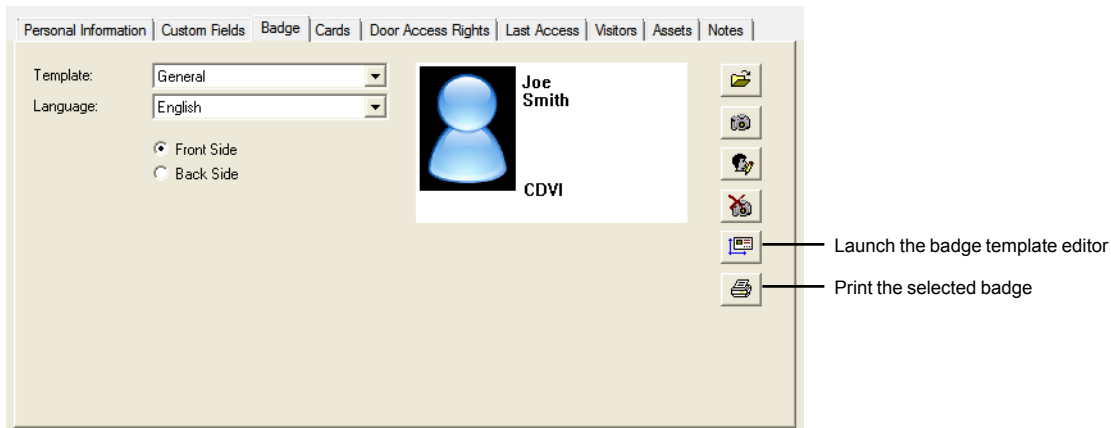

2. Select a **Template** from the list or use the **Launch the badge template editor** button to create a new template
3. Select the language to be used from the **Language of user defined text** drop list.
4. Select the front or back side preview to be displayed using the **Front Side** or **Back Side** radio buttons.

# CENTAUR

## Integrated Access Control V8.0

### Buttons

*Launch the badge template editor*

Allows defining the front and back side of the badge. See “Badge” on page 63 for more information.

*Print the selected badge*

Allows printing the defined user’s badge layout.

# CENTAUR

## Integrated Access Control V8.0

### Launching the Centaur Badge Editor

The **Centaur Card Template Designer** allows defining the front and back side of the badge.

5. To launch the editor, click on the **Launch Editor** button.
  - a) Select a template and click **Load** to open the selected template.
  - b) Click **New** to create a new template, enter the name of the template, and click **OK**.
  - c) Select a template and click **Rename** to rename the selected template.
  - d) Select a template and click **Delete** to delete the selected template.
  - e) Click **Cancel** to quit the editor.
  - f) Click **Import/Export** to import or export a card template to or from the Centaur's database. Click the **Import/Export** button, select **Export** or **Import**, and click **Next**. For export, select the file name to export to, press **Next**, select the template, and click **Finish**. For import, select the file name to import from, press **Next**, select the template, and click **Finish**.

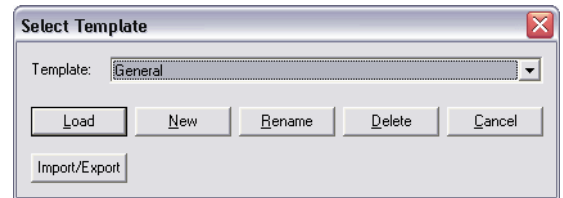

The **Centaur Card Template Designer** editor is displayed when you have selected to **Load** the selected template.

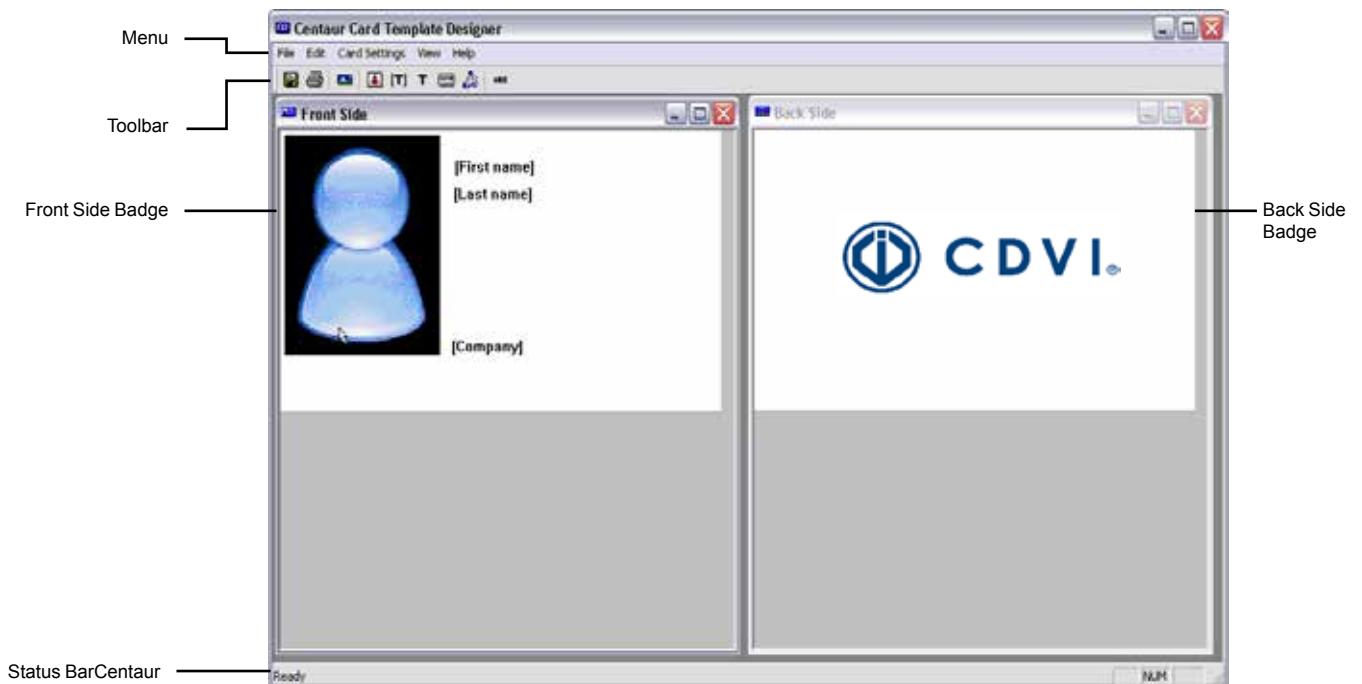

# CENTAUR

## Integrated Access Control V8.0

### Menu

The menu gives access to the **File**, **Edit**, **Card Settings**, **View**, and **Help** menus.

- The **File** menu gives access to the **Template** selection, **Save**, **Print**, and **Exit**.
- The **Edit** menu gives access to the following to add items to the template. For each item selected, click on the screen where the field needs to be located. Click and drag the inserted field to change its location on the badge.
  - **Add Photo**: Allows to add the photo to the badge template.
  - **Add Card Info**: Allows to add predefined card fields from the “General User Properties” on page 60 and “Personal Information” on page 61. Select a field from the **Card Data** drop list, and click **OK**.
  - **Add Static Text**: Allows to add static text to the badge template.
  - **Add Barcode**: Allows to add a barcode.
- The **Card Settings** menu gives access to the following:
  - **Background Image**: Allows to add a background image to the badge template. Select the background image for the Front and/or the Back of the badge, and click **OK**.
  - **Default Font**: Allows the selection of the font that will be used for the card fields inserted after the font selection. The **Default Font** does not affect the fields that are already inserted to the badge template.
  - **Flip (Portrait / Landscape)**: Allows to switch the editor layout from portrait to landscape or vice versa.
- The **View** menu gives access to the following:
  - **Toolbar**: Allows to show or hide the Toolbar.
  - **Status Bar**: Allows to show or hide the Status Bar.
  - **Show / Hide Front Side**: Allows to show or hide the card badge front side.
  - **Show / Hide Back Side**: Allows to show or hide the card badge back side.
  - **Tile Horizontally**: Allows to display the front side of the badge on top of the back side.
  - **Tile Vertically**: Allows to display the front side of the badge beside the back side.
  - **1 Front Side** and **2 Back Side**: Allows the selection of either the front side or the back for edition.
- The **Help** menu gives access to About Centaur Badge Editor window.

# CENTAUR

## Integrated Access Control V8.0

### Toolbar

The Toolbar is divided in different categories as described in the following picture.

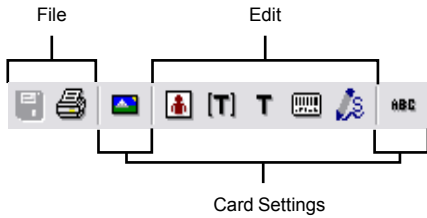

CATEGORY	BUTTON	DESCRIPTION	SHORTCUT KEY	MENU
File		Template Allows selecting a template.	Ctrl+L	File -> Template...
		Save Allows saving the template.	Ctrl+S	File -> Save
		Print Allows printing the template layout.		File -> Print
		Exit Allows to quit the <b>Centaur Card Template Designer</b> .		File -> Exit
Edit		Add Photo	Ctrl+P	Edit -> Add Photo
		Add Card Info	Ctrl+I	Edit -> Add Card Info
		Add Static Text	Ctrl+T	Edit -> Add Static Text
		Add Barcode	Ctrl+B	Edit - Add Barcode
		Add Signature		
Card Settings		Background Image	Ctrl+G	Card Settings -> Background Image...
		Default Font	Ctrl+D	Card Settings -> Default Font
		Flip (Portrait / Landscape)	Ctrl+F	Card Settings -> Flip (Portrait / Landscape)

### Status Bar

The status bar is located at the bottom portion of your screen and allows to display the Centaur Card Template Designer status.

# CENTAUR

## Integrated Access Control V8.0

### Cards

The Cards tab allows to assign card(s) to the user. From the user properties window, select the **Cards** tab. The card(s) associated to the user are listed in the **Cards** tab with its **Description**, **Family Number**, **Card Number**, **Status**, and **Access Level**. When a card is added, its status becomes the same as the one defined for the user.

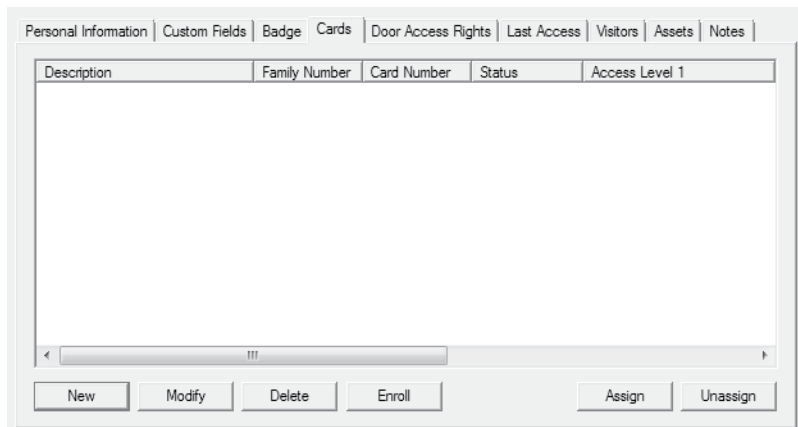

#### *New*

Allows to add a new card. See “Adding Cards” on page 140 for more information.

#### *Modify*

To modify the card information, click on **Modify** and see “Modifying a Card” on page 141 for more information.

#### *Delete*

To permanently delete the selected card from the database, select a card from the list and click **Delete**.

#### *Enroll*

Allows to select the bioscrypt reader and scan the use’s finger print.

- To select the bioscrypt reader either enter its IP address or click Find to select from the detected list. The Serial Number, Unit Type and Wiegand Format of the selected Bioscrypt are displayed. Click on OK.
- From the **Finger** drop list, select which finger will be scanned.
- Click **Enroll**.

#### *Assign*

To assign unassigned card(s) to the user, click the **Assign** button, select one or more cards that need to be assigned to the current user, and click **OK**.

#### *Unassign*

To unassign a card, select a card from the list and click **Unassign**.

# CENTAUR

## Integrated Access Control V8.0

### Door Access Rights

Gives the list of all doors the user has access to. The door's **Access Level**, **Schedules**, **Description**, **Status**, **Family Number**, and **Card Number** are also displayed.

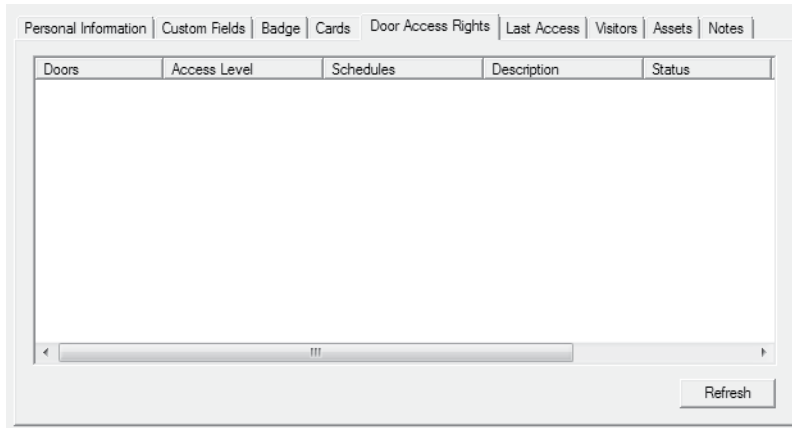

### Last Access

Lists the user's last 25 access events. The **Events**, **Field Time**, and **Doors** information are displayed.

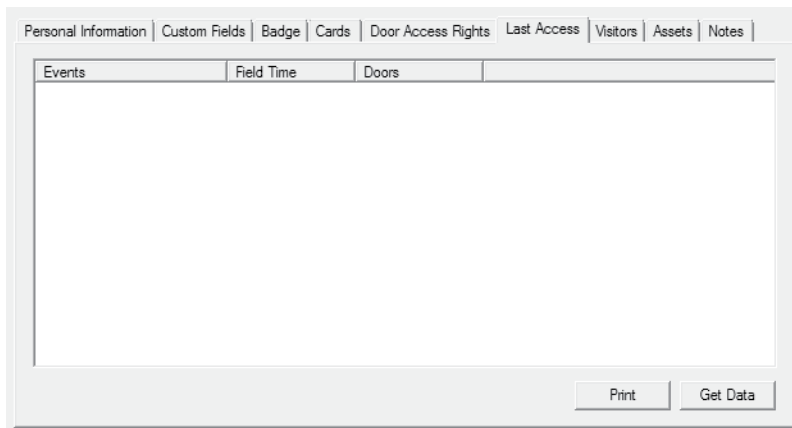

# CENTAUR

## Integrated Access Control V8.0

### Visitors

List the visitors, for which the user is responsible, that are still in the building. The **Visitor Name**, **Company**, **Arrival Time**, and **Schedule Departure Time** information are displayed.

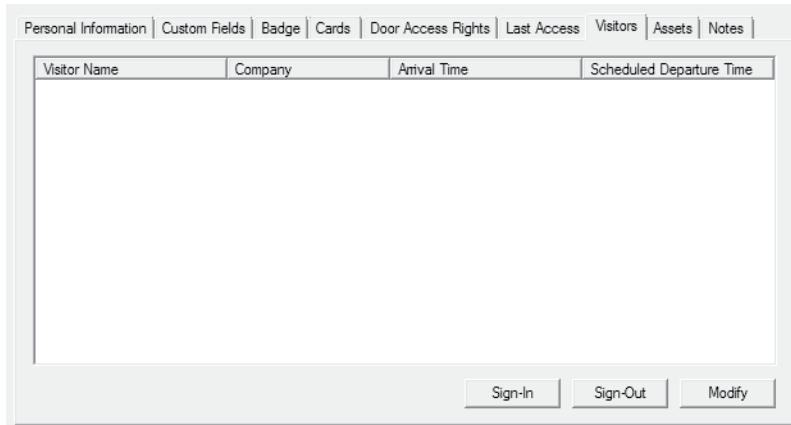

# CENTAUR

## Integrated Access Control V8.0

### Assets

List the assets assigned to the user. The Visitor Name, Category, Manufacturer, Model, and Serial Number information are displayed. Refer to “Assets” on page 208 for more information.

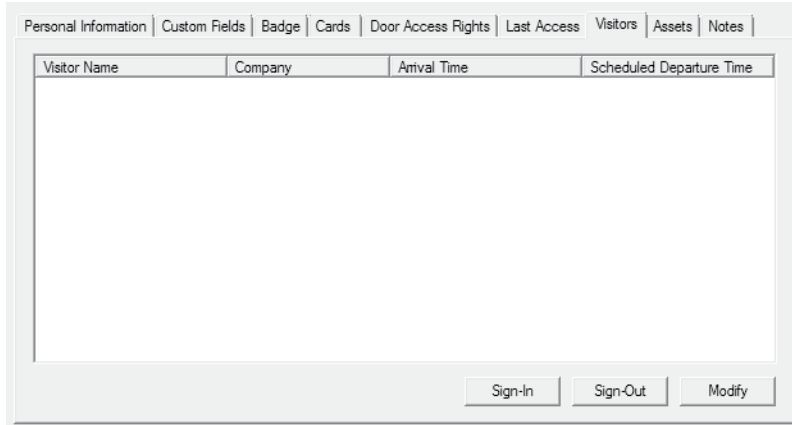

### Notes

Use the **Notes** tab text field to record any additional notes that may be required. We recommend that you keep a log of what settings were changed and when they were changed. Also, refer to “Typing Names and Notes” on page 30.



# CENTAUR

## Integrated Access Control V8.0

## DELETING A USER

In the Database Tree View window, right-click the desired user and click **Delete** from the drop-down list. You can also select the desired user and press the keyboard **Delete** key. A dialogue box will appear requesting confirmation. Also, refer to “FrontDesk” on page 75.

## ADDING A USER GROUP

In the Database Tree View window, right-click **Users** from the desired Site branch and click **New User Group**. The user group properties window will appear, allowing you to configure the user group properties. Refer to “Modifying a User Group” below for more information.

## MODIFYING A USER GROUP

From the desired Site branch in the Database Tree View window, right-click the user group you wish to modify and click **Properties** from the drop-down list. You can also select the desired user group and press the keyboard **Enter** key.

### General User Group Properties

From the user group properties window, select the **User Group** tab. This allows you to view some of the system’s component addresses as well as record the user group’s name and any additional notes.

#### Typing the User Group Name

Use the **Name** text field in the **User Group** tab to identify the user group. We recommend using a name that is representative of the user group such as **Production**. Also, refer to “Typing Names and Notes” on page 30

#### Selecting the User Group Schedule

Use the **Sch** text field in the **User Group** tab to record any additional notes that may be required. Also, refer to “Typing Names and Notes” on page <?>.

#### Typing the User Group Notes

Use the **Notes** text field in the **User Group** tab to record any additional notes that may be required. Also, refer to “Typing Names and Notes” on page <?>.

#### Typing the User Group Notes

Use the **Notes** text field in the **User Group** tab to record any additional notes that may be required. Also, refer to “Typing Names and Notes” on page <?>.

#### Typing the User Group Notes

Use the **Notes** text field in the **User Group** tab to record any additional notes that may be required. Also, refer to “Typing Names and Notes” on page 30.

The screenshot shows the 'User Group Properties' dialog box with the 'User Group' tab selected. The 'Name' field contains 'User Group 001', 'Schedule' is set to 'Always', and 'Type' is 'User'. There are also color selection options for text and background, and a 'Notes' text area at the bottom.

# CENTAUR

## Integrated Access Control V8.0

### Defining the Access Level for all Users of the User Group

The **Access Level 1** to **Access Level 4** drop-down lists identify which doors/schedules the user can access. Up to two access levels can be assigned to each user group by default, and up to four when the "Extended Access Levels (Levels 3/4)" check box is selected (refer to page 42). When you click one of the **Access Level** drop-down lists, all active access levels in the selected site will appear. Select the access level(s) you wish to assign to the user group. This will determine which doors in the site the users of this group will have access to and during which time periods each door can be accessed. For more information, refer to "Access Levels" on page 134. If two or more access levels are assigned to a user group, access is granted as long as one of the defined access levels is valid.

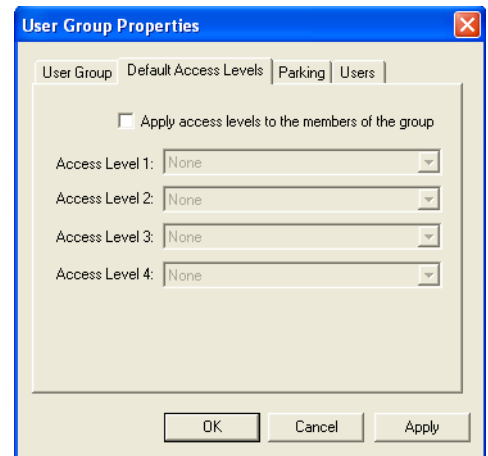

### Defining Parking Rules for the User Group

The parking options allow to enable the tracking of the number of cars present in the parking. The maximum parking capacity is configurable as well as the selection of the relay that will be activated when the capacity of the parking is reached.

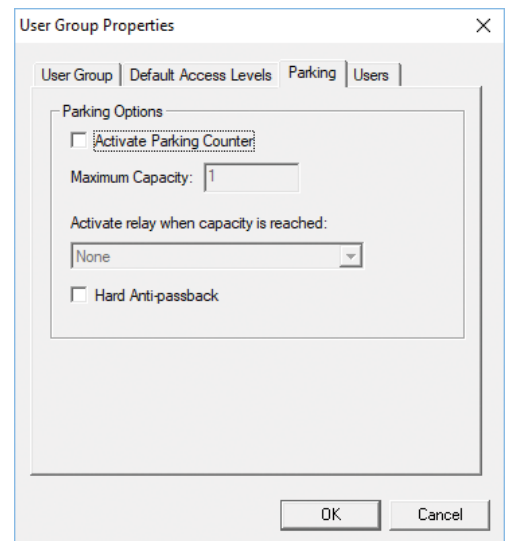

# CENTAUR

## Integrated Access Control V8.0

### Assigning Users to User Group

All users associated to the user group will be listed in the **Users** Tab.  
 To Add users to the group, click the **Add** button and all the users defined for this site will be listed at the exception of users already assigned to this group or to another group. Select all the users to be assigned to this group and click **OK** to confirm. To remove a user from the group, click on the desired user and click **Remove**.

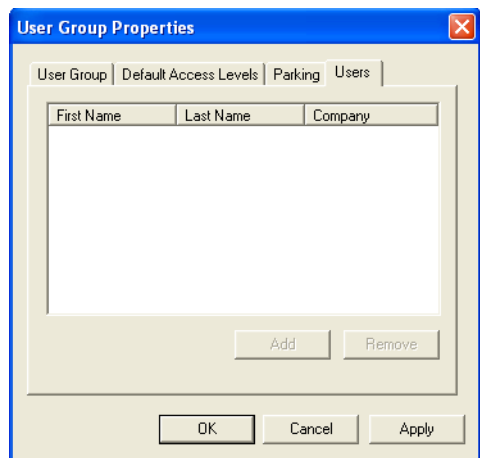

### DELETING A USER GROUP

In the Database Tree View window, right-click the desired user group and click **Delete** from the drop-down list. You can also select the desired user group and press the keyboard **Delete** key. A dialogue box will appear requesting confirmation.

# CENTAUR

## Integrated Access Control V8.0

## FRONTDESK

---

FrontDesk is a module that is automatically installed with the Centaur software. It provides an easy to use interface to program the user properties (see “General User Properties” on page 60) and includes an advanced search engine. You can run FrontDesk without having to run Centaur.

### Starting FrontDesk

FrontDesk can be started using one of two methods. To start FrontDesk from within Centaur, click the **Open FrontDesk** icon from the toolbar (refer to “Toolbar” on page 26), or click the **Modules** menu and click **FrontDesk**. You can also simultaneously press the **Ctrl** and **F1** keys. The **FrontDesk - User Management** window appears. In the tree view, select the site whose users you want to view or modify.

To start FrontDesk without Centaur running:

1. From Windows, click **Start, Programs, CDV Americas, Centaur, Administration Console**, and click **FrontDesk**.
2. From the Logon window, type the appropriate **Logon ID** and **Password**. FrontDesk uses the same logon IDs and passwords as Centaur. If you are logging on from a networked workstation, type the Centaur Server computer’s network name or IP address in the **Computer** text field. Select the desired language from the **Language** list.
3. The **FrontDesk - User Management** window appears. In the **Site** list, select the site whose users you want to view or modify.

# CENTAUR

## Integrated Access Control V8.0

### Using FrontDesk

After starting FrontDesk, all actions are performed using the icon toolbar at the top of the **FrontDesk** window. For more information on the settings available in these tabs, refer to “General User Properties” on page 60.

From the Database Tree View window of FrontDesk, select a site to access its users, user groups, and unassigned cards. The Database Tree View window of FrontDesk offers the same user/card management as the Database Tree View window of the Administration Console.

To modify a user or a user group, select it from the list and apply changes as required. See “Modifying a User” on page 60 for more information.

Users and Cards are sorted according to the site settings (refer to “Selecting the User Ordering criteria” on page 43).

### Buttons

#### *Add a New User*

To create a new user, click the **Add** button (+), program the user’s settings and click the **Save** button (💾).

#### *Delete the current user*

To delete the currently selected user, click the **Delete** button (-).

#### *Save the changes made to the current user*

To save any changes made to the currently selected user, click the **Save** button (💾).

#### *Cancel the changes made to the current user*

To undo any changes made to the currently selected user, click the **Cancel** button.

#### *Enroll a new card using the CMPP module*

To load or add a card using a CMPP card enrollment station, click the **CMPP** button.

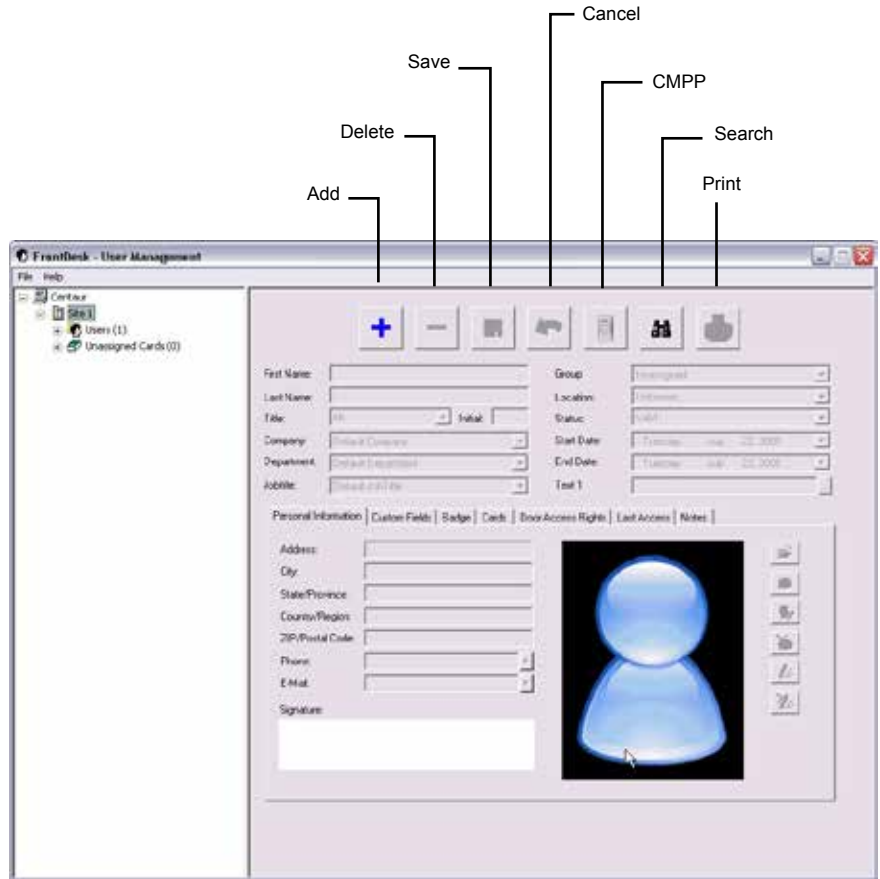

# CENTAUR

## Integrated Access Control V8.0

### *Search for a user, a card or an unassigned card*

To search for a user/card using specific criteria.

Click the **Search** button (binoculars).

The **Search** window appears.

From the drop-down lists or fields, select the desired criteria.

In the **Enter the text to search for below (Blank = ALL)** text field, type the text to search for. The text should be representative of the criteria selected in the **Field** drop list.

If you want the search to match exactly the selected criteria, select the **Exact match** check box.

Click the **Search** button.

From the **Results** list, highlight the desired user/card and click the desired action: **Print**, **Modify Card**, or **Modify User**.

### *Print the current user*

To print the card information on paper, click the **Print** button and click **OK** from the print window.

The screenshot shows a window titled "Search" with a close button (X) in the top right corner. The window contains the following elements:

- Site:** A dropdown menu currently showing "Site 1".
- Field:** A dropdown menu currently showing "First Name".
- Exact Match:** An unchecked checkbox labeled "Exact Match".
- Category:** A dropdown menu currently showing "Users".
- Search Text:** A text input field with the placeholder text "Enter the text to search for below (Blank = ALL)".
- Search:** A button labeled "Search".
- Results:** A table with the following columns: "First Name", "Last Name", and "Company". The table is currently empty.
- Buttons:** At the bottom of the window, there are four buttons: "Print", "Modify Card", "Modify User", and "Exit".

# CENTAUR

## Integrated Access Control V8.0



## Visitors and Visitor Groups

### What Will I Find?

---

Programming a visitor allows you to define the details pertaining to the visitor. Any individual that needs to access a door must be defined in the system as a visitor. Once defined, a card can be assigned to a visitor.

# CENTAUR

## Integrated Access Control V8.0

### ADDING VISITORS

In the Database Tree View window, right-click **Visitors** from the desired Site branch and click **New Visitor**. You can also select **Visitors** and press the keyboard **Insert** key. The visitor properties window will appear, allowing you to configure the visitor properties. Refer to “Modifying a Visitor” on page 80 for more information.

## MODIFYING A VISITOR

From the desired Site branch in the Database Tree View window, right-click the visitor you wish to modify and click **Properties** from the drop-down list. You can also select the desired visitor and press the keyboard **Enter** key.

### General Visitor Properties

#### First Name and Last Name

The **First Name** and **Last Name** are used to identify the visitor and will be used in the Visitors branch of the Database Tree View window for visitor identification.

#### Title

Allows the selection of the visitor title.

#### Initial

Allows to enter the visitor initials.

#### Company

Allows the selection of the visitor company group. Refer to "Groups" on page 184 for more information.

#### Host

Allows the selection of the user that will be responsible of the visitor.

#### Group

Allows the selection of the group the visitor belongs to. Refer to "Groups" on page 184 for more information.

#### Location

The **Location** field is used to indicate or change the global anti-passback status of a visitor: **In**, **Out** or **Unknown**. All visitor's location is set to **Unknown** after a reset of the anti-passback. Refer to "Controller Anti-passback Settings" on page 109 for more information.

#### Status

Indicates the status of the visitor: **Signed In** or **Signed Out**.

#### Scheduled Departure

Activates the departure time fields.

# CENTAUR

## Integrated Access Control V8.0

### Arrival Time and Departure Time

Use the **Arrival Time** and **Departure Time** drop-down lists to select the date and time the visitor arrives on site and the date and time the visitor expires. When the visitor time expires, the visitor's complete line under visitor status will become highlighted in red.

### Text 1

Use the **Text 1** field to display one of the custom fields (see "Custom Fields" on page 63) that you would like to see in the general section of the visitor properties window. Once selected, the field name **Text 1** will be replaced by the selected field name its content will appear at the right.

### Personal Information

From the **Visitor Properties** window, select the **Personal Information** tab and use these fields to record any personal information about the visitor.

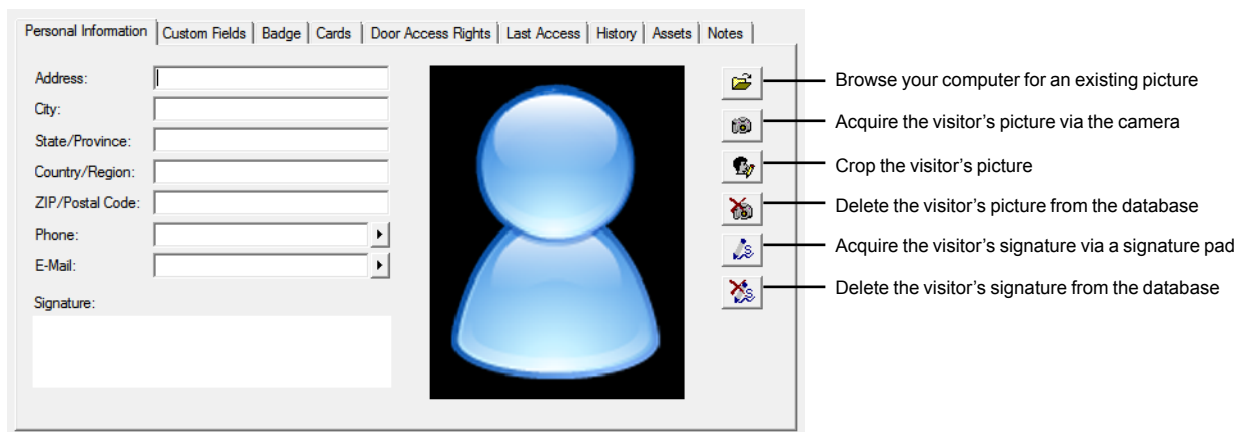

### Entering personal visitor's Information

Enter the visitor's **Address**, **City**, **State/Province**, **Country/Region**, **ZIP/Postal Code**, **Phone**, and **E-mail** information. Up to three **Phone** and **E-Mail** entries is available using the arrow at the right of the specific field.

### Assigning visitor's signature

You can associate a signature to a visitor which can be used for visual verification.

#### *Acquire signature via a signature pad*

Allow acquiring the visitor's signature using a signature pad. Click on this button to acquire the signature using a signature pad.

#### *Delete signature from the database*

Allows deleting the signature from the database. Click on this button to remove the signature from the database.

# CENTAUR

## Integrated Access Control V8.0

### Adding a Picture of the Visitor

You can associate a picture to a visitor, which is commonly used with Centaur’s visual authentication feature. When a visitor card is presented to a reader, Centaur’s visual authentication software can display the visitor’s picture. Use one of the following methods to associate a picture to the visitor.

*Browse your computer for an existing picture*

Allows selecting a picture on disk. Click on this button and select the photo file and click on **Open**.

*Acquire the visitor’s picture via the camera*

Allows acquiring a picture from a camera or a scanner. Click on this button and select either **Video (Direct Show)** or **Scan (Twain)**.

*Crop the visitor’s picture*

Allows cropping the picture proportionally. Click on this button and click-and-drag the appropriate corner to reduce the picture.

*Delete the visitor’s picture from the database*

Allows removing the visitor’s picture from the database. Click on this button to remove the visitor’s picture and replace it by the default picture.

### Custom Fields

From the **Visitor Properties** window, select the **Custom Fields** tab and use these fields to record any additional information about the visitor. For information on how to customize the titles of these fields, refer to “Custom Fields” on page 63.

The screenshot shows the 'Custom Fields' tab in a software interface. It features a grid of input fields:

- Text 1 through Text 12: Each is a text input field with a right-pointing arrow.
- Date 1 through Date 4: Each is a date selection dropdown menu, currently showing 'December-07-09'.
- Check 1 through Check 4: Each is an unchecked checkbox.

# CENTAUR

## Integrated Access Control V8.0

### Badge

The badge is used to define what will be printed directly on the front and back sides of the visitor access card.

1. From the visitor properties window, select the **Badge** tab.



2. Select a **Template** from the list or use the **Launch the badge template editor** button to create a new template (see “Launching the Centaur Badge Editor” below).
3. Select the language to be used from the **Language** drop list. The language selected will affect the fields included in the template.
4. Select the front or back side preview to be displayed using the **Front Side** or **Back Side** radio buttons.

### Buttons

*Launch the badge template editor*

Allows defining the front and back side of the badge. See “Launching the Centaur Badge Editor” below for more information.

*Print the selected badge*

Allows printing the defined visitor’s badge layout.

### Launching the Centaur Badge Editor



---

Refer to “Launching the Centaur Badge Editor” on page 65 for more information.

---

### Cards



---

Refer to “Cards” on page 140 for more information.

---

# CENTAUR

## Integrated Access Control V8.0

### Door Access Rights



---

Refer to “Door Access Rights” on page 69 for more information.

---

### Last Access



---

Refer to “Last Access” on page 69 for more information.

---

### History

List event’s history for the current visitors. The **Events Name**, **Host**, **Operator**, and **Time** information are displayed.

Event Name	Host	Operator	Time
------------	------	----------	------

View Details Refresh

### Assets



---

Refer to “Assets” on page 208 for more information.

---

### Notes



---

Refer to “Notes” on page 71 for more information.

---

# CENTAUR

## Integrated Access Control V8.0

### Deleting a Visitor

In the Database Tree View window, right-click the desired visitor and click **Delete** from the drop-down list. You can also select the desired visitor and press the keyboard **Delete** key. A dialogue box will appear requesting confirmation.

### ADDING A VISITOR GROUP

In the Database Tree View window, right-click **Visitors** from the desired Site branch and click **New Visitor Group**. The visitor group properties window will appear, allowing you to configure the visitor group properties. Refer to “Modifying a Visitor” below for more information.

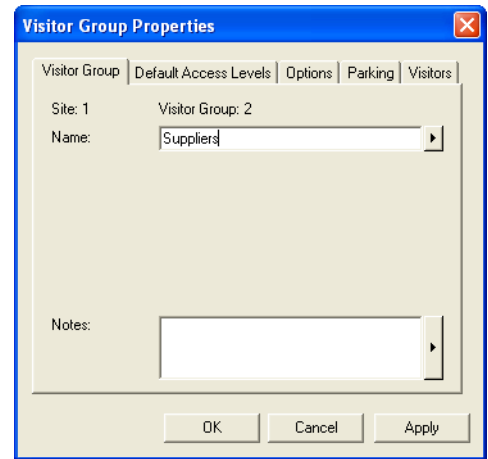

### MODIFYING A VISITOR GROUP

From the desired Site branch in the Database Tree View window, right-click the visitor group you wish to modify and click **Properties** from the drop-down list. You can also select the desired visitor group and press the keyboard **Enter** key.

#### General Visitor Group Properties

From the visitor group properties window, select the **Visitor Group** tab. This allows you to view the visitor group’s name and any additional notes.

##### Typing the Visitor Group Name

Use the **Name** text field in the **Visitor Group** tab to identify the visitor group. We recommend using a name that is representative of the visitor group such as **Suppliers**. Also, refer to “Typing Names and Notes” on page 30.

##### Typing the Visitor Group Notes

Use the **Notes** text field in the **Visitor Group** tab to record any additional notes that may be required. Also, refer to “Typing Names and Notes” on page 30..

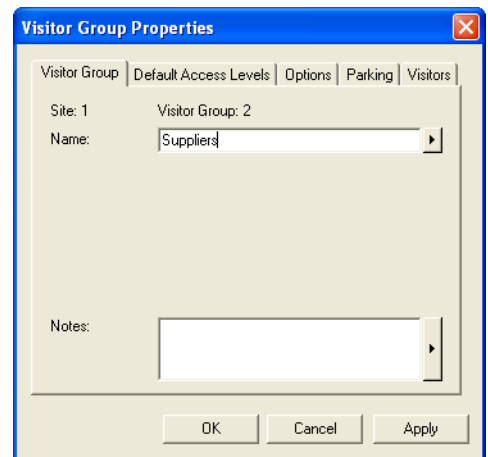

# CENTAUR

## Integrated Access Control V8.0

### Defining the Access Level for all Visitors of the Visitor Group

The **Access Level 1** to **Access Level 4** drop-down lists identify which doors/schedules the visitor can access. Up to two access levels can be assigned to each visitor group by default, and up to four when the “Extended Access Levels (Levels 3/4)” check box is selected (refer to page 42). When you click one of the **Access Level** drop-down lists, all active access levels in the selected site will appear. Select the access level(s) you wish to assign to the visitor group. This will determine which doors in the site the visitors of this group will have access to and during which time periods each door can be accessed. For more information, refer to “Access Levels” on page 134. If two or more access levels are assigned to a visitor group, access is granted as long as one of the defined access levels is valid.

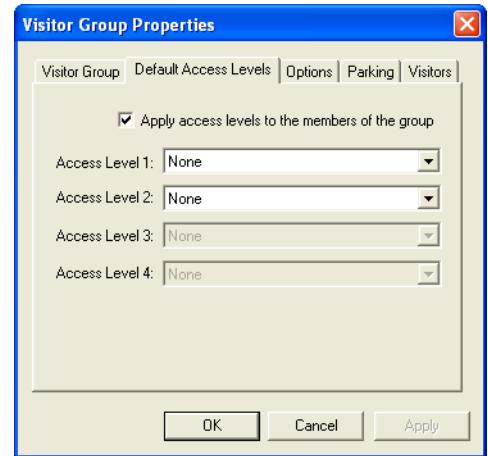

### Options

When the **Apply visitor options to the members of the group** check box is selected, the following parameters will apply to all users part of the visitor group.

#### Disable visitor’s card(s) upon departure

Visitor’s cards will be denied access upon departure. Visitor’s cards must be re-enabled to grant access upon the next sign-in. The card remains with the visitor when he leaves.

#### Unassign visitor’s card(s) upon departure

Visitor’s cards will become available to new visitors. A card must be assigned at next sign-in. The card is returned to the host or security guard.

#### Require signature upon departure

Visitors must electronically sign out when leaving (returning visitor card).

#### Default Host

Allows the selection of the user that will be assigned as the default host for all visitors that will be created.

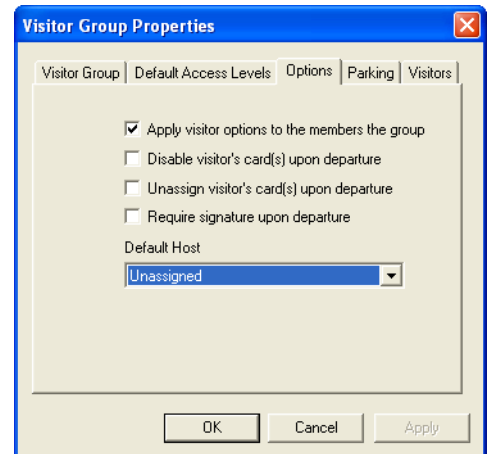

# CENTAUR

## Integrated Access Control V8.0

### Defining Parking Rules for the Visitor Group

The parking options allow to enable the tracking of the number of cars present in the parking. The maximum parking capacity is configurable as well as the selection of the relay that will be activated when the capacity of the parking is reached.

#### Activate Parking Counter

Allows to keep track of the number of cars present in the parking.

#### Maximum Capacity

Allows to limit the number of cars present in the parking.

#### Activate relay when capacity is reached

Allows the selection of the relay that will be activated when the capacity of the parking is reached.

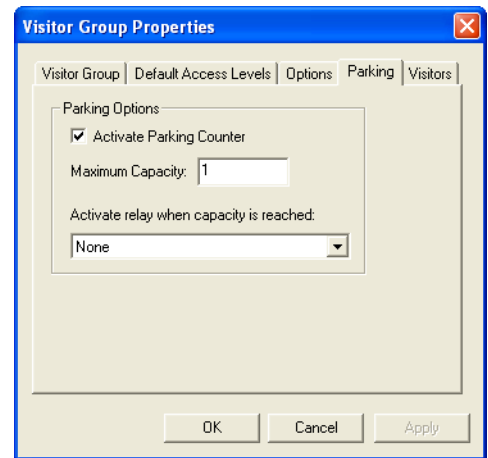

### Assigning Visitors to Visitor Group

All visitors associated to the visitor group will be listed in the **Visitors** Tab.

To Add visitors to the group, click the **Add** button and all the visitors defined for this site will be listed at the exception of visitors already assigned to this group or to another group. Select all the visitors to be assigned to this group and click **OK** to confirm. To remove a visitor from the group, click on the desired visitor and click **Remove**.

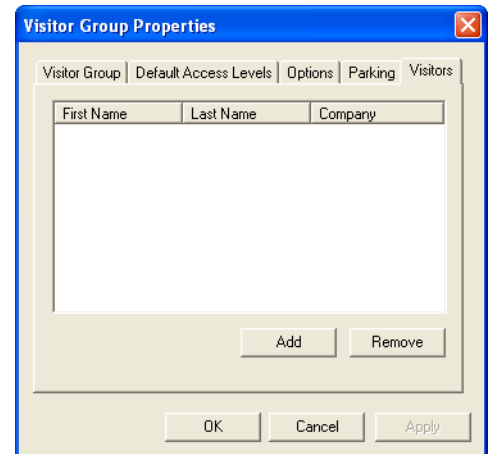

## DELETING A VISITOR GROUP

In the Database Tree View window, right-click the desired visitor group and click **Delete** from the drop-down list. You can also select the desired visitor group and press the keyboard **Delete** key. A dialogue box will appear requesting confirmation.

# CENTAUR

## Integrated Access Control V8.0



## Holidays

### What Will I Find?

---

You can define which days in a year are holidays and then the holidays can be assigned to a holiday group. If you assign the holiday to one or more holiday groups, schedules are valid or invalid depending on how the holiday group is assigned to a schedule's period (see "Schedule Periods" on page 94). If you do not assign a holiday to a holiday group, schedules are invalid (access denied) on that day.

# CENTAUR

## Integrated Access Control V8.0

### ADDING A HOLIDAY

Right-click **Holidays** in the desired **Site** branch and click **New Holiday**. You can also click **Holidays** and press the keyboard **Insert** key to add a new holiday. After adding a holiday, the **Holiday Properties** window will appear, allowing you to configure the holiday (see “Holiday Settings” below). Up to 128 holidays can be created in the system.

### MODIFYING A HOLIDAY

From the desired **Site** branch in the Database Tree View window, right-click on the holiday you wish to modify, and click **Properties**. You can also click the desired holiday and press the keyboard **Enter** key. The **Holiday Properties** window will appear, allowing you to configure the holiday.

#### General Holiday Properties

From the Holiday Properties window, select the **Holiday** tab. This allows you to view the holiday’s name and any additional notes.

##### Typing the Holiday Name

Use the **Name** text field in the **Holiday** tab to identify the holiday. We recommend using a name that is representative of the holiday such as **New Year’s Day**. Also, refer to “Typing Names and Notes” on page 30.

##### Typing the Holiday Notes

Use the **Notes** text field in the **Holiday** tab to record any additional notes that may be required. We recommend that you keep a log of which schedules have this holiday selected. Also, refer to “Typing Names and Notes” on page 30.

The screenshot shows the 'Holiday Properties' dialog box with the 'Holiday' tab selected. The 'Name' text box contains 'New Year's Day' and the 'Notes' text area is empty. The 'Site 1' dropdown is set to 'Holiday 1'. There are 'OK' and 'Cancel' buttons at the bottom right.

#### Holiday Settings

You can define which days in a year are holidays and then the holidays can be assigned to a holiday group. If you assign the holiday to one or more holiday groups, schedules are valid or invalid depending on how the holiday group is assigned to a schedule’s period (see “Schedule Periods” on page 94). If you do not assign a holiday to a holiday group, schedules are invalid (access denied) on that day.

Holiday group allows to group several holidays in one type.

The screenshot shows the 'Holiday Properties' dialog box with the 'Details' tab selected. The 'Day' dropdown is set to '1', 'Month' to 'January', and 'Year' to '2008'. Below these fields, there are four checkboxes for 'Holiday Group 1' through 'Holiday Group 4'. 'Holiday Group 1' is checked, while the others are unchecked. There are 'OK' and 'Cancel' buttons at the bottom right.



**Example:** Christmas, New Year’s Day, and Labour Day are all days where the site is closed and users are denied access all day. These can be grouped as **Holiday Group 1**. Half-days such as Christmas Eve, and New Year’s Eve would be grouped as **Holiday Group 2**. Religious days would be grouped as **Holiday Group 3**.

# CENTAUR

## Integrated Access Control V8.0

### Creating a Holiday and Assigning it to a Holiday Group

Perform the following to define the day, month, and year of the desired holiday.

1. From the **Holiday Properties** window, select the **Details** tab.
2. From the **Day** drop-down list, select a day from 1 to 31.
3. From the **Month** drop-down list, select a month from January to December.
4. From the **Year** drop-down list, select the desired year. If it is a holiday that occurs on the same month and day every year (e.g. New Year's Day), select the **Every Year** option from the drop-down list.
5. If required, assign the holiday to the desired holiday group(s) by selecting the appropriate check box(es).
6. Click **OK**.

## DELETING A HOLIDAY

---

To delete an existing holiday, right-click the holiday from the appropriate **Site** branch in the **Database Tree View window**, and click **Delete**. You can also select the desired holiday and press the keyboard **Delete** key. A dialogue box will appear requesting confirmation.

# CENTAUR

Integrated Access Control V8.0

# CENTAUR

## Integrated Access Control V8.0



## Schedules

### What Will I Find?

---

A schedule can be used to schedule tasks, automate operations and to control access to doors, elevator floors, and much more. Schedules play an important role in the operation of many Centaur functions and are widely used throughout the software. A schedule is made up of up to eight time periods which determine when that schedule will be valid. Each period in a schedule specifies the days and times the schedule will be valid. For example, when programming doors, a schedule can be assigned to a specific door and the schedule will dictate when the door can be accessed without the use of a card.

# CENTAUR

## Integrated Access Control V8.0

**Table 1: Where schedules can be used**

USED IN	AFFECTS	CROSS-REFERENCE
Site Programming	Communications Schedule	page 40
	Global Anti-Passback Reset Schedule	page 43
Access Level Programming	Card Programming	page 142
Controller Programming	Anti-Passback Schedule	page 109
	Anti-Passback Reset Schedule	page 109
Door Programming	Keypad Enabling Schedule	page 123
	Door Unlock Schedule	page 123
	REX Input Enabling Schedule	page 127
	Interlock Input Enabling Schedule	page 127
Relay Programming	Timed Activation Schedule	page 152
	Activating Schedule	page 153
Input Programming	Input Enabling Schedule	page 162
Event Programming	Event Display Schedule - General tab	page 177
	Save to Disk Schedule - General tab	page 177
	Device Activation Schedule - General tab	page 178
	Acknowledge Schedule - Alarms tab	page 179
	Sending E-mail Schedule - E-Mail tab	page 181
	Sending ASCII Command Schedule - CCTV Control tab	page 182
Elevator Control Programming	Floor Group Enabling Schedule	page 186
	Floor Schedules	page 186

Please note that Centaur includes two default schedules (**Always** and **Never**) which cannot be modified or deleted. The **Always** schedule is valid 24 hours a day, 365 days per year including any programmed Holidays. The **Never** schedule is invalid at all times.

## ADDING A SCHEDULE

In order to add a schedule, at least one site must be created. If you have not created a site, please refer to “Sites” on page 32.

To add a schedule, right-click **Schedules** in the desired Site and click **New Schedule** from the drop-down list. You can also click **Schedules** in the desired Site and press the keyboard **Insert** key. After adding a schedule, the **Schedule Properties** window will appear, allowing you to configure the schedule (see “General Schedule Properties” on page 94).

# CENTAUR

## Integrated Access Control V8.0

### MODIFYING A SCHEDULE

From the desired Site in the Database Tree View window, right-click the desired schedule from the **Schedules**, and click **Properties**. You can also click the desired schedule and press the keyboard **Enter** key. You cannot modify the default **Always** and **Never** schedules.

#### General Schedule Properties

From the **Schedule Properties** window, select the **Schedule** tab. This will allow you to view the schedule name and any additional notes.

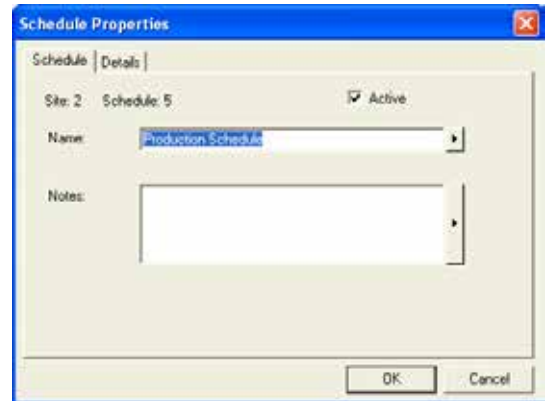

#### Active

Select the **Active** check box to enable the schedule, allowing you to assign the schedule as required. Clear the **Active** check box to disable the schedule without having to remove it from the database (this will disable any system device or card assigned to this schedule).

#### Schedule Name

Use the **Name** text field in the **Schedule** tab to identify the schedule. We recommend using a name that is representative of the schedule such as **Production Schedule**. Also, refer to “Typing Names and Notes” on page 30.

#### Schedule Notes

In the **Notes** text box, record any important explanations of the schedule and its use. Try to keep an up-to-date record of where the schedules are used. This will help you understand how disabling the schedule will affect the system. Also, refer to “Typing Names and Notes” on page 30.

#### Schedule Periods

Each schedule consists of up to eight periods and each period defines when the schedule will be valid. Each period can be programmed with a different start and end time. Use the check boxes to define which days of the week and which holiday groups will be used for each period. To define a schedule period:

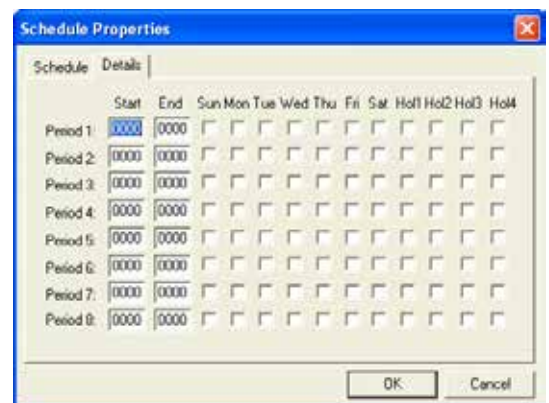

1. From the **Schedule Properties** window, select the **Details** tab.
2. In the desired period **Start** and **End** text fields, type the period start and end time using the 24Hr clock. For more information, refer to “Setting the Period Start and End Time” on page 95.
3. Select the check box(es) corresponding to the day(s) of the week you wish to assign to the schedule. The schedule will only be valid during the days of the week that have been selected and only at the times specified by the start and end times.
4. To assign the period to a holiday group, select the check box(es) corresponding to the desired holiday groups. For more information, refer to “Assigning Holiday Groups to a Schedule Period” on page 96.
5. Click **OK**.



**Example:** In “Figure 7”, the schedule will be valid from Monday to Friday between 7:00AM and 9:00PM and from Saturday to Sunday between 9:00AM and 1:00PM. The schedule will not be valid on any programmed holidays.

**CENTAUR**  
Integrated Access Control V8.0

Figure 1: Schedule example

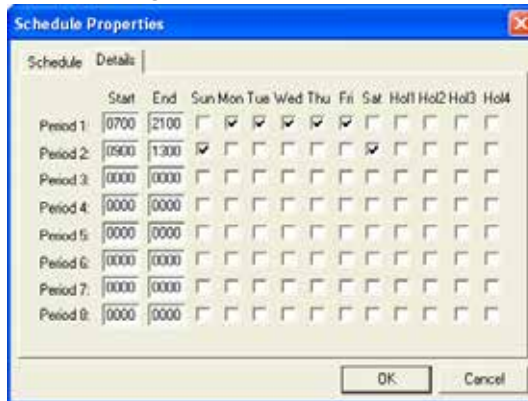

**Setting the Period Start and End Time**

When defining the schedule period (see “Schedule Periods” on page 81), the **Start** and **End** text fields define when the schedule is valid. The start and end times apply only to the selected days of the week. Note that you must use the 24Hr clock to program the times (i.e. 6:00PM = 1800). If you want the period to be valid 24 hours a day, type 0000 into the **Start** text field and 2400 into the **End** text field.



**The start and end time of a single period cannot cross over into another day. You must use separate periods. For example, 23h (11 PM) Sunday night to 7h AM Friday morning must be programmed as follows: Period 1 = Sunday 2300 to 2400 Period 2 = Friday 0000 to 0700.**

Figure 2: Programming Crossover Periods

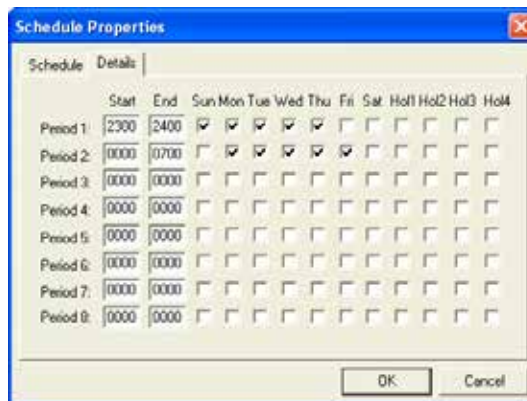

# CENTAUR

## Integrated Access Control V8.0

### Assigning Holiday Groups to a Schedule Period

When defining the schedule's periods (see "Schedule Periods" on page 92), select the **Hol1**, **Hol2**, **Hol3**, and **Hol4** check boxes to assign any of the site holiday groups to one or more periods within the schedule. For more information on holidays, refer to "Creating a Holiday and Assigning it to a Holiday Group" on page 90. Holiday groups function as follows:

- When you clear a holiday group check box, the schedule's period is **invalid** during holidays assigned to that holiday group.
- When you select a holiday group check box, the schedule's period is **valid** between its start and end time on any holidays assigned to that holiday group, even if the holiday falls on a day that is not enabled in the schedule's period.
- To create a different start and end time period for holidays only (a holiday schedule), assign the holiday group to a separate (new) period. Set the start and end time, but do not select any of the "day" check boxes (Sun to Sat).

## DELETING A SCHEDULE

---

To delete an existing schedule, right-click the schedule from the **Schedules** and click **Delete**. You can also click the desired schedule from the **Schedules** and press the keyboard **Delete** key. A dialogue box will appear requesting confirmation. You cannot delete the default **Always** and **Never** schedules. You cannot delete a schedule assigned/used in other parts of the system such as access levels, door schedules, etc.

# CENTAUR

Integrated Access Control V8.0

# CENTAUR

## Integrated Access Control V8.0



## Controllers

### What Will I Find?

---

Controllers are the heart of the Centaur integrated access control system. The database is distributed to all controllers allowing them to make decisions in a fraction of a second, whether or not the managing computer is online. These controllers also feature online upgradable firmware and a real-time clock.

Program each controller individually by defining its door input and output configuration as well as setting its anti-passback options. For additional communication settings, refer to "Sites" on page 32. Each site can support up to 256 controllers.

# CENTAUR

## Integrated Access Control V8.0

### ADDING CONTROLLERS

Perform the following to add one controller or multiple controllers at one time:

1. From the Database Tree View window, right-click **Controllers** from the desired Site and select **New Controllers** from the drop-down list. You can also click **Controllers** and press the keyboard **Insert** key.
2. A dialogue box appears providing you with the option to automatically create and link the default doors, inputs and outputs to the new controller(s). To use the Controller Configuration Wizard, click **Yes** and follow the steps detailed in "Controller Configuration Wizard" below. Otherwise, click **No** and continue with step 3.
3. Select the desired controller address(es) and click **OK**. For more information on controller addresses, refer to "Viewing the Controller Address" on page 88. After adding the controller(s), you will have to program each controller individually within the Controller Properties window (see "Modifying a Controller" on page 104).



### Controller Configuration Wizard

The Controller Configuration Wizard guides you through the minimum required settings to set up the default doors, inputs and outputs for the controller(s).

1. Check the **Create** check box for each controller you want to create.
2. To change the controller's name, double click on the name of the controller and type the new name.
3. To automatically activate the controller once created, select its **Active** check box.

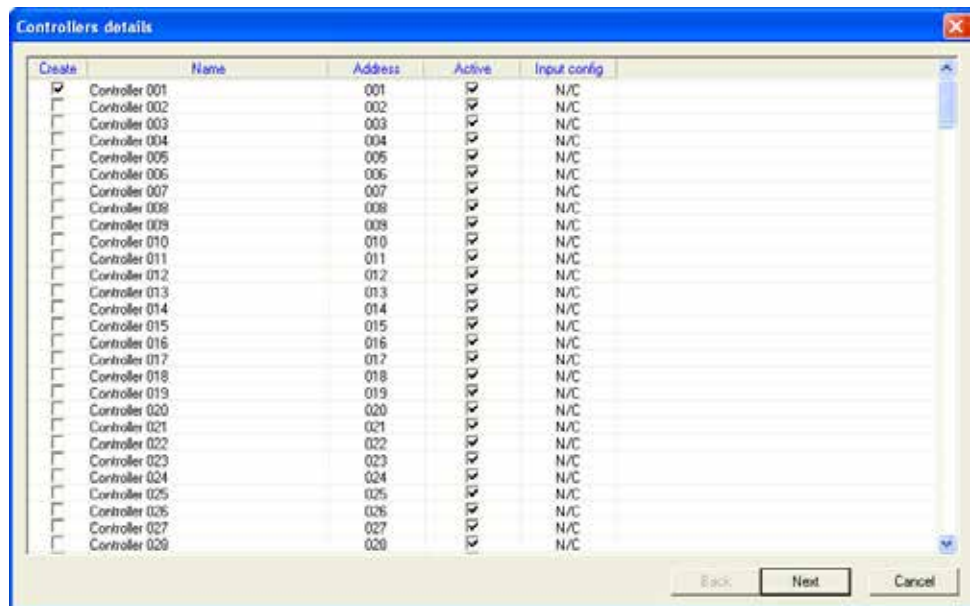

4. Select the controller input configuration. See "Controller Configuration" on page 103 for more information.
5. Click **Next**.

# CENTAUR

## Integrated Access Control V8.0

6. Under the **Create** label, select the check box next to each door address you would like to add for each controller.
7. To change the door's name, double click on the name of the door and type the new name.
8. From the **Contact** drop-down list, select the contact's zone input address. If there is no contact associated with the door, select **None**.
9. From the **REX** drop-down list, select the REX's zone input address. If there is no REX associated with the door, select **None**.
10. From the **Green LED** drop-down list, select the green LED's PGM output address. If there is no green LED associated with the door, select **None**.
11. From the **Red LED** drop-down list, select the red LED's PGM output address. If there is no red LED associated with the door, select **None**.
12. From the **Buzzer** drop-down list, select the buzzer's PGM output address. If there is no buzzer associated with the door, select **None**.
13. Click **Finish**.

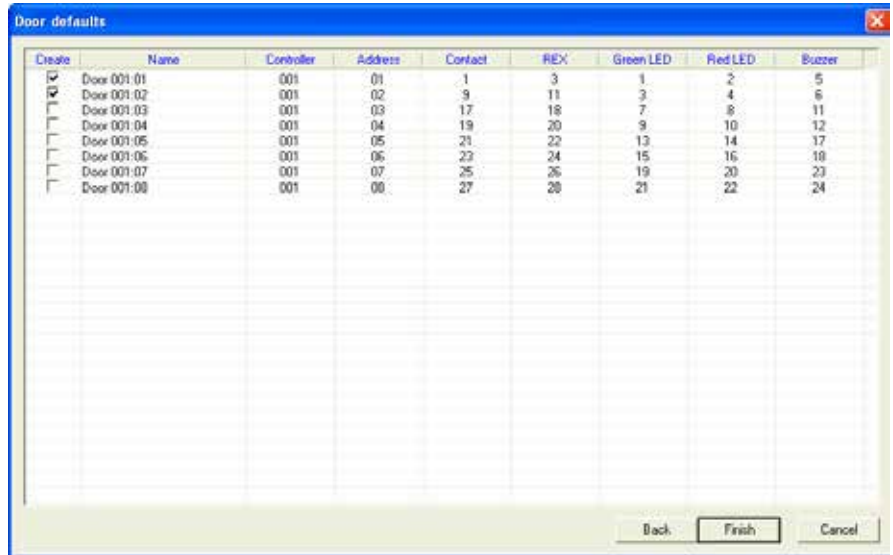

# CENTAUR

## Integrated Access Control V8.0

## MODIFYING A CONTROLLER

To modify an existing controller, right-click the desired controller from the **Controllers** and click **Properties** from the drop-down list. You can also click the desired controller and press the keyboard **Enter** key. The **Controller Properties** window will appear, allowing you to configure the controller.

### General Controller Properties

From the **Controller Properties** window, select the **Controller** tab to view the controller's address as well as record the controller's name and any additional notes.

#### Viewing the Controller Address

At the top of the **Controller** tab, Centaur will display the site's address as well as the controller's address. Each controller in a site is assigned to an address by setting the dip switches located on the controller (see "Table on page 102). Also, refer to "Figure on page 103.



***The controller addresses are greatly affected by the controller's COM port assignment. Please refer to "Assigning COM Ports to Controller Addresses" on page 33 for more information.***

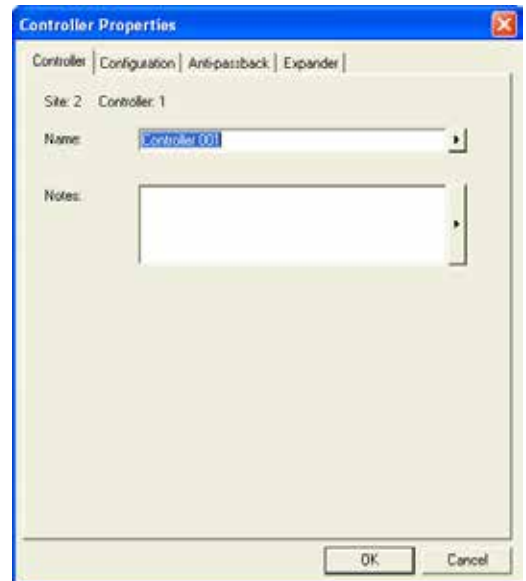

**CENTAUR**  
Integrated Access Control V8.0

Table 1: Assigning Controller Addresses Via Dip Switches

Cont. Add.	Controller Dip Switches						Cont. Add.	Controller Dip Switches					
	1	2	4	8	16	32		1	2	4	8	16	32
1	OFF	OFF	OFF	OFF	OFF	OFF	33	OFF	OFF	OFF	OFF	OFF	ON
2	ON	OFF	OFF	OFF	OFF	OFF	34	ON	OFF	OFF	OFF	OFF	ON
3	OFF	ON	OFF	OFF	OFF	OFF	35	OFF	ON	OFF	OFF	OFF	ON
4	ON	ON	OFF	OFF	OFF	OFF	36	ON	ON	OFF	OFF	OFF	ON
5	OFF	OFF	ON	OFF	OFF	OFF	37	OFF	OFF	ON	OFF	OFF	ON
6	ON	OFF	ON	OFF	OFF	OFF	38	ON	OFF	ON	OFF	OFF	ON
7	OFF	ON	ON	OFF	OFF	OFF	39	OFF	ON	ON	OFF	OFF	ON
8	ON	ON	ON	OFF	OFF	OFF	40	ON	ON	ON	OFF	OFF	ON
9	OFF	OFF	OFF	ON	OFF	OFF	41	OFF	OFF	OFF	ON	OFF	ON
10	ON	OFF	OFF	ON	OFF	OFF	42	ON	OFF	OFF	ON	OFF	ON
11	OFF	ON	OFF	ON	OFF	OFF	43	OFF	ON	OFF	ON	OFF	ON
12	ON	ON	OFF	ON	OFF	OFF	44	ON	ON	OFF	ON	OFF	ON
13	OFF	OFF	ON	ON	OFF	OFF	45	OFF	OFF	ON	ON	OFF	ON
14	ON	OFF	ON	ON	OFF	OFF	46	ON	OFF	ON	ON	OFF	ON
15	OFF	ON	ON	ON	OFF	OFF	47	OFF	ON	ON	ON	OFF	ON
16	ON	ON	ON	ON	OFF	OFF	48	ON	ON	ON	ON	OFF	ON
17	OFF	OFF	OFF	OFF	ON	OFF	49	OFF	OFF	OFF	OFF	ON	ON
18	ON	OFF	OFF	OFF	ON	OFF	50	ON	OFF	OFF	OFF	ON	ON
19	OFF	ON	OFF	OFF	ON	OFF	51	OFF	ON	OFF	OFF	ON	ON
20	ON	ON	OFF	OFF	ON	OFF	52	ON	ON	OFF	OFF	ON	ON
21	OFF	OFF	ON	OFF	ON	OFF	53	OFF	OFF	ON	OFF	ON	ON
22	ON	OFF	ON	OFF	ON	OFF	54	ON	OFF	ON	OFF	ON	ON
23	OFF	ON	ON	OFF	ON	OFF	55	OFF	ON	ON	OFF	ON	ON
24	ON	ON	ON	OFF	ON	OFF	56	ON	ON	ON	OFF	ON	ON
25	OFF	OFF	OFF	ON	ON	OFF	57	OFF	OFF	OFF	ON	ON	ON
26	ON	OFF	OFF	ON	ON	OFF	58	ON	OFF	OFF	ON	ON	ON
27	OFF	ON	OFF	ON	ON	OFF	59	OFF	ON	OFF	ON	ON	ON
28	ON	ON	OFF	ON	ON	OFF	60	ON	ON	OFF	ON	ON	ON
29	OFF	OFF	ON	ON	ON	OFF	61	OFF	OFF	ON	ON	ON	ON
30	ON	OFF	ON	ON	ON	OFF	62	ON	OFF	ON	ON	ON	ON
31	OFF	ON	ON	ON	ON	OFF	63	OFF	ON	ON	ON	ON	ON
32	ON	ON	ON	ON	ON	OFF	64	ON	ON	ON	ON	ON	ON

# CENTAUR

## Integrated Access Control V8.0

: Overview of Controller Programming

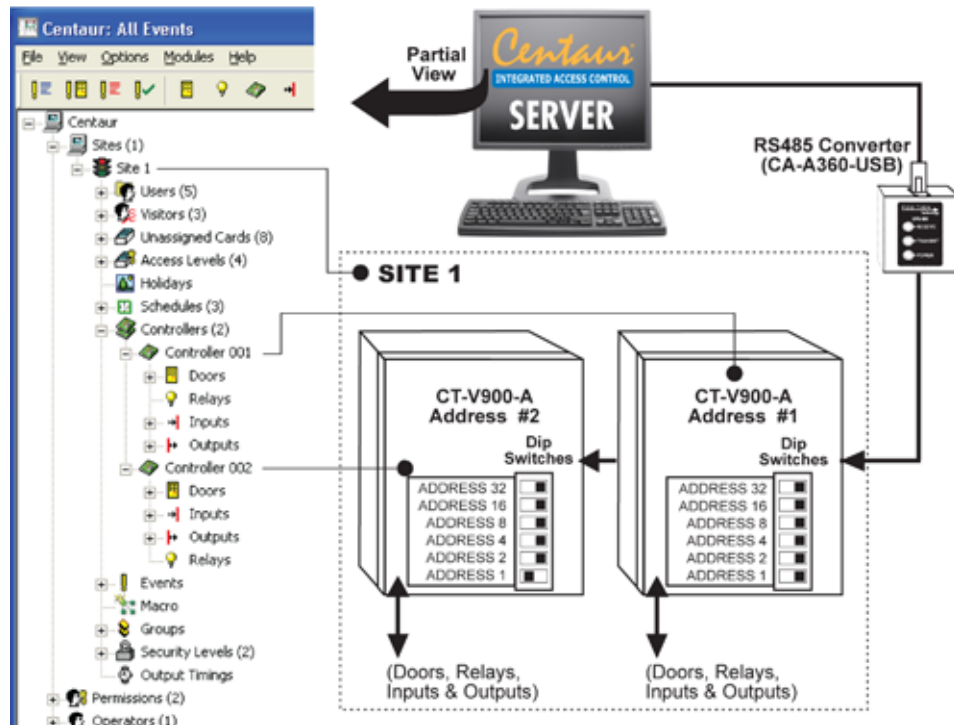

### Typing the Controller Name

Use the **Name** text field in the **Controller** tab to identify the controller's use or location. We recommend using name that is representative of the controller such as **Main Entrance**. Also, refer to "Typing Names and Notes" on page 30.

### Typing the Controller Notes

Use the **Notes** text field in the **Controller** tab to record any additional notes that may be required. We recommend that you keep a log of when and what settings were changed. Also, refer to "Typing Names and Notes" on page 30.

# CENTAUR

## Integrated Access Control V8.0

### Controller Configuration

From the **Controller Properties** window, select the **Configuration** tab. The **Configuration** tab will allow you to program some of the communication settings as well as select the door and input configurations that will be used with the selected controller.



For more information on how to set up doors located on the 2-Door Expansion Modules, please refer to “Door Expansion Module Configuration” on page 110.

### Selecting the Door Reader and Keypad Configuration

From the **Controller Properties** window, select the **Configuration** tab. Notice that when you click the **Configuration** tab, a **Reader** and a **Keypad** drop-down list appears for each door. Use these fields to configure the controller to function with the readers and/or keypads connected to the controller. In the **Configuration** tab, the doors will be labeled **Door 1** and **Door 2**. These are directly linked to where on the controller the readers and/or keypads are connected as shown in “Figure on page 105

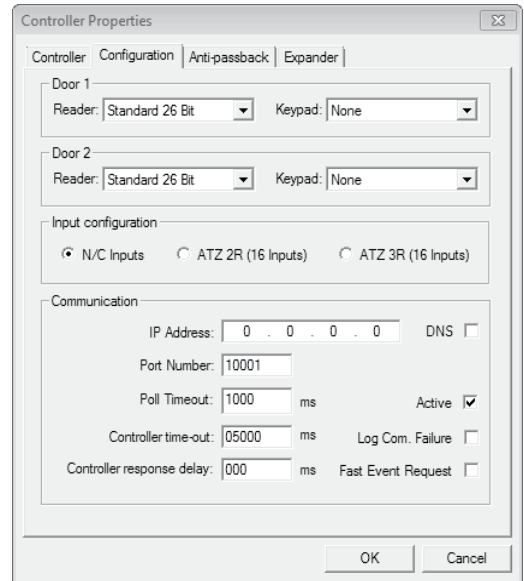

# CENTAUR

## Integrated Access Control V8.0

: Controller's Door Configuration

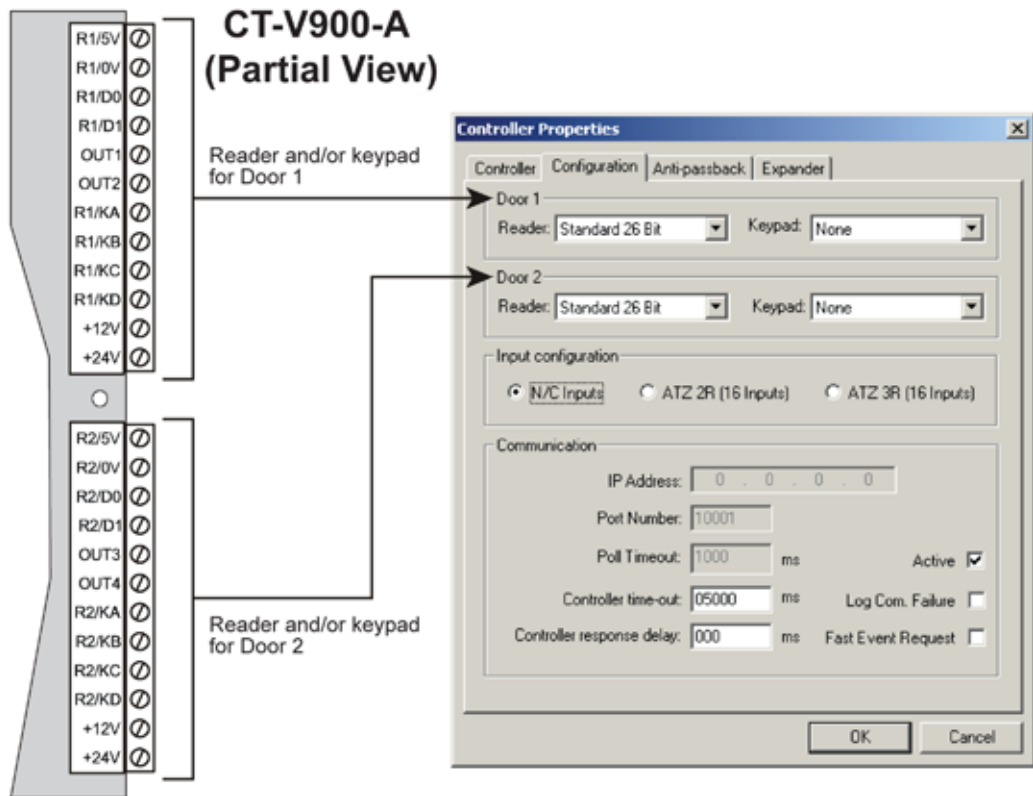

### Reader Type

From the **Reader** drop-down list, select the protocol of reader used. If no reader is being used on the selected door, select **None**.

### Keypad Type

From the **Keypad** drop-down list, select the protocol of keypad used. If the controller's door is not using a keypad, select **None**. When both a reader and a keypad are used, only users with the **Use Keypad** option enabled (see "Use Keypad" on page 143) have to use both to gain access.

# CENTAUR

## Integrated Access Control V8.0

### Setting the Controller Input Configuration

Each controller has eight inputs that can be doubled to 16 and each 2-Door Expansion Module (CA-A470-A) has four inputs. This means that the controller can monitor the state of up to 28 input devices. These inputs can be used to monitor devices such as magnetic contacts, motion detectors, and temperature sensors. Under **Input Configuration**, select one of the three following input configuration radio buttons. The selected input configuration applies to the controller's inputs and the inputs located on the controller's 2-Door Expansion Modules.

#### *NC Inputs*

This setup will not support tamper and wire fault (short circuit) recognition, but will generate an alarm condition when the state of the input is breached. All inputs on the selected controller and its 2-Door Expansion Modules must be connected using the NC Input Connection Method described in "NC Input Connection" on page 157.

#### *ATZ 2R (16 Inputs)*

This setup will not support wire fault (short circuit) recognition, but will generate an alarm condition when the state of the input is breached. This method also requires the connection of two devices to each controller's input for a total of 16 inputs. The 2-Door Expansion Modules do not support input doubling. All inputs on the selected controller and its 2-Door Expansion Modules must be connected using the ATZ 2R Input Connection Methods described in "ATZ 2R Connection" on page 158.

#### *ATZ 3R (16 Inputs)*

This setup generates an alarm condition when the state of the input is breached. An alarm condition is also generated when a wire fault (short circuit) occurs. This method requires the connection of two devices to each controller's input for a total of 16 inputs. The 2-Door Expansion Modules do not support input doubling. All inputs on the selected controller and its 2-Door Expansion Modules must be connected as described in "ATZ 3R Connection Method" on page 159.

### Configuring the Controller Communication Settings

Under **Communication**, configure the controller's communication settings.

#### *IP Address, DNS, and Port Number*

The **IP Address**, **DNS**, and **Port Number** text fields are available only if the selected communication type is **TCP/IP (LAN/WAN)** as described in "Selecting the Site Communication Type" on page 36. Before entering this data, you need a "static" IP address or DNS name, and port number for each CA-ETHR-A, which should be provided by your Network Administrator. You will then need to program each CA-ETHR-A with an IP address or DNS name, and a port number. In the **IP Address** or **DNS** name and **Port Number** text fields, type the IP address or DNS name, and port number programmed into the CA-ETHR-A device that is connected to the controller. If there are several controllers wired to one CA-ETHR-A device, then each controller on that loop must be programmed with the same IP address or DNS name as detailed in the example below.

The first time you program a CA-ETHR-A, it will be done via a serial port using DB9 to RJ-11 cable included with the CA-ETHR-A. To initiate a communication with the CA-ETHR-A, press the reset button and type **postech** within 5 seconds, if you pass this delay you won't be able to log in. Once programmed, you will be able to access the configurations easily by using a web browser and simply typing in the IP address or DNS name. To program the Port #, the range is from 1 - 65535, however do not use 21, 25, 80, or 110 as they are reserved. For further details please consult the CA-ETHR-A Installation Guide.

# CENTAUR

## Integrated Access Control V8.0



**Example:** In "Figure 11", the IP Address for controller #1 and #2 would be 10.10.10.2 and the IP Address for controller #3 and #4 would be 10.10.10.3. The port number for controller #1 and #2 would be 10001 and the port number for controller #3 and #4 would be 10001.

: Example of TCP/IP Controller Settings

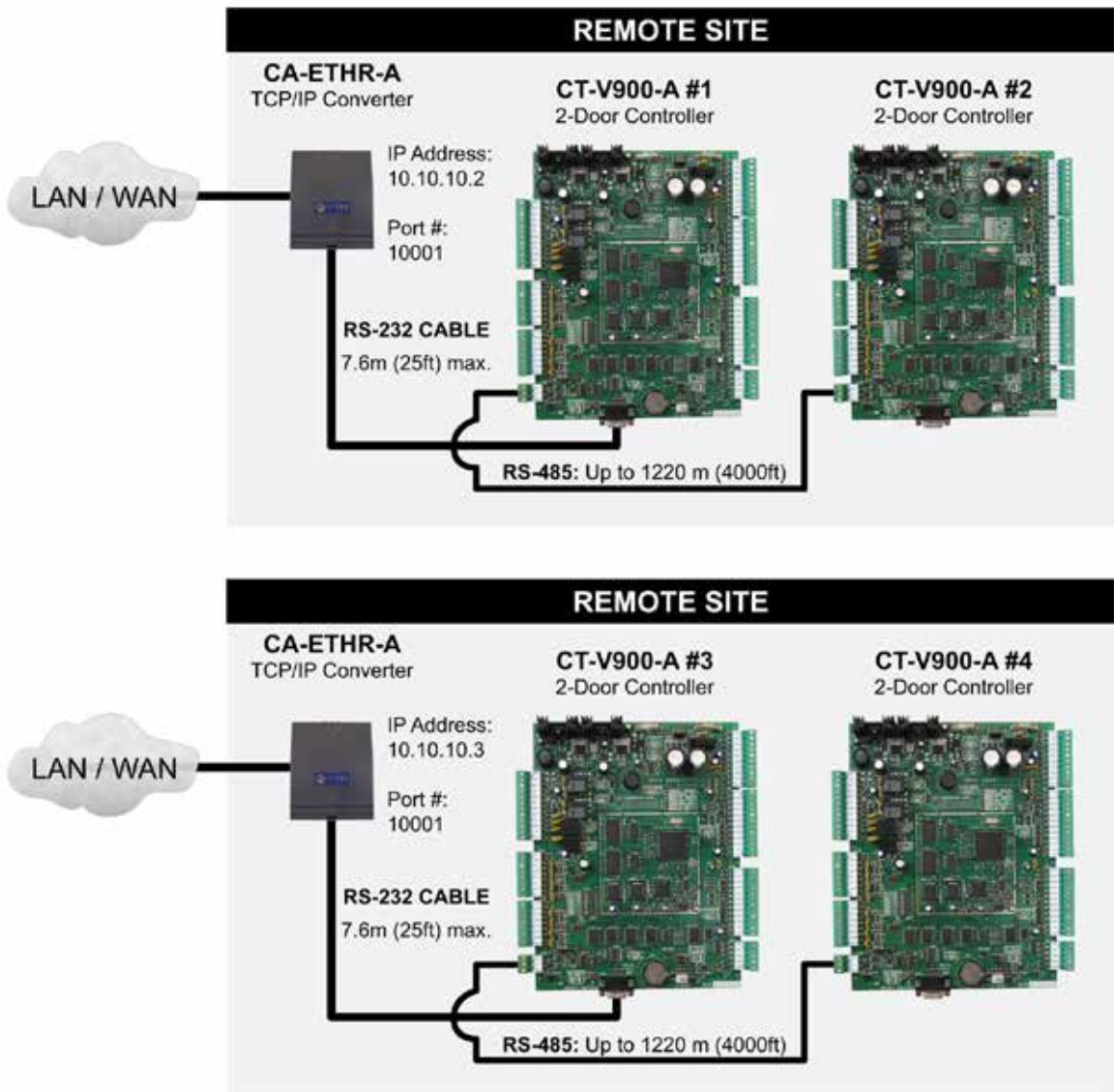

# CENTAUR

## Integrated Access Control V8.0

### *Poll Timeout*

The **Poll Timeout** text field appears only if the selected communication type is **TCP/IP (LAN/WAN)** as described in "Selecting the Site Communication Type" on page 36. Depending on network traffic, you may need to increase this value to improve communication speed between the Centaur Server and the controllers. In the **Poll Timeout** text field, type a value between 500 and 5000 milliseconds.

### *Active*

When the **Active** check box is selected, communication between the Centaur Server and the controller is possible. Clear the **Active** check box to cancel any communication between the controller and the Centaur Server.

### *Controller Timeout*

Enter the length of time the controller will wait for a response from the Centaur Server before generating a Communication Failure locally at the controller.

### *Log Com. Failure*

When the **Log Com. Failure** check box is selected, Communication Failures between the controller and the Centaur Server are logged.

### *Controller Response Delay*

In the **Controller response delay** text field, type the amount of time (1 to 255 milliseconds) that the controller will wait before responding to a command from the Centaur Server.

### *Fast Event Request*

When the **Fast Event Request** check box is selected, the event upload rate is increased in order to prevent lost of events.

# CENTAUR

## Integrated Access Control V8.0

### Controller Anti-passback Settings

You can use local anti-passback to closely monitor the movements of the users and prevent any tailgating. Tailgating occurs when a user does not use a card at the reader and enters through the door opened by another user who has already used their card. To use this feature, the controller must have its doors configured as **Entry** and **Exit** doors. For more information, refer to “Doors” on page 127.

When a card is presented to an **Entry** reader, the controller labels the card as **in**. The next time the card is used, it must be presented to an **Exit** reader, in which case it will be labeled as **out**. Please note that the user must exit from an **Exit** door associated to the same controller. Two subsequent **Entries** or two subsequent **Exits** will cause the controller to generate the appropriate **Access Denied - Anti-passback violation** event.

Centaur also supports **Global Anti-Passback**, which functions independently of the local anti-passback settings defined in the following sections. For more information, refer to “Global Entry or Global Exit” on page 121.

#### Enabling Controller Anti-passback

Select the **Anti-passback** tab and select the **Anti-passback** check box to activate the anti-passback feature.

#### Selecting the Anti-Passback Schedule

From the **Schedule** drop-down list, select the schedule during which the anti-passback status of cards will be monitored. Note that the **Anti-passback** check box must be selected. For more information on schedules, refer to “Schedules” on page 92.

#### Enabling Hard-passback

Select the **Hard-passback** check box to deny access to the door when the “Access Denied - Anti-passback violation” event occurs. Clear this check box to grant access to the door when the **Access Denied - Anti-passback violation** event occurs. Please note that to enable hard-passback you must also enable the **Anti-Passback**.

#### Selecting the Anti-passback Reset Schedule

From the **Reset Schedule** drop-down list, select the schedule that will reset the anti-passback status of all cards to **unknown**. This reset will occur at the start of every period in the selected schedule. For more information on schedules, refer to “Schedules” on page 92..

#### Selecting the Anti-passback Reset Input

Select the **Reset on Input** check box, and select an input from the **Input** drop-down list. Clear the check box to deactivate this feature.

#### Selecting the Anti-passback Activation Relay

From the **Activate Relay When Area is Empty** drop-down list, select the relay that will activate whenever there are no longer any cards in the controller labelled as **in**. For example, you can use the relay to arm a security system when everyone is out of the building.

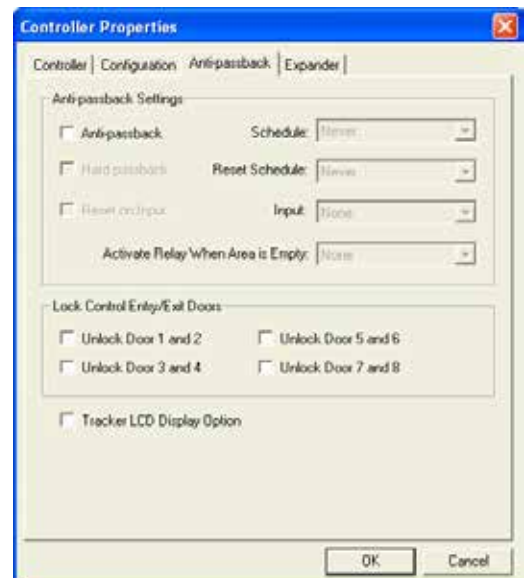

# CENTAUR

## Integrated Access Control V8.0

### Setting Lock Control for Entry/Exit Doors

When doors are set up for **Entry** and **Exit** (see “Door Type” on page 120), the controller can be programmed to unlock both doors upon valid access. Under the **Lock Control Entry/Exit Doors** heading, select one or more of the following check boxes: **Unlock Door 1 and 2**, **Unlock Door 3 and 4**, **Unlock Door 5 and 6**, and **Unlock Door 7 and 8**. This feature is typically used when an entry and exit reader are set up on the same door and the door is using both a magnetic lock and an electromagnetic lock.

### Enabling the Tracker LCD Display Option

Each Tracker LCD is assigned to a specific door. When this feature is disabled, the Tracker LCD keypad will only display messages that occur on the assigned door. Select the **Tracker LCD Display Option**. When selected, Tracker LCD keypad can be used to display the messages for both doors on the controller or 2-Door Expansion Module. For example, a Tracker LCD keypad assigned to door 1 will display messages occurring on doors 1 and 2.

### Door Expansion Module Configuration

Select the **Expander** tab to program door and keypad configurations that will be used with the selected controller’s 2-Door Expansion Modules (CA-A470-A). A maximum of three 2-Door Expansion Modules can be used with each controller.

#### Door Expander’s Configuration

Notice that when you click the **Expander** tab, two **Reader** and two **Keypad** drop-down lists appear for each 2-Door Expansion Module. Use these fields to configure the readers and/or keypads connected to the 2-Door Expansion Modules. In the **Expander** tab, each **Reader** and **Keypad** drop-down list is associated with a predetermined input on a specific 2-Door Expansion Module, which is determined by its DIP switch settings as shown in on page 111.

##### Reader

From the **Reader** drop-down list, select the type of reader used. If no reader is being used on the selected door input, select **None**.

##### Keypad

From the **Keypad** drop-down list, select the type of keypad used. If the door is not using a keypad, select **None**. When both a reader and a keypad are used, only users with the **Use Keypad** option enabled (see “Use Keypad” on page 130) have to use both to gain access.

##### Poll Door Expander Status Non-Stop

By enabling the **Poll Door Expander Status Non-Stop (Front View)** check box, Centaur will poll the selected 2-Door Expansion Module every time it polls the controller. Select this feature when using Centaur’s **FrontView**. If it is not selected, Centaur’s **FrontView** might display the 2-Door Expansion module as offline. If you are not using Centaur’s **FrontView**, clear this feature check box.

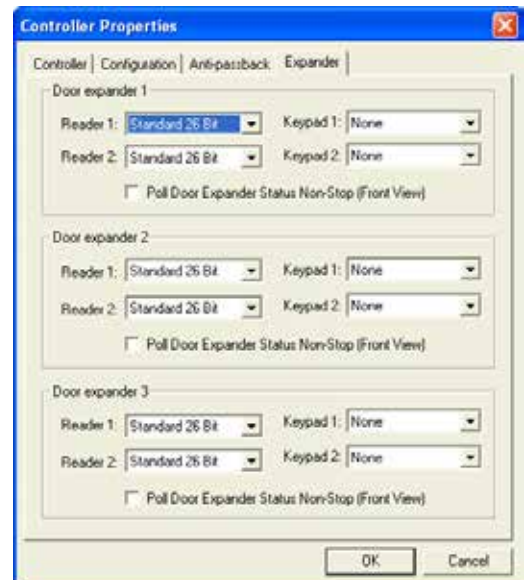

# CENTAUR

## Integrated Access Control V8.0

2-Door Expansion Module's Door Configuration

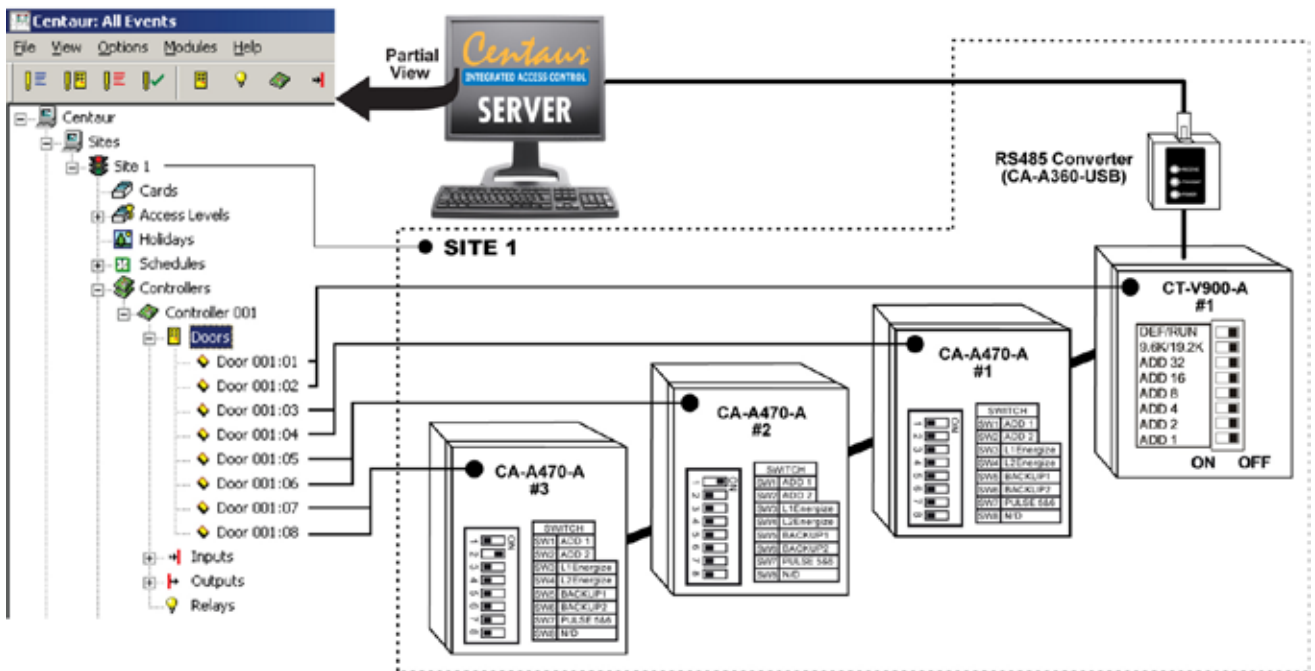

## DELETING A CONTROLLER

To delete an existing controller, right-click the desired controller from the **Controllers** and click **Delete**. You can also click the desired controller and press the keyboard **Delete** key. A dialogue box will appear requesting confirmation.

# CENTAUR

## Integrated Access Control V8.0

### ONLINE CONTROLLER FIRMWARE UPGRADES

---

With the Centaur software there's no need to change the microchips of each controller. Centaur can download the new firmware to the controllers in your installation in just a few easy steps.



---

***When updating the controllers, the controllers cannot control access or perform any other monitoring functions. Therefore, we recommend that firmware updates are performed when traffic is at a minimum and advise users of any interruptions that may occur.***

---

The latest version of the controller firmware can be downloaded from our website at [www.cdvi.ca](http://www.cdvi.ca). Please note that the controller firmware consists of two files, one with a HXL extension and the other with a HXH extension. Also, the file name will indicate the version and release number of the firmware. Use the **View Controller Status** command (see page 114) to verify the application version currently used by the controller.



---

*Each site must be updated separately. We recommend one controller at a time.*

---

### Updating Controller Firmware

Once the firmware files have been downloaded from our website, the controller(s) can be updated within Centaur. Perform the following to update the controller's firmware:

1. Ensure that you are connected (communicating) with the controllers in Centaur. The Centaur software must be running.
2. Within Centaur, expand the desired Site in the Database Tree View window and expand the Controllers branch.
3. From the expanded Controllers branch, right-click on a controller whose firmware you would like to update and click **Update Firmware**.
4. Under the **Firmware Files** heading, browse and select the required HXH file.
5. Click **Update**.
6. Wait for the process to be completed.
7. Click **Close** then wait for the download to be completed.

# CENTAUR

## Integrated Access Control V8.0

## DOWNLOAD

---

The Centaur software can download the following system characteristics to one or all controllers in a site: access levels, cards, controllers, doors, holidays, inputs, input groups, outputs, output timings, relays, relay groups, and schedules. If any system characteristics are set when a controller is online, Centaur will automatically download the information to all controllers in the site.

### When to Use the Download Function

- When you update the controller firmware (see “Online Controller Firmware Upgrades” on ), the controller memory will be erased. The Centaur database is automatically downloaded after the firmware update.
- You can do the following when the **Enable Offline Buffering (Outbox)** check box is not selected (refer to “Enabling Offline Buffering (Outbox)” on page 42):
  - If you wish to program any items without connecting to the site, you must download the system characteristics to the controllers the next time you connect.
  - If you wish to download a particular characteristic to a specific controller in a site, program the desired characteristic without connecting, then connect and download to the desired controller.

### Downloading to One Controllers

1. To download to one controller in a site, from the desired Site, right-click a controller from the **Controllers** list.
2. From the drop-down list, select **Download**.
3. Click **All** or only the specific programming item you wish to download (i.e. doors). Please note that download time depends on the size of the database. Downloading 20 cards will take less time than 3,500 cards.

# CENTAUR

## Integrated Access Control V8.0

## OTHER CONTROLLER MANAGEMENT OPTIONS

---

The following controller management options are also available when you right-click a controller within the **Controllers** of a desired site.

### Updating the Controller Time

The Centaur software can update the date and time of one controller or all controllers in a site. To do so, right-click a controller from the **Controllers** of the desired site, and click **Update Time**. In the Date/Time window, type the required date and time. If you wish to update all controllers in the selected site, select the **Update all controllers on this site** check box. Click **OK**. Also, refer to “Updating the Controller Time Automatically” on page 42.

### Viewing Controller Status

The **View Controller Status** command allows you to view the complete details of each controller. The Centaur software will display the selected controller’s site, address, status, firmware version, number of cards and errors that may have occurred and the controller’s voltage status. To view the controller status, right-click the desired controller from the **Controllers** and click **View Controller Status**.

### Resetting the Controller

To perform a controller reset, right-click a controller from the desired site’s **Controllers** and click **Reset Controller**. This will not affect any items you may have already programmed, such as cards, doors, inputs, etc.



---

If the DIP switch #8 on the controller is set to “default” (left side), performing a controller reset will reset all programming such as cards, doors, and inputs to default.

---

### Activating/Deactivating the Controller

To activate a controller, right-click a controller from the desired site’s **Controllers** and click **Activate Controller**. To deactivate a controller, right-click a controller from the desired site’s **Controllers** and click **Deactivate Controller**.

# CENTAUR

Integrated Access Control V8.0

# CENTAUR

## Integrated Access Control V8.0



## Doors

### What Will I Find?

---

Each controller includes 2 reader and/or 2 keypad inputs, which can monitor the state of up to 2 doors. Each controller also supports up to three 2-Door Expansion Modules (CA-A470-A), which provide an additional 2 reader and/or 2 keypad inputs each. Therefore, each controller can monitor the state of up to 8 doors.

The term **door** refers to any access point controlled by a reader and/or keypad such as a door, turnstile, gate, cabinet, etc. To control entry and exit to an access point, a reader and/or keypad can be used on both sides of the door. This also provides the ability to set up Interlock ("mantrap") or Anti-passback applications.

The use of door contacts on all controlled doors is highly recommended since it greatly enhances the level of security provided by an access control system. Many of the door's programmable options can only be used if a door contact is installed.

# CENTAUR

## Integrated Access Control V8.0

### ADDING DOORS

In order to add one or more doors, at least one site and one controller must be created. If you have not created a site, please refer to “Sites” on page 32. For more information on setting up a controller, refer to “Controllers” on page 98. When adding doors, you will be required to select an address for each door (refer to “Viewing the Door Address” on page 118).

Perform the following to add a door:

1. From the Database Tree View window, right-click the Doors from the desired controller and click **New Doors**. You can also click the Doors and press the keyboard **Insert** key.
2. A dialogue box appears requesting if you would like to use the Door Configuration Wizard. The Door Configuration Wizard guides you through the minimum required settings to set up your doors. If you want to use the Door Configuration Wizard, click **Yes** and follow the steps detailed in “Using the Door Configuration Wizard”. If you do not want to use the Door Configuration Wizard, click **No** and go to step 3.
3. In the **Add Devices** window, select the door address(es) and click **OK**. After adding the door(s), you will have to configure them within the **Door Properties** window (see “Modifying a Door” on page 118).

### Using the Door Configuration Wizard

The Door Configuration Wizard guides you through the minimum required settings to set up your doors.

1. When adding a door, a dialog box appears asking if you would like to use the Door Configuration Wizard. If you click **Yes**, the **Door Defaults** window appears.

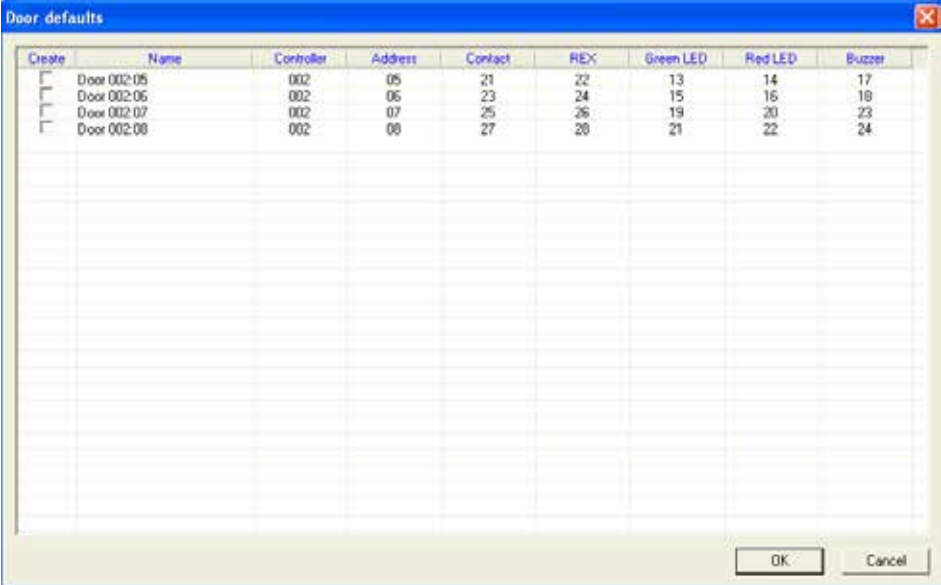

Create	Name	Controller	Address	Contact	REX	Green LED	Red LED	Buzzer
<input type="checkbox"/>	Door 002:05	002	05	21	22	13	14	17
<input type="checkbox"/>	Door 002:06	002	06	23	24	15	16	18
<input type="checkbox"/>	Door 002:07	002	07	25	26	19	20	23
<input type="checkbox"/>	Door 002:08	002	08	27	28	21	22	24

2. Under the **Create** heading, select the check box next to the door address you would like to add.
3. From the **Contact** drop-down list, select the contact's zone input address. If there is no contact associated with the door, select **None**.
4. From the **REX** drop-down list, select the REX's zone input address. If there is no REX associated with the door, select **None**.
5. From the **Green LED** drop-down list, select the green LED's PGM output address. If there is no green LED associated with the door, select **None**.
6. From the **Red LED** drop-down list, select the red LED's PGM output address. If there is no red LED associated with the door, select **None**.

# CENTAUR

## Integrated Access Control V8.0

7. From the **Buzzer** drop-down list, select the buzzer's PGM output address. If there is no buzzer associated with the door, select **None**.
8. To add another door, repeat steps 2 to 7.
9. Click **OK**.

## MODIFYING A DOOR

Right-click the desired door from the **Doors** found within the appropriate controller's branch and click **Properties** from the drop-down list. You can also select the desired door and press the keyboard **Enter** key. The **Door Properties** window will appear, allowing you to configure the door.

### General Door Properties

The **Door** tab will allow you to view some of the system component addresses as well as record the door name and any additional notes.

#### Viewing the Door Address

At the top of the **Door** tab, Centaur will display the door address, as well as the address of the controller and site to which it is connected. The door addresses are represented by which input the door reader and/or keypad is connected to (see "Figure on page 119").



# CENTAUR

## Integrated Access Control V8.0

Controller's Door Address Assignment

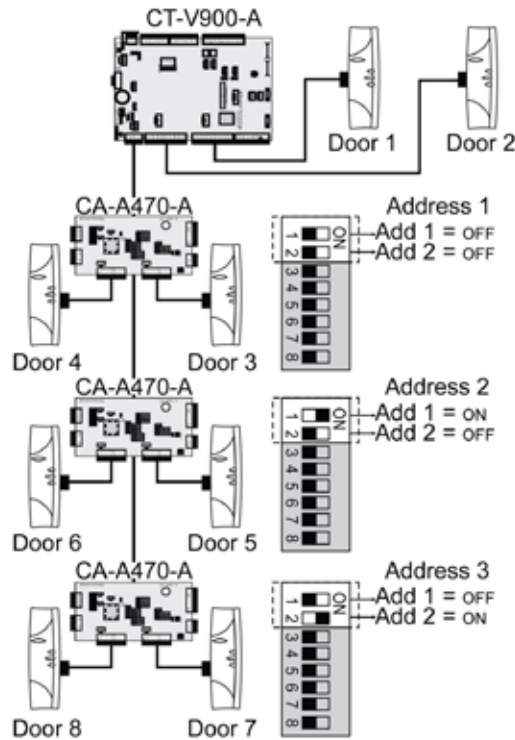

### Typing the Door Name

Use the **Name** text field to identify the door and its location. We recommend using a name that is representative of the door such as "Front Door". Also, refer to "Typing Names and Notes" on page 30.

### Typing the Door Notes

Use the **Notes** text field in the **Door** tab to record any additional notes that may be required. We recommend that you keep a log of what settings were changed and when they were changed. Also, refer to "Typing Names and Notes" on page 30.

# CENTAUR

## Integrated Access Control V8.0

### Door Settings

Each controller includes 2 reader and/or 2 keypad inputs, which can monitor the state of up to 2 doors. Each controller also supports up to three 2-Door Expansion Modules (CA-A470-A), which provide an additional 2 reader and/or 2 keypad inputs each. Therefore, each controller can monitor the state of up to 8 doors.

The term “door” refers to any access point controlled by a reader and/or keypad such as a door, turnstile, gate, cabinet, etc. To control entry and exit to an access point a reader and/or keypad can be used on both sides of the door. This also provides the ability to set up Interlock (“mantrap”) or Anti-passback applications. Centaur enables you to define a specific configuration for each door as well as set the door’s various timers.

### Door Type

Depending on the hardware configuration being used for the selected door, you must select the appropriate door type for the selected door. From the **Door Properties** window, select the **General** tab. From the **Door Type** drop-down list, select the required door type:

#### Access

Select the **Access** door type if you plan to use the controlled entry (one reader access) configuration. This means the reader will be located on one side of a door with no reader on the other side.

#### Elevator

When using CA-A480-A Elevator Controllers (refer to “Elevator Control” on page 146), a reader can be installed inside an elevator. When you select **Elevator** from the **Door Type** drop-down list, Centaur tells the controller that the selected door reader will be installed inside an elevator cart for elevator control. The door cannot be used for any other purpose. Also note that options and features located in the **Elevator Control** tab can only be set when the Door Type is set to **Elevator** (see “Floor Public Access Schedule” on page 130). Each controller door can control up to 64 floors for one elevator cart. Please note that the number of floors is defined per site and not per door (see “Site Floor Settings” on page 46). For example, if you define a site with 20 floors and set up four doors from the same site for elevator control, each door will represent a different elevator cart for the same 20 floors.

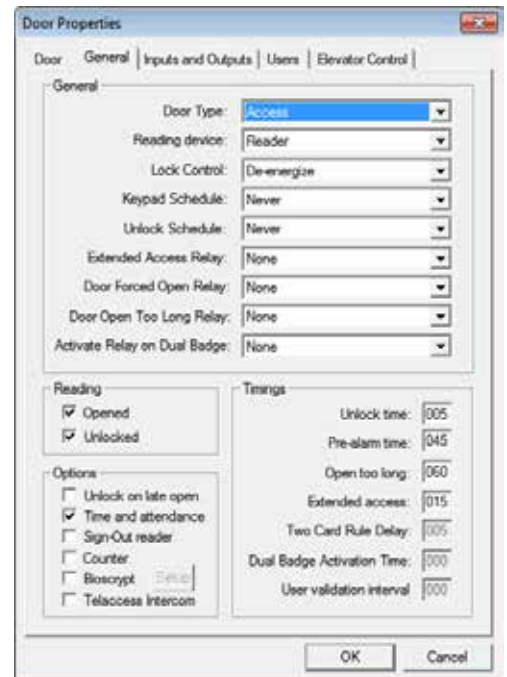

***The Elevator door type cannot be selected for doors located on a 2-Door Expansion Module (doors 3 to 8). Only the controller doors can be set with the Elevator door type.***

#### Entry or Exit

Select the **Entry** door type for the reader located on the entry side of the door and select the **Exit** door type for the exit reader located on the other side of the door. This configuration must be used to implement the local Anti-passback feature (see “Enabling Controller Anti-passback” on page 109).

# CENTAUR

## Integrated Access Control V8.0

### Global Entry or Global Exit

These door types allow you to use global anti-passback, which functions independently and provides more versatility than the local anti-passback feature (see “Enabling Controller Anti-passback” on page 109).

When using Entry and Exit door types (see above), users must enter and exit through a door on the same controller. When using the Global Entry and Global Exit door types, a user can enter through a door defined as global entry, and then the user can exit through any door defined as global exit.

You can also reset the global anti-passback status of all users. For more information, refer to “Selecting a Site’s Global Anti-Passback Reset Schedule” on page 43.



**Global Entry and Exit will only function when the Centaur Server is online (connected). Please note that when using Global Entry and Exit, the Centaur system will also generate a “Waiting for Host” event with every “Access Granted” event generated from a door defined with Global Entry or Exit.**



**Example:** As demonstrated in “Figure 14”, if a user were to enter through door 1 (Global Entry), the user would be able to exit through either door 1 (Global Exit) or door 2 (Global Exit), but not through door 3 since it is not defined as a Global Exit (meaning that the user would still be considered as in).

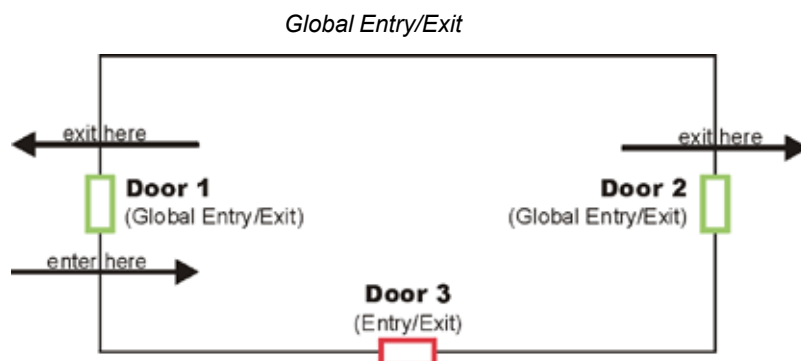

# CENTAUR

## Integrated Access Control V8.0

### *Parking Global Entry or Parking Global Exit*

These door types allow you to use global anti-passback, which functions independently and provides more versatility than the local anti-passback feature.

When using Entry and Exit door types (see above), users must enter and exit through a door on the same controller. When using the Parking Global Entry and Parking Global Exit door types, a user can enter through a parking door defined as global entry, and then the user can exit through any parking door defined as global exit.

You can also reset the global anti-passback status of all users. For more information, refer to “Selecting a Site’s Global Anti-Passback Reset Schedule” on page 43.

### *Global Entry/Exit Validation*

Select the **Global Entry Validation** or **Global Exit Validation** to invalidate a user to proceed to a validation after a pre-defined number of access (see “User validation interval” on page 126).

### *Two Card Rule*

Select the **Two Card Rule** door type when two user credentials are mandatory to access the door. This means that the two users will have to present their cards one after the other within the defined delay as defined in the “Two card rule delay” on page 126 to unlock the door.

## Reading Devices

From the **Reading device** drop-down list, select the device that will be used to obtain access to the door, either a keypad, or a reader.

### *Reader*

If you are connecting a reader, or a reader and a keypad, select **Reader** from the drop-down list. The controller will recognize the use of a keypad if a keypad has been set up in the controller door configuration (see “Selecting the Door Reader and Keypad Configuration” on page 104).

### *Keypad*

If you are connecting only a keypad (no reader) to the door input, select **Keypad** from the drop-down list.

# CENTAUR

## Integrated Access Control V8.0

### Lock Control

From the **Lock Control** drop-down list, select the activation (locking) method that will be used by the door when an “Access Granted” or “Unlock” event occurs.

#### *De-energize*

To operate in **fail-secure** mode (apply power to unlock a door), select **De-energize** from the **Lock Control** drop-down list. This means the selected lock output on the controller will remain de-activated. When an **Access Granted** or **Door Unlocked** event occurs, the controller will apply power to the lock output. If an electric door strike is used, this mode will keep the door locked during a total power loss.

#### *Energize*

To operate in **fail-safe** mode (remove power to unlock a door), select **Energize** from the **Lock Control** drop-down list. This means the lock output on the controller will remain activated. When an **Access Granted** or **Door Unlocked** event occurs, the controller will remove power from the lock output. If an electric door strike or an electromagnetic lock is used, this mode will unlock the door during a total power loss.

### Keypad Schedule

From the **Keypad Schedule** drop-down list, select the schedule that will determine when both a reader and a keypad must be used in order to gain access. When the selected schedule is valid, the user must present a valid card to the reader, and then a valid P.I.N. must be entered on the keypad before access is granted. Only cards with the **Use Keypad** option enabled must enter a valid keypad P.I.N. (see “Use Keypad” on page 130). For more information on schedules, refer to “Schedules” on page 92.

### Unlock Schedule

From the **Unlock Schedule** drop-down list, select the schedule during which a controlled door will automatically unlock. For example, you may want a door to remain open (unlocked) from 9 a.m. to 5 p.m. Monday to Friday. To do so, create the appropriate schedule and select it from the **Unlock Schedule** drop-down list. For more information on schedules, refer to “Schedules” on page 92. Also, refer to “Unlock on Late Open” on page 124.

### Extended Access Relay

From the **Extended Access Relay** drop-down list, select the relay that will be activated when a card with the extended option checked is granted on the door.

### Door Forced Open Relay

From the **Door Forced Open Relay** drop-down list, select the relay that will be activated when the door is forced open.

### Door Open Too Long Relay

From the **Door Open Too Long** drop-down list, select the relay that will be activated when the door is open too long.

### Activate Relay on Dual Badge

From the **Activate Relay on Dual Badge** drop-down list, select the relay that will be activated when a user access this door by presenting his card twice to the door’s reader within the defined dual badge activation time.

# CENTAUR

## Integrated Access Control V8.0

### Setting the Reading Options

Under the **Reading** heading, select one or more of the following check boxes. These check boxes determine how and when a controller will read (log) the presentation of a card to the door's reader.

#### *Opened*

When the **Opened** check box is selected, the controller will continue to read cards presented to the door reader when the door is already opened. This option is commonly used in conjunction with the "Controller Anti-passback Settings" (see page 109) in high-traffic areas. This prevents Anti-passback errors from occurring due to users forgetting to wait until the door is closed before presenting their card.

#### *Unlocked*

When the **Unlocked** check box is selected, the controller will continue to read cards presented to the door's reader when the door is already unlocked. This option is commonly used in conjunction with the "Controller Anti-passback Settings" (see page 109) when the door may be unlocked by a schedule. This prevents Anti-passback errors from occurring due to a user presenting a card to a reader of a door that has already been unlocked by a schedule.

### Selecting the Door options

Under the **Options** heading, select one or more of the following check boxes. These check boxes determine how and when a controller will read (log) the presentation of a card to the door's reader.

#### *Unlock on Late Open*

When "Unlock Schedule" (see page 110), select **Unlock on Late Open** to prevent the door from unlocking automatically until the first user with valid access presents their card at the door.



---

**Example:** The feature is enabled and the front door of an establishment has been programmed to unlock (via schedule) between 8AM and 5PM. If by 8:15 no one has presented their card to the front door's reader, it will not unlock. When the first person arrives at 8:30AM and presents a valid card, the door will remain unlocked until 5PM.

---

#### *Time and Attendance*

When the **Time and Attendance** check box is selected, the time and attendance from the punch device become available for the Pro-Report module.

#### *Sign-Out Reader*

When the **Sign-Out Reader** check box is selected, a visitor is automatically signed out when presenting his card to the door's reader.

#### *Counter*

When the **Counter** check box is selected, the number of times a card can access this door is limited by the time defined in the card properties window (refer to "Enable Counter" on page 143).

#### *Bioscrypt*

When the **Bioscrypt** check box is selected, the use of biometric (Bioscrypt, L1 technology) reader is allowed. Click on the **Setup** button to select the Bioscrypt reader. Enter the IP address of the Bioscrypt reader or click **Find** to select from the detected list. The **Serial Number**, **Unit Type** and **Wiegand Format** of the selected Bioscrypt are displayed.

#### *Teleaccess Intercom*

When the **Teleaccess Intercom** check box is selected, the use of teleaccess intercom is allowed.

# CENTAUR

## Integrated Access Control V8.0

### Setting the Door Timers

Under the **Timings** heading, you can set four different door timers as detailed below.

#### Unlock Time

In the **Unlock time** text field enter a value between 001 and 999 seconds (Default: 5 seconds). This value represents the amount of time the door will remain unlocked when an "Access Granted" or "Unlock" event is generated from the door. The door will only remain unlocked for the entire Unlock Time if the Door Input Relock schedule and REX Input Relock schedule are disabled or if no door input has been programmed. For more information, refer to "Door Inputs and Outputs" on page 126.

#### Pre-alarm Time

Before generating an **Open Too Long** event (see "Open Too Long" below), the controller can be programmed to generate a pre-alarm as a warning of the upcoming alarm. In the **Pre-alarm time** text field, type a value between 001 and 999 seconds (Default: 45 seconds). This value represents the amount of time a door can remain open after an **Access Granted** or **Door Unlock** event before generating a **Door Left Open** event. The **Pre-alarm time** should always be less than the **Open too long time** (see figure below). The controller can also be programmed to activate an output when a **Door Left Open** event is generated (see "Outputs" on page 166).

#### Open Too Long

In the **Open too long** text field, enter a value between 1 and 999 seconds (Default: 60 seconds). This value represents the amount of time a door can remain open after an **Access Granted** or **Door Unlock** event before generating a **Door Open Too Long** event (see figure below). The controller can also be programmed to activate an output when a **Door Open Too Long** event is generated (see "Outputs" on page 166). Also, refer to "Pre-alarm Time" above.

Example of Pre-Alarm and Open Too Long Timers

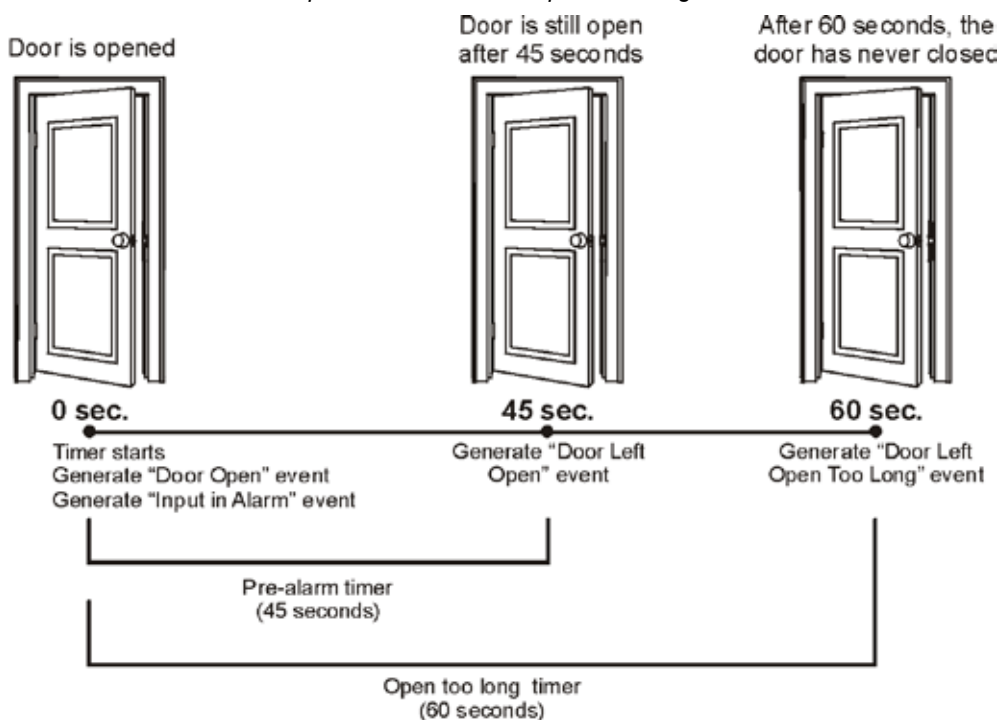

# CENTAUR

## Integrated Access Control V8.0

### Extended Access

When a user is granted access, the controller will unlock the door for the period defined by the “Unlock Time” (see page 125). However, if the card has been programmed with the **Extended** option (see “Setting Card Options” on page 143), the controller will unlock the door for the duration of the **Unlock Time** in addition to the value programmed in the **Extended access** timer. In the **Extended access** text field, type a value between **1** and **999** seconds (Default: 15 seconds). This option is particularly useful for individuals that may require more time to access the door.



**Example:** A card that has the **Extended access** option enabled is granted access to the **Front Door**. This door’s **Unlock Time** is 15 seconds and its **Extended access** timer is 30 seconds. This means the door will remain unlocked for 45 seconds instead of only 15 seconds.

### Two card rule delay

When two users are mandatory to access a specific door, see “Two Card Rule” on page 122, the **Two card rule delay** determines the delay within which the two users have to present their cards in order to grant access to the door. In the **Two card rule delay** text field, type a value between **1** and **999** seconds (Default: 5 seconds).

### User badge activation time

When a card must be presented twice to the door’s reader, see “Activate Relay on Dual Badge” on page 123, the **User badge activation time** determines the time within which the card has to be presented twice to the card reader in order to grant access to the door. In the **User badge activation time** text field, type a value between **1** and **999** seconds (Default: 0 second).

### User validation interval

When a user validation must be made, enter the number of access frequency that will be used to invalidate a user and proceed to the validation. This field is only available when **Global Exit Validation** or **Global Entry validation** has been selected as the door type (see “Door Type” on page 120). Enter a value between **1** and **999** access (Default is 0).

## Door Inputs and Outputs

The **Inputs and Outputs** tab will allow you to specify the configuration for the door input, REX input and its interlock (mantrap) input as well as select which output(s) can be activated for the selected door.

### Assigning a Door Input

After installing a door contact, use the **Door Input** settings to enable the controller to supervise the status of a door (open/closed). A door input is used:

- To generate **Door Open** and **Door Forced** events
- To generate **Open Too Long** and **Door Left Open** events (see “Setting the Door Timers” on page 125)
- To effectively use the Anti-passback feature (see “Controller Anti-passback Settings” on page 109)
- For Interlock (“mantrap”) applications (see “Assigning an Interlock Input” on page 127)

Perform the following to set up a door input:

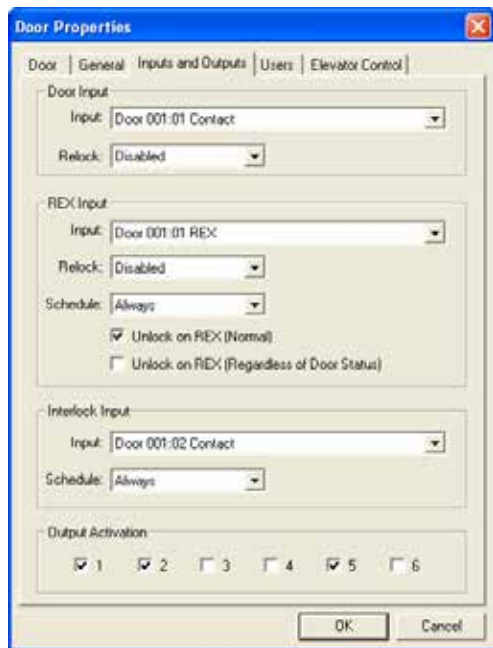

# CENTAUR

## Integrated Access Control V8.0

10. A door contact must be installed above the door and it must be connected to an input on the controller (see the appropriate controller's Installation Manual).
11. The input must be programmed as detailed in "Inputs" on page 156.
12. Under the **Door Input** heading, select the desired input from the **Input** drop-down list.
13. Select a relock option from the **Relock** drop-down list under the **Door Input** heading. After a valid access through the use of a card, the control panel can relock the door as soon as it opens (**Door opening**), when the door closes (**Door closing**), or if you select **Disabled**, it will relock when the Unlock Time has elapsed (see "Unlock Time" on page 125). Also, refer to "Lock Control" on page 123.

### Assigning a REX Input (Request for Exit)

A request for exit (REX) input is required if you have selected the Access (controlled entry) configuration (see "Door Type" on page 120). If you do not use a REX input, the controller will not be able to distinguish between a valid exit and a forced exit. The controller will always generate a "Door Forced" event. Perform the following to set up a REX input:

1. A vertical motion detector must be installed above the door and it must be connected to an input on the controller (refer to the appropriate controller's *Installation Manual*).
2. The input must be programmed as detailed in "Inputs" on page 156..
3. Under the **REX Input** heading, select the desired input from the **Input** drop-down list.
4. From the **Schedule** drop-down list under the **REX Input** heading, select the schedule which will define when the REX can be used.
5. Select a relock option from the **Relock** drop-down list under the **REX Input** heading. After a valid Request for Exit access, the control panel can relock the door as soon as it opens (**Door opening**), when the door closes (**Door closing**), or if you select **Disabled**, it will relock when the Unlock Time has elapsed (see "Unlock Time" on page 125). Also, refer to "Lock Control" on page 123.
6. Select the **Unlock on REX (Normal)** check box if you wish the controller to unlock the door when the controller receives a valid **Request for Exit** (the door must be closed and locked). To unlock the door regardless of its current status (i.e. **Door forced, Door open too long**, etc.), select the **Unlock on REX (Regardless of Door Status)** check box.

### Assigning an Interlock Input

This feature allows you to set up the doors for use with Interlock (**Mantrap**) applications. A "mantrap" consists of two doors, each controlled by a card reader and/or keypad. When one of the two doors is open or unlock, it is impossible to open the other door until both doors are closed. Please note that the selected doors must be from the same controller.

An interlock input is required if the door will be used in a "mantrap" configuration or to generate **Access Denied - Interlock Active** and **Interlock Enabled/Disabled by Schedule** events



---

***The Interlock Inputs feature cannot be used with doors located on a 2-Door Expansion Module (doors 3 to 8). Only the controller's doors can use Interlock Inputs.***

---

Perform these steps for each of the two doors being used in the mantrap configuration.

1. Make sure the door inputs have been programmed (see "Assigning a Door Input" on page 126).

# CENTAUR

## Integrated Access Control V8.0

- From the **Input** drop-down list under the **Interlock Input** heading, select the same input that is assigned to the door input of the other door in the mantrap configuration.
- From the **Schedule** drop-down list under the **Interlock Input** heading, select the schedule which will define when the Interlock (mantrap) configuration can be used.

Notice how the input selected for the **Interlock Input** is the same input used for the opposite door's **Door Input**. This is how the controller determines which two doors are used for the Interlock ("Mantrap") application.

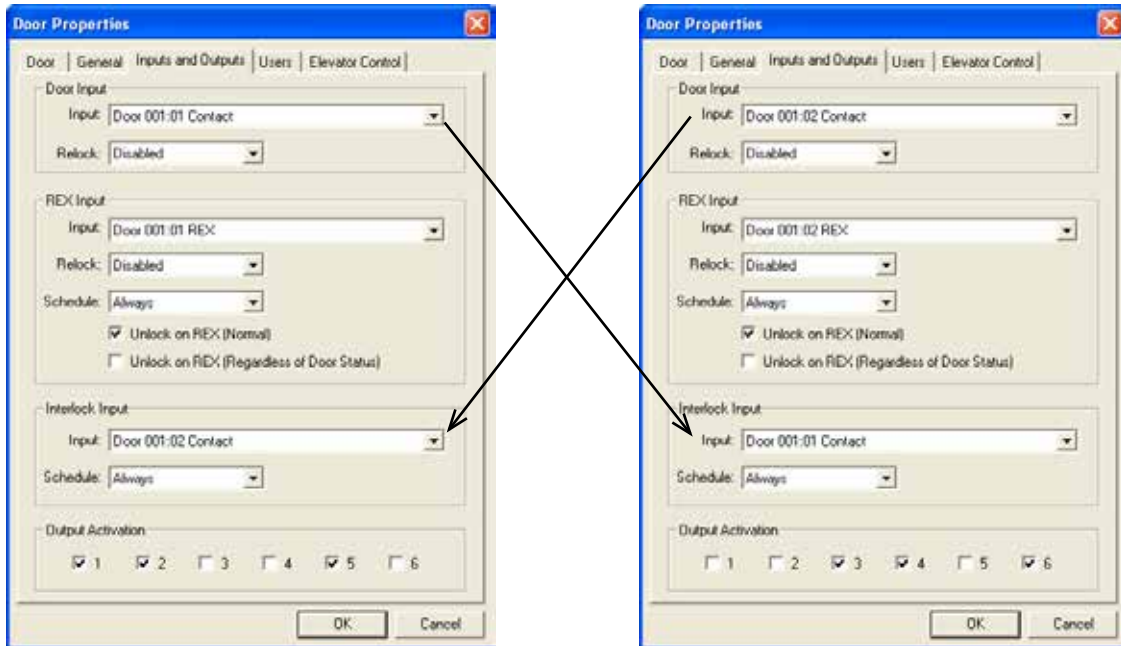

### Assigning Outputs to a Door

Each controller has six multi-function outputs. Each controller also supports up to three 2-Door Expansion Modules (CA-A470-A), which provide an additional 6 outputs each. Therefore, each controller can support a maximum of 24 outputs. Up to 6 outputs can be assigned to the selected door. Typically, these outputs are used to indicate whether a card is granted access and/or the status of the door by activating and controlling the LEDs and buzzers normally found on the readers and keypads.

Depending on the selected door, the **Output Activation** check boxes will be numbered differently. Each group of doors is assigned specific output addresses as demonstrated below:

- **Outputs 1 to 6** belong to **Doors 1 and 2** (controller)
- **Outputs 7 to 12** belong to **Doors 3 and 4** (CA-A470-A: DIP 1 off, DIP 2 off)
- **Outputs 13 to 18** belong to **Doors 5 and 6** (CA-A470-A: DIP 1 on, DIP 2 off)
- **Outputs 19 to 24** belong to **Doors 7 and 8** (CA-A470-A: DIP 1 off, DIP 2 on)

The selected door and its selected outputs must be from the same controller or the same expansion module. For example, outputs 7 to 12 can only be used with doors 3 and 4; they cannot be used with doors 1 and 2, or 5 to 8. When a check mark is placed in the appropriate output check boxes under the **Output Activation** heading, the selected output(s) will operate as defined by the output's programmed features (refer to "Outputs" on page 166).

# CENTAUR

## Integrated Access Control V8.0

### Users

The **Users** tab displays the list of users having access to this door. The access to this door is granted by programming the card access level of the user's card(s). Refer to "Modifying a Card" on page 141 for more information. Each user is displayed using its first name, last name, and the user group he belongs to.

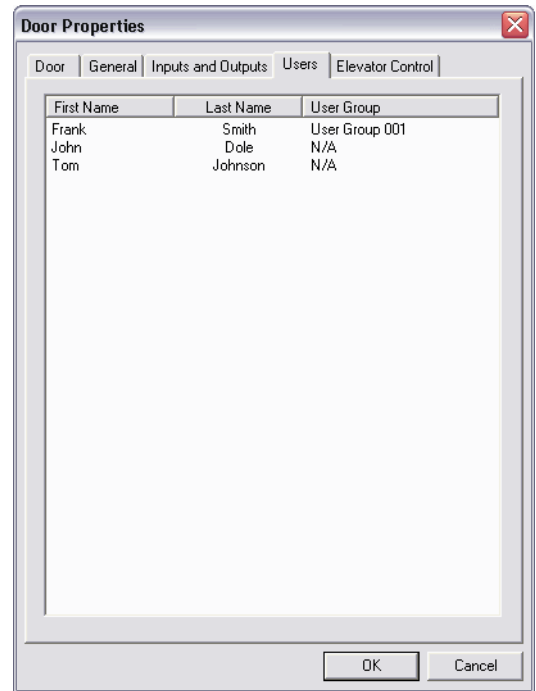

# CENTAUR

## Integrated Access Control V8.0

### Floor Public Access Schedule

When using CA-A480-A Elevator Controllers (refer to “Elevator Control” on page 146), a reader can be installed inside an elevator. Each controller’s door (elevator cart) can be programmed with a general/public access schedule by assigning a schedule to each of the door’s assigned floors. This defines, for the selected door, which floors are accessible to the general public (no access card required) and during which time period. Please note that to program these schedules, the door type must be set to **Elevator** (see “Door Settings” on page 120).

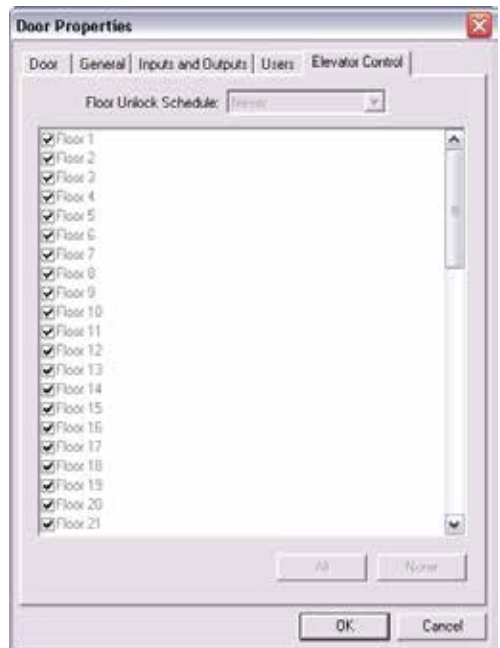

**The Elevator Floor Schedule cannot be used with doors located on a 2-Door Expansion Module (doors 3 to 8). Only the controller’s doors can be set for elevator control.**

### Setting Up a Door Public Access Schedule

Perform the following to assign a schedule to each floor:

1. To assign a schedule to a floor, select the check box associated with the desired floor. The **Schedule** drop-down list will become active.
2. From the **Schedule** drop-down list, select the schedule you would like to assign to the selected floor. Although there is only one **Schedule** drop-down list, you can assign a different schedule to each selected floor. The selected schedule will be assigned to the highlighted floor whose check box is selected.
3. Return to step 2 to assign another floor and schedule, or click **OK** to save and exit.



Example: In “Figure below”, the “Parking Level 2” floor is enabled and has been assigned the “Weekly (General)” schedule. This means that access to that floor is unrestricted when the “Weekly (General)” schedule is valid. Any user, even those without access cards, can access the “Parking Level 2” floor.

Example of Programming a Door’s Floor Schedules

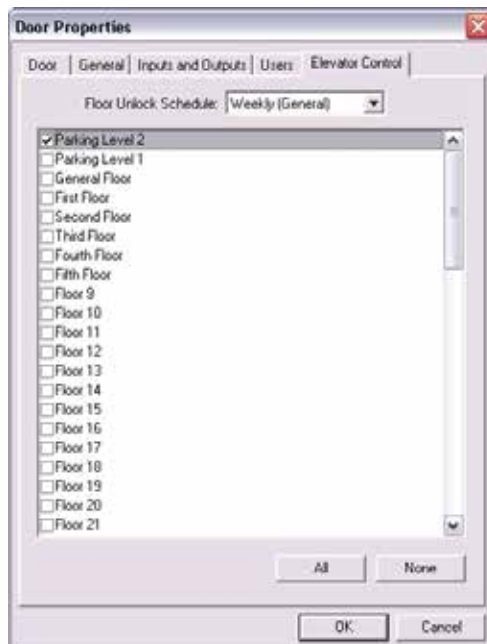

**CENTAUR**

## Integrated Access Control V8.0

**DELETING A DOOR**

---

To delete an existing door, right-click the desired door from the Doors branch and click **Delete** from the drop-down list. You can also select the desired door and press the keyboard **Delete** key. A dialogue box will appear requesting confirmation.

# CENTAUR

## Integrated Access Control V8.0

### DISPLAY DOOR STATUS

When you click on the **Door Status** icon, from the menu bar, Centaur will display the current (live) status of the doors in the system. If you wish to manually change the status of a door, right-click the desired door. You can also use the keyboard **Shift** or **Ctrl** key to select multiple doors if you wish to modify several doors in the same manner at once and then right-click on any of the selected doors. A drop-down list will appear. Select one of the actions from the list. For more information, refer to “Displaying and Controlling the Status of a Door” on page 248.

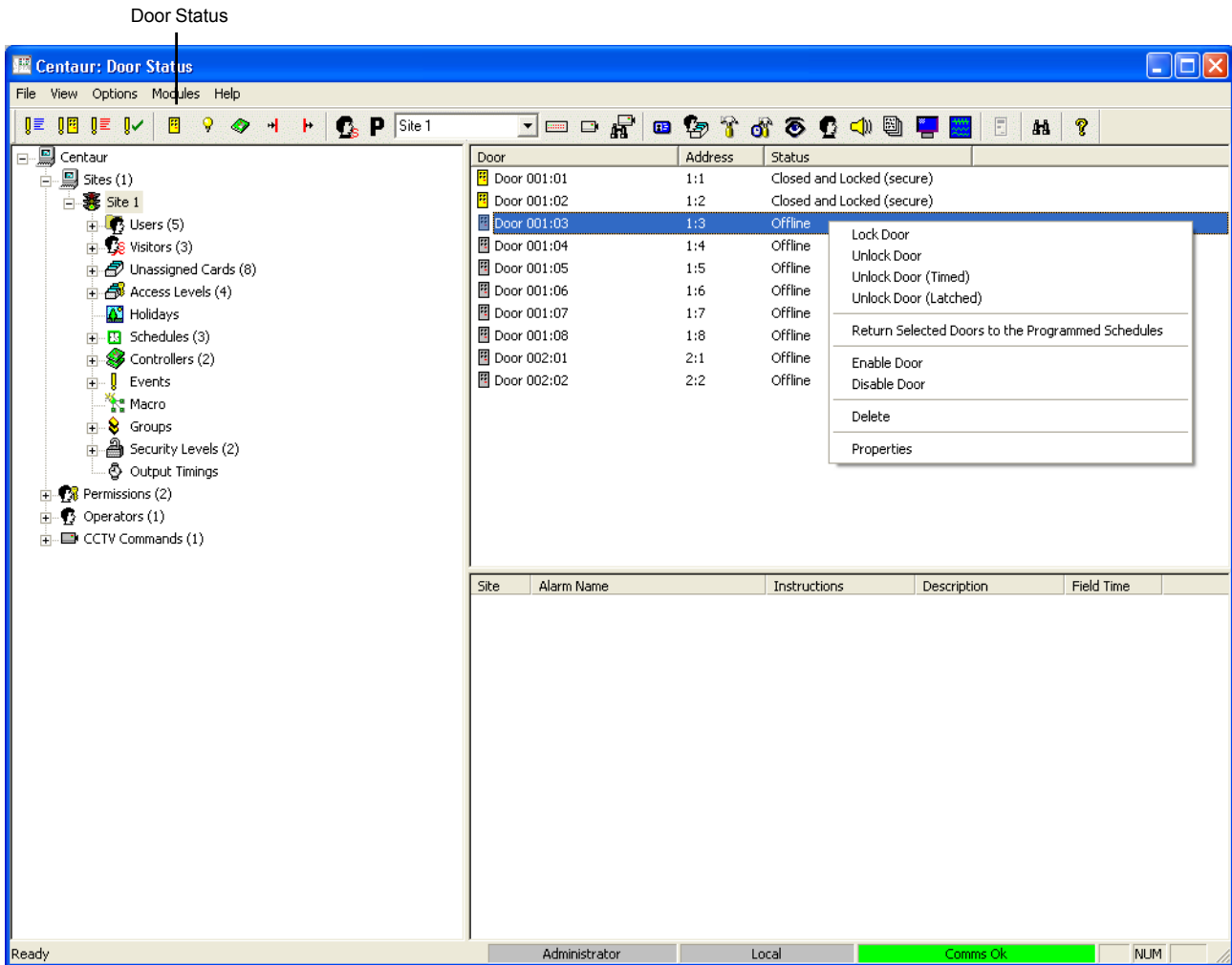

# CENTAUR

Integrated Access Control V8.0

# CENTAUR

## Integrated Access Control V8.0



## Access Levels

### What Will I Find?

---

Access levels determine which doors in the system a user will have access to and during which periods. This is done by enabling the desired doors in an access level, then assigning a schedule to each selected door and assigning the access level to the desired cards. Please note that the 256 access levels include two default access levels (**All** and **None**) which cannot be modified or deleted. The **All** access level provides access to any door that exists in the site, 24 hours a day including any programmed holidays. The **None** access level will deny all access at all times. For information on how the access levels are used, refer to "Cards" on page 138.



---

*In order to program the access levels, you must first program the "Sites" on page 32, the "Doors" on page 116, the "Controllers" on page 98, and "Schedules" on page 92.*

---

# CENTAUR

## Integrated Access Control V8.0

## ADDING AN ACCESS LEVEL

To add an access level, right-click **Access Levels** in the desired Site branch and click **New Access Level** from the drop-down list. You can also click **Access Levels** and press the keyboard **Insert** key to add an access level. After adding an access level, the **Access Level Properties** window will appear, allowing you to configure the access level. See “Modifying an Access Level” for more information.

## MODIFYING AN ACCESS LEVEL

From the desired Site branch in the **Database Tree View window**, right-click the access level you wish to modify and click **Properties** from the drop-down list. You can also select the desired access level and press the keyboard **Enter** key. You cannot modify the default **All** and **None** access levels.

### General Access Level Properties

From this window, select the **Access Level** tab. This will allow you to view some of the system component addresses as well record the access level name and any additional notes.

#### Viewing the Access Level Address

At the top of the **Access Level** tab, Centaur displays the selected site's address as well as the address of the access level. The first access level created is assigned **Access Level: 3** as its address. Every time an access level is added, Centaur increments the access level's address by one. Addresses 1 and 2 are reserved for the **All** and **None** access levels.

#### Enabling the Access Level

Select the **Active** check box to enable the access level, allowing you to assign the access level as required. Clear the **Active** check box to disable the access level without having to remove it from the database (this access level will not work for any card but the cards having other access level will continue to work).

#### Typing the Access Level Name

In the **Name** text field, type a descriptive name for the access level (e.g. Management). Also, refer to “Typing Names and Notes” on page 30.

#### Typing the Access Level Notes

Record any important explanations regarding the access level and its use. Use the **Notes** text field to keep a record of how an access level was changed and when it was changed. Also, refer to “Typing Names and Notes” on page 30.

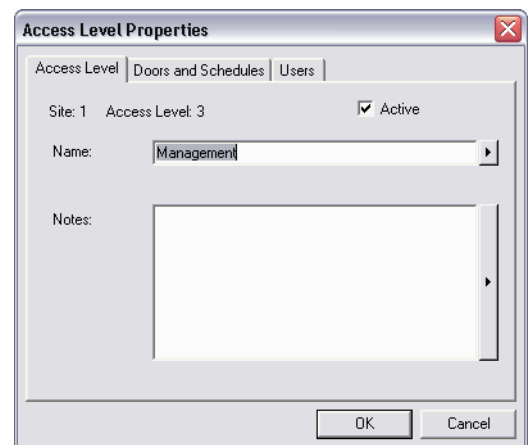

# CENTAUR

## Integrated Access Control V8.0

### Access Level Doors and Schedules

Access levels determine which doors in the system a card will have access to and during which periods. This is done by enabling the desired doors in an access level, then assigning a schedule to each selected door and assigning the access level to the desired cards.

For information on how to create doors, see “Doors” on page 116. For information on how to create schedules, see “Schedules” on page 92. For information on how to assign an access level to a card, see “Cards” on page 138.

#### Assigning Doors and Schedules to an Access Level

Perform the following to define the access level:

1. Select the **Doors and Schedules** tab. A list of all doors that have been created in the site will appear with a check box on the left of each one.
2. To assign a door to the access level, select the check box associated with the desired door. A **Schedule** drop-down list will become active.
3. From the **Schedule** drop-down list, select the schedule you would like to assign to the selected door.
4. Repeat steps step 2-3 to assign another door and schedule or click **OK** to save and exit.

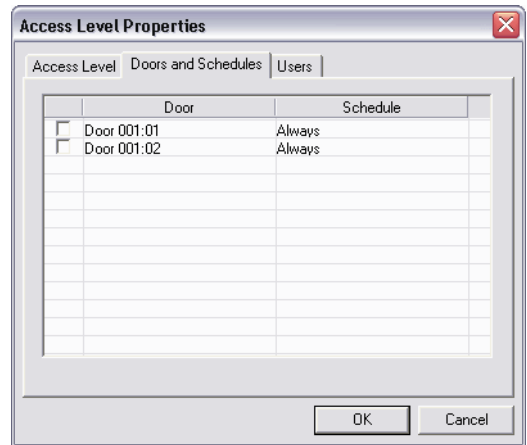

**Example:** In figure below, the **Back Door** is enabled and has been assigned the **General** schedule. This means any card assigned with this access level will be granted access to the back door only when the **General** schedule is valid.

Example of Access Level Programming

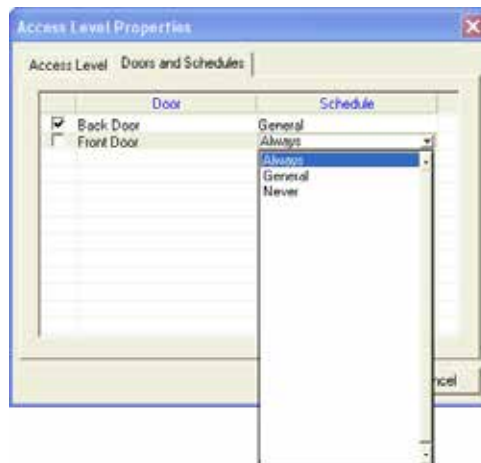

# CENTAUR

## Integrated Access Control V8.0

### User's access level

The **Users** tab displays the list of users having this access level. Each user is displayed using its first name, last name, and the user group he belongs to.



## DELETING AN ACCESS LEVEL

---

In the Database Tree View window (left-hand portion of your screen), right-click the desired access level and click **Delete** from the drop-down list. You can also select the desired access level and press the keyboard **Delete** key. A dialogue box will appear requesting confirmation. You cannot delete the default **All** and **None** access levels.

# CENTAUR

## Integrated Access Control V8.0



## Cards

### What Will I Find?

---

Programming a card allows you to define the card's specific privileges. When setting up the users in the system, you must define WHO has access to WHERE, and WHEN they have access. In order to program the cards, you must first program the site (see "Sites" on page 32), doors (see "Doors" on page 116), holidays (see "Holidays" on page 88), schedules (see "Schedules" on page 92), access levels (see "Access Levels" on page 134), and users (see "Users and User Groups" on page 58). Please note that the number of cards your system can support is also limited by your Centaur edition (refer to "Centaur Editions" on page 9).

# CENTAUR

## Integrated Access Control V8.0



**Example:** In "Figure 18", the card will give access to the "Production Entrance" from 8:00AM to 5:00PM, Monday to Friday including New Year's Day, and 9:00AM to 13:00PM Sunday and Saturday.

### Overview of Card Programming

1 Program the **Holidays** and assign each holiday to one or more **Holiday Groups**.

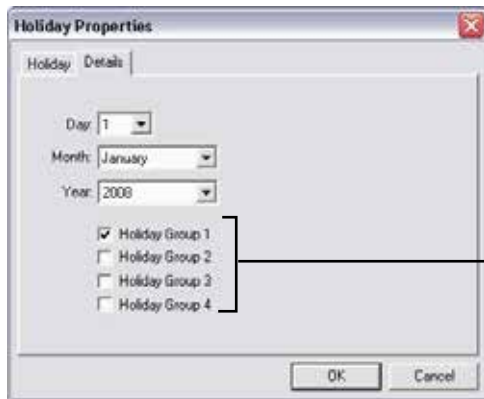

2 Program the periods and assign the desired **Holiday Groups** for each desired **Schedule**.

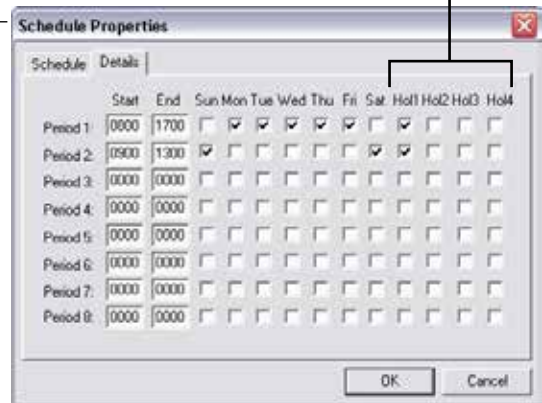

3 Program the **Access Levels** by assigning a schedule to each selected door. Here we programmed the **Production** access level.

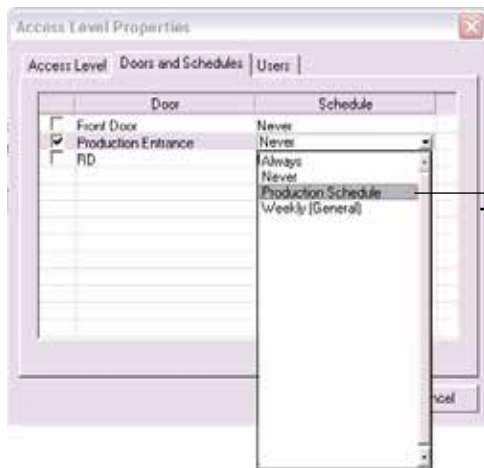

4 Assign the desired **Access Levels** and program the required **Card** properties.

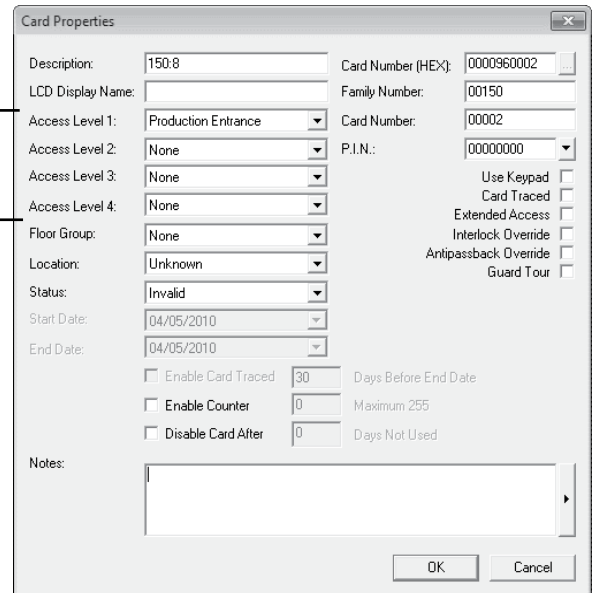

Programming a card allows you to define the card's specific privileges. Cards can be added individually or in batches. You can also add cards within the **User Properties - Cards** window (refer to "Cards" on page 68).

# CENTAUR

## Integrated Access Control V8.0

### ADDING CARDS

In the Database Tree View window, right-click **Unassigned Cards** from the desired Site branch and click **New Card**. You can also select **Unassigned Cards** and press the keyboard **Insert** key. The Card window will appear, allowing you to configure the card properties. Refer to “Modifying a Card” on page 141 for more information.

You can also add a batch of new cards all at once rather than adding each card individually. In the Database Tree View window, right-click **Unassigned Cards** from the desired Site branch and select **New Cards**. Within the **Batch Adding Cards** window, specify how many cards you would like to create as well as any common card information you would like to specify for all cards and click **OK**. Centaur adds the specified amount of cards to your database and auto-increments the card numbers. If you wish to modify the cards, you will have to modify them individually within the Card window (see “Modifying a Card” on page 141).

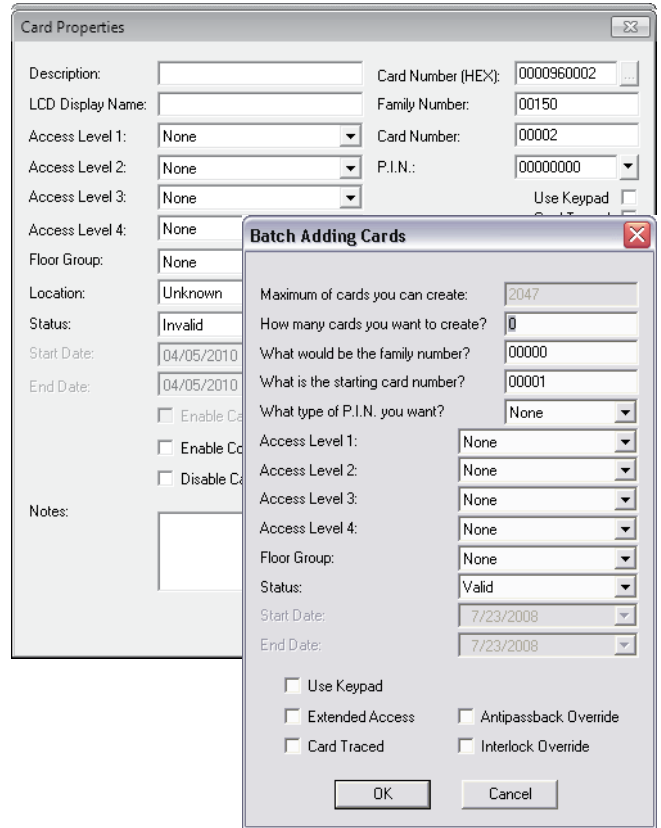

# CENTAUR

## Integrated Access Control V8.0

### MODIFYING A CARD

From the desired Site branch in the Database Tree View window, right-click the card you wish to modify and click **Properties** from the drop-down list. You can also select the desired card and press the keyboard **Enter** key.

#### Card Identification

Use the Description and LCD Display Name fields to identify the card.

##### Description

Use the **Description** text field to identify the card. We recommend using a name that is representative of the card. Also, refer to "Typing Names and Notes" on page 30.

##### LCD Display Name

Use the **LCD Display Name** text field to enter the name of the user that will be displayed on the Tracker LCD when the user punch (needs firmware R2-G3-70 in order to work)

##### Family Number

The family number can be found printed directly on the card or written on a cross-reference sheet. The family number is always the first part of the number and is usually followed by a colon (e.g. **247:1234**). If you cannot locate the family number, you can present the card to any reader in the system and its family and card number will appear in the User/Card field of the Real-Time Events/Status window (see "Figure 19"). When you have located the correct number, type it into the **Family Number** text box. This text box will not be available if the maximum family number is set to 0 (see "Selecting the Cards Maximum Family Number" on page 43).

##### Card Number and Card Number (HEX)

The card number can be found printed directly on the card or written on a cross-reference sheet. The card number is always the second part of the number and is usually preceded by a colon (e.g. **247:1234**). If you cannot locate the card number, you can present the card to any reader in the system and its family and card number will appear in the User/Card field of the Real-Time Events/Status window (see "Figure 19"). When you have located the correct number, type it into the **Card Number** text box. Alternatively, enter the card number in hexadecimal in the **Card Number (Hex)** field when the "Hexadecimal Card Numbers" check box on page 35 is selected. Entering the Card Number in decimal format will affect the Card Number (HEX) field and vice versa.

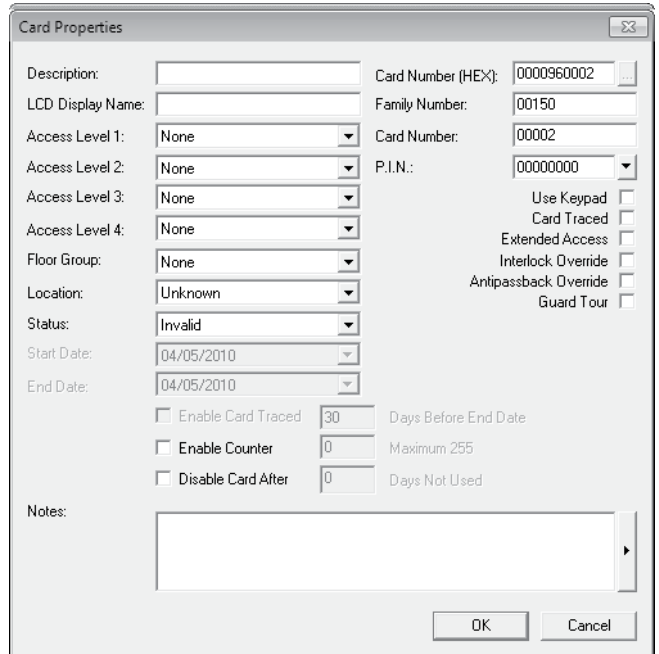

Using the Real-Time Events/Status window to Find Out the Card Number

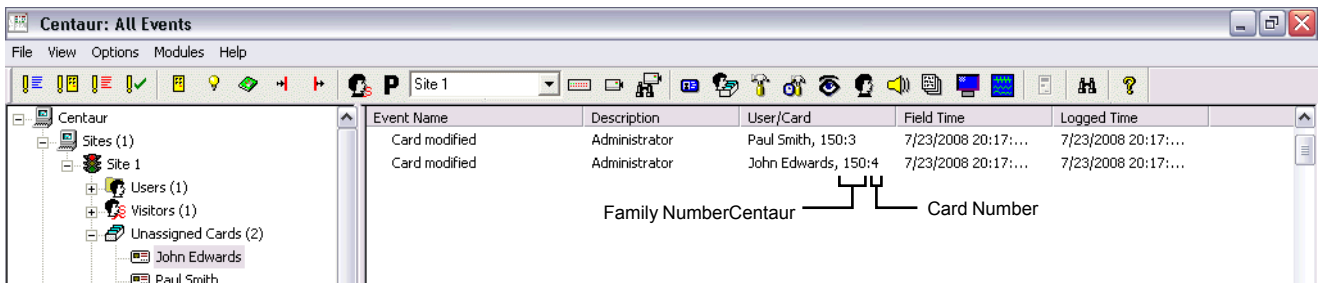

Click on the ... button to load or add a card using a CMPP card enrollment station. This button is only available when the **Activate CMPP** check box is selected (refer to "Activating CMPP for a Site" on page 48).

# CENTAUR

## Integrated Access Control V8.0

### Assigning Access to a Card

The **Floor Group**, **Access Level 1** to **Access Level 4** drop-down lists identify which doors and floors the card can access.

#### *Floor Group*

To obtain access to a door defined for elevator control, the desired cards must be assigned a valid floor group. If the selected site has been set up for elevator control, a list of existing floor groups will appear in the **Floor Group** drop-down list. Select the floor group you wish to assign to the card. This will determine which floors and during which schedule a card will have access. For more information on floor groups, refer to “Groups” on page 186.

#### *Access Level*

Up to two access levels can be assigned to each card by default, and up to four when the “Extended Access Levels (Levels 3/4)” check box is selected (refer to page 42). When you click one of the **Access Level** drop-down lists, all active access levels in the selected site will appear. Select the access level(s) you wish to assign to the card. This will determine which doors in the site the card will have access to and during which time periods each door can be accessed. For information, refer to “Access Levels” on page 134. If two or more access levels are assigned to a card, access is granted as long as one of the defined access levels is valid when the card is presented.

# CENTAUR

## Integrated Access Control V8.0

### Setting Card Options

The following check boxes can be used to enable or disable the corresponding options or features.

#### *P.I.N.*

If the **Use Keypad** check box has been selected (see Use Keypad on page 130), the user will have to type the P.I.N. (Personal Identification Number) recorded in the **P.I.N.** text box on the system keypad. The P.I.N. can be from four to eight digits in length and each digit can be any numerical value from zero to nine. The P.I.N. length is also a function of the keypad hardware being used. If desired, Centaur can automatically generate a unique P.I.N. for you. To do so, click the drop-down arrow to the right of the **P.I.N.** text field and select the desired P.I.N. length.

#### *Use Keypad*

This option is used when a user presents their card to a reader that is accompanied by a keypad on the same side of the door. If the **Use Keypad** check box is selected, the user will have to enter a "P.I.N." (see above) on the keypad after presenting their card to the reader before being granted access.

#### *Card Traced*

Track a user's movements by generating a **Card Traced** event in addition to the **Access Granted** or **Access Denied** event every time the card is used. To enable this feature, select the **Card Traced** check box. You can use Centaur's report generation feature to generate a report of all the **Card Traced** events. The **Card Traced** event can also be used to activate a device such as a relay. The relay can be connected to a signalling device, warning the operator that a card with the **Card Traced** feature enabled has been presented to a reader. For more information, refer to "Events" on page 174.

#### *Extended Access*

When a user is granted access to a door, the door will remain unlocked for the period defined by the door's "Unlock Time" (see page 125). When the **Extended Access** check box is selected, the door will remain unlocked for the duration of the door's "Extended Access" (see page 126) in addition to its **Unlock Time**. This option is particularly useful for individuals that may require more time to access the door.



---

**Example:** A user is granted access to the front door with an **Unlock Time** of 15 seconds and an **Extended Access** time of 30 seconds. If the option is enabled, the door will remain unlocked for 45 seconds instead of only 15 seconds.

---

#### *Interlock Override*

An interlock installation consists of two doors each controlled by a reader. Access will not be granted to a door in this configuration if the other door is already open or unlock. With the **Interlock Override** feature enabled, the user does not have to wait for both doors to be closed in order to access a door using the interlock feature. When using this option and access is granted, the controller will generate an **Access Granted - Interlock Override** event. Also refer to "Assigning an Interlock Input" on page 127.

#### *Anti-passback Override*

When the **Anti-passback Override** check box is selected, all the controllers in the site will ignore the anti-passback status of the card (see "Enabling Controller Anti-passback" on page 109).

#### *Guard Tour*

When the **Guard Tour** check box is selected, the card can be used for guard tour check point validation. Refer to "Guard Tour" on page 190 for more information.

#### *Enable Counter*

When the **Enable Counter** check box is selected, the number of times this card can be used on a door that has its **Counter** option enabled (refer to "Counter" on page 124), will be limited to the number specified, up to 255 times.

# CENTAUR

## Integrated Access Control V8.0

### *Disable Card After*

When the **Disabled Card After** check box is selected, the card will be automatically disabled (unassigned) after the specified number of days of inactivity (up to 365 days).

### Selecting the card location

The **Location** drop list is used to indicate or change the global anti-passback status of a user card: **In**, **Out** or **Unknown**. All user's card location is set to **Unknown** after a reset of the global anti-passback. Refer to **Global Anti-Passback Reset Schedule** on page 43 for more information.

### Selecting Card Status

Each card can be tagged with one of five status levels. These status levels will determine when a user's access card is valid. Click the **Status** drop-down list to select one of the following status levels.

#### *Valid*

As soon as you click **OK**, the card's programmed access privileges are valid and the user can begin using their card until the status is changed.

#### *Stolen, Invalid, or Lost*

These status levels allow you to indefinitely revoke a card's privileges without having to remove it from the database. As soon as you click **OK**, the card can no longer be used until the status is changed.

#### *Temporary*

You can use this status level to create a card prior to the date the card becomes valid or for personnel on contract which would require a card to be active for a specific period of time. When you select **Temporary** from the **Status** drop-down list, the **Start Date**, **End Date**, **Enable Card Traced**, and **Days Before End Date** options become available.

Use the **Start Date** and **End Date** drop-down lists to select the day, month, and year the card becomes valid and the day, month, and year the card expires. The card becomes active at 00:00 of the selected **Start Date** and expires at 24:00 of the selected **End Date**.

When the **Enable Card Traced** check box is selected, a card traced event will be generated when the card is presented within the defined number of days (**Days Before End Date**) before the **End Date**.

### Typing the Card Notes

Use the **Notes** text field to record any additional notes that may be required. We recommend that you keep a log of what settings were changed and when they were changed. Also, refer to "Typing Names and Notes" on page 30.

## DELETING A CARD

---

In the Database Tree View window, right-click the desired card and click **Delete** from the drop-down list. You can also select the desired card and press the keyboard **Delete** key. A dialogue box will appear requesting confirmation.

# CENTAUR

Integrated Access Control V8.0

# CENTAUR

## Integrated Access Control V8.0



## Elevator Control

### What Will I Find?

---

Using the Centaur software, you can control the access of up to 64 floors per site. Each of the CA-A480-A Elevator Controllers can control up to 16 floors and up to eight elevator controllers can be supported by each controller. You can interface the elevator cart's floor buttons with the elevator controllers' relays and program them to follow a public access schedule (no card required) or to limit access to individuals with a valid card. Only the floors that have been assigned to the elevator cart's public access schedule or to a floor group assigned to a card will be active.

# CENTAUR Integrated Access Control V8.0

## OVERVIEW OF ELEVATOR CONTROL

Elevator control allows you to define when certain floors from an elevator cart can be accessed and by whom these can be accessed.

- Each site can control up to 64 floors.
- Each CA-A480-A Elevator Controller controls up to 16 floors.
- Each controller supports up to eight CA-A480-A Elevator Controllers.
- Each door supports four elevator controllers for up to 64 floors.
- Each door in a site represents an elevator cart and each one controls the same floors defined by the site.

Basic Overview of Elevator Controllers

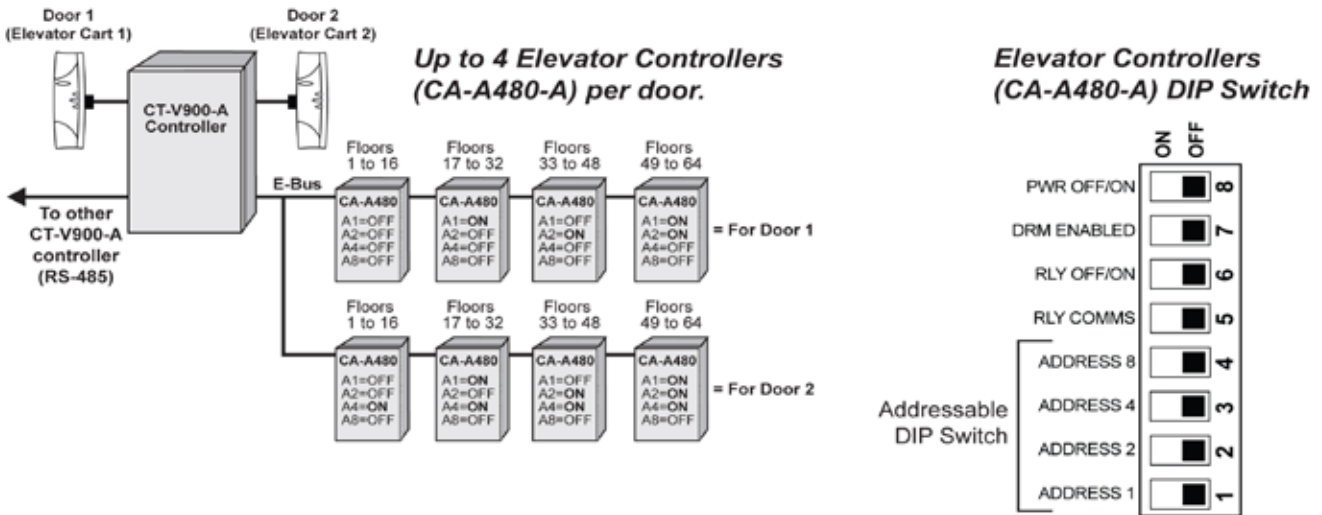

### Quick Start Programming

To properly set up Centaur for elevator control, several different elements must be programmed as defined here:

1. Access the Site Properties window by right-clicking on the desired site from the Database Tree View window and selecting **Properties** from the drop-down list. You can also select the desired site and press the keyboard **Enter** key. In the **Site Properties** window, select the **Floors** tab and define the names and numbers of the site's logical floors (see "Site Floor Settings" on "Site Floor Settings" on page 46).
2. Program the door's reader for elevator control and install it inside the elevator cart. The door cannot be used for any other purpose other than elevator control. Access the Door Properties window by right-clicking on the desired door from the desired controller's branch within the selected site and clicking **Properties** from the drop-down list. You can also select the desired door and press the keyboard **Enter** key. In the Door Properties window of the desired door, select the **General** tab and set the **Door Type** to **Elevator** (see "Door Settings" on page 120). Please note that you cannot use any doors from the 2-Door Expansion Modules for elevator control.

# CENTAUR

## Integrated Access Control V8.0

3. Define when each floor of a door/elevator cart is accessible to the general public (no access card required). In the Door Properties window of the desired door, select the **Elevator Control** tab and assign a schedule to each floor (see "Floor Public Access Schedule" on page 130).
4. To access a floor when its schedule is invalid, you must create a floor group and assign the floor group to the desired cards. Expand the **Groups** branch within the Database Tree View window, right-click on **Floor Groups** and click **New Floor Group** from the drop-down list. You can also select **Floor Groups** and press the keyboard **Insert** key. In the **Floor Group Properties** window, select the **Floors** tab and assign specific floors to the floor group and then assign a schedule and an alternate schedule to the floor group (see "Floor Group's Floors and Schedules" on page 186).
5. Access the Card Properties window of a desired user by right-clicking on the desired user, select **Properties**, select the **Card** tab, select the card from the list then click on **Modify**. Assign a floor group to the card (see "Modifying a Card" on page 141).

Example of Elevator Control

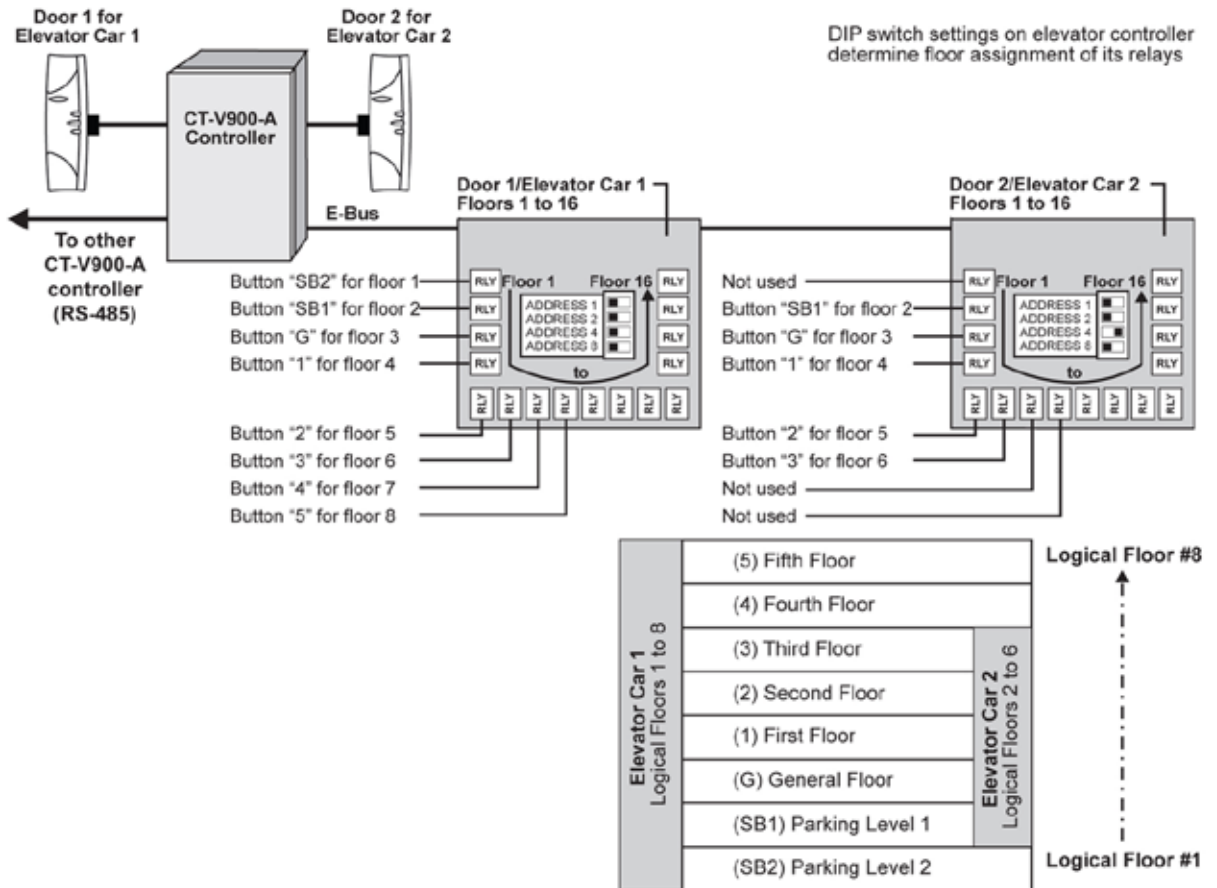

# CENTAUR

Integrated Access Control V8.0

# CENTAUR

## Integrated Access Control V8.0



## Relays

### What Will I Find?

---

The CA-A460-P Relay Expansion Module adds seven additional relays to the CT-V900-A controller. Up to two relay expansion modules can be added to each controller for a total of 16 relays per controller.

Typically, the relays are used to activate alarm sounders or other devices such as lighting control units and air conditioners. The relays can be programmed to follow a schedule or to activate upon the validity of a schedule and disable after a programmed timer has elapsed.

In order to add or create one or more relays, at least one site and one controller must be created. If you have not created a site, please refer to "Sites" on page 32. For more information on setting up a controller, refer to "Controllers" on page 98. When adding relays using the methods described in the following sections, you will be required to select an address for each relay. These addresses represent a specific relay on the selected controller or on a Relay Expansion Module connected to the controller (see figure on page 152).

# CENTAUR

## Integrated Access Control V8.0

### ADDING RELAYS

If you wish to add one relay or multiple relays at one time, right-click **Relays** from the desired controller's branch in the Database Tree View window and select **New Relays**. You can also select **Relays** and press the keyboard **Insert** key. Select the desired relay address(es) and click **OK**. After adding the relay(s), you will have to configure them within the Relay Properties window (see "Modifying a Relay").



### MODIFYING A RELAY

From the desired controller's branch in the Database Tree View window, right-click the relay you wish to modify and click **Properties** from the drop-down list. You can also select the desired relay and press the keyboard **Enter** key.

#### General Relay Properties

From **Relay Properties** window, select the **Relay** tab. The **Relay** tab will allow you to view the component addresses as well as record the relay's name and any additional notes.

#### Viewing the Relay Address

At the top of the **Relay** tab, Centaur will display the relay's address, as well as the address of the controller and site to which it is connected. For details on relay addresses, refer to the figure on page 152. For details on controller addresses, refer to "Viewing the Controller Address" on page 101.

# CENTAUR

## Integrated Access Control V8.0

Relay Address Assignment for Each Controller

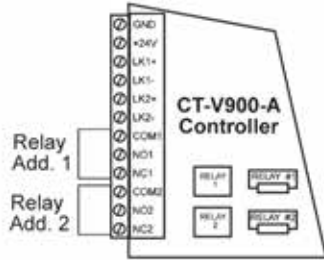

Relays 1 and 2 are found on the controller. Relays 3-16 are found on the relay expansion modules.

A maximum of two relay expansion modules can be connected to the controller.

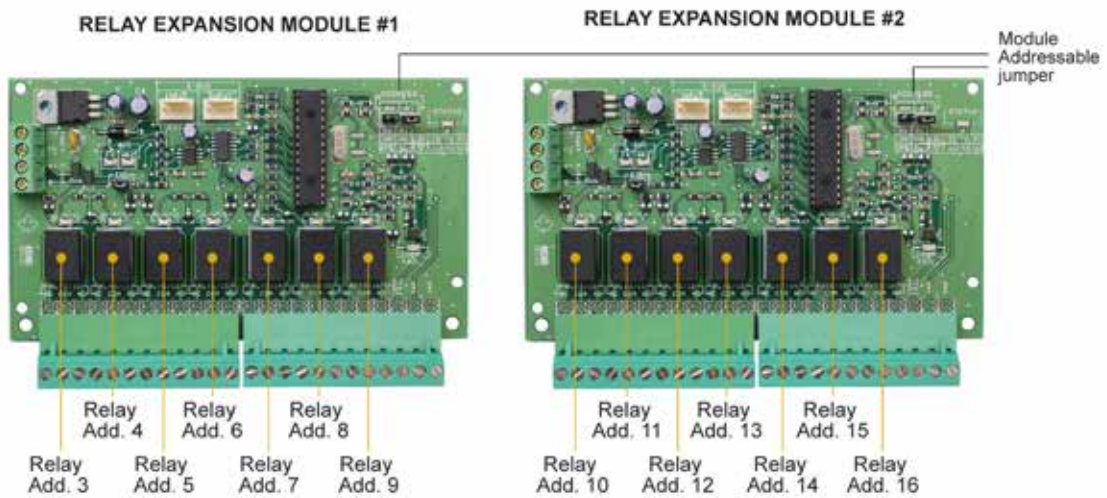

### Typing the Relay Name

Use the **Name** text field to identify the relay’s use or location. We recommend using a name that is representative of the device that it is controlling such as “Alarm Sounder Relay”. Also, refer to “Typing Names and Notes” on page 30.

### Typing the Relay Notes

Use the **Notes** text field to record any additional notes that may be required. We recommend that you keep a log of when and what settings were changed. Also, refer to “Typing Names and Notes” on page 30.

## Relay Activation Properties

From the Relay Properties window, select the **Activation** tab. The **Activation** tab will allow you to program the relay’s activation schedules and activation timers as well as select the relay’s normal state (i.e. de-energized or energized).

### Selecting a Time Relay Activation Schedule

From the **Timed activation** drop-down list under the **Schedules** heading, select the schedule that will activate the relay for the period of time defined by the activation time (see “Setting the Relay Activation Timer” on page 153). At the start time of every period in the selected schedule, the relay will activate for the amount of time specified in the **Activation time** text box, regardless of the schedule’s end times. Refer to “Setting the Relay Delay Time Before Activation” on page 153.

# CENTAUR Integrated Access Control V8.0

### Sample Time Activated Schedule

**Example:** If you wish a relay to activate a bell from Monday to Friday at 8:00AM, 12:00PM, 3:00PM, and 6:00PM for 10 seconds each time, you would program the relay and schedule as follows.

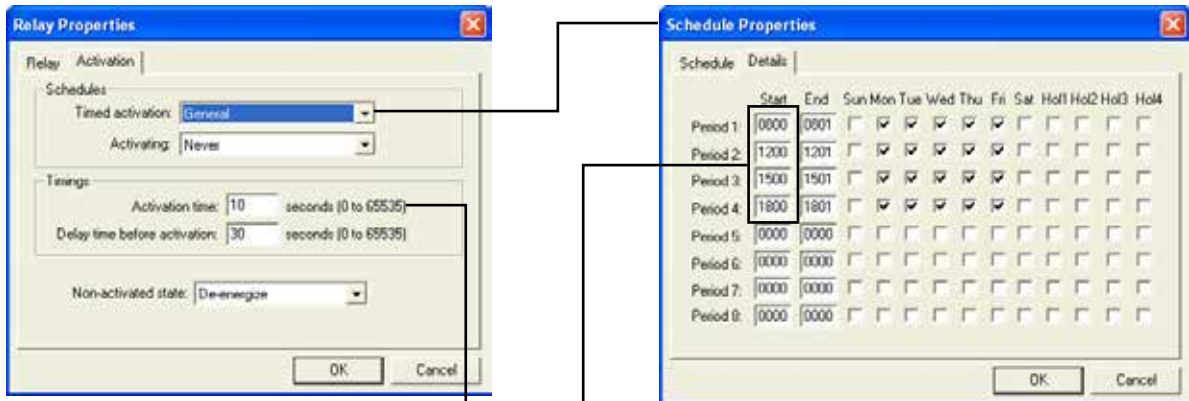

At the **Start** of every period in the selected schedule, the relay will activate for the amount of time specified in the **Activation Time** text box, regardless of the period's **End** time. Relay activation can be delayed by the value programmed in the **Delay time before activation** text box.

### Selecting a Relay Activation Schedule

From the **Activating** drop-down list box under the **Schedules** heading, select the schedule that will activate the relay for the period(s) defined by the selected schedule. This feature will ignore the values programmed under the **Timings** heading and will follow the selected schedule only.

### Setting the Relay Activation Timer

In the **Activation Time** text field under the **Timings** heading, type a value between **0** and **65535** seconds (Default: 5 seconds). This value represents the amount of time the relay will remain activated when enabled by a timed activation schedule (see "Selecting a Time Relay Activation Schedule" on page 139) or when activated manually (see "Displaying and Controlling the Status of a Relay" on page 248).

### Setting the Relay Delay Time Before Activation

In the **Delay time before activation** text field under the **Timings** heading, type a value between **0** and **65535** seconds (Default: 0 second). This value represents the amount of time the controller will wait before activating the relay upon a valid time activation schedule or when activated manually (see "Displaying and Controlling the Status of a Relay" on page 248).



**Example:** A **Delay time before activation** of 30 seconds has been programmed in the example shown in "Figure 23" on page 140. If period 1 of the schedule becomes valid, the relay would activate 30 seconds after 8:00AM.

# CENTAUR

## Integrated Access Control V8.0

### Setting the Relay's Non-Activated State

From the **Non-activated state** drop-down list, select the appropriate normal state.

#### *De-energized*

The relay output is energized when activated. This means the selected relay output on the controller will remain de-energized until activated by a schedule or manually (see “Displaying and Controlling the Status of a Relay” on page 248). When activated, the controller will change the state from off to on.

#### *Energized*

The relay output is de-energized when activated. This means the selected relay output on the controller will remain energized until activated by a schedule or manually (see “Displaying and Controlling the Status of a Relay” on page 248). When activated, the controller will change the state from on to off.

## DELETING A RELAY

---

To delete an existing relay, right-click the relay from the appropriate controller's branch in the Database Tree View window, and click **Delete** from the list. You can also select the desired relay and press the keyboard **Delete** key. A dialogue box will appear requesting confirmation.

## DISPLAY RELAY STATUS AND MANUAL CONTROLS

---

When you click on the **Relay Status** icon from the tool bar, Centaur will display the current (live) status of the relays in the system. If you wish to manually change the status of a relay, right-click the desired relay. You can also use the **Shift** or **Ctrl** keys to select multiple relays if you wish to modify several relays in the same manner at once and then right-click on any of the selected relays. A drop-down list will appear. Select one of the actions from the list. For more information, refer to “Displaying and Controlling the Status of a Relay” on page 248

# CENTAUR

Integrated Access Control V8.0

# CENTAUR

## Integrated Access Control V8.0



## Inputs

### What Will I Find?

---

Each controller includes eight inputs which can be connected using ATZ Zone Doubling to monitor up to 16 input devices. Each controller also supports up to three 2-Door Expansion Modules (CA-A470-A), which provide an additional 4 inputs each. Therefore, each controller can monitor the state of up to 28 inputs.

Typically, the inputs are used to monitor and control the status of door contacts and request for exit devices installed on the controlled door. The inputs can be programmed to follow a schedule, or to activate relays and/or bypass other inputs when triggered. For additional information on how inputs can be used, refer to “Door Inputs and Outputs” on page 126.

# CENTAUR

## Integrated Access Control V8.0

### CONNECTING INPUTS

Each controller and its assigned 2-Door Expansion Modules can monitor the state of up to 28 inputs such as magnetic contacts, motion detectors, temperature sensors or other devices. Inputs can be installed to a maximum distance of 1000m (3300ft.) from the controller when using AWG #22 wire. The controller and its assigned 2-Door Expansion Modules can only use one of the following input connection methods.

#### NC Input Connection

When this option is selected (see Setting the Controller Input Configuration on page 106), the controller will generate an alarm condition when the state of an input is toggled (opened). This set up will not support tamper or wire fault (short circuit) recognition. Connect one device to each input. For address assignment of the 2-Door Expansion Module's inputs, refer to "Viewing the Input Address" on page 160.

#### N.C. Input Connection Methods

##### NC CONNECTIONS FOR CT-V900-A CONTROLLER

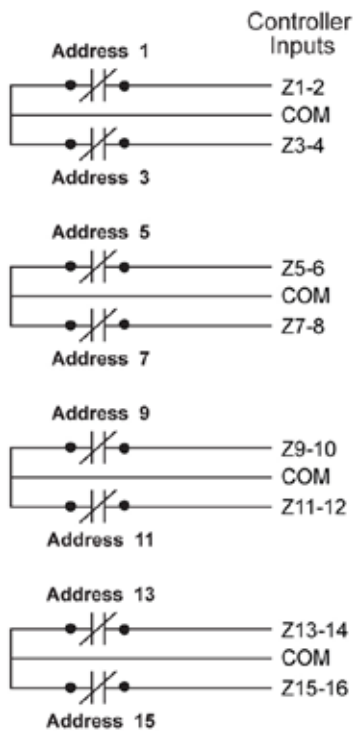

##### NC CONNECTIONS FOR CA-A470-A

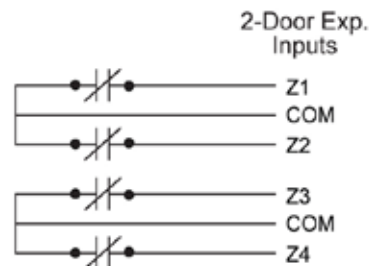

# CENTAUR

## Integrated Access Control V8.0

### ATZ 2R Connection

When this option is selected (see Setting the Controller Input Configuration on page 106), the controller will generate an alarm condition when the state of an input is toggled (opened). An alarm condition will also be generated when a cut in the line occurs, but will not recognize a wire fault (short circuit). Connect two devices to each controller's input, but only one device to each 2-Door Expansion Module's input. For address assignment of the 2-Door Expansion Module's inputs, refer to "Viewing the Input Address" on page 160.

ATZ 2R Input Connection Method

#### ATZ 2R CONNECTIONS FOR CT-V900-A CONTROLLER

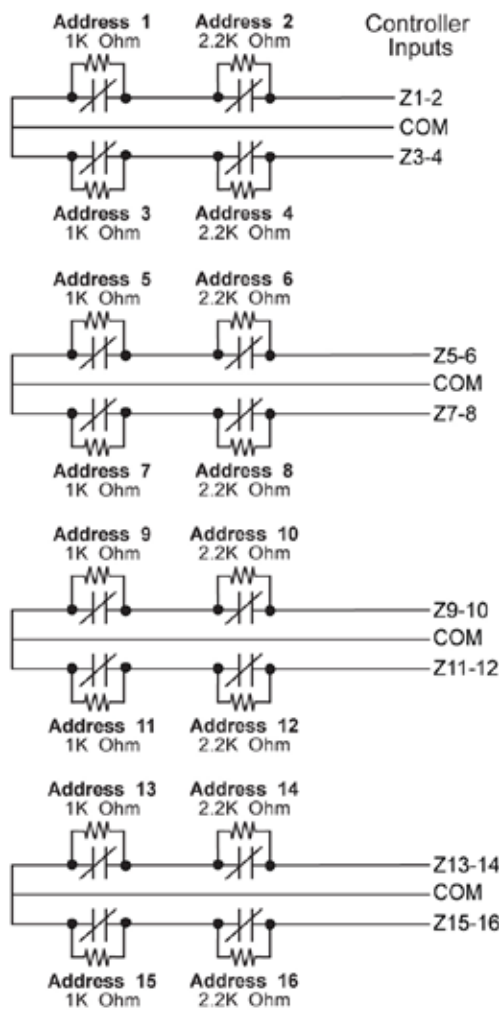

#### ATZ 2R CONNECTIONS FOR CA-A470-A

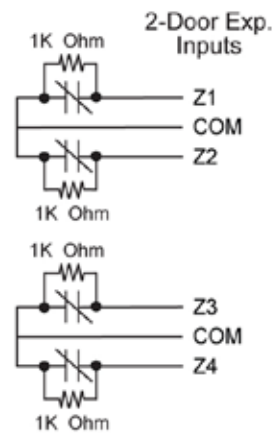

# CENTAUR

## Integrated Access Control V8.0

### ATZ 3R Connection Method

When this option is selected (see Setting the Controller Input Configuration on page 106), the controller will generate an alarm condition when the state of an input is toggled (opened). An alarm condition will also be generated when a wire fault (short circuit) or a cut in the line occurs. Connect two devices to each controller's input, but only one device to each 2-Door Expansion Module's input. For address assignment of the 2-Door Expansion Module's inputs, refer to "Viewing the Input Address" on page 160.

ATZ 3R Input Connection Method

#### ATZ 3R CONNECTIONS FOR CT-V900-A CONTROLLER

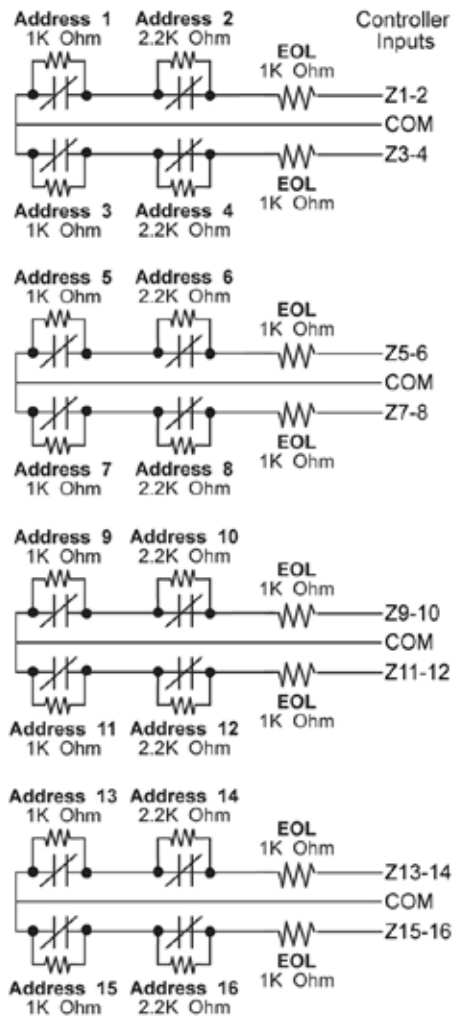

#### ATZ 3R CONNECTIONS FOR CA-A470-A

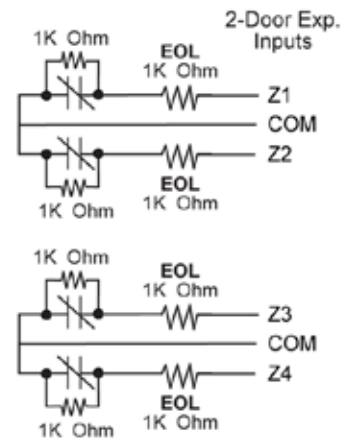

# CENTAUR

## Integrated Access Control V8.0

### ADDING INPUTS

In order to add one or more inputs, at least one site and one controller must be created. If you have not created a site, please refer to “Sites” on page 32. For more information on setting up a controller, refer to “Controllers” on page 98. When adding inputs using the methods described in the following sections, you will be required to select an address for each input. These addresses represent a specific input on the selected controller as described in “Connecting Inputs” on page 157.

To add one input or multiple inputs at one time, right-click **Inputs** from the desired controller in the Database Tree View window and select **New Inputs** from the drop-down list. You can also select **Inputs** and press the keyboard **Insert** key. Select the desired input address(es) and click **OK**. After adding the input(s), you will have to configure them within the **Input Properties** window (see “Modifying an Input” below).



### MODIFYING AN INPUT

From the desired controller’s branch in the Database Tree View window, right-click the input you wish to modify, and click **Properties** from the drop-down list. You can also select the desired input and press the keyboard **Enter** key.

#### General Input Properties

From the **Input Properties** window, select the **Input** tab. The **Input** tab will allow you to view the component addresses as well as record the input name and any additional notes.

#### Viewing the Input Address

At the top of the **Input** tab, Centaur will display the input address, as well as the address of the input controller and site. Please note that the DIP switch settings on each CA-A470-A (2-Door Expansion Module) determines the address assignment of its input terminals as demonstrated in figure on page 161.

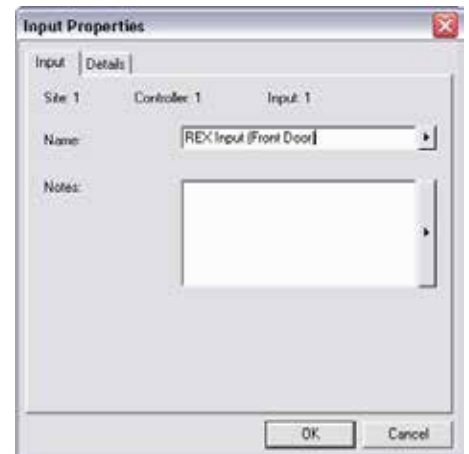

# CENTAUR

## Integrated Access Control V8.0

Overview of the inputs address assignment

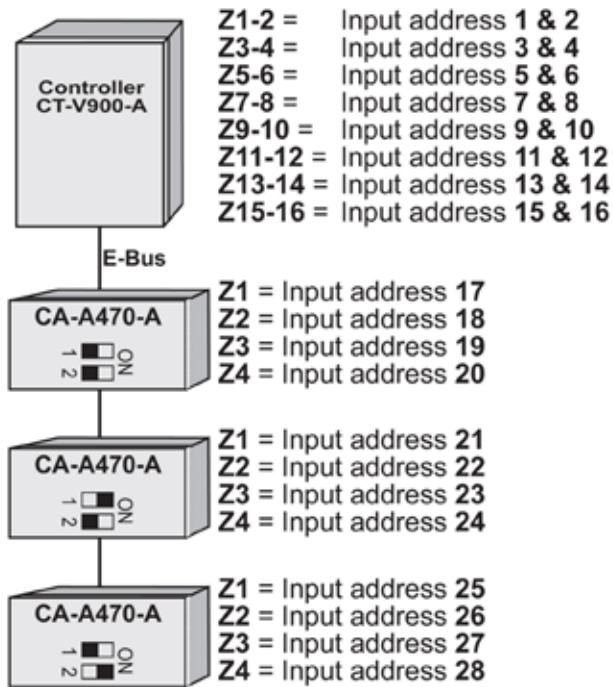

The settings of the DIP switches of each CA-A470-A determine the assignment of the terminal reader or keypad.

### Typing the Input Name

Use the **Name** text field in the **Input** tab to identify the input's use. We recommend using a name that is representative of the device that it is controlling such as "REX Input (Front Door)". Also, refer to "Typing Names and Notes" on page 30.

### Typing the Input Notes

Use the **Notes** text field in the **Input** tab to record any additional notes that may be required. We recommend that you keep a log of when and what settings were changed. Also, refer to "Typing Names and Notes" on page 30.

# CENTAUR

## Integrated Access Control V8.0

### Input Properties

From the **Input Properties** window, select the **Details** tab. The **Details** tab will allow you to configure the input's timers, normal state, schedule and whether a triggered input will bypass an input or activate a relay.

#### Selecting the Input Normal State (N.C./N.O.)

From the **Configuration** drop-down list, select the input's normal state (e.g. Normally Closed or Normally Open). Typically a Normally Closed configuration is used for devices that open upon activation such as door contacts and request for exit detectors. Normally Open configurations are used for devices that close upon activation such as smoke detectors and water level sensors.

#### Selecting the Input Enabling Schedule

From the **Enabling Schedule** drop-down list, select the schedule that will determine when the controller will take into account the input's status (i.e. alarm, restore, etc.). The controller will ignore the state of the input when the selected schedule is invalid. For more information on schedules, refer to "Schedules" on page 96.



#### Setting the Input Response Time

The **Input Response Time** (zone speed) defines how quickly the controller will respond to the triggering of an input. If the input remains triggered for the period defined by the **Input Response Time**, the controller will log the **Input in alarm** event and react according to its programming. This prevents any momentary glitch from causing unnecessary alarms. After adding an input (see "Modifying an Input" on page 160), the Input Properties window can be opened to configure the input. In the **Input response time** text field, type a value from **0** to **65535** ms (65.5 seconds). Please note that once an input is in alarm (input is triggered for the duration of Input Response Time), another alarm won't be generated until the system registers the input as normal or restored (see "Setting the Input Restore Time" below).



**Example:** The Input Response Time is set for 600 ms and an input is triggered, but doesn't stay in that state for at least 600 ms. The controller will not consider the input change state (i.e. no event generation, no alarm, etc.).

#### Setting the Input Restore Time

The **Input Restore Time** defines how quickly the controller will respond to the restoring of an input in alarm. If the input remains restored (in its normal state) for the period defined by the **Input Restore Time**, the controller will log the **Input restore/normal** event and react according to its programming. This only occurs if the input has already generated an alarm. In the **Input restore time** text field, type a value from **0** to **65535** ms (65.5 seconds).

#### Bypassing Inputs with an Input

When an input is triggered, the controller can be programmed to bypass another input or a selected group of inputs. Also refer to the example demonstrated on page 163.

1. From the **This input bypasses input** drop-down list, select which input will be bypassed upon triggering of the input.
2. From the **Bypass input group** drop-down list, select the input group that will be bypassed upon triggering of the programmed input. For more information on input groups, refer to "Groups" on page 184.

# CENTAUR

## Integrated Access Control V8.0

- When an input is programmed to bypass other inputs, the **Bypass Delay** determines how long the input(s) selected in step 1 and step 2 will remain bypassed. The controller will use the Bypass Delay of the input being bypassed, not the input Bypass Delay timer of the triggered input. In the **Bypass delay** field, type a value from **0** to **65535** seconds. If you type a value of 0 second, the controller no longer follows the timer and becomes latched. This means that the input(s) will be bypassed until the selected input is triggered again.

### Example of Bypassing Inputs

In this example when input 1 is triggered, it will bypass input 2 for the period defined by input 2's Bypass Delay (25 seconds).

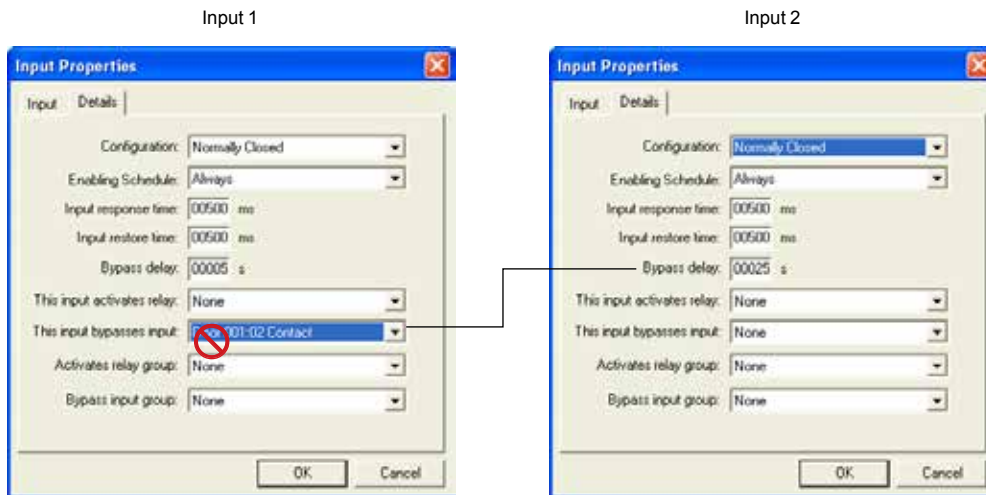

In this example when input 3 is triggered, it will bypass **Door 001:03 Contact**, **Door 001:04 Contact**, and **Door 001:05 Contact** for the period defined by their respective Bypass Delay timers (30 seconds for **Door 001:03 Contact**, **Door 001:04 Contact**, and 125 seconds for **Door 001:05 Contact**).

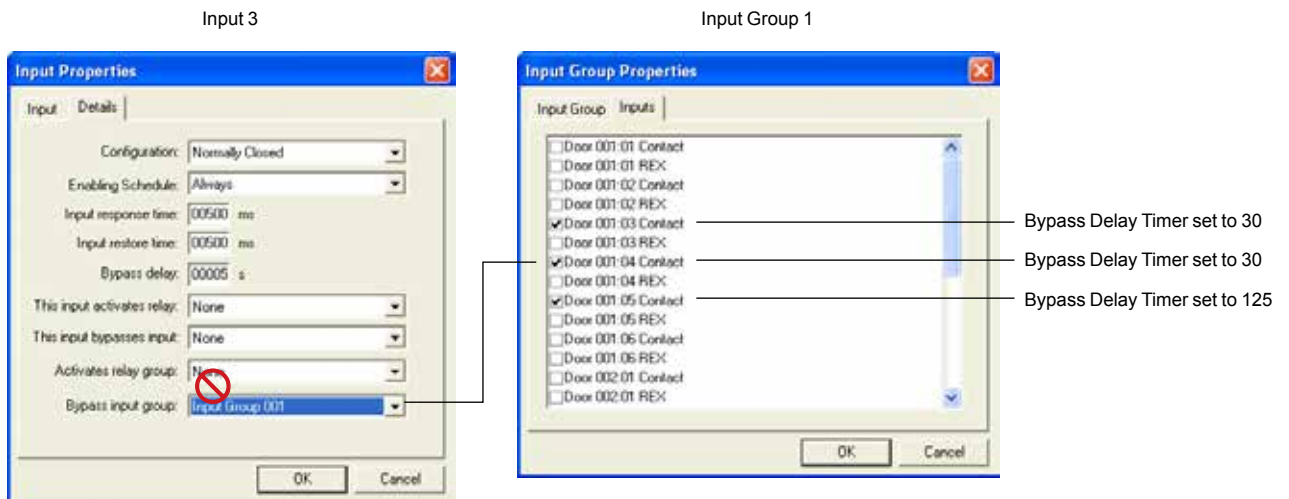

# CENTAUR

## Integrated Access Control V8.0

### Activating Relays with an Input

When an input is triggered, the controller can be programmed to activate one relay or a group of relays. The relay(s) will remain activated for the amount of time defined by the relays' Activation Time (see "Setting the Relay Activation Timer" on page 153). Also refer to the example demonstrated below.

1. From the **This input activates relay** drop-down list, select the relay that will be activated upon triggering of the input.
2. From the **Activates relay group** drop-down list, select the relay group that will be activated by the input.

#### Example of Activating Relays with an Input

In this example when input 2 is triggered, relay 4 will activate for the period defined by relay 4's Activation Time (15 sec.).

Input 2

Relay 4

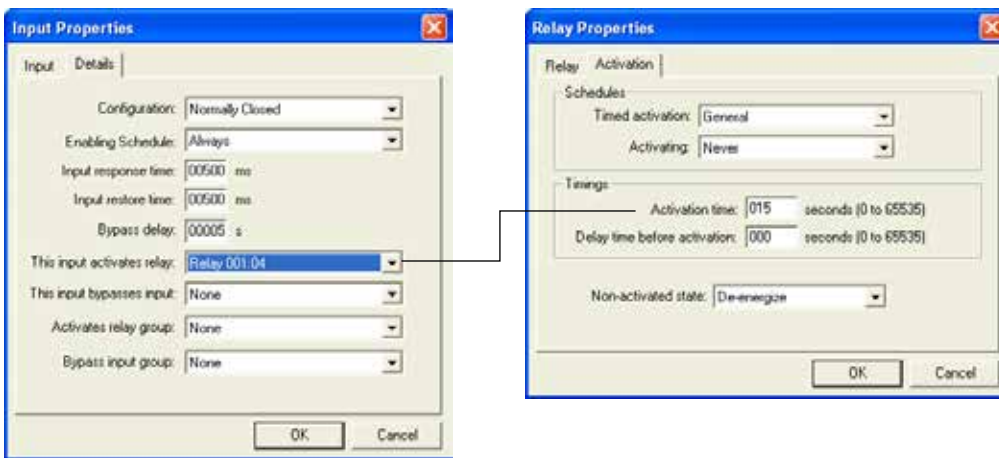

In this example when input 4 is triggered, it will activate relay 3, 4, and 5 for the period defined by their respective Activation Time (15 seconds for relays 3 and 4, and 60 seconds for relay 5).

Input 4

Relay Group 1

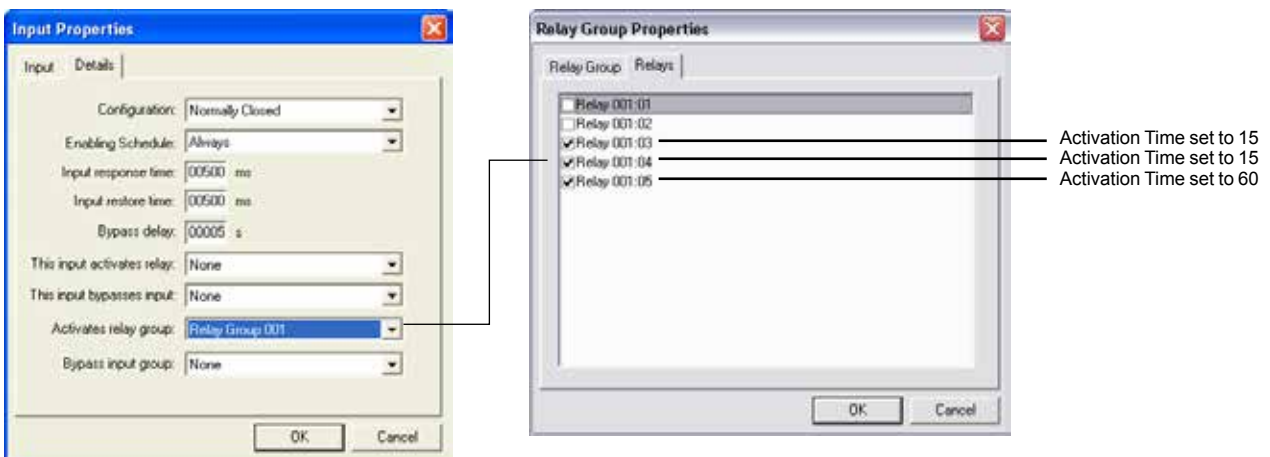

# CENTAUR

## Integrated Access Control V8.0

### DELETING AN INPUT

---

To delete an existing input, right-click the input from the appropriate controller's branch in the Database Tree View window (left-hand portion of your screen), and click **Delete** from the list. You can also select the desired input and press the keyboard **Delete** key. A dialogue box will appear requesting confirmation.

### DISPLAY INPUT STATUS AND MANUAL CONTROLS

---

When you click on the **Input Status** icon from the toolbar, Centaur will display the current (live) status of the inputs in the system. If you wish to manually change the status of an input, right-click the desired input. You can also use the **Shift** or **Ctrl** keys to select multiple inputs if you wish to modify several inputs in the same manner at once and then right-click on any of the selected inputs. A drop-down list will appear. Select one of the actions from the list. For more information, refer to "Displaying and Controlling the Status of an Input" on page 248.

# CENTAUR

## Integrated Access Control V8.0



## Outputs

### What Will I Find?

---

Each controller includes six multi-function outputs. Each controller also supports up to three 2-Door Expansion Modules (CA-A470-A), which provide an additional 6 outputs each. Therefore, each controller can monitor the state of up to 24 outputs. Typically, the controller's outputs are used to control the built-in LEDs and buzzers of the card readers and keypads in the system. For example, a red/green indicator on the reader will inform the user that access has been granted (changes from red to green), or the reader buzzer will inform the card user that the door has been left open or the door has been forced open. You can individually program each output to follow a specific event as well as determine whether the output will be timed, pulsed, or latched.

# CENTAUR Integrated Access Control V8.0

## OVERVIEW OF OUTPUT PROGRAMMING

Each controller includes six on-board multi-purpose outputs and each door can be assigned to activate one or more of these outputs. Each controller also supports up to three 2-Door Expansion Modules (CA-A470-A), which provide an additional 6 outputs each.

Overview of Output Programming

**Centaur: All Events**

- Sites (1)
  - Manufacturing Plant (Montreal)
    - Users (2)
    - Visitors (1)
    - Unassigned Cards (2)
    - Access Levels (3)
    - Holidays (1)
    - Schedules (4)
    - Controllers (1)
      - Controller 001
        - Doors
          - Door 001:01
          - Door 001:02
        - Relays
        - Inputs
        - Outputs
          - Door 001:01 Buzzer
          - Door 001:01 Green LED
          - Door 001:01 Red LED
          - Door 001:02 Buzzer
          - Door 001:02 Green LED
          - Door 001:02 Red LED
  - Events
  - Macro
  - Groups
  - Security Levels (3)
  - Output Timings
  - Permissions (3)
  - Operators (2)
  - CCTV Commands (1)

**Door Properties**

Door Input: REX Input (Front Door)  
Relock: Disabled

REX Input: Door 001:01 REX  
Relock: Door opening  
Schedule: Always  
 Unlock on REX (Normal)  
 Unlock on REX (Regardless of Door Status)

Interlock Input: None  
Schedule: Never

Output Activation:  1  2  3  4  5  6

**Output Properties**

Activation time: 005 seconds (0 to 999)  Inverted

Anti-passback status: Off Wrong code on keypad: On

Access granted: Off Door open: Off  latched

Access denied: On Door forced open: Off  latched

REX granted: Off Reader disabled: Off

REX denied: Off Door open pre-alarm: Off

Access time-out: Off Door open too long: Flashing

Waiting for keypad: Off Door unlocked: On

Keypad time-out: Off

**Output Timing Properties**

	On	Off		On	Off
Anti-passback status:	000	400	Keypad time-out:	050	050
Access granted:	000	000	Wrong code on keypad:	100	100
Access denied:	100	100	Door open:	000	000
Request to Exit granted:	000	000	Door forced open:	000	000
Request to Exit denied:	100	100	Door time-out pre-alarm:	100	250
Access time-out:	050	050	Door open too long:	000	000
Waiting for keypad:	250	250	Door unlocked:	000	000

Notes:

If an output event is programmed with **Flashing**, these settings will determine the output flashing rate

# CENTAUR

## Integrated Access Control V8.0

### ADDING OUTPUTS

In order to add one or more outputs, at least one site and one controller must be created. If you have not created a site, please refer to “Sites” on page 25. For more information on setting up a controller, refer to “Controllers” on page 85. When adding outputs using the methods described in the following sections, you will be required to select an address for each output. These addresses represent a specific output on the selected controller as described in “Output Addresses” Figure below.

If you wish to add one output or multiple outputs at one time, right-click **Outputs** from the desired controller in the Database Tree View window. From the drop-down list, select **New Outputs**. You can also click the desired output and press the keyboard **Insert** key. Select the desired output address(es) and click **OK**. After adding the output(s), you will have to configure them within the Output Properties window (see “Modifying an Output”).

### MODIFYING AN OUTPUT

From the desired controller branch in the Database Tree View window, right-click the output you wish to modify click **Properties** from the drop-down list. You can also click the desired output and press the keyboard **Enter** key.

#### General Output Properties

From the **Output Properties** window, select the **Output** tab. The **Output** tab will allow you to view the component addresses as well as record the output’s name and any additional notes.



#### Viewing the Output Address

At the top of the **Output** tab, Centaur will display the output’s address, as well as the address of the output’s controller and site. Please note that the DIP switch settings on each 2-Door Expansion Module determine the address assignment of its output terminals.

Output Addresses

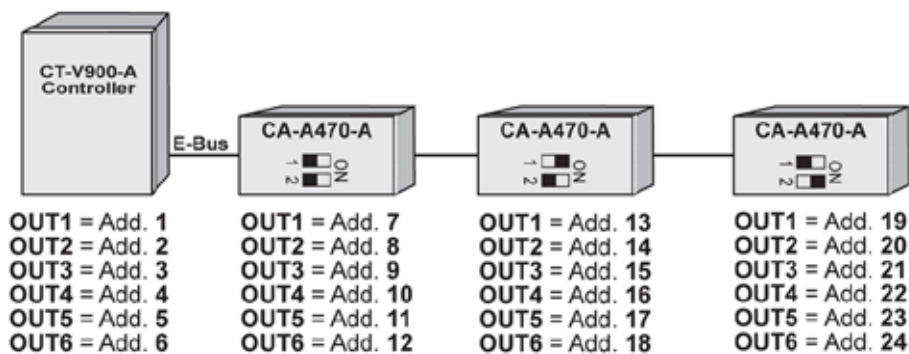

# CENTAUR

## Integrated Access Control V8.0

### Typing the Output Name

Use the **Name** text field to identify the output and its use. We recommend using a name that is representative of the device that it is controlling such as “Door 1 Buzzer”. Also, refer to “Typing Names and Notes” on page 30.

### Typing the Output Notes

Use the **Notes** text field in the **Output** tab to record any additional notes that may be required. We recommend that you keep a log of when and what settings were changed. Also, refer to “Typing Names and Notes” on page 30.

## Output Settings

Each controller includes six multi-function outputs. Each controller also supports up to three 2-Door Expansion Modules (CA-A470-A), which provide an additional 6 outputs each. Therefore, each controller can monitor the state of up to 24 outputs. Typically, the controller’s outputs are used to control the built-in LEDs and buzzers of the card readers and keypads in the system. You can individually program each output to follow a specific event as well as determine whether the output will be timed, pulsed or latched. Also, refer to “Overview of Output Programming” on page 167. Determine how the six outputs will be used. Typically they are set up as follows:

- Output 1 - Access Granted for Door 1 (green LED)
- Output 2 - Access Denied for Door 1 (red LED)
- Output 3 - Access Granted for Door 2 (green LED)
- Output 4 - Access Denied for Door 2 (red LED)
- Output 5 - Beeper for Door 1 (buzzer)
- Output 6 - Beeper for Door 2 (buzzer)

### Setting the Output Activation Events

You can program the output to activate upon the occurrence of one or more selected events. After setting the activation events for all required outputs, you must determine which outputs can be activated by each door (see “Assigning Outputs to a Door” on page 128). For example, if the “Access Granted” event is set to **On** for output 2, but output 2 has not been assigned to a door, the output will never activate. To set the output’s activation events, perform the following:

1. From the Output Properties window, select the **Events** tab.
2. In the **Events** tab you will find 15 events, which are described in the following sections. Each event has a drop-down list allowing you to select **Off**, **On**, or **Flashing**. Select the desired setting for each event.



- If you select **Off**, the selected event will never activate the output.
- If you select **On**, the output will activate for the amount of time defined by the **Activation Time** (see step 4) when the corresponding event occurs.
- If you select **Flashing**, the output will activate for the amount of time defined by the **Activation Time** (see step 4) and will flash according to the rate defined by the programmed Output Timings (see “Setting a Flashing Output’s On/Off Timers” on page 158) when the corresponding event occurs.

# CENTAUR

## Integrated Access Control V8.0

3. Six of these events also have a **latched** check box. If the **latched** check box is selected, the output will ignore the **Activation Time** and instead will follow the event that activated it. This means the output will deactivate when the event is restored.
4. In the **Activation time** text field, type a value from 0 to 999 seconds. If an event is set to **On** or **Flashing** (see step 2) and the event occurs, the output will activate for the amount of time defined here unless the **latched** check box is selected.
5. Selecting the **Inverted** check box will reverse the output's normal condition to ON. Therefore, when activated, the output will turn OFF and when the output is deactivated, the output will turn ON.
6. Click **OK**.

### *Anti-passback status*

If the Anti-passback feature is enabled (see "Controller Anti-passback Settings" on page 109 and a controller registers two subsequent Entries or two subsequent Exits, the appropriate "Access Denied - Anti-passback violation" event will be generated and the output will be activated.

### *Access granted*

The output can activate when access has been granted to the door following the presentation of a valid card or keypad code.

### *Access denied*

The output can be activated when access has been denied to the door following the presentation of an invalid card or keypad code.

### *REX granted*

The output can activate when a request for exit device (vertical detector) assigned to a door's REX input (see "Assigning a REX Input (Request for Exit)" on page 127 has been triggered.

### *REX denied*

The output can be activated when a "REX denied" event occurs other than the "REX Denied - Schedule Invalid" event (i.e. interlock enabled).

### *Access time-out*

The output can be activated when access has been granted, but the door was never opened during the unlock period (see "Unlock Time" on page 125 and "Extended Access" on page 126).

### *Waiting for keypad*

When both a reader and a keypad are required for access (see "Use Keypad" on page 143), the output can be activated as soon as the reader has granted access.

### *Keypad time-out*

When both a reader and a keypad are required for access (see "Use Keypad" on page 143), the output can be activated when the reader grants access, but no P.I.N. is entered on the keypad within 30 seconds.

### *Wrong code on keypad*

The output can be activated when an incorrect code is entered on a keypad after a valid access card is presented (see "Use Keypad" on page 143)).

### *Door open*

The output can be activated whenever an access control door is opened (see "Assigning a Door Input" on page 126). Also, when using this event, the output can be latched.

# CENTAUR

## Integrated Access Control V8.0

### *Door forced open*

The output can be activated whenever an access control door is forced opened (see “Assigning a Door Input” on page 126). Also, when using this event, the output can be latched.

### *Reader disabled*

The output can be activated whenever a programmed door has been manually disabled (see “Displaying and Controlling the Status of a Door” on page 248). Also, when using this event, the output can be latched.

### *Door open pre-alarm*

The output can be activated whenever a “Door Left Open” event occurs. This occurs when the door has been open for the duration of the Pre-alarm timer (see “Pre-alarm Time” on page 125). Also, when using this event, the output can be latched.

### *Door open too long*

The output can be activated whenever a “Door Open Too Long” event occurs. This occurs when the door has been open for the duration of the Open Too Long Timer (see “Open Too Long” on page 125). Also, when using this event, the output can be latched.

### *Door unlocked*

The output can be activated whenever an access control door is unlocked. Also, when using this event, the output can be latched.

## Setting a Flashing Output’s On/Off Timers

If any of the output’s selected events have been set to **Flashing** (see “Setting the Output Activation Events” on page 169), you must define the rate of the output’s flashing for each event. The Output Timings are programmed for each event and not per output, therefore affecting all outputs. To do so:

1. Right-click **Output Timings** from the Database Tree View window and click **Properties** from the drop-down list to display the Output Timing Properties window. You can also select **Output Timings** from the Database Tree View window and press the keyboard **Enter** key.
2. In the **Timings** tab, you will find the same events that are found in the **Events** tab of the Output Properties window (see “Setting the Output Activation Events” on page 169)).
3. In the **On** and **Off** text fields, type a value from 0 to 999 milliseconds. This will set the rate of flashing for the output.
4. Click **OK**.

Use the **Reset to factory default** button to restore the default factory timing for each event.



## DELETING AN OUTPUT

---

To delete an existing output, right-click the output from the appropriate controller branch in the Database Tree View window and click **Delete**. You can also click the desired output and press the keyboard **Delete** key. A dialogue box will appear requesting confirmation.

## DISPLAY OUTPUT STATUS AND MANUAL CONTROLS

---

When you click on the **Output Status** icon from the toolbar, Centaur will display the current (live) status of the outputs in the system. If you wish to manually change the status of an output, right-click the desired output. You can also use the **Shift** or **Ctrl** keys to select multiple outputs if you wish to modify several outputs in the same manner at once and then right-click on any of the selected outputs. A drop-down list will appear. Select one of the actions from the list. For more information, refer to “Displaying and Controlling the Status of an Output” on page 248.

# CENTAUR

Integrated Access Control V8.0

# CENTAUR

## Integrated Access Control V8.0



## Events

### What Will I Find?

---

Every event that occurs in the system can be programmed to perform a series of actions. Schedules can be assigned to each event defining when the event will be displayed on the screen and when it will be saved in the database. Select which device (i.e. relay) can be activated, when it can be activated and the length of activation. A schedule defines when an event will require operator acknowledgement while providing the operator with detailed instructions.

# CENTAUR

## Integrated Access Control V8.0

### EVENT DEFINITION OVERVIEW

Every event that occurs in the system can be programmed to perform a series of actions. The event definitions are programmed separately for each site in the system. A default event definition for all devices and/or users can be created as well as separate event definitions for each event-related device, user, and visitor.

1. To select the desired event, double-click **Events** from the desired Site branch in the Database Tree View window. Right-click the desired event and select **Properties**. You can also select the desired event and press the keyboard **Enter** key. The event's properties window will appear.

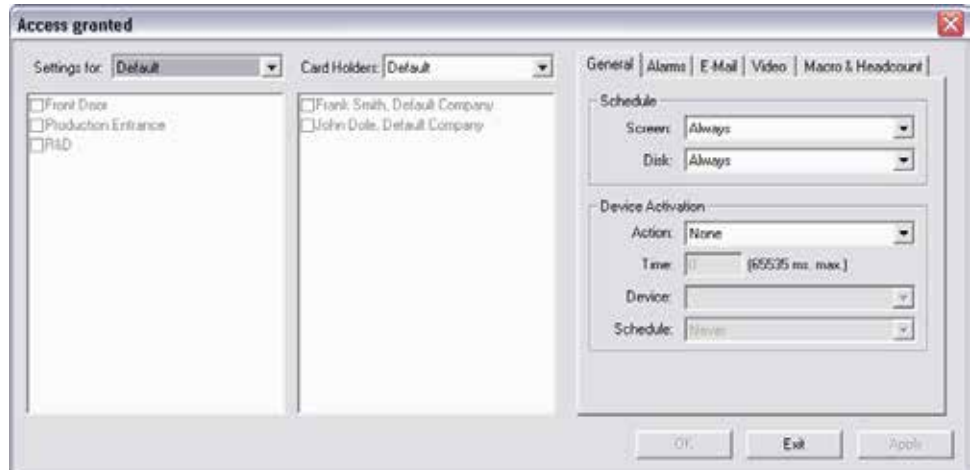

2. A list of devices related to the selected event will appear in the event's properties window. From the **Settings for** list, select either **Default** (see "Programming a Default Event Definition" on page 176) or **Devices** (see "Programming a Device-Specific Event Definition" on page 176). If necessary, select one or more devices from the list.
3. A list of users related to the selected event will appear in the event's properties window. From the **Users** list, select either **Default** (see "Programming a Default Event Definition" on page 176), **User**, or **Visitor** (see "Programming a Device-Specific Event Definition" on page 176). If necessary, select one or more users from the list.
4. Program the event's definitions using the **General** tab (see "Event Schedules and Device Activation" on page 177), the **Alarms** tab (see "Alarm Acknowledgement" on page 179), the **E-Mail** tab (see "E-Mail Activation" on page 181), the **Video** tab (see "Event-Activated Video Control" on page 182), or the **Macro & Headcount** tab (see "Macro & Headcount" on page 183).
5. Click **Apply** and click **OK**. The selected event will appear in bold under **Events** in the Database Tree View window to indicate that changes were made.

# CENTAUR

## Integrated Access Control V8.0

### Programming a Default Event Definition

A default event definition enables you to program the same settings for more than one device and user (usually to apply to all devices and users in the list). When you select **Default** from the **Settings for** and **Users** drop-down list (see step 2 and step 3 in “Event Definition Overview”), the definitions that you program in the **General**, **Alarms**, **E-Mail**, **Video**, and **Macro & Headcount** tabs will apply to all devices and users whose check boxes are cleared.

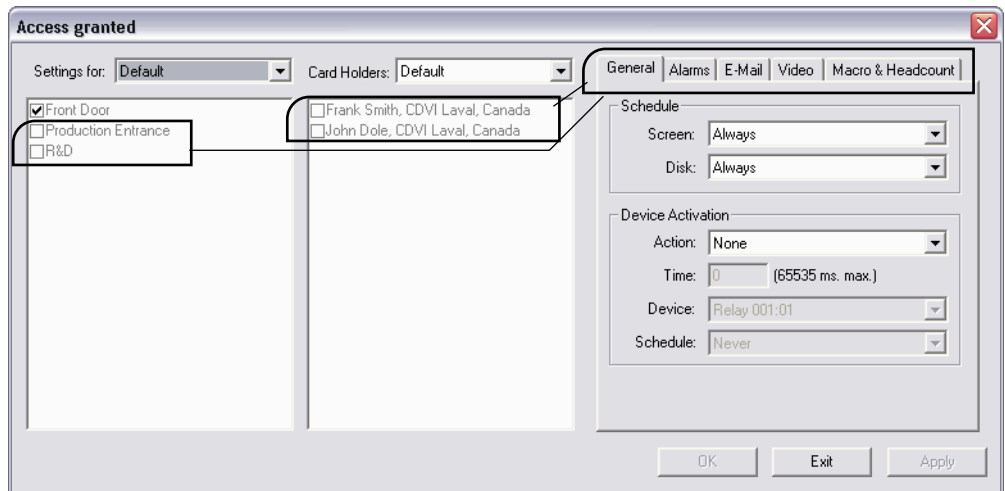

### Programming a Device-Specific Event Definition

A device-specific event definition enables you to program different settings for each device and user in the list. When you select **Devices** from the **Settings for** and/or **Card Holders** drop-down list (see step 2 in “Event Definition Overview” on page 175), the definitions that you program in the **General**, **Alarms**, **E-Mail**, **Video**, and **Macro & Headcount** tabs will apply to the highlighted devices. In this case, Front Door and John Dole.

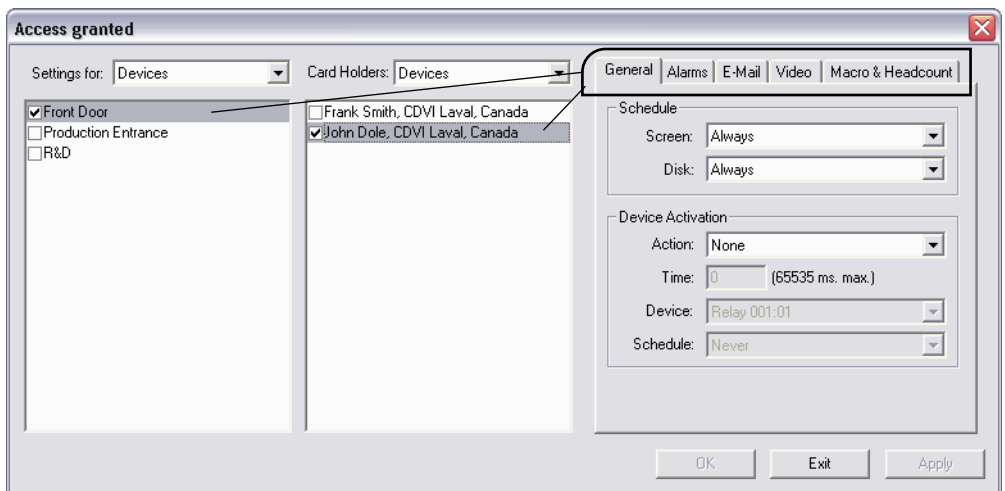

### Reset Event’s Definition to Default

To reset an event’s definition to default, right-click the desired event from the **Events** branch in the Database Tree View window and select **Reset Settings**. You can also select the desired event and press the keyboard **Delete** key.

Setting the event’s definition to default will:

- Always show the event in the Real-Time Events/Status window (see “Screen” on page 177)
- Always log the event in the Event database (see “Disk” on page 177)
- Disable alarm acknowledgement (see “Enabling Alarm Acknowledgement” on page 179)
- Disable CCTV control (see “Enabling CCTV Control for an Event” on page 182)

# CENTAUR

## Integrated Access Control V8.0

## EVENT SCHEDULES AND DEVICE ACTIVATION

Once an event has been selected as described in “Event Definition Overview”

on page 175, click the **General** tab in the event’s Properties window to program its general properties.

### Selecting the Event Schedules

Under the **Schedule** heading you can define when the selected event will be displayed in Centaur’s Real-Time Events/Status window as well as when the event will be logged in the Centaur database.

### Screen

From the **Screen** drop-down list, select the schedule that will define when the event will be displayed in the Real-Time Events/Status window. If the event occurs when the schedule is valid, the event will appear in the Real-Time Events/Status window.

### Disk

From the **Disk** drop-down list, select the schedule that will define when the event will be logged in Centaur’s databases. If the event occurs when the schedule is valid, the event will be saved.

### Selecting a Device and Setting its Properties

Under the **Device Activation** heading you can define a specific device such as a relay or output to activate or deactivate when the selected event occurs. Also, refer to the example on page 178.



**Device activation will only function when the Centaur Server is running (connected). Device activation will NOT function if the Centaur Server is offline or if the selected devices are from a remote (dial-up) site. This warning applies to the Centaur Server only. Whenever the Server comes online again, events that occurred in the last 15 minutes will activate a device. Events older than 15 minutes will be ignored upon connection.**

### Action

From the **Action** drop-down list located below the **Device Activation** heading, select the type of device or group of devices that will be activated when the event occurs. You can activate/deactivate outputs or relays, lock/unlock doors, and enable/disable door groups. Also refer to “Groups” on page 184.

### Timed

If the device selected in the **Action** drop-down list is labelled **Timed**, you can type a value from 0 to 65535 seconds in the **Timed** text field. The device will activate or deactivate for the period programmed in the **Timed** text field. If the selected device is not **Timed**, the **Timed** text field will be unavailable.

# CENTAUR

## Integrated Access Control V8.0

### Device

After selecting an **Action**, use the **Device** drop-down list to select which device or group of devices will be affected by the selected action.

### Schedule

The selected device(s) will only activate or deactivate when the schedule selected from the **Schedule** drop-down list is active. Also refer to “Schedules” on page 92.



**Example:** In “Figure 32”, any time (1) Front Door (2) is forced open (3), relay 001:03 (4B) will activate (4A) for 30 seconds (5).

Example of Activating a Device with an Event

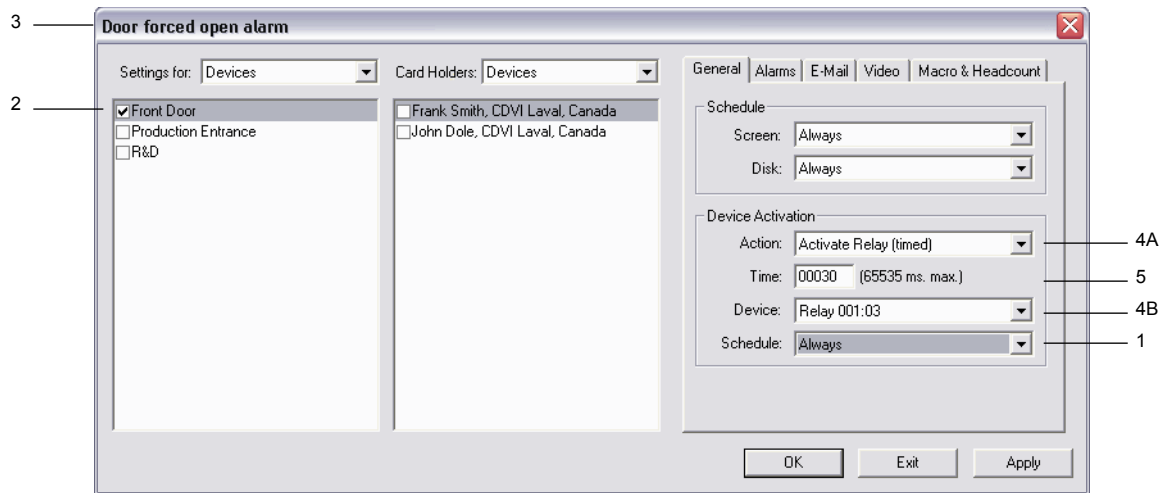

# CENTAUR

## Integrated Access Control V8.0

### ALARM ACKNOWLEDGEMENT

Alarm acknowledgement allows you to program an event to give operators a warning and/or instructions concerning the event that just occurred. These instructions will appear in the alarm acknowledgement window. The operator can then acknowledge the event and provide details concerning the event. To program an event's alarm acknowledgement properties:

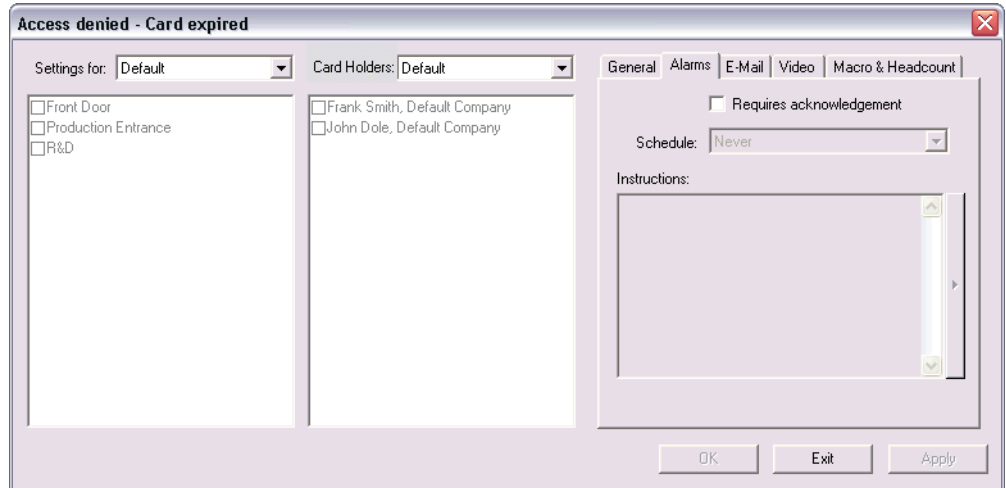

1. Select the desired event as described in “Event Definition Overview” on page 175.
2. Select the **Alarms** tab.
3. Enable the alarm acknowledgement by selecting the **Requires acknowledgement** check box. For more information, refer to “Enabling Alarm Acknowledgement” on page 179.
4. In the **Schedule** drop-down list, select the desired schedule. For more information, refer to “Selecting the Alarm Acknowledgement Schedule” on page 179.
5. Type the desired instructions and details that the operator will see on the screen into the **Instructions** text field. For more information, refer to “Typing the Instructions for the Selected Alarm” below.

#### Enabling Alarm Acknowledgement

Select the **Requires acknowledgement** check box to enable the Alarm Acknowledgement feature. If the check box is cleared the feature will be disabled and the **Schedule** drop-down list and the **Instructions** text field will be unavailable. If this feature is enabled, you can also use “Centaur Wave Player” (see page 270) to program Centaur to play a sound every time the selected event occurs.

#### Selecting the Alarm Acknowledgement Schedule

Select a schedule from the **Schedule** drop-down list. The event will only appear in the alarm acknowledgement window when the selected schedule is valid. Also refer to “Schedules” on page 92. For this feature to function, you must enable alarm acknowledgement (see “Enabling Alarm Acknowledgement” on page 179).

#### Typing the Instructions for the Selected Alarm

In the **Instructions** text field type the instructions or warnings that you wish to provide to the operator. These instructions will appear in the alarm acknowledgement window when the event occurs and the schedule is valid. For this feature to function, you must enable alarm acknowledgement (see “Enabling Alarm Acknowledgement” on page 179).

# CENTAUR

## Integrated Access Control V8.0

### Acknowledging Alarms

The following details how an operator can acknowledge an alarm.

1. If the event meets the programmed criteria (see “Alarm Acknowledgement” on page 179), the event and its programmed instructions appear in the **Alarms** window. To play a sound file every time the event occurs, refer to “Centaur Wave Player” on page 270.
2. The operator can acknowledge one event and type any comments, or the operator can acknowledge all events without providing any comments. To acknowledge one event, right-click the event in the alarm acknowledgement window and select **Acknowledge** from the list. Go to step 3. To acknowledge all events, right-click any event in the alarm acknowledgement window and select **Acknowledge all** from the list. Go to step 4.
3. The Acknowledge alarm acknowledgement window appears. Type any comments in the **Comments** text field and click **Acknowledge**.
4. The “Operator Acknowledge” event appears in the Real-Time Events/Status window. View all acknowledged events by clicking the **Acknowledged Events** icon from the tool bar. To view any recorded comments, click the **Acknowledged Events** icon, right-click the desired event in the Real-Time Events/Status window, and click **View Comments**.

# CENTAUR

## Integrated Access Control V8.0

### E-Mail Activation

After selecting an event as described in “Event Definition Overview” on page 175, click the **E-Mail** tab in the event’s properties window to program the E-Mail settings for that event.

#### Enabling Sending E-Mail for an Event

Select the **Send E-Mail** check box to send E-Mail whenever the selected event occurs. When selected, all fields become available.

The screenshot shows a dialog box titled "Access denied - Card expired" with the "E-Mail" tab selected. It features two columns of checkboxes for event locations and card holders. The "Send E-Mail" checkbox is checked, which has enabled the "Schedule" dropdown menu (set to "Never"), "To:", "Cc:", and "Bcc:" text fields, and a "Message:" text area. At the bottom, there are "OK", "Exit", and "Apply" buttons.

#### Selecting the E-Mail Schedule for an Event

Select the schedule from the **Schedule** drop-down list, which determines when Centaur can send the programmed E-Mail. If the selected schedule is not valid when the event occurs, Centaur does not send the associated E-Mail. The **Schedule** list is only available if the **Send E-Mail** check box is selected. For more information on schedules, see “Schedules” on page 92.

#### Typing the Operator E-Mail Adresse(s)

In the **To**, **Cc**, and **Bcc** text fields, type the E-Mail address(es) of the user(s) that you wish to send the E-Mail to. Only one E-mail address per field is supported.

#### Typing the Message for the Selected Event

In the **Message** text field type the content of the E-Mail message that you wish to send to the operator. This message will be sent to all the operator(s) defined in the **To**, **Cc**, and **Bcc** field E-Mail addresses when the event occurs and the schedule is valid.



*For this feature to work, Microsoft Outlook 2003 must be installed and configured on the Centaur server. Only one E-Mail per field is allowed, not possible to use; to separate E-Mail addresses.*



*If Centaur Service Manager is set as a service under Windows (see page 16), you must do the following. Click **Start**, **Control Panel**, double-click **Administrative Tools**, **Services**, and **Centaur**. From the **Centaur Properties** window, select **This account** from the **Log On** tab, enter **Administrator** for this account or any Windows administrator user, enter the Windows user’s password in the **Password** and **Confirm password** fields, click **Apply**, and click **OK**.*

# CENTAUR

## Integrated Access Control V8.0

### EVENT-ACTIVATED VIDEO CONTROL

After selecting an event as described in “Event Definition Overview” on page 175, click the **Video** tab in the event’s properties window to program the CCTV and DVR settings for that event. To activate CCTV control for a site, refer to “Site CCTV Port Settings” on page 47. To program CCTV commands, refer to “CCTV Commands” on page 204.

#### Enabling CCTV Control for an Event

Select the **Send ASCII Command** check box to send a CCTV command to the connected video switcher whenever the selected event occurs. When selected, all lists become available.

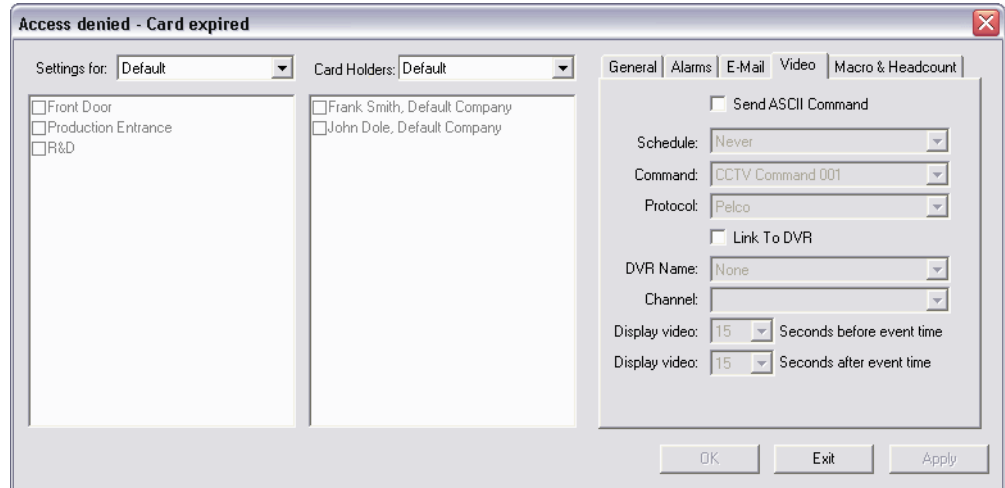

#### Selecting the CCTV Control Schedule for an Event

Select the schedule from the **Schedule** drop-down list, which determines when Centaur can send the programmed CCTV command. If the selected schedule is not valid when the event occurs, Centaur does not send the associated CCTV command. The **Schedule** list is only available if the **Send ASCII Command** check box is selected. For more information on schedules, see “Schedules” on page 92.

#### Selecting the CCTV Command for an Event

From the **Command** list select the CCTV command that you want to send to the connected video switcher whenever the selected event occurs. The **Command** list is only available if the **Send ASCII Command** check box is selected. For more information on how to program CCTV commands, refer to “CCTV Commands” on page 204.

#### Selecting the Video Switcher Protocol for an Event

From the **Protocol** list select the protocol used by the video switcher connected to the computer’s COM port (refer to “Site CCTV Port Settings” on page 47). The **Protocol** list is only available if the **Send ASCII Command** check box is selected.

#### Link to DVR

Allows the use of a DVR video when the event occurs. A camera icon will appear in front of the DVR event in the Real-Time Events/Status Window.

#### DVR Name

Select a DVR from the list you want to associate to the event. Refer to “Adding a DVR” on page 200 to add new DVR in the list.

# CENTAUR

## Integrated Access Control V8.0

### Channel

Select the DVR camera channel from the list you want to associate to the event.

### Display Video Before and After Event Time

Allows to view up to 60 seconds of video preceding and following the event. When an event occurs, the video associated to the event will contain a video length corresponding to the configured duration before and after the event.

## MACRO & HEADCOUNT

After selecting an event as described in “Event Definition Overview” on page 175, click the **Macro & Headcount** tab in the event’s properties window to program the macro and headcount settings for that event.

### Execute Macro

Select the **Execute Macro** check box to execute a macro action whenever the selected event occurs. When selected, all lists become available.

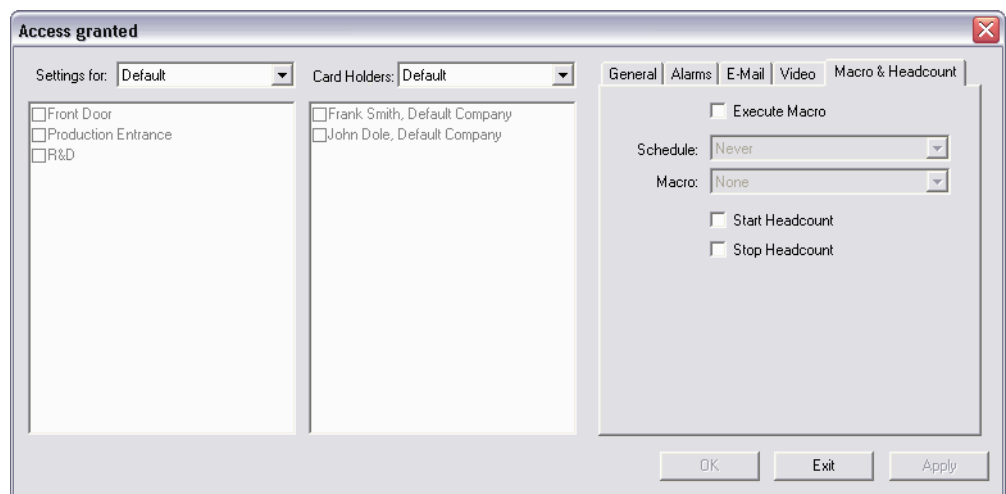

### Selecting the Macro Schedule for an Event

Select the schedule from the **Schedule** drop-down list, which determines when Centaur can execute the programmed macro. If the selected schedule is not valid when the event occurs, Centaur does not execute the associated macro. The **Schedule** list is only available if the **Execute Macro** check box is selected. For more information on schedules, see “Schedules” on page 79.

### Selecting the Macro for an Event

From the **Macro** list select the macro action that you want to execute whenever the selected event occurs. The **Macro** list is only available if the **Execute Macro** check box is selected. For more information on how to program macro actions, refer to “Macro” on page 218.

### Start Headcount and Stop Headcount

Enable start headcount by selecting the **Start Headcount** check box if you want to start the headcount process when the selected event occurs. Select the **Stop Headcount** check box to stop the headcount when the selected event occurs.

# CENTAUR

## Integrated Access Control V8.0



## Groups

### What Will I Find?

---

In the Centaur Integrated Access Control System you are often required to select one specific device (i.e. door or relay). Centaur provides you with the added option of creating a group. A group consists of more than one device. Therefore, instead of just selecting one device, you can select a group, which would represent, for example, relays 3, 4, and 5. There are eight types of groups: **Companies, Departments, Job Titles, Floors, Risk Levels, Doors, Inputs, and Relays.**

# CENTAUR

## Integrated Access Control V8.0

### WHAT ARE GROUPS?

When a card is presented to a reader programmed for elevator control, Centaur ignores the card’s assigned access levels and instead verifies the card’s assigned floor group. If the floor group’s assigned schedule (see “Selecting a Floor Group Schedule” on page 187) is valid, Centaur will allow access to the floor group’s assigned floors (see “Assigning Floors to a Floor Group” on page 186).

The door, input and relay groups enable you to create groups of devices, such as relays, that can be activated or deactivated together when a specified event occurs.

Table 1: Where are the Groups Used

GROUP TYPE	USED IN	CROSS-REFERENCE
Companies	User and Visitor Properties	“General User Properties” on page 60 and “General Visitor Properties” on page 80
Departments	User Properties	“General User Properties” on page 60
Job Titles	User Properties	“General User Properties” on page 60
Floor Groups	Card Properties	“Assigning Access to a Card” on page 142
Risk Levels	Locator	Refer to “Centaur’s Locator” online help
Door Groups	Event Definitions	“Action” on page 177
Input Groups	Input Properties	“Bypassing Inputs with an Input” on page 163
	Event Definitions	“Action” on page 177
Relay Groups	Input Properties	“Activating Relays with an Input” on page 164
	Event Definitions	“Action” on page 177

### ADDING A GROUP

In order to program a floor, door, input, or relay group, you must first program the site (see “Sites” on page 32) and the schedules (see “Schedules” on page 92). In the Database Tree View window, expand the **Groups** branch from the desired Site branch, right-click the desired type of group (**Companies, Departments, Job Titles, Floors, Risk Levels, Doors, Inputs, or Relays**), and select **New...** from the drop-down list. You can also select the desired group and press the keyboard **Insert** key. The appropriate properties window will appear (see “Modifying a Group” on page 186).



# CENTAUR

## Integrated Access Control V8.0

## MODIFYING A GROUP

From the desired Site branch in the Database Tree View window, expand the **Groups** branch, expand the desired group branch (**Companies, Departments, Job Titles, Floors, Risk Levels, Doors, Inputs, or Relays**), right-click the desired group you wish to modify, and click **Properties** from the drop-down list. You can also select the desired group and press the keyboard **Enter** key. The appropriate Properties window will appear, allowing you to configure the group.

### General Group Properties

From this window, select the appropriate **Company, Department, Floor Group, Risk Level, Door Group, Input Group, or Relay Group** tab. For **Job Titles**, there is no tab to select. This will allow you to view the site's address as well as record the group's name and any additional notes.

#### Addresses

At the top of the **Group** tab, Centaur will display the group's address, as well as the address of the site to which it belongs. The first group created is assigned "Group: 3" as its address for groups that already have the predefined **All** and **None** groups. The first group address for Floor Groups will be "Group: 1". For all other groups, the first group address will be "Group: 1". Every time a group is added, Centaur increments the group's address by one. Addresses 1 and 2 are reserved for the **All** and **None** groups.

#### Name

Use the **Name** text field in the **Group** tab to identify your groups. We recommend using a name that is representative of the group such as "Management Floor Group". Also, refer to "Typing Names and Notes" on page 30.

#### Notes

Use the **Notes** text field in the **Group** tab to record any additional notes that may be required. We recommend that you keep a log of what settings were changed and when they were changed. Also, refer to "Typing Names and Notes" on page 30.

#### Text and Background Colour (Risk Levels)

For **Risk Levels**, Centaur provides the ability to customize the text and background colour of each event logged in Locator. Use the **Text Colour** and **Background Colour** drop lists to make the selection. When an event occurs, it will appear in the Locator with its defined colours (default or custom).

### Floor Group's Floors and Schedules

From the **Floor Group Properties** window, select the **Floors** tab. This will allow you to define which floors in a site that a user has access to and when access can be granted to these floors. The floor groups are then assigned to cards in the system (see "Floor Group" on page 142). For more information on elevator control, refer to "Elevator Control" on page 146.

#### Assigning Floors to a Floor Group

All the floors that have been assigned to a site will be listed (see "Site Floor Settings" on page 46). Assign the desired floors to the floor group by selecting their associated check box.



# CENTAUR

## Integrated Access Control V8.0

### Selecting a Floor Group Schedule

Access to the floor group's assigned floors (see "Assigning Floors to a Floor Group" on page 186) will be granted when the selected schedule is valid. Select the desired schedule from the **Schedule** drop-down list. This schedule affects all floors in this floor group. Also refer to "Schedules" on page 92.

### Setting an Alternate Floor Group

If the selected schedule (see "Selecting a Floor Group Schedule" on page 187) is not valid, Centaur will verify the schedule selected as the alternate floor group. If the alternate floor group's schedule is valid, the user will have access to the floors assigned to the alternate floor group. Select the desired floor group from the **Alternate Floor Group** drop-down list.

### Assigning Devices to a Door, Input, or Relay Group

From the **Door/Input/Relay Group Properties** window, select the **Doors**, **Inputs**, or **Relays** tab. All the devices that have been programmed in the current site will be listed. Assign the desired devices to the group by selecting their associated check box.



---

**Example:** In the example below, the selected relay group has been assigned relays 3, 4, and 5 from controller 1.

---

Example of Programming a Group of Devices

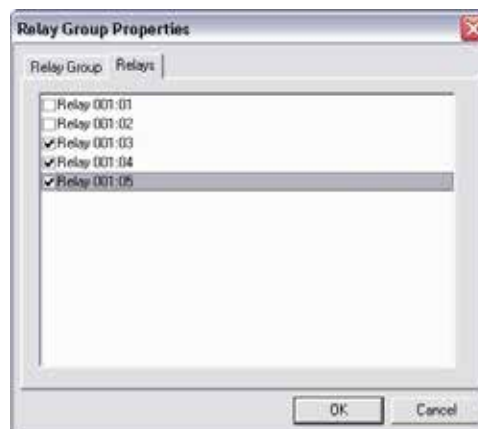

# CENTAUR

## Integrated Access Control V8.0

## ADDING DETAILS AND ASSIGNING USERS TO COMPANY AND DEPARTMENT GROUP

From the **Company/Department Group Properties** window, select the **Details** tab. Enter the company/department contact information.

From the **Company/Department Group Properties** window, select the **Users** tab. For a company group, all users and visitors defined with this company will be listed. For a department group, all users defined with this department will be listed. The list includes the first name and last name of the user or visitor and the user's group or visitor's group he belongs to.

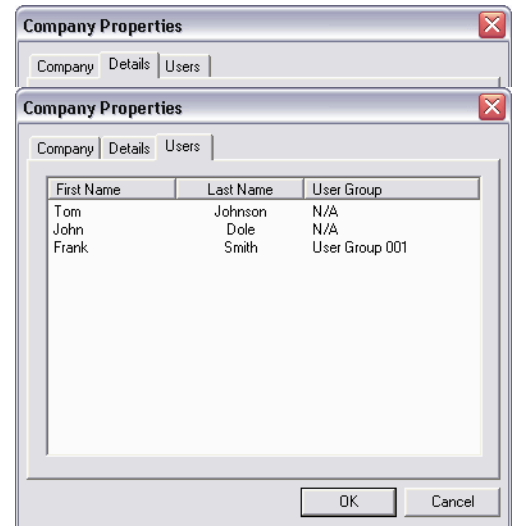

## DELETING A GROUP

From the desired Site branch in the Database Tree View window, expand the **Groups** branch, expand the desired group branch (Company, Department, Job Title, Floor, Risk Level, Door, Input, or Relay Groups), right-click the desired group you wish to delete, and click **Delete** from the drop-down list. You can also select the desired group and press the keyboard **Delete** key. A dialogue box will appear requesting confirmation.

# CENTAUR

## Integrated Access Control V8.0

## MANUAL CONTROL OF DOOR AND RELAY GROUPS

---

The following describe how you can remotely control a group of doors or relays.

### Lock or Unlock a Door Group

To lock or unlock all doors in a door group, expand the **Door Groups** branch within the Database Tree View window, right-click the desired door group and select the desired **Lock Door Group** or **Unlock Door Group** command from the drop-down list. For more information on the available commands, refer to “Displaying and Controlling the Status of a Door” on page 219.

### Enable or Disable a Door Group

To enable or disable a door group, expand the **Door Groups** branch within the Database Tree View window, right-click the desired door group, and select the desired **Enable Door Group** or **Disable Door Group** command from the drop-down list. When enabled, the door group functions normally. When disabled, the door group will be deactivated and will not be recognized by the system.

### Activate or Deactivate a Relay Group

To activate or deactivate all relays in a relay group, expand the **Relay Groups** branch within the Database Tree View window, right-click the desired relay group and select the desired **Activate Relay Group** or **Deactivate Relay Group** command from the drop-down list. When activated, each relay in the selected relay group will activate for the period specified by the relay’s activation timer (see “Setting the Relay Activation Timer” on page 140).

# CENTAUR

## Integrated Access Control V8.0



## Guard Tour

### What Will I Find?

---

The live interactive guard tour allows check point validation using card readers, input points (Motion sensors, key switches, or push buttons) or data collectors. The guard tour provides option to create and configure data collectors, check points, and rounds.

# CENTAUR

## Integrated Access Control V8.0

### ADDING DATA COLLECTORS

---

From the Database Tree View window, right-click the **Data Collectors** from the **Guard Tour** branch and click **New Data Collector**. You can also click on **Data Collectors** and press the keyboard **Insert** key. See “Modifying a Data Collector” for more information.

### MODIFYING A DATA COLLECTOR

---

From the desired Site branch in the Database Tree View window right-click the data collector you wish to modify and click **Properties** from the drop-down list. You can also select the desired data collector and press the keyboard **Enter** key.

#### Data Collector Properties

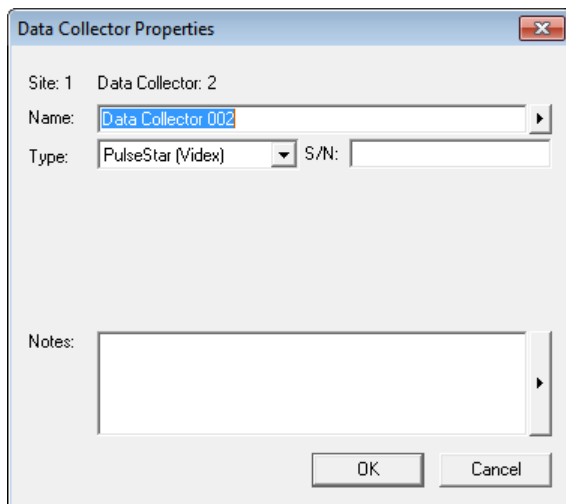

#### Name

In the data collector **Name** text field, type the desired data collector name. We recommend using a name that is representative of the data collector.

#### Type and Serial Number

Select the type of data collector and enter its serial number in the **S/N** field.

#### Notes

Use the **Notes** text field in the data collector tab to record any additional notes that may be required. Also, refer to “Typing Names and Notes” on page 30.

# CENTAUR

## Integrated Access Control V8.0

## ADDING CHECK POINTS

---

From the Database Tree View window, right-click the **Check Points** from the **Guard Tour** branch and click **New Check Point**. You can also click on **Check Points** and press the keyboard **Insert** key. See “Modifying a Check Point” for more information.

## MODIFYING A CHECK POINT

---

From the desired Site branch in the Database Tree View window right-click the check point you wish to modify and click **Properties** from the drop-down list. You can also select the desired check point and press the keyboard **Enter** key.

### Check Point

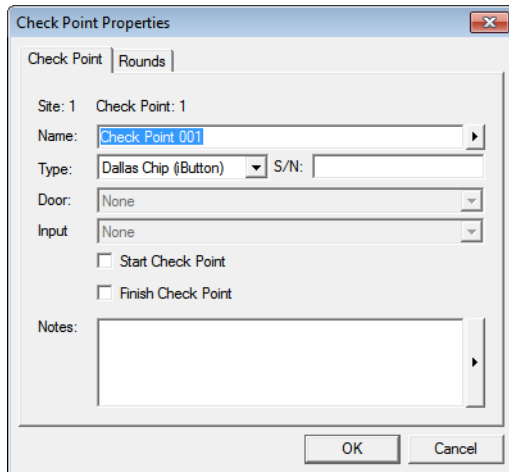

#### Name

In the check point **Name** text field, type the desired check point name. We recommend using a name that is representative of the check point.

#### Type

Select the type of check point. Choices are **Dallas Chip (iButton)**, **Input**, and **Reader**.

#### Serial Number

When the selected **Type** is **Dallas Chip (iButton)**, enter its serial number in the **S/N** field.

#### Door

When the selected **Type** is **Reader**, select the door from the list.

#### Input

When the selected **Type** is **Input**, select an input from the list.

# CENTAUR

## Integrated Access Control V8.0

### Start Check Point

Select the **Start Check Point** check box to automatically start a round when using this check point

### Finish Check Point

Select the **Finish Check Point** check box to automatically end a round when using this check point

### Notes

Use the **Notes** text field in the check point tab to record any additional notes that may be required. Also, refer to “Typing Names and Notes” on page 30.

### Rounds

Indicates the rounds using this check point. See “Round Check Points” on page 194 for more information.

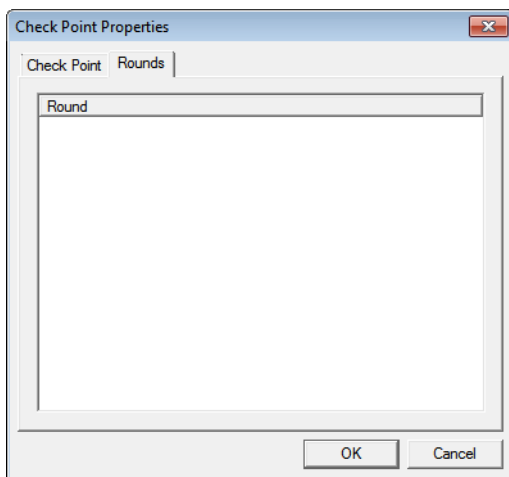

## ADDING A ROUND

From the Database Tree View window, right-click the **Rounds** from the **Guard Tour** branch and click **New Round**. You can also click on **Rounds** and press the keyboard **Insert** key. See “Modifying a Round” for more information.

## MODIFYING A ROUND

From the desired Site branch in the Database Tree View window right-click the round you wish to modify and click **Properties** from the drop-down list. You can also select the desired round and press the keyboard **Enter** key.

### Round

The screenshot shows a dialog box titled "Round" with the following elements:

- Site: 1 Round: 1
- Name: Round 001
- Schedule: Never
- Round Check Points table with columns: Check Point, Minimum Time, Maximum Time
- Notes: (empty text area)
- Buttons: +, -, ↑, ↓
- Buttons: OK, Cancel

#### Name

In the round **Name** text field, type the desired round name. We recommend using a name that is representative of the round.

#### Schedule

From the **Schedule** drop-down list, select the schedule that will determine when the round is valid. When the selected schedule is valid, the guard can start his round by going through the list of check points. For more information on schedules, refer to “Schedules” on page 92.

#### Round Check Points

Allows to set up and configure all the required check points for the round.

# CENTAUR

## Integrated Access Control V8.0

- Use the “+” sign to add a new check point to the list.

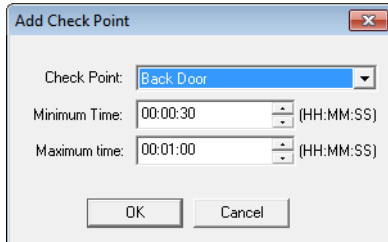

The screenshot shows a dialog box titled "Add Check Point". It features a dropdown menu for "Check Point:" with "Back Door" selected. Below this are two time input fields: "Minimum Time:" with the value "00:00:30" and "Maximum time:" with the value "00:01:00". Both time fields include up and down arrows and "(HH:MM:SS)" labels. At the bottom of the dialog are "OK" and "Cancel" buttons.

- Use the “-” sign to remove the selected check point from the list.
- Use the up or down arrow to move the selected check point into the list.

### Notes

Use the **Notes** text field in the check point tab to record any additional notes that may be required. Also, refer to “Typing Names and Notes” on page 30.

# CENTAUR

## Integrated Access Control V8.0



## Operators

### What Will I Find?

---

Operators are personnel authorized to program and/or monitor the Centaur Integrated Access Control System through the Centaur software. Each operator authorized to access the Centaur system can be defined with different permissions and security levels. Security levels determine whether an operator can view, modify, and/or delete system characteristics. The system characteristics consist of all the elements found in the Database Tree View window such as controllers, doors, and events. After creating a security level, the security level is assigned to a permission, and the permission is assigned to an operator.

# CENTAUR

## Integrated Access Control V8.0

### OVERVIEW OF OPERATORS

Operators are personnel authorized to interact with the Centaur Integrated Access Control System through the Centaur software. Each operator can be defined with different permissions and security levels. To create an operator you must set up the following items in the order specified below:

- **Security levels** determine whether an operator can view, modify, and/or delete system characteristics and whether the operator can perform manual controls, such as locking and unlocking doors remotely. The system characteristics consist of all the elements found in the Database Tree View window, such as controllers, doors, and events. For more information, refer to “Security Levels” on page 199. Security levels are then assigned to a permission.
- **Permissions** determine which sites the operator is authorized to access and the operator’s security level for each site. For more information, refer to “Permissions” on page 200. Permissions are then assigned to an operator.
- **Operators** determine who can access the Centaur software to program and monitor the integrated access control system. Define the login ID and password, assign a permission and select which software modules will be accessible. For more information, refer to “Operators” on page 196.

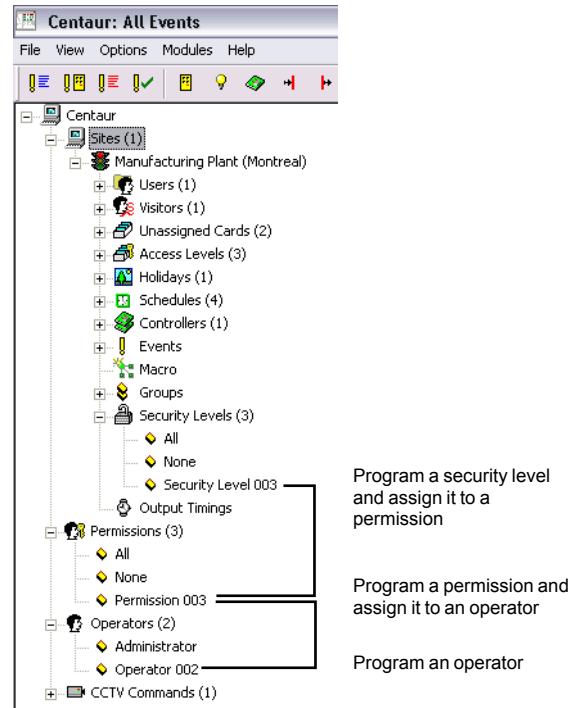

Centaur includes two default security levels and two default permissions (**All** and **None**), which cannot be modified or deleted. The **All** security level and permission enable you to program, view and delete any system characteristic. The **None** security level and permission will deny any access to all system characteristics. Unlike security levels, the permissions are not programmed per site; instead, they apply to the entire integrated access control system.

Centaur includes one default operator (**Administrator**), which cannot be modified (except for its logon ID and password) or deleted. The **Administrator** has full access to all system characteristics in all sites.

### ADDING A SECURITY LEVEL, PERMISSION, OR OPERATOR

To add a security level or a permission, right-click **Permissions** in the Database Tree View window or right-click **Security Levels** from the desired Site branch in the Database Tree View window. Select **New Permission** or **New Security Level** from the drop-down list. You can also select **Permissions** or **Security Levels** and press the keyboard **Insert** key.

To add an operator, right-click **Operators** in the Database Tree View window and select **New Operator** from the drop-down list. You can also select **Operators** and press the keyboard **Insert** key.

After adding a security level, permission, or operator, the appropriate Properties window will appear (see “Modifying a Security Level, Permission, or Operator” on page 198), allowing you to configure the selected item.

# CENTAUR

## Integrated Access Control V8.0

### MODIFYING A SECURITY LEVEL, PERMISSION, OR OPERATOR

To modify a security level or permission, right-click the security level or permission you wish to modify and click **Properties** from the drop-down list. You can also select the security level or permission you wish to modify and press the keyboard **Enter** key. You cannot modify the default **All** and **None** security levels and permissions.

To modify an operator, right-click the operator you wish to modify from the Database Tree View window and click **Properties** from the drop-down list. You can also select the desired operator and press the keyboard **Enter** key. You cannot modify the default **Administrator**.

#### General Properties for Security Levels, Permissions, and Operators

From this window, select the **Security Level**, **Permission**, or **Operator** tab. This will allow you to view some of the system's component addresses as well record the name and any additional notes.

#### Viewing the Security Level, Permission, or Operator's Address

At the top of the **Security Level** tab, Centaur will display the selected site's address, as well as the address of the selected security level. The first security level created is assigned "Security Level: 3" as its address. Every time a security level is added, Centaur increments the item's address by one. Addresses 1 and 2 are reserved for the **All** and **None** security levels.

At the top of the **Permission** and **Operator** tab, Centaur displays the address of the selected permission or operator. The first permission created is assigned "Permission: 3" as its address and the first operator created is assigned "Operator: 3" as its address. Every time a permission or operator is added, Centaur increments the item's address by one. Permission addresses 1 and 2 are reserved for the **All** and **None** permissions and operator address 1 is reserved for the **Administrator** operator.

#### Typing the Security Level, Permission, or Operator's Name

In the **Name** text field, type a descriptive name for the security level (e.g. Level 1), permission (e.g. System Master), or operator (e.g. John Doe). Also refer to "Typing Names and Notes" on page 30.

#### Typing the Security Level, Permission, or Operator's Notes

In the **Notes** text field type any important explanations of the selected item and its use. Also refer to "Typing Names and Notes" on page 30.

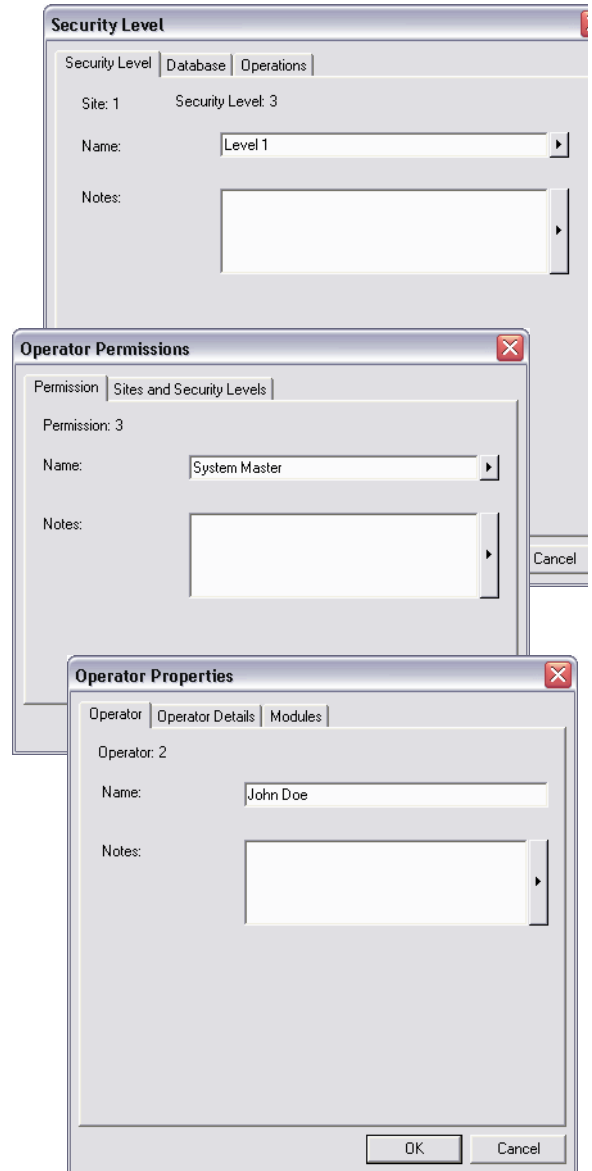

# CENTAUR

## Integrated Access Control V8.0

### Security Levels

Security levels determine whether an operator can view, modify, and/or delete system characteristics and whether the operator can perform manual controls, such as locking and unlocking doors remotely. The system characteristics consist of all the elements found in the Database Tree View window, such as controllers, doors, and events. Security levels are then assigned to permissions (see “Permissions” on page 200).

#### Setting the Security Level’s Programming Rights

From the **Security Level** properties window, select the **Database** tab programmed, and/or deleted for the selected site. The system characteristics consist of all the elements found in the Database Tree View window, such as access levels, cards, and controllers. Each system characteristic has three check boxes labeled **View**, **Modify**, and **Delete**, which are detailed below.

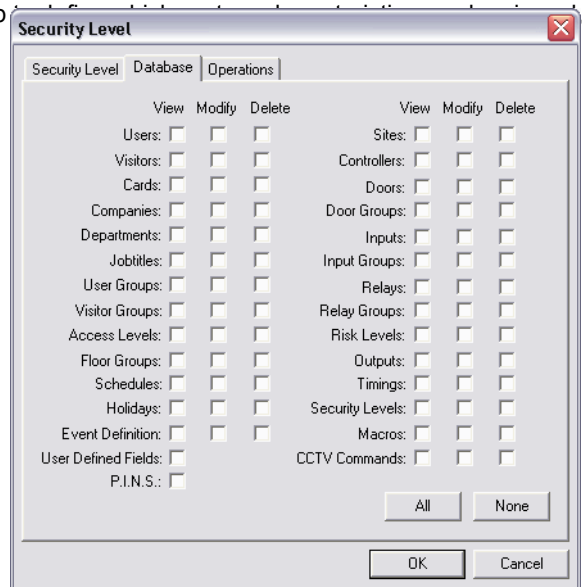

#### View

If you select the **View** check box, the operator assigned with this security level will be able to view the details of the associated characteristic. For example, if the **View** check box located next to **Access Levels** is selected, the operator assigned with this security level will be able to view all the programmed access levels in the site.

#### Modify

If you select the **Modify** check box, the operator assigned with this security level will be able to view, add, and edit any elements of the associated characteristic. For example, if the **Edit** check box located next to **Controllers** is selected, the operator assigned with this security level will be able to view, add, and edit the site’s controllers.

#### Delete

If you select the **Delete** check box, the operator assigned with this security level will be able to view and delete elements of the associated characteristic. For example, if the **Delete** check box located next to **Cards** is selected, the operator assigned with this security level will be able to view and delete any of the site’s cards.

#### All

Click the **All** button to select all the **View**, **Modify**, and **Delete** check boxes of every system characteristic.

#### None

Click the **None** button to clear all the **View**, **Modify**, and **Delete** check boxes of every system characteristic.

# CENTAUR

## Integrated Access Control V8.0

### Setting the Security Level's Manual Operation

From the **Security Level** properties window, select the **Operations** tab to define which manual actions (see "Manual Controls" on page 246) that the operator can perform. You can also define whether an operator can acknowledge alarms and whether they can acknowledge all alarms (see "Alarm Acknowledgement" on page 179). To allow operators to perform actions detailed above, select the check box associated with the desired operation.

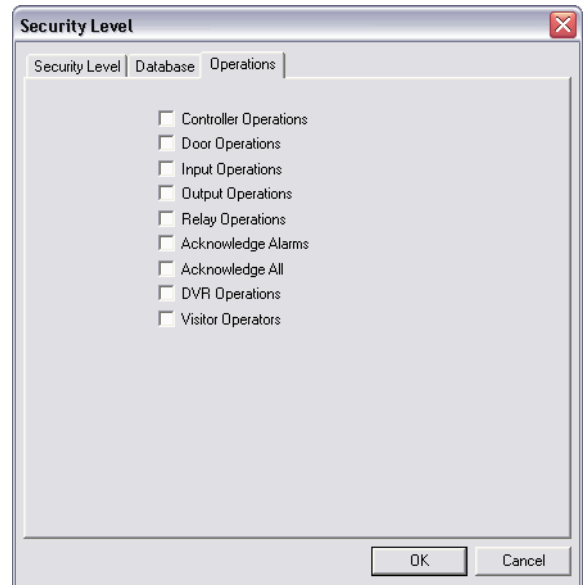

### Permissions

Permissions determine which sites the operator is authorized to access and the operator's security level for each site. Permissions are then assigned to operators (see "Operators" on page 201).

### Assigning Security Levels to a Permission

Each site in the permission can be assigned with a different security level.

1. From the **Operator Permissions** properties window, select the **Sites and Security Levels** tab. A list of all sites that have been created will appear with a check box on the left of each one.
2. To assign a site to the permission, select the check box associated with the desired site. The **Security Level** drop-down list will become active.
3. From the **Security Level** drop-down list, select the security level you would like to assign to the selected site. When a site is selected, only security levels created for that site will appear in the drop-down list. Although there is only one **Security Level** drop-down list, you can assign a different security level to each selected site. The selected security level will be assigned to the highlighted site whose check box is selected.
4. Return to step 2 to assign another site and security level or click **OK** to save and exit.

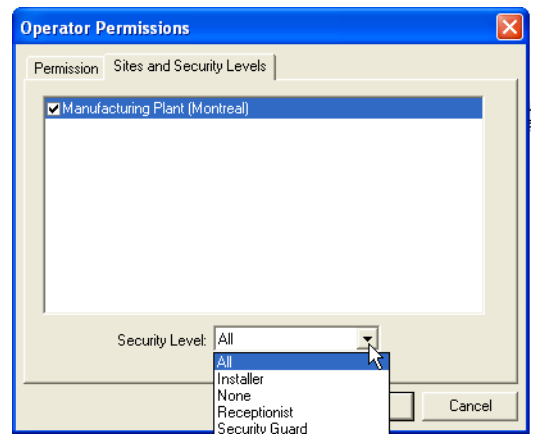

# CENTAUR

## Integrated Access Control V8.0

### Operators

Operators enable you to determine which personnel are authorized to program, control, and/or monitor the Centaur Integrated Access Control System through the Centaur software. Define the login ID and password, assign a permission, and select which software modules will be accessible for each operator.

#### Setting the Operator's Access Rights

Perform the following to define the operator's system privileges:

1. From the Operator Properties window, select the **Operator Details** tab.
2. In the **Logon ID** text field, under **Centaur Settings**, type the operator's user name that will be used when logging on to the Centaur server (see "Starting the Centaur Server and Software" on page 18).
3. In the **Password** text field, under **Centaur Settings**, type the password that the operator will use when logging on to the Centaur server (see "Starting the Centaur Server and Software" on page 18).
4. In the **Confirm Password** text field, under **Centaur Settings**, retype the **Password** text field to confirm the use of that password.
5. Select the permission you wish to assign to the operator from the **Permissions** drop-down list, under **Centaur Settings**. This determines which system characteristics can be viewed, modified, and/or deleted, and which manual controls can be performed. Also refer to "Permissions" (see page 200).
6. In the **DVR** drop-down list, under **DVR Settings**, select a DVR from the list. DVRs must be created first from the **Available DVR's** window on page 213
7. In the **Logon ID** text field, under **DVR Settings**, type the name configured in the DVR device that will be used when viewing live video (see "Display Live Video" on page 217) or when searching for video (see "Show Archived Video" on page 215).
8. In the **Password** text field, under **DVR Settings**, type the password configured in the DVR device that the operator will use when viewing live video (see "Display Live Video" on page 217) or when searching for video (see "Show Archived Video" on page 215).
9. In the **Confirm Password** text field, under **DVR Settings**, retype the **Password** to confirm the user password.
10. Click **OK**.

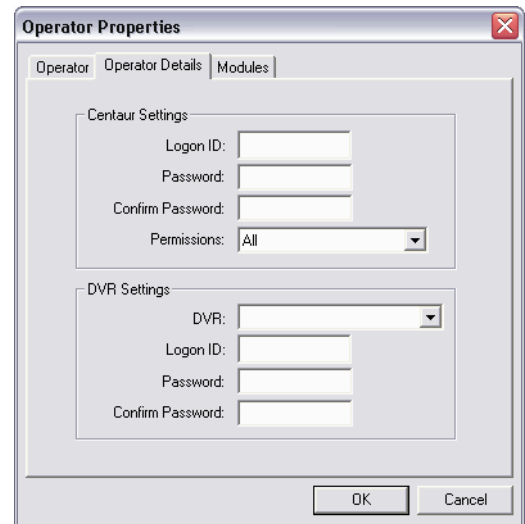

# CENTAUR

## Integrated Access Control V8.0

### Assigning Which Software Applications Operators Can Use

All of the software applications listed below are automatically installed with the Centaur software. Perform the following to enable an operator to use one or more of the software modules automatically installed with Centaur:

1. From the **Operator Properties** window, select the **Modules** tab.
2. Select the check box(es) associated with the desired software module(s) to enable the operator to use the selected software module(s).
3. Click **OK**.

#### *FrontDesk (User Management)*

Centaur's FrontDesk provides an easy to use interface to program the user properties and includes an advanced search engine. For more information, refer to "FrontDesk" on page 75

#### *User & Card Import/Export*

Centaur's user and card import/export feature (server only) enables you to export Centaur user and card data to a .csv file or import a .csv file containing user and card data into Centaur's card database.

#### *Database Management*

Centaur's database file management feature (server only) allows you to control and manage the often large and complex database files of the Centaur software. You can back up and restore database files, purge events from selected sites during specific periods, limit the size of database files and delete entire database files. For more information, refer to "Database Management" on page 258.

#### *Database Backup Scheduler*

Centaur's database backup scheduler (server only) enables you to schedule regular backups of the Centaur databases. You can back up the Main database and the Event database separately, specify the location of the backup files and select how often (daily, weekly, or monthly) the backup will occur. For more information, refer to "Database Backup Scheduler" on page 267.

#### *Front Guard (Visual Authentication)*

Centaur's visual authentication feature uses events generated in Centaur to retrieve a picture and/or video feed to help you identify users or to view the location where an event has occurred. For more information, refer to Centaur's Visual Authentication Software *Operator's Manual*.

#### *Locator (User Location)*

Designed to function with the system's Global Anti-Passback feature, Centaur's Anti-Passback Monitoring feature allows you to monitor when users enter and exit designated doors in real-time, retrieve user/card information and print customizable user/card access reports. For more information, refer to Centaur's *Anti-Passback Monitoring Software Online Help*.



# CENTAUR

## Integrated Access Control V8.0

### *WavePlayer (Event Driven Sounds Player)*

This utility was designed to enable a .wav file to be played on the computer when an event that requires acknowledgement occurs. The sound can replay at programmed intervals until the alarm is acknowledged. For more information, refer to “Centaur Wave Player” on page 270.

### *Pro-Report (Report Generation)*

Centaur’s Report Generation feature provides a user-friendly wizard for generating system and Time and Attendance reports. Generate quick (one-time), pre-defined and scheduled reports for up to 8 different report types. You can also search, group, and sort your reports. For more information, refer to Centaur’s *Report Generation Software Operator’s Manual*.

### *Tracker (Time & Attendance)*

When the **Tracker (Time & Attendance)** check box is selected, the time and attendance from the punch device become available for the Pro-Report module. For more information, refer to Centaur’s *Report Generation Software Operator’s Manual*.

### *FrontView (Real Time Graphic)*

Centaur’s real-time graphic interface gives you point-and-click control over doors, relays, inputs, outputs, and controllers through a graphical floor plan. For more information, refer to Centaur’s *Real-Time Graphic Interface Online Help*.

### *Centaur Service Manager*

The Centaur Service Manager allows operators to start and access the Centaur Integrated Access Control System. A valid operator login ID and password are required to start Centaur. For more information on how to use the Centaur Service Manager, refer to “Starting the Centaur Server and Software” on page 18.

### *Diagnostic Tool*

Centaur’s new Diagnostic Tool allows you to view your system information to ensure all of the components required to run the Centaur software have been installed. Within the Diagnostic Tool’s menu, you may save or copy your system information to a specific folder on your computer or send it directly to our technical support team in the event that you require assistance. This tool is also helpful in assessing which prerequisites your computer may require when upgrading to the latest version of the Centaur software.

### *Badge Editor*

When the **Badge Editor** check box is selected, the badge designer become available for the **User Properties** window allowing to design and print user badges. For more information, refer to “Badge” on page 63.

## **DELETING A SECURITY LEVEL, PERMISSION, OR OPERATOR**

---

To delete a security level or permission, right-click the security level or permission you wish to delete and click **Delete** from the drop-down list. You can also select the desired security level or permission and press the keyboard **Delete** key. A dialogue box appears requesting confirmation. You cannot delete the default **All** and **None** security levels and permissions.

To delete an operator, right-click the desired operator from the Database Tree View window and click **Delete** from the drop-down list. You can also select the desired operator and press the keyboard **Delete** key. A dialogue box appears requesting confirmation. You cannot delete the default **Administrator**.

# CENTAUR

## Integrated Access Control V8.0



## CCTV Commands

### What Will I Find?

---

When you activate CCTV control, Centaur can send a detailed CCTV command to a video switcher whenever an event assigned with that command occurs. The CCTV command will tell the video switcher to switch to a specific camera and monitor. You can even set the cameras to tilt, pan, and/or zoom.

Prior to assigning CCTV Commands to an event (refer to "Event-Activated Video Control" on page 182), you must program the CCTV commands, which will define how the video switcher will react when selected system events occur.

# CENTAUR

## Integrated Access Control V8.0

### ADDING A CCTV COMMAND

Right-click the **CCTV Commands** branch in the Database Tree View window and select **New CCTV Command** from the drop-down list. You can also select **CCTV Commands** and press the keyboard **Insert** key. The CCTV Command Properties window will appear (see “Modifying a CCTV Command”), allowing you to configure the CCTV Command.

### MODIFYING A CCTV COMMAND

Right-click the desired CCTV Command from the **CCTV Commands** branch in the Database Tree View window and select **Properties** from the drop-down list. You can also select the desired CCTV Command from the **CCTV Commands** branch in the Database Tree View window and press the keyboard **Enter** key. The CCTV Command Properties window will appear, allowing you to configure the CCTV Command.



#### General CCTV Command Properties

From the **CCTV Command Properties** window, select the **General** tab to record the CCTV Command’s name and any additional notes.

##### Typing a CCTV Command’s Name

Use the **Name** text field in the **General** tab to identify the CCTV Command. We recommend using a name that is representative of the CCTV Command such as “Cam1 Vid3”. Also, refer to “Typing Names and Notes” on page 30.

##### Typing a CCTV Command’s Notes

Use the **Notes** text field in the **General** tab to record any additional notes that may be required. We recommend that you keep a log of what settings were changed and when they were changed. Also, refer to “Typing Names and Notes” on page 30.

#### CCTV Command Settings

A CCTV Command and its programmed settings are assigned to one or more system event (refer to “Selecting the CCTV Command for an Event” on page 182) and when that event occurs within its assigned schedule (refer to “Selecting the CCTV Control Schedule for an Event” on page 182), Centaur sends the assigned command to the video switcher connected to the COM port selected in the site properties (refer to “Selecting a Computer COM Port for CCTV” on page 48).

# CENTAUR

## Integrated Access Control V8.0

### Defining a CCTV Command

Perform the following to program a CCTV Command's settings:

1. From the **CCTV Command Properties** window, select the **Details** tab.
2. If you want to use the preset CCTV commands offered by Centaur, follow step 3 to step 6. If you want to send a CCTV command that is not offered by Centaur, select the **Custom Command** check box, type the desired command in the text field below the check box and go to step 6. When you select the **Custom Command** check box, all other options are disabled.
3. From the **Select Preset** drop-down list, select one of the video switcher's preset definitions to be activated when the selected event occurs. When you select a preset definition, the radio buttons under the **Tilt**, **Pan**, and **Zoom** headings are unavailable. If you do not want to use a preset definition, select **None** and use the radio buttons under the **Tilt**, **Pan**, and **Zoom** headings to select the tilt, pan, and zoom commands you wish to send to the video switcher's camera selected in the next step.
4. From the **Select Camera** drop-down list, select which camera will be activated when the selected event occurs.
5. From the **Select Monitor** drop-down list, select which monitor will be activated when the selected event occurs.
6. Click **OK**.



## DELETING A CCTV COMMAND

Right-click the desired CCTV Command from the **CCTV Commands** branch in the Database Tree View window and select **Delete** from the drop-down list. You can also select the desired CCTV Command from the **CCTV Commands** branch in the Database Tree View window and press the keyboard **Delete** key. A dialogue box appears requesting confirmation.

# CENTAUR

Integrated Access Control V8.0

# CENTAUR

## Integrated Access Control V8.0



## Assets

### What Will I Find?

---

Each asset can be defined using a name and a picture, and then be assigned to a user.

# CENTAUR

## Integrated Access Control V8.0

## ADDING AN ASSET

---

In the Database Tree View window, right-click **Assets** from the desired Site branch and click **New Asset**. You can also select **Assets** and press the keyboard **Insert** key. The asset properties window will appear, allowing you to configure the asset properties. See “Modifying an Asset” for more information.

## MODIFYING AN ASSET

---

From the desired Site branch in the Database Tree View window, right-click the asset you wish to modify and click **Properties** from the drop-down list. You can also select the desired asset and press the keyboard **Enter** key.

### Asset Properties

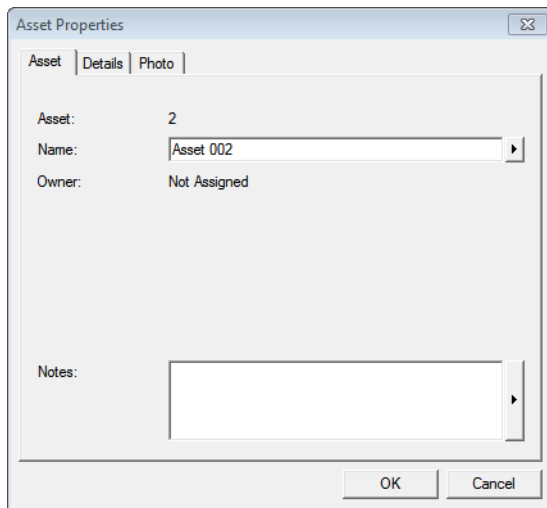

The screenshot shows the 'Asset Properties' dialog box with the 'Asset' tab selected. The 'Asset' field contains the value '2'. The 'Name' field contains 'Asset 002'. The 'Owner' field contains 'Not Assigned'. There is a 'Notes' text area at the bottom. The 'OK' and 'Cancel' buttons are at the bottom right.

#### Name

In the asset **Name** text field, type the desired asset name. We recommend using a name that is representative of the asset.

#### Owner

Indicates either the name of the owner of this asset or **Not Assigned** when the asset is not assigned. To assign an asset to a user/visitor, refer to “Assets” on page 71.

#### Notes

Use the **Notes** text field in the **Asset** tab to record any additional notes that may be required. Also, refer to “Typing Names and Notes” on page 30

#### Details

This tab is not supported.

# CENTAUR

## Integrated Access Control V8.0

### Photo

You can associate a picture to an asset. Use one of the following methods to associate a picture to the asset.

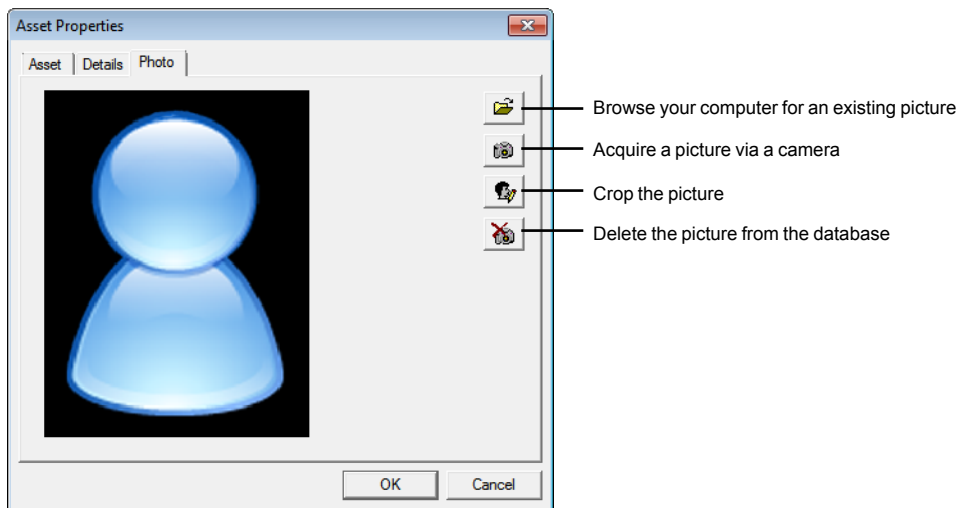

***Browse your computer for an existing picture***

Allows selecting a picture on disk. Click on this button and select the picture file and click on **Open**.

***Acquire a picture via the camera***

Allows acquiring a picture from a camera or a scanner. Click on this button and select either **Video (Direct Show)** or **Scan (Twain)**.

***Crop the picture***

Allows cropping the picture proportionally. Click on this button and click-and-drag the appropriate corner(s) to reduce the picture.

***Delete the picture from the database***

Allows removing the user's picture from the database. Click on this button to remove the user's picture and replace it by the default picture.

## DELETING AN ASSET

---

In the Database Tree View window, right-click the desired asset and click **Delete** from the drop-down list. You can also select the desired asset and press the keyboard **Delete** key. A dialogue box will appear requesting confirmation.

# CENTAUR

Integrated Access Control V8.0

# CENTAUR

## Integrated Access Control V8.0



## DVR

### What Will I Find?

This section allows to add and configure DVR settings. It also covers how to access archive or live video and how to use the search video feature.

# CENTAUR

## Integrated Access Control V8.0

### ACCESSING THE AVAILABLE DVRS

From the Centaur toolbar, click on the **Display DVR Setting** icon. The available DVR's window will appear listing all configured DVR for this site. Each DVR will be listed with the following information: **Name**, **Description**, **Manufacturer**, **Channels**, **IP Address**, **Port**, **Search Port**, and **Database Path**.

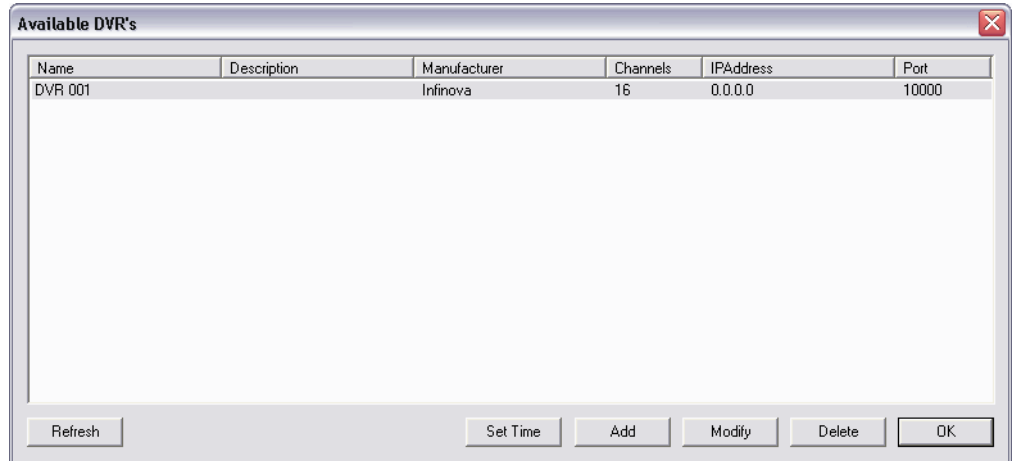

### Adding a DVR

From the available DVR's window, click on the **Add** button. The DVR settings window will appear (see "Modifying DVR Settings"), allowing you to configure the DVR settings.

### Modifying DVR Settings

To modify the DVR settings, from the **Available DVR's** window, select a DVR from the list by clicking on it then click on the **Modify** button.

#### Name

Use the **Name** text field to identify the DVR. We recommend using a name that is representative of the DVR such as "Cam1 Vid3". Also, refer to "Typing Names and Notes" on page 30

#### Description

Use the **Description** text field to record a description for the DVR. Also, refer to "Typing Names and Notes" on page 30.

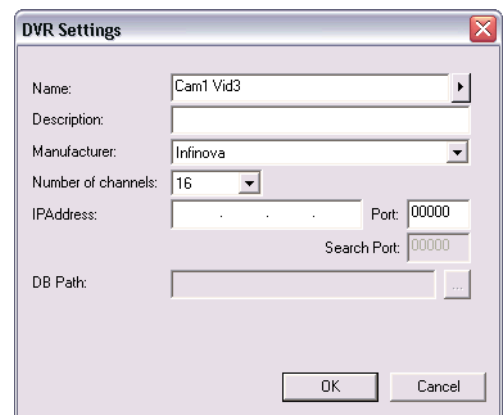

# CENTAUR

## Integrated Access Control V8.0

### Manufacturer

From the **Manufacturer** drop list, select the DVR manufacturer name corresponding to the physical DVR device. Centaur supports the following manufacturers:

- *Capture*
- *Dahua*
- *Dedicated Micros*
- *Digiop*
- *Digital WatchDog*
- *Eneo*
- *Everfocus*
- *HIK Vision*
- *Infinova*
- *Microcom*
- *Milestone*
- *NUUO*
- *Samsung*
- *Sphere*
- *ViewGate*
- *Vivotek IP Camera*
- *Vivotek*



---

Consult our website at [www.cdvi.ca](http://www.cdvi.ca) for the complete list of supported DVR.

---

### Number of channels

Select the number of channel available on the selected DVR. Choices are from 1 to 64.

### IP Address, Port, and Search Port

From the **IP Address** field enter the IP address of the DVR, from the **Port** field enter its port number, and from the **Search Port** field enter the port number that will be used to search for the specified IP address.

### DB Path

When **Vivotek IP Camera** is selected as the **Manufacturer**, select the folder where the Vivotek database is located.

### Refresh

The refresh button is used to refresh the list of available DVRs. This may be useful when somebody from another workstation did some modifications recently.

### Set Time

The **Set Time** button allows to manually set the time of the DVR. Click the **Set Time** button to establish the communication with the DVR. Once the communication is established, enter the new time.

# CENTAUR Integrated Access Control V8.0

## Deleting a DVR

From the **Available DVR's** window, select a DVR from the list by clicking on it then click on the **Delete** button. A dialogue box appears requesting confirmation.

## VIEWING ARCHIVED OR LIVE VIDEO

When an event defined to use DVR occurred (refer to "Link to DVR" on page 182), an event is added to the Real-Time Events/Status Window. A camera icon to the left of the event name indicates that this event is a DVR video capture event.

Right-click on the camera icon and select either **Show Archived Video** (see "Show Archived Video" on page 216) to watch recorded video or **Show Live Video** (see "Display Live Video" on page 217) to watch a live video.

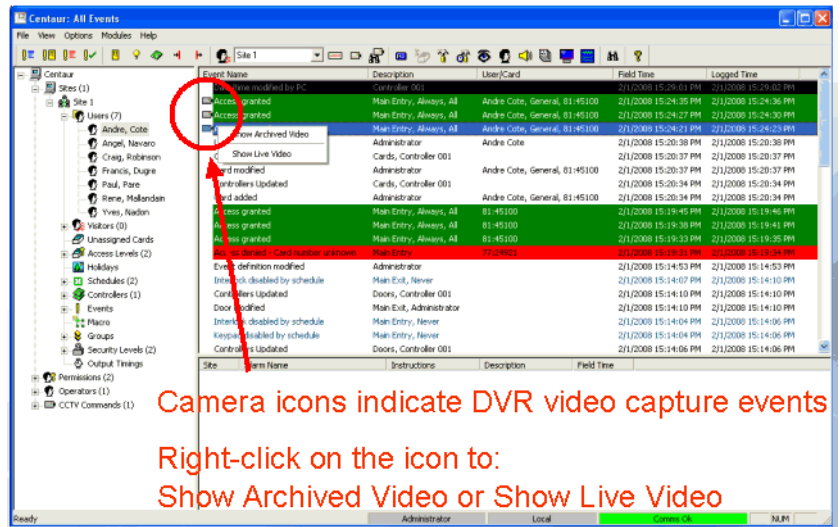

# CENTAUR

## Integrated Access Control V8.0

### SHOW ARCHIVED VIDEO

The Centaur DVR allows to watch a saved/archived video.

To watch an archive video, click on the **Display Archived Video** icon from the Centaur toolbar.

If more than one video is available, a window is displayed allowing you to choose the desired DVR. Select the DVR and click OK.

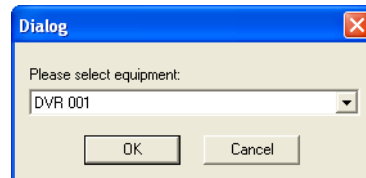

The DVR Video Display window appears.

The **DVR Name** displays the DVR selected.

#### Selecting an Archived Video

For an archived video, select the start and end time for the video you want to search for.

Note that the end time is only available when the DVR is supporting the end time feature.

#### Using DVR Command Buttons

The DVR command buttons, at the bottom of the DVR Video Display window, allows to respectively play video, play video frame by frame, pause, stop, and capture frame. Capture frame is only available when the DVR is supporting this feature.

#### Capturing and Saving a Frame

To capture a frame, press the frame capture button.

To save the captured frame, select the **Picture Folder** and file name, then press **OK**.



# CENTAUR

## Integrated Access Control V8.0

### DISPLAY LIVE VIDEO

The Centaur DVR allows to watch a live video from a specific camera.

To watch a live video, click on the **Display Live Video** icon from the Centaur toolbar.

If more than one video is available, a window is displayed allowing you to choose the desired DVR. Select the DVR and click OK.

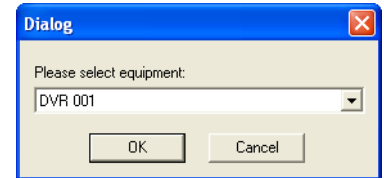

The DVR Video Display window appears.

The **DVR Name** displays the DVR selected.

Select the **Channel** of the selected DVR and the live video will automatically be displayed.

Press **OK** to close the DVR Video Display window.



# CENTAUR

## Integrated Access Control V8.0



## Macro

### What Will I Find?

---

Macro is used to send actions (up to 16) to a device whenever an event assigned with that macro occurs. The macro will tell the device to do specified actions like **Activate Relay (timed)**, **Lock Door**, etc. Centaur must be running to be able to use the macro's functionalities.

# CENTAUR

## Integrated Access Control V8.0

## ADDING A MACRO

In the Database Tree View window, right-click **Macro** from the desired Site branch, and click on **New Macro**. The macro properties window will appear (see “Modifying Macro Settings”), allowing you to configure the macro settings.

## MODIFYING MACRO SETTINGS

To modify a macro, right-click the macro you wish to modify and click **Properties** from the drop-down list.

### General Macro Properties

From the **Macro Properties** window, select the **Macro** tab. This will allow you to view some of the system component addresses as well as record the macro name and any additional notes.

#### Typing a Macro Name

Use the **Name** text field to identify the macro. We recommend using a name that is representative of the macro. Also, refer to “Typing Names and Notes” on page 30.

#### Typing the Macro Notes

In the **Notes** text box, record any important explanations of the macro and its use. Try to keep an up-to-date record of where the macro is used. This will help you understand how changing the macro will affect the system. Also, refer to “Typing Names and Notes” on page 30.

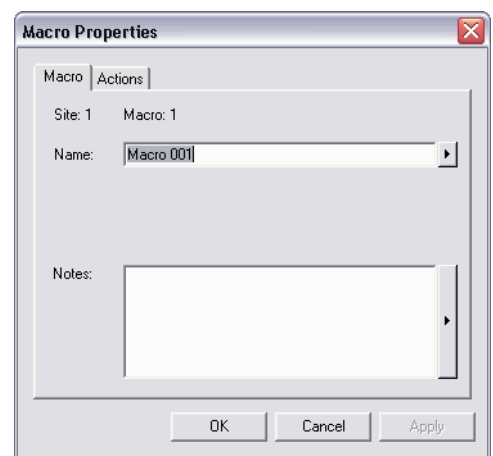

### Defining the Macro Actions

From the **Macro Properties** window, select the **Actions** tab. This will allow you to add, delete, modify the action(s).

Up to 16 actions can be created. All actions will be executed at the same time, no order.

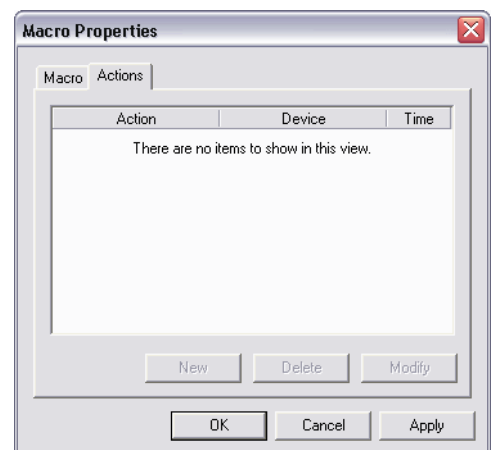

# CENTAUR

## Integrated Access Control V8.0

### Adding a New Action

Click on the **New** button to add a new action.  
Select the macro action parameters and click **OK**.

#### *Action*

Select the macro action from the **Action** drop list.

#### *Time*

Select how long (0 to 65535 ms) the action will be effective. The **Time** field is only available with action name ending with **(timed)** like **Activate Relay (timed)**.

#### *Device*

Select the device on which the selected action will take effect.

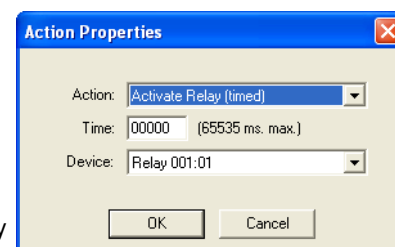

### Deleting an Action

To delete an Action, click on the desired action from the list and click on the Delete button.

### Modifying an Action

To modify an Action, click on the desired action from the list and click on the Modify button. See "Adding a New Action" above for more information.

## DELETING A MACRO

---

To delete an existing macro, right-click the macro and click **Delete**. You can also click the desired macro and press the keyboard **Delete** key. A dialogue box will appear requesting confirmation. You cannot delete a macro assigned/used in other parts of the system such as event definition.

# CENTAUR

Integrated Access Control V8.0

# CENTAUR

## Integrated Access Control V8.0



## Options

### What Will I Find?

The Centaur software can be programmed to provide visual and/or auditory feedback when specific events or alarms occur in the system. You can also determine at what frequency (in seconds) that Centaur will update the Real-Time Events/Status window. The colours of each event that appear in the Real-Time Events/Status window can be customized to your needs. You can also set the Centaur administration consoles to automatically log off if no action has occurred after a specified amount of time.

# CENTAUR

## Integrated Access Control V8.0

### GENERAL CENTAUR OPTIONS

From Centaur's main menu bar, select the **Options** menu and select **Options** from the drop-down list. The **Options** window will appear, allowing you to set Centaur's visual and/or auditory feedback options as well as determine how often Centaur will update the Real-Time Events/Status window. The options are detailed below.

#### Setting Alarm Acknowledgement Options

The following options are available under the **Alarms** heading. These options only apply if alarm acknowledgement is enabled (see "Enabling Alarm Acknowledgement" on page 166).

##### Display a Notification Message

When the **Display a notification message** check box is selected, a pop-up window will appear to notify you that an alarm requiring acknowledgement has occurred when your Centaur integrated access control software is minimized or running in the background. Therefore, if you are working in another program such as Microsoft Word, or if the Centaur integrated access control software is minimized, a pop-up window will appear asking you if you would like to view the alarm now. If you click **Yes**, it will maximize (return) to the Centaur integrated access control software. If you choose to ignore the alarm, click **No**.

##### Make a Beep

When the **Make a beep** check box is selected, your computer will beep every time an alarm requiring acknowledgement occurs.

##### Play Alarm Wave Non-Stop

When the **Play Alarm Wave Non-Stop** check is selected, your computer will play the selected **Wave** file continuously when an alarm requiring acknowledgement occurs. The computer will stop playing the wave file only when the alarm is acknowledged.

##### Wave

When the **Play Alarm Wave Non-Stop** check is selected, select a wave file.



# CENTAUR

## Integrated Access Control V8.0

### Setting General System Event Options

The following options are available under the **Events** heading.

#### Make a Beep on all Events

When the **Make a beep on all events** check box under the **Events** heading is selected, your computer will beep every time an event appears in the Real-Time Events/Status window.

#### Make a Beep on All Access Events

When the **Make a beep on all Access events** check box is selected, your computer will beep every time an Access event appears in the Real-Time Events/Status window. Access events consist of any event generated that is linked to the status of the doors in the system such as "Access Granted", and "Access Denied".

#### Make a Beep on All Abnormal Events

When the **Make a beep on all Abnormal events** check box is selected, your computer will beep every time an abnormal event appears in the Real-Time Events/Status window. Abnormal events consist of any event generated that is uncommon to normal site operation such as "Door Left Open", "Door Forced Open", "Relay Activated by Operator", and any troubles.

#### Update events every

This option determines at what intervals the Centaur integrated access control software will refresh the Real-Time Events/Status window. From the **Update events every** drop-down list, select the desired interval of time.

### Setting the Event Status Refresh Rate

This option determines at what intervals the Centaur integrated access control software will refresh the Real-Time Events/Status window when displaying the status of devices in the system such as doors and controllers. For information on displaying the status of devices in the system, refer to "Manual Controls" on page 246. From the **Update status display every** drop-down list under the **Status** heading, select the desired interval of time.

# CENTAUR

## Integrated Access Control V8.0

### EVENT COLOUR DEFINITIONS

Centaur provides the ability to customize the text and background colour of each event logged in the system. You can set events to use its default colours or a custom colour definition. When an event occurs, it will appear in the Real-Time Events/Status window with its defined colours (default or custom).

#### Using Default System Event Colours

Perform the following to use an event's default system colours

1. From Centaur's main menu, select the **Options** menu and **Event Colours**.
2. From the Event Colours window, highlight the desired event.
3. Select the **Use System Colours** check box.
4. Repeat steps 2 and 3 until the desired events are set.
5. Click **OK**.

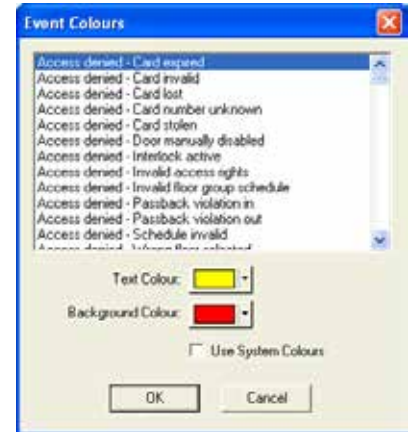

#### Customizing Event Colours

Perform the following to set an event to use a custom set of colours.

1. From Centaur's main menu, select the **Options** menu and select **Event Colours**.
2. From the Event Colours window, highlight the desired event.
3. Clear the **Use System Colours** check box.
4. Select the desired colours from the **Text Colour** and **Background Colour** drop-down lists.
5. Repeat steps 2 to 4 until the desired events are set.
6. Click **OK**.

# CENTAUR

## Integrated Access Control V8.0

### Customizing Event Colours

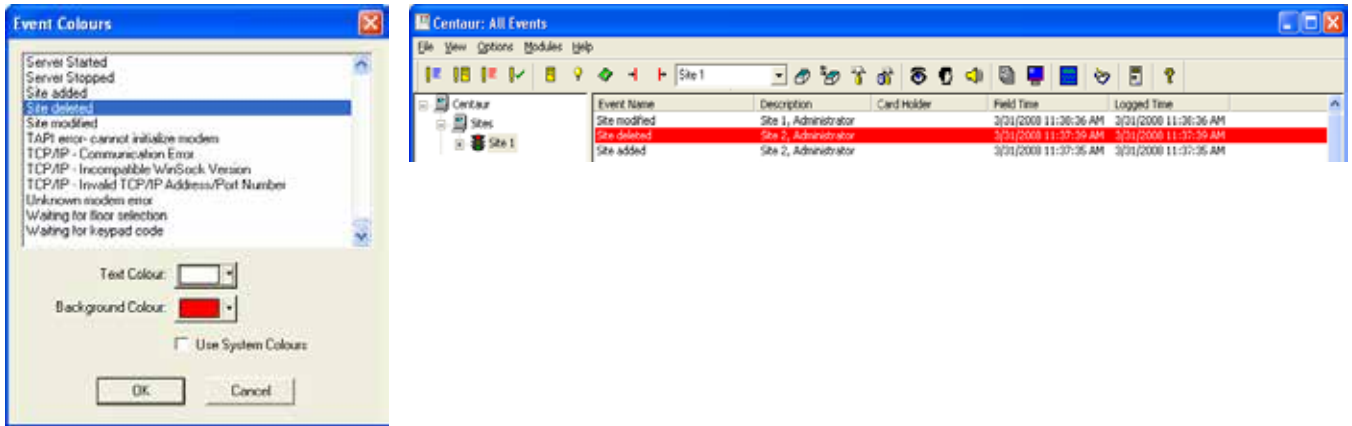

## OPERATOR TIMEOUT

The Centaur administration consoles can be programmed to log off automatically when no action (i.e. programming, viewing system status, etc.) for a specified amount of time.

1. From Centaur's main menu, select the **Options** menu and select **Operator Timeout**.
2. The **Operator Timeout** window will appear. In the **Timeout** text field, type a value in minutes from **0** to **65536**. To disable this feature, type **00000**.
3. Click **OK**.

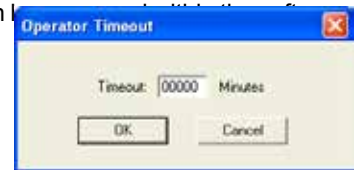

## LOG FILE

Centaur can automatically save a .xml log file of events to your hard drive. This is convenient in the event that you require assistance from our technical support team and a log of recent events is required.

1. From Centaur's main menu, select the **Options** menu and select **Log File**.
2. The **Log file options** window will appear. Select the **Enable Log** check box. This feature is disabled when the check box is cleared.
3. In the **Log file limit** text field, type a value in amount of entries from 10 to 1000.
4. Click **OK**.



# CENTAUR

Integrated Access Control V8.0

# CENTAUR

## Integrated Access Control V8.0



## Parking

### What Will I Find?

---

Using the Centaur software, you can control the access to the parking. The access to the parking may be assigned to specific users and to members of user and visitor group. A relay may be activated to indicate that the parking is full.

# CENTAUR

## Integrated Access Control V8.0

## OVERVIEW OF PARKING MANAGEMENT

---

Parking management allows you to define the parking capacity, select a relay that will be activated when the parking is full, and whom will have access to the parking.

### Quick Start Programming

To properly set up Centaur for parking management, several different elements must be programmed as defined here:

1. Access the Site Properties window by right-clicking on the desired site from the Database Tree View window and selecting **Properties** from the drop-down list. You can also select the desired site and press the keyboard **Enter** key. In the **Site Properties** window, select the **Visitors & Parking** tab, activate the parking counter, set the parking capacity, and select a relay that will be activated when the parking is full (see “Visitors & Parking” on page 45).
2. Program the door’s reader for parking global entry or global exit. The door cannot be used for any other purpose other than parking management. Access the Door Properties window by right-clicking on the desired door from the desired controller’s branch within the selected site and clicking **Properties** from the drop-down list. You can also select the desired door and press the keyboard **Enter** key. In the **Door Properties** window of the desired door, select the **General** tab and set the **Door Type** to **Parking Global Entry** or **Parking Global Exit** (see “Door Settings” on page 120). Please note that you cannot use any doors from the 2-Door Expansion Modules for parking management.
3. You must create a user/visitor group that will have access to the parking. Expand the **Users** or **Visitors** branch within the Database Tree View window, right-click on the desired user or visitor group, and click **Properties**. Select the **Parking** tab, set the parking capacity for this group, and select a relay that will be activated when the parking is full (see “Defining Parking Rules for the User Group” on page 73 and “Defining Parking Rules for the Visitor Group” on page 87).

# CENTAUR

## Integrated Access Control V8.0



## Parcel Pick Up Guide

### What Will I Find?

---

The parcel pick up feature issues a one-time usage PIN code to unlock one storage locker at any time of day or night - any day of the week, only at specified days and times. Will automatically send an email to advise a client that their parcel is ready for pick up. Disable the PIN code after one valid use.

# CENTAUR

## Integrated Access Control V8.0

### PRE-REQUISITES

---

1. Centaur 5.2 software.
2. One CT-V900-A door controller.
3. One CA-A480-A elevator controller per 16 lockers (maximum 64 lockers).
4. One GALEO/W keypad.
5. Locker compartments.
6. Lock device(s) - one per locker.
7. External power supplies (sufficient for lock devices).

# CENTAUR

## Integrated Access Control V8.0

### CONFIGURATION

#### Email SMTP Settings

1. In the Centaur database tree, right-click the site name and select “SMTP Settings”.

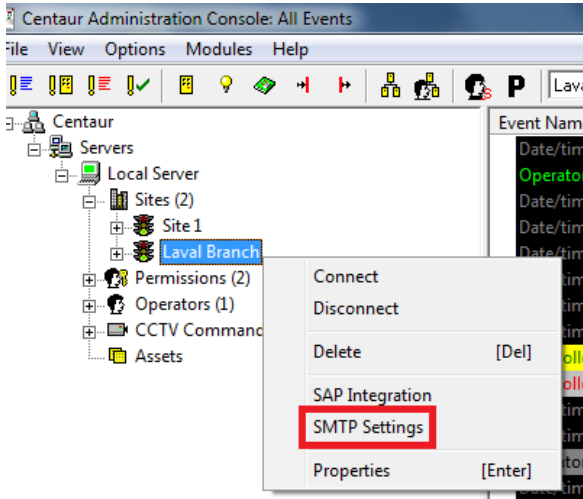

2. Enter the required email account information used by Centaur to send emails.
3. Enter the first line of text that will appear in the body of the email in the “Custom Header” section (optional).

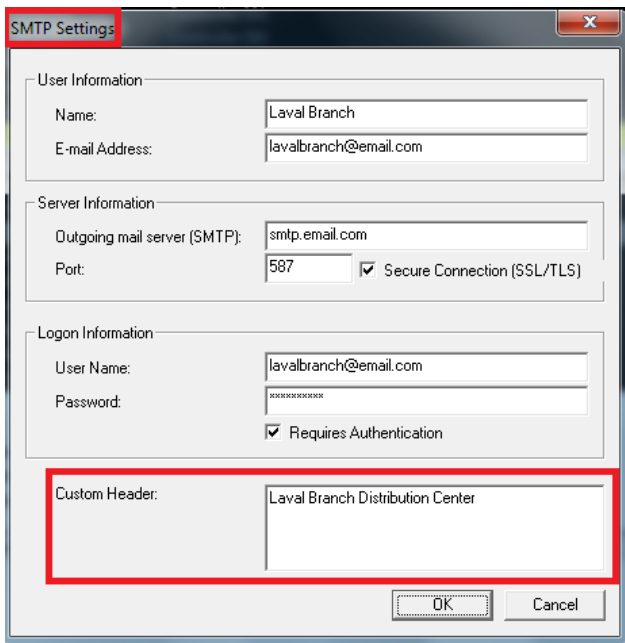

4. Click “OK” to save and exit.



The SMTP settings displayed above are for instructional purposes only. Use your email account SMTP settings to enable Centaur to send emails.

# CENTAUR

## Integrated Access Control V8.0

### Controller Properties

1. In the Centaur database tree, right-click the CT-V900-A controller and select “Properties”.
2. Click on the “Configuration” tab.
3. Select “None” in the “Reader” field.
4. Select “Motorola ARK” in the “Keypad” field.
5. Click “OK” to save and exit.

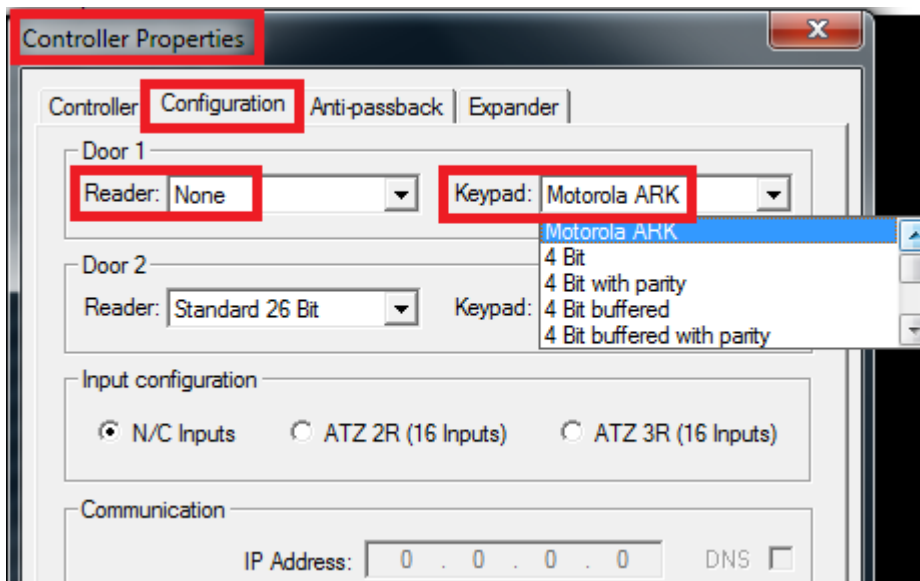

This guide assumes the CDVI GALEO/W keypad will be connected to the CT-V900-A reader port 1. Other keypads may be compatible but have not been tested. Refer to the GALEO/W manual to configure the keypad with the following settings: 26 bit wiegand mode, 5 digit PIN codes, Motorola ARK mode.



CDVI GALEO/W keypad

# CENTAUR

## Integrated Access Control V8.0

### Door Properties

1. In the Centaur database tree, right-click the door (Door 001:01) and select "Properties".

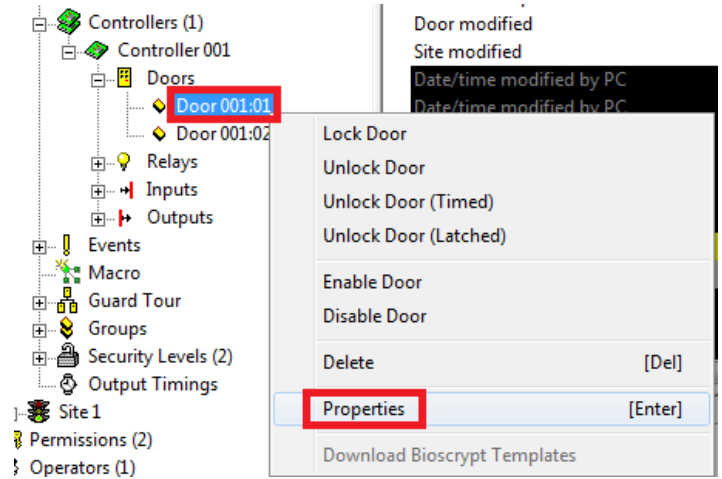

2. Click the "Door" tab and rename the door.

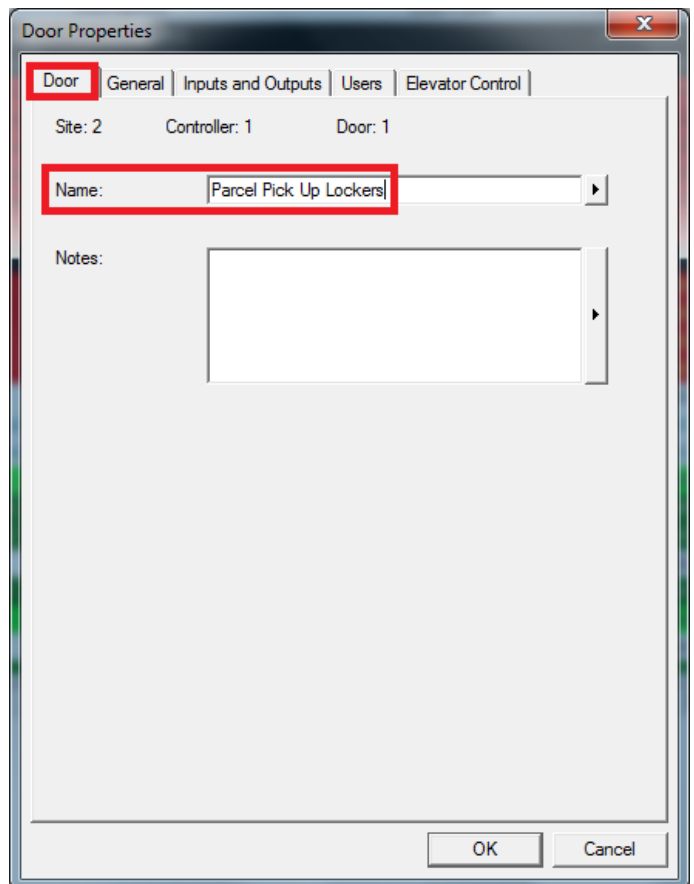

# CENTAUR

## Integrated Access Control V8.0

3. Click the “General” tab and set:
  - a) Door Type – Elevator
  - b) Reading device – Keypad
  - a) Keypad Schedule – Always
  - b) Activate () the “Counter” option (located at the bottom-left of the window).
4. Adjust the “Unlock Time” setting in accordance with the time it will take a client to reach the furthest locker from the keypad location. Maximum value is 255 seconds (4 min 15 sec).

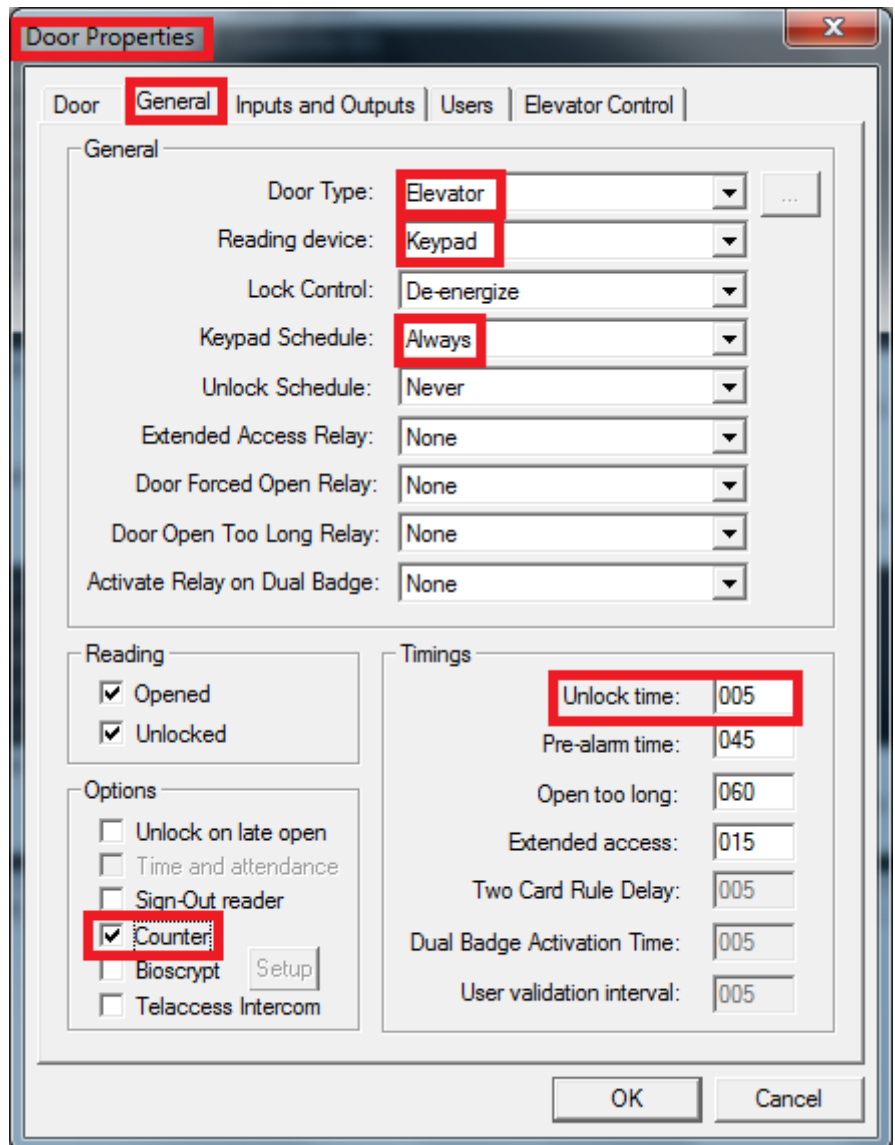

# CENTAUR

## Integrated Access Control V8.0

5. Select the "Inputs and Outputs" tab and set:
  - a) Door Input section:
    - i. Input – None
    - ii. Relock – Disabled
  - b) REX Input section:
    - i. Input – None
    - ii. Relock – Disabled
    - iii. Schedule – Never
    - iv. Unlock on Rex (Normal) – Not checked
6. Click "OK" to save and exit.

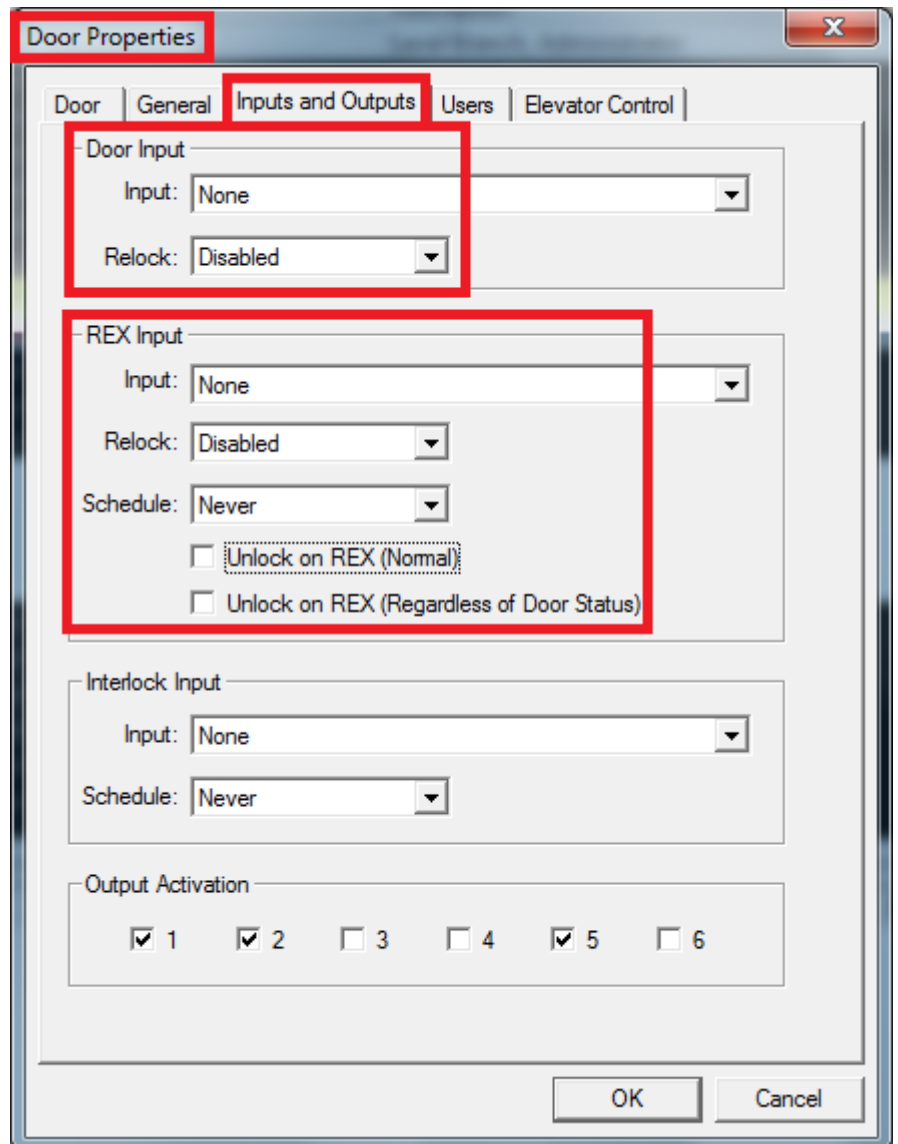

# CENTAUR

## Integrated Access Control V8.0

### Site Properties

7. In the Centaur database tree, right-click your site and select “Properties”.

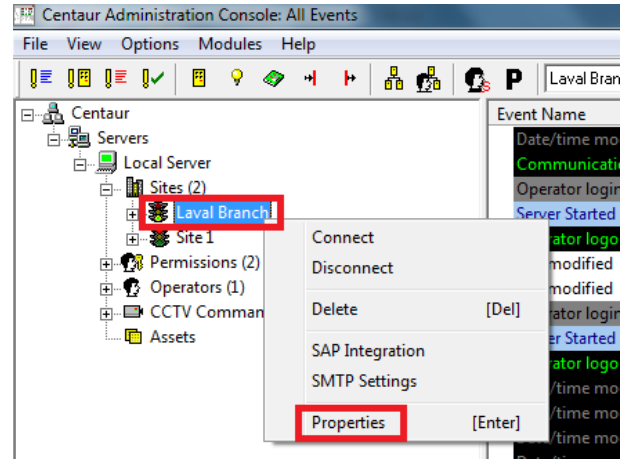

8. Click on the “Floors” tab.

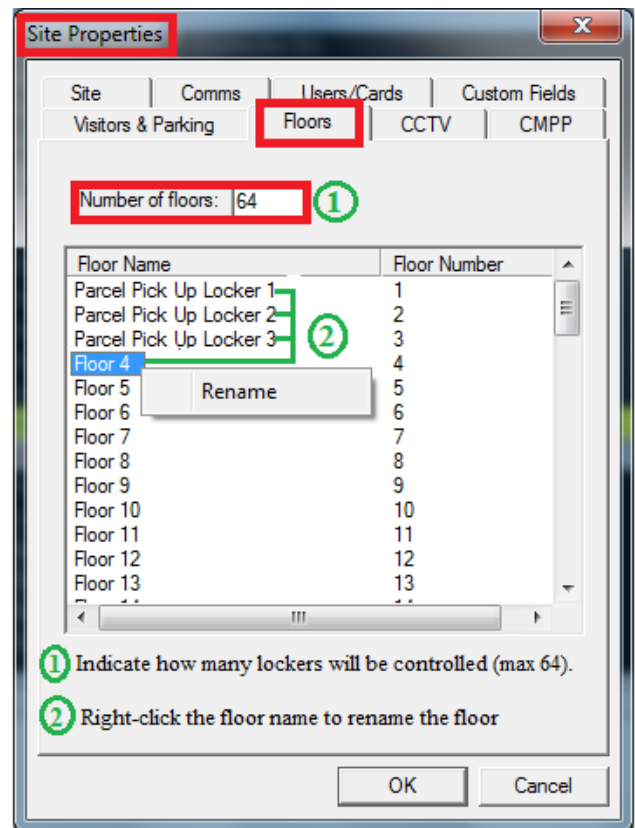

9. Indicate how many lockers will be controlled by the system (1).  
For programming purposes, note that each locker is a “floor”.

10. Right-click the default floor name to rename it (2).

# CENTAUR

## Integrated Access Control V8.0

### Floor Groups

1. In the Centaur database tree, expand “Groups” (click the “+” sign).
2. Right-click “Floor Groups” and select “New Floor Group”.

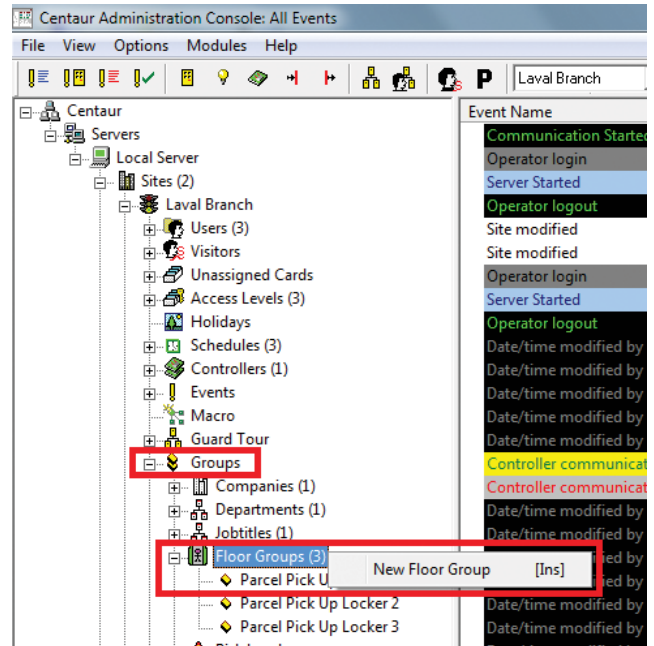

3. Assign an appropriate name to the Floor Group. Note that each “floor group” will be one locker only.

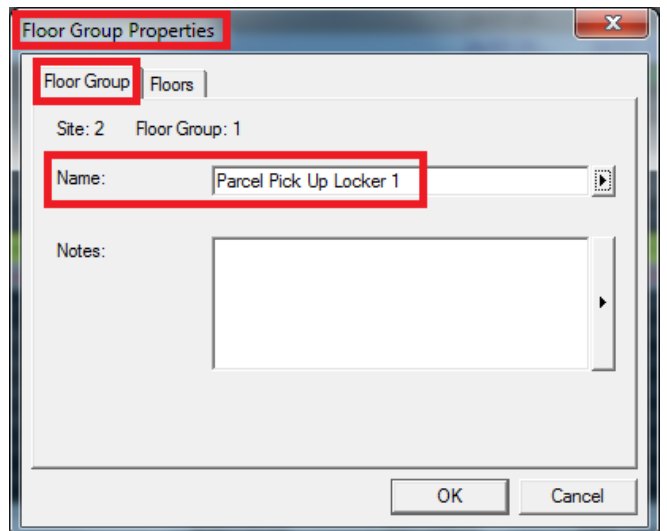

# CENTAUR

## Integrated Access Control V8.0

- Click on the “Floors” tab, select the appropriate floor/locker and assign a schedule when access will be permitted to the locker.

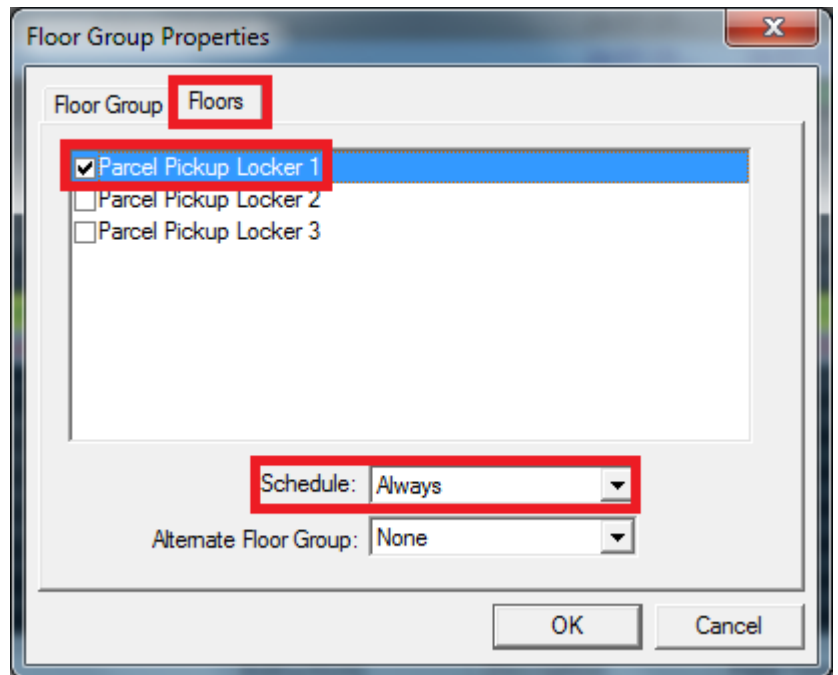

- Create a floor group for each locker by repeating steps 2, 3 and 4 listed above.

### Access Levels

- In the Centaur database tree, right-click “Access Levels” and select “New Access Level”

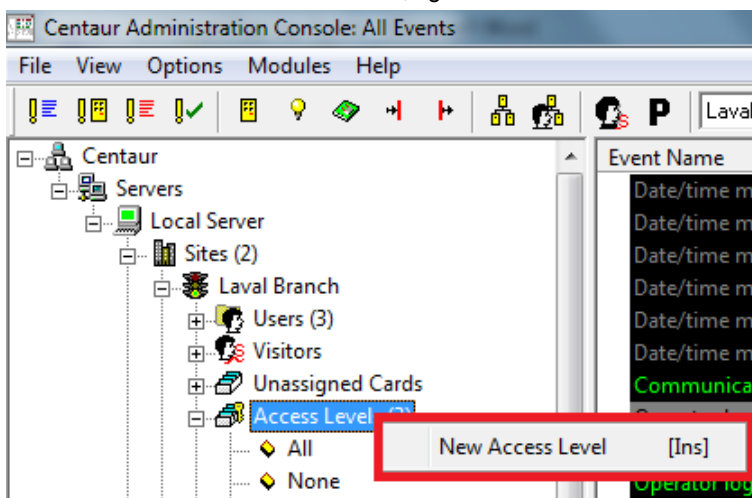



# CENTAUR

## Integrated Access Control V8.0

### Site Properties

1. In the Centaur database tree, right-click your site and select "Properties".

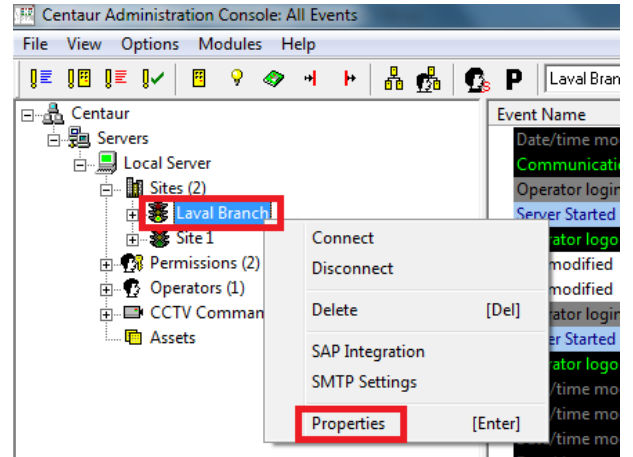

2. Click on the "Users/Cards" tab and select Parcel Pick Up Lockers Access Level as the "Default Access Level".

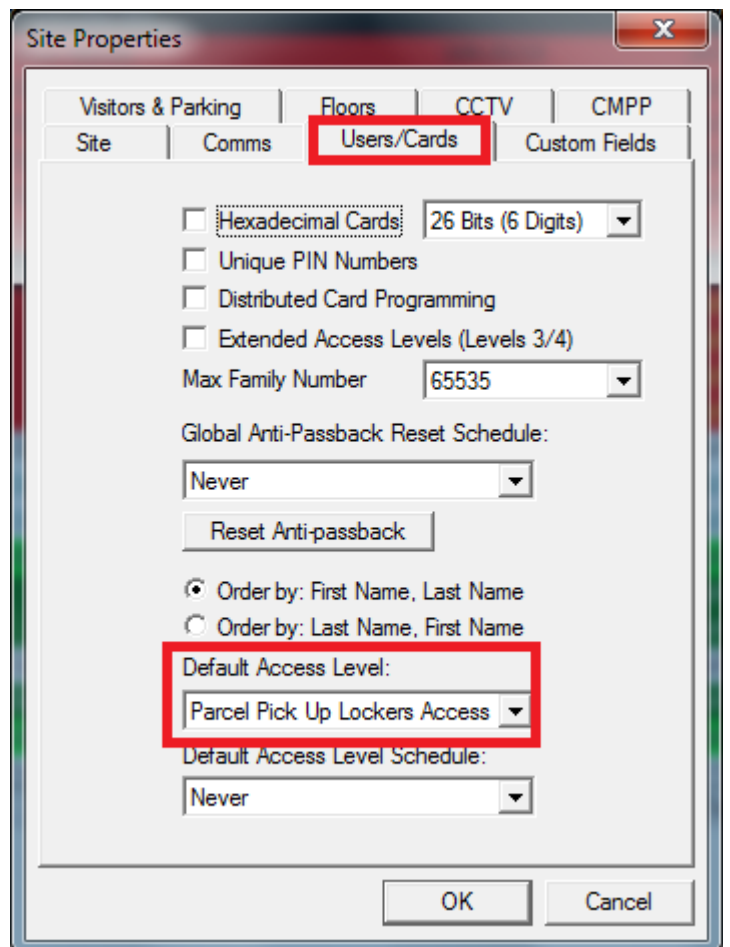

# CENTAUR

## Integrated Access Control V8.0

### Issuing a PIN code - Sending an email

1. Click on the “Parcel Pick Up” button located on the Centaur toolbar above the events window.

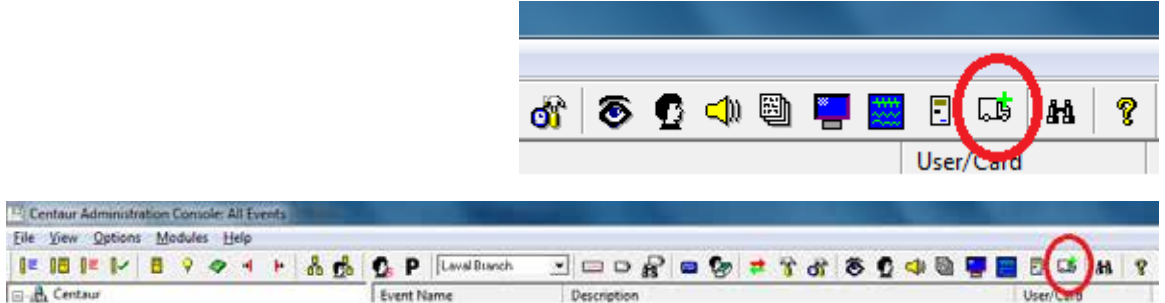

2. The following “Pick –Up (One Time Usage)” window will appear.

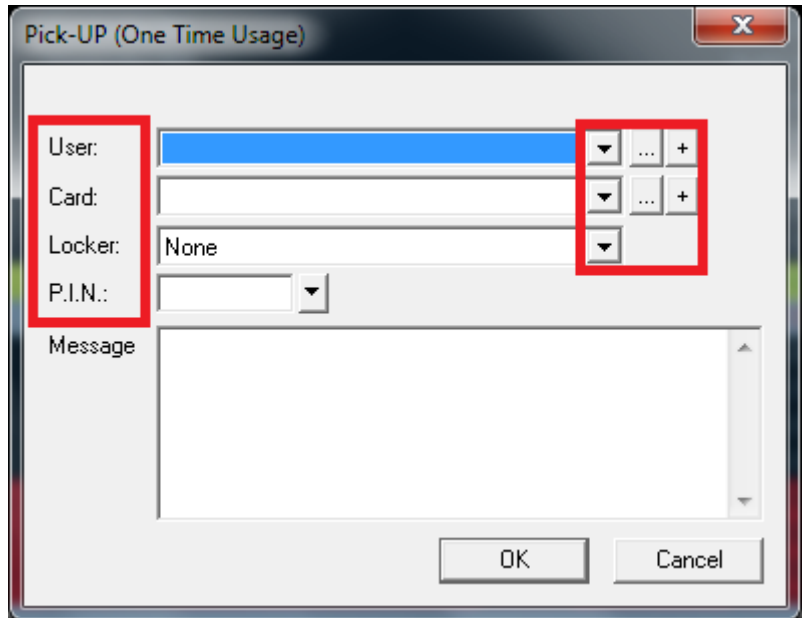

3. The drop-down buttons are used to select an existing User, Card and Locker.
4. The drop-down button is used to automatically generate a unique Personal Identification Number (P.I.N) code as shown below (step 9).
5. To edit an existing User, select a User with the drop-down button and click the browse button .

# CENTAUR

## Integrated Access Control V8.0

- To create a new User, click the “add” button . Enter the User’s Name and email address (required). Other information may also be added (optional).
- Click “OK” to save and exit.

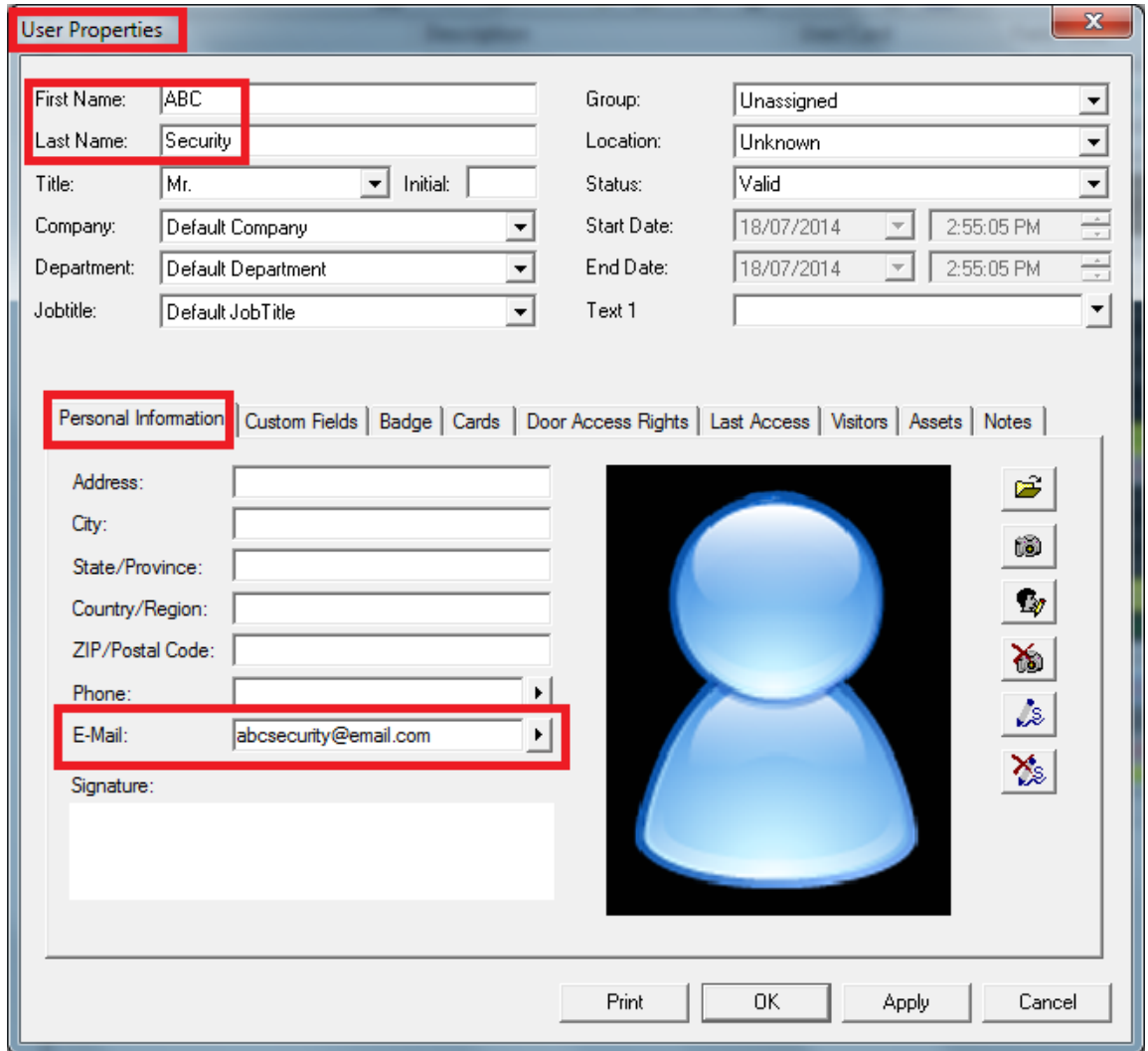

**User Properties**

First Name: ABC  
 Last Name: Security  
 Title: Mr. Initial:   
 Company: Default Company  
 Department: Default Department  
 Jobtitle: Default JobTitle  
 Group: Unassigned  
 Location: Unknown  
 Status: Valid  
 Start Date: 18/07/2014 2:55:05 PM  
 End Date: 18/07/2014 2:55:05 PM  
 Text 1:   
**Personal Information** | Custom Fields | Badge | Cards | Door Access Rights | Last Access | Visitors | Assets | Notes  
 Address:   
 City:   
 State/Province:   
 Country/Region:   
 ZIP/Postal Code:   
 Phone:   
**E-Mail: abcsecurity@email.com**  
 Signature:   
 Print OK Apply Cancel

- Create, edit or select cards in the same fashion as a User. Note that no “physical” card will be issued. Only a PIN code will be required to access the locker.

# CENTAUR

## Integrated Access Control V8.0

9. Click the drop-down button  to select the locker the parcel has been placed in.

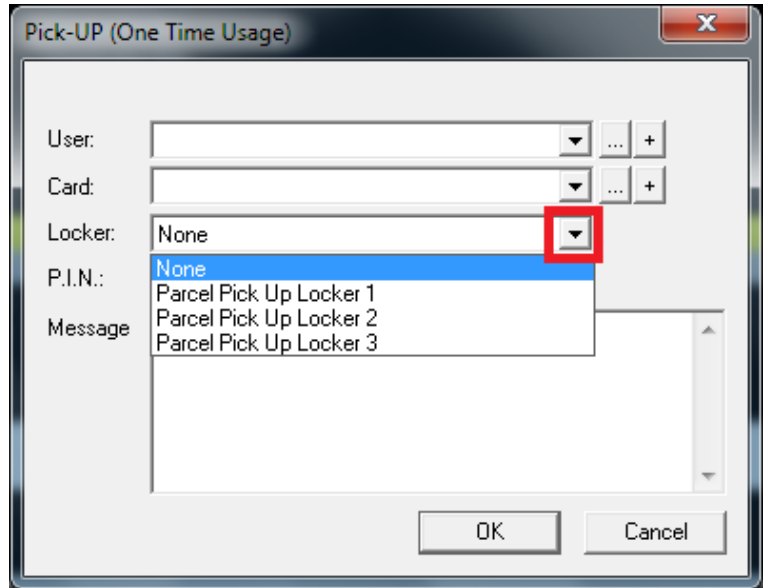

10. Manually enter a P.I.N. code or click the drop-down button  to have Centaur automatically generate one for you.

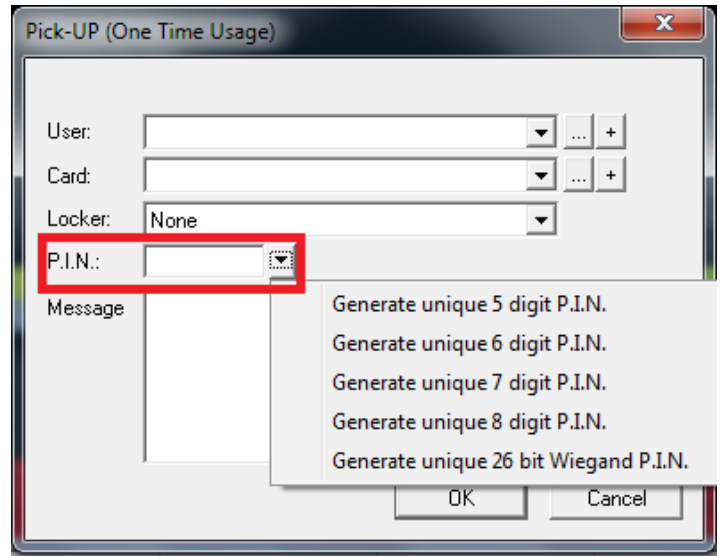

- Since the Galeo/w keypad was configured in 5-digit PIN mode, select “Generate unique 5 digit P.I.N.”
- Only generate 6, 7, 8 or 26 bit Wiegand P.I.N. codes if they are supported by the keypad.
- If entering a P.I.N. code manually, only P.I.N. codes between 00001 and 65595 are valid. This will be the case with the current configuration of the Galeo/w.

# CENTAUR

## Integrated Access Control V8.0

11. Enter a personalised message that will be included in the email (optional).

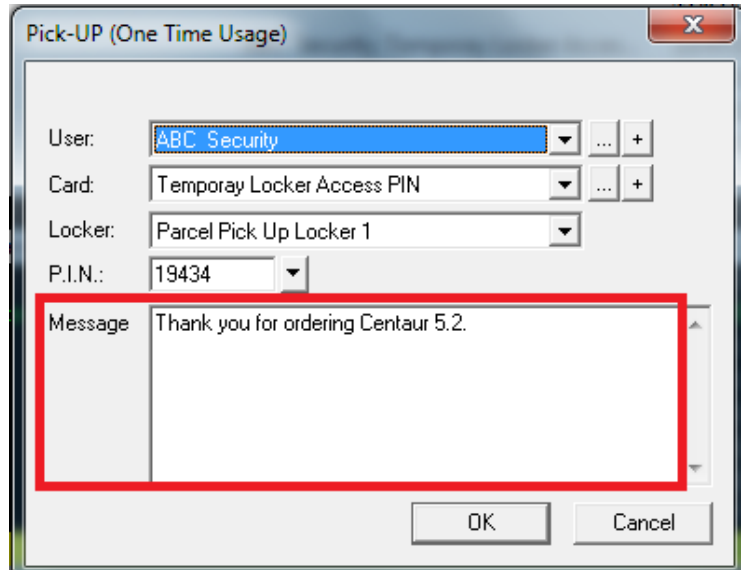

### Email received by the Client

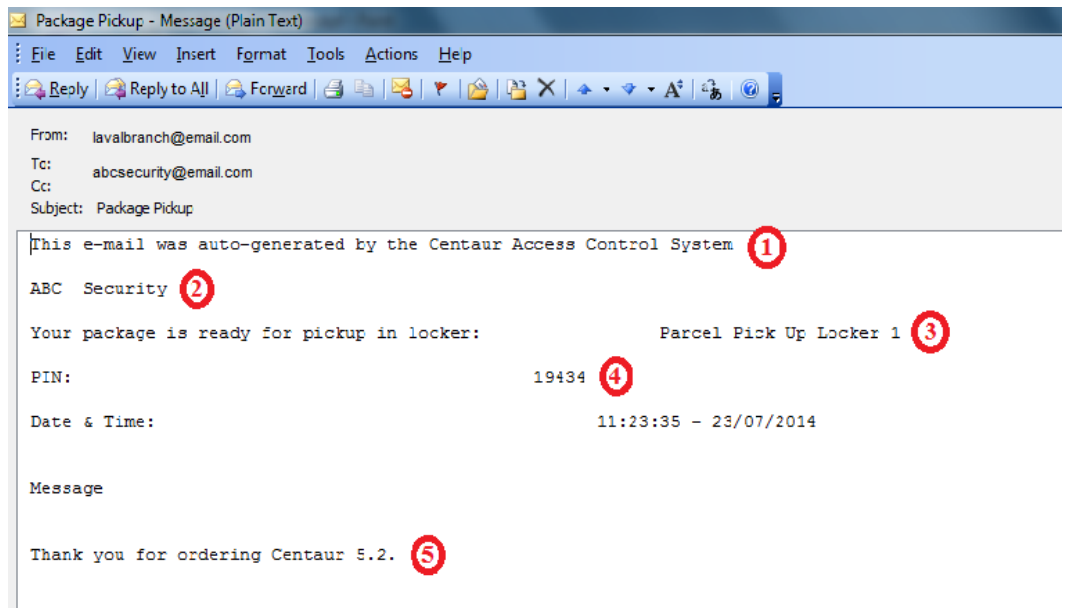

1. Default Header text. Can be modified. Refer to “Email SMTP Settings” section.
2. Client Name
3. Locker Name
4. One-time usage P.I.N. code
5. Text entered in the “Message” area of the Pick-Up (One Time Usage) window. Refer to step 10 in the “Issuing a PIN Code – Sending an email” section

# CENTAUR

## Integrated Access Control V8.0



## Manual Controls

### What Will I Find?

---

Centaur includes an intuitive toolbar that you can use to display the status of specific output and input devices as well as control the activation and deactivation of those devices. In each site, you can view and control the status of the controllers, doors, inputs, outputs, and relays.

# CENTAUR

## Integrated Access Control V8.0

## EVENT DISPLAY

---

The following sections describe how an operator can view some or all of the events in the system. For details on how they are displayed, refer to “Events” on page 161. Make sure you select the appropriate site from the desired site branch in the Database Tree View window. Appropriate operator permissions and security levels must be enabled (see “Operators” on page 196).

### Display All Events



When you click on the **All events** icon, the last 1000 events that occurred in the selected site will appear along with its details in the Real-Time Events/Status window.

### Display Access Events



When you click on the **Access events** icon, any of the last 1000 events generated that is linked to the status of the doors in the selected site (i.e. “Access Granted”, “Card Traced”, etc.) will appear along with its details (i.e. company name and information about the user) in the Real-Time Events/Status window.

### Display Abnormal Events



When you click on the **Abnormal events** icon, any of the last 1000 events generated that is uncommon to normal site operation (i.e. “Door Left Open”, “Relay Activated by Operator”, troubles, etc.) will appear along with its details in the Real-Time Events/Status window.

### Display Acknowledged Events



Any of the last 1000 events in the site can be programmed to require operator acknowledgement (see “Alarm Acknowledgement” on page 166). When you click on the **Acknowledged events** icon, any event that requires acknowledgement and has been acknowledged by an operator will appear along with its details in the Real-Time Events/Status window.

### Display Guard Tour Events



When you click on the **Guard Tour Events** icon, the last 1000 guard tour events that occurred in the selected site will appear along with its details in the Real-Time Events/Status window.

## MANUAL CONTROLS

---

The following sections describe how an operator can view the status of the devices in the system and how they can remotely control these devices (i.e. enable or disable a relay, etc.). Make sure you select the appropriate site from the desired site branch in the Database Tree View window. Appropriate operator permissions and security levels must be enabled (see “Operators” on page 196).

### Displaying and Controlling the Status of a Door



When you click on the **Door status** icon, Centaur will display the current (live) status of the doors in the system. If you wish to manually change the status of a door, right-click the desired door. You can also select multiple doors to manually change in the same way by clicking on the doors while holding down the **Shift** or **Ctrl** keys and right-clicking on one of the selected doors. A drop-down list will appear. Select one of the following actions from the list. Also, refer to figure “Door Status and Manual Controls” on page 249

#### Lock Door

Locks the selected door if it was unlocked on schedule, manually or by an operator.

#### Unlock Door

Unlocks the selected door for the period specified by the door’s Unlock Time (see “Setting the Door Timers” on page 125).

#### Unlock Door (Timed)

Unlocks the selected door for a programmed period of time. When you select this action, the Activation Time window will appear. In the text box, type a value from 1 second to 65535 seconds, and click **OK**.

#### Unlock Door (Latched)

Unlocks the selected door until an operator re-locks the door using the Lock Door manual command (see “Lock Door” above) or until locked by the door’s schedule (see “Unlock Schedule” on page 123).

#### Enable Door

When an operator manually bypasses a door (see “Disable Door” below), this command will reinstate the active state of the selected door.

#### Disable Door

Allows the operator to manually bypass the selected door. The active state of the door is reinstated when the operator uses the Enable Door command (see above) or when enabled by the door’s enabling schedule (see “Unlock Schedule” on page 123).

# CENTAUR

## Integrated Access Control V8.0

### Door Status and Manual Controls

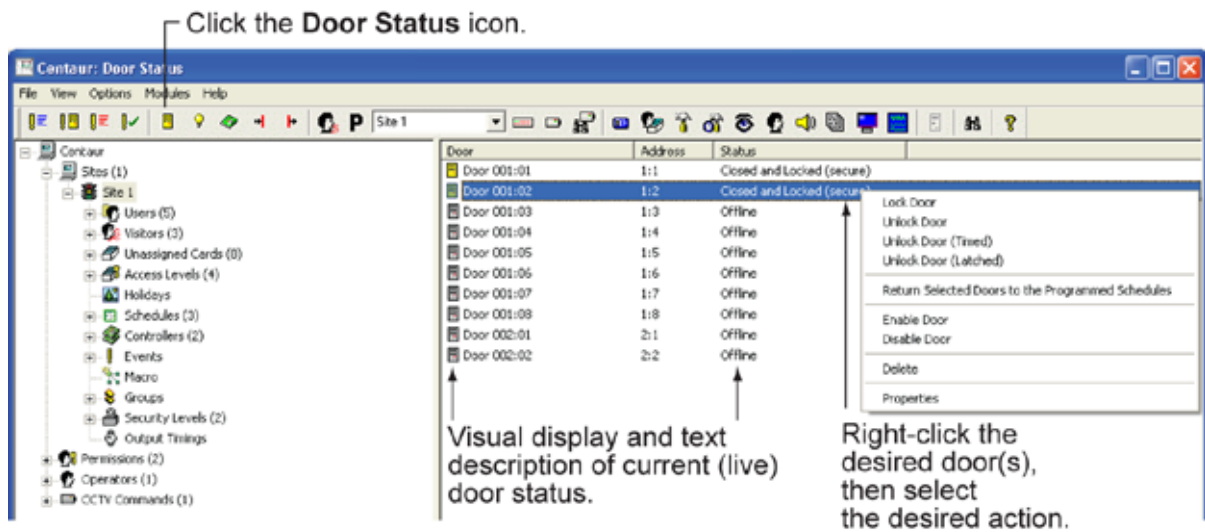

## Displaying and Controlling the Status of a Relay



When you click on the **Relay status** icon from the menu bar, Centaur will display the current (live) status of the relays in the system. If you wish to manually change the status of a relay, right-click the desired relay. You can also select multiple relays to manually change in the same way by clicking on the relays while holding down the **Shift** or **Ctrl** keys and right-clicking on one of the selected relays. A drop-down list will appear. Select one of the following actions from the list. Also, refer to figure “Display Relay Status” on page 250.

### Activate Relay

Activates (toggles) the selected relay for the period specified by the relay’s Activation Time (see “Setting the Relay Activation Timer” on page 153). If a relay’s **Delay on Activation Time** is programmed (see “Setting the Relay Delay Time Before Activation” on page 140), the relay will only activate after this delay has elapsed.

### Activate Relay (Timed)

Activates (toggles) the selected relay for a programmed period of time. When you select this action, the Activation Time window will appear. In the **Time (seconds)** text box, type a value from 1 to 65535 seconds and click **OK**.

### Activate Relay (Latched)

Activates (toggles) the selected relay until an operator deactivates the relay using the Deactivate Relay manual command (see “Deactivate Relay” below or until deactivated by the relay’s schedule (see “Selecting a Time Relay Activation Schedule” on page 152).

### Deactivate Relay

Deactivates the selected relay.

# CENTAUR

## Integrated Access Control V8.0

### Display Relay Status

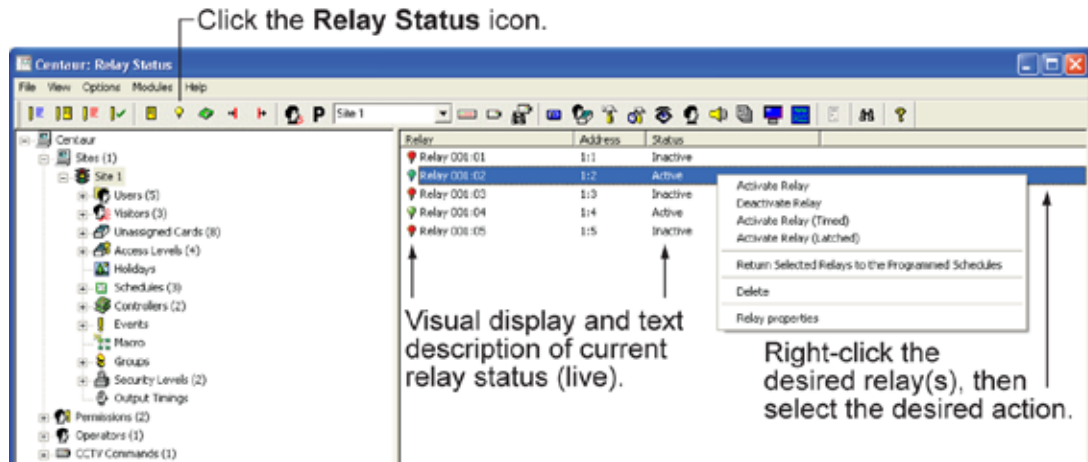

### Displaying Controller Status



When you click on the **Controller status** icon from the menu bar, Centaur will display the current (live) status of the controllers in the selected site.

### Display Controller Status

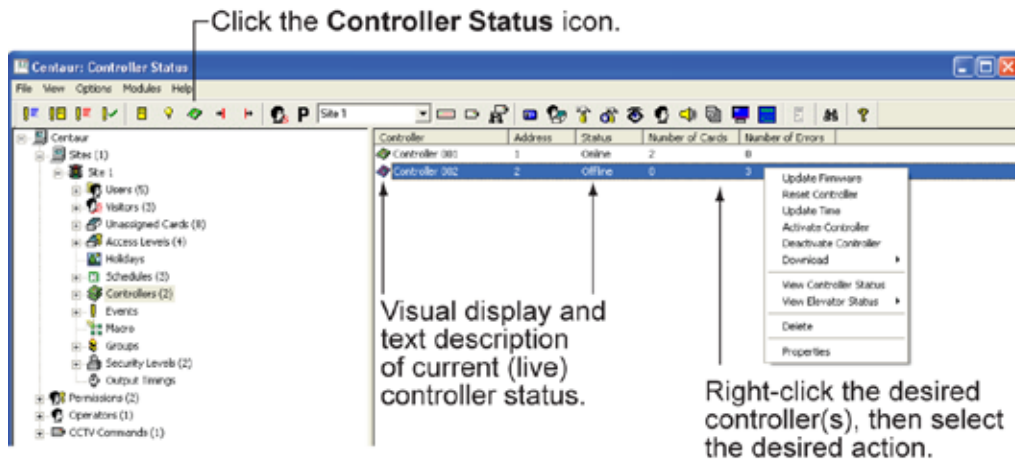

# CENTAUR

## Integrated Access Control V8.0

### Displaying and Controlling the Status of an Input



When you click on the **Input Status** icon from the menu bar, Centaur will display the current (live) status of the inputs in the system. If you wish to manually enable/disable an input, right-click the desired input. You can also select multiple inputs to manually enable/disable in the same way by clicking on the inputs while holding down the keyboard **Shift** or **Ctrl** keys, and right-clicking on one of the selected inputs. A drop-down list will appear. Select one of the two following actions from the list. Also, refer to “Inputs” on page 156.

#### Enable Input

When an operator manually bypasses (disables) an input, this command will reinstate the active state of the selected input.

#### Disable Input

Allows the operator to manually bypass the selected input. The active state of the input is reinstated when the operator uses the Enable Input command or when enabled by the input’s enabling schedule (see “Selecting the Input Enabling Schedule” on page 162).

Display Input Status

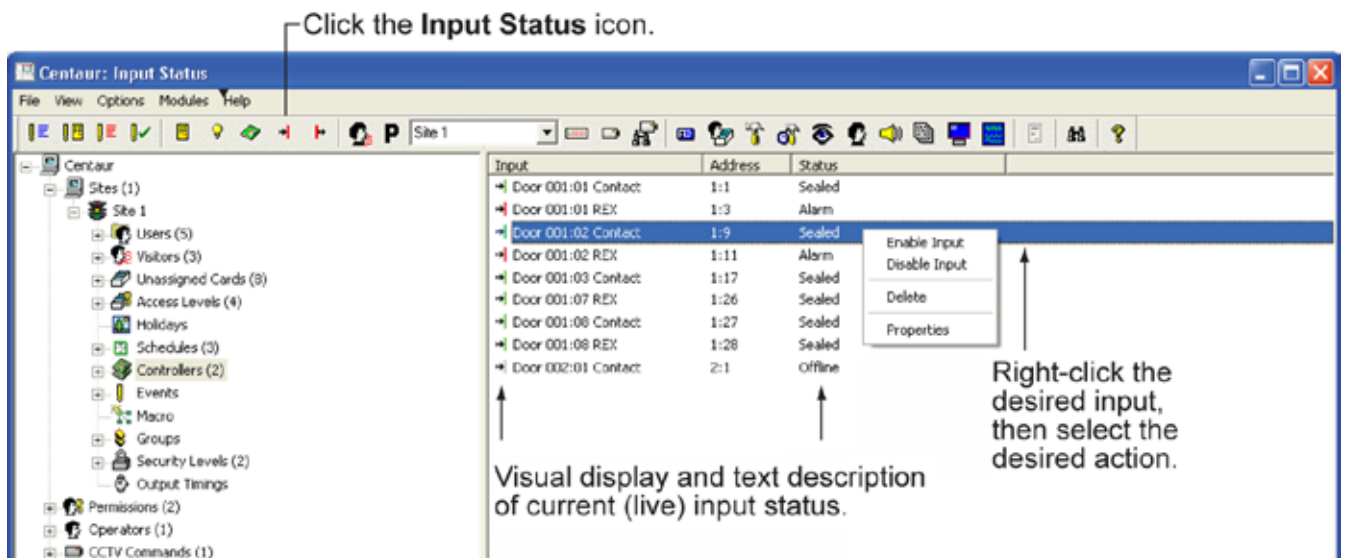

# CENTAUR

## Integrated Access Control V8.0

### Displaying and Controlling the Status of an Output



When you click on the **Output Status** icon from the menu bar, Centaur will display the current (live) status of the outputs in the system. If you wish to manually change the status of an output, right-click the desired output. You can also select multiple outputs to manually change in the same way by clicking on the outputs while holding down the keyboard **Shift** or **Ctrl** keys, and right-clicking on one of the selected outputs. A drop-down list will appear. Select one of the following actions from the list. Also, refer to “Outputs” on page 166.

#### Activate Output

Activates the selected output for the period specified by the output’s Activation Time (see “Setting the Output Activation Events” on page 169).

#### Activate Output (Timed)

Activates the selected output for a programmed period of time. When you select this action, the Activation Time window will appear. In the text box, type a value from 1 to 99999 seconds, and click **OK**.

#### Deactivate Output

Deactivates the selected output.

Display Output Status

Click the **Output Status** icon.

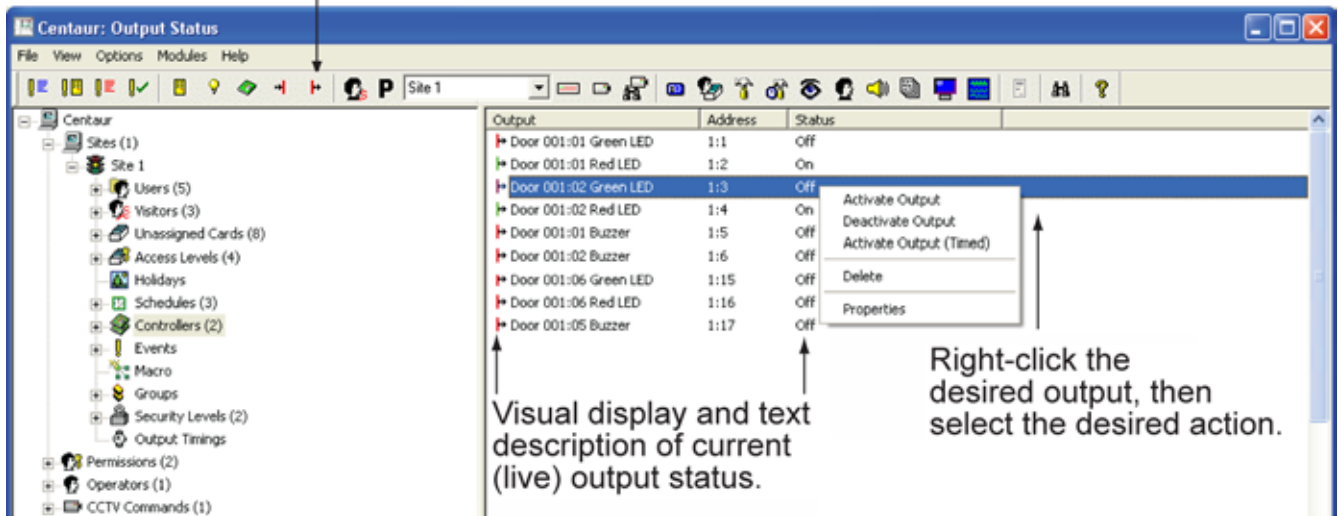

Visual display and text description of current (live) output status.

Right-click the desired output, then select the desired action.

# CENTAUR

## Integrated Access Control V8.0

### Displaying Guard Tour Live Rounds

When you click on the **Guard Tour Live Rounds** icon from the menu bar, Centaur will display the current (live) status of the rounds in the system. If you wish to start, end, or view round details, right-click the desired round and select one of the following actions from the list. Also, refer to “Guard Tour” on page 190.

#### Start Round

Starts the selected guard tour round and displays its check point details.

#### End Round

Ends the selected guard tour round.

#### View Round Details

Displays check point details of the selected round.

*View Round Details*

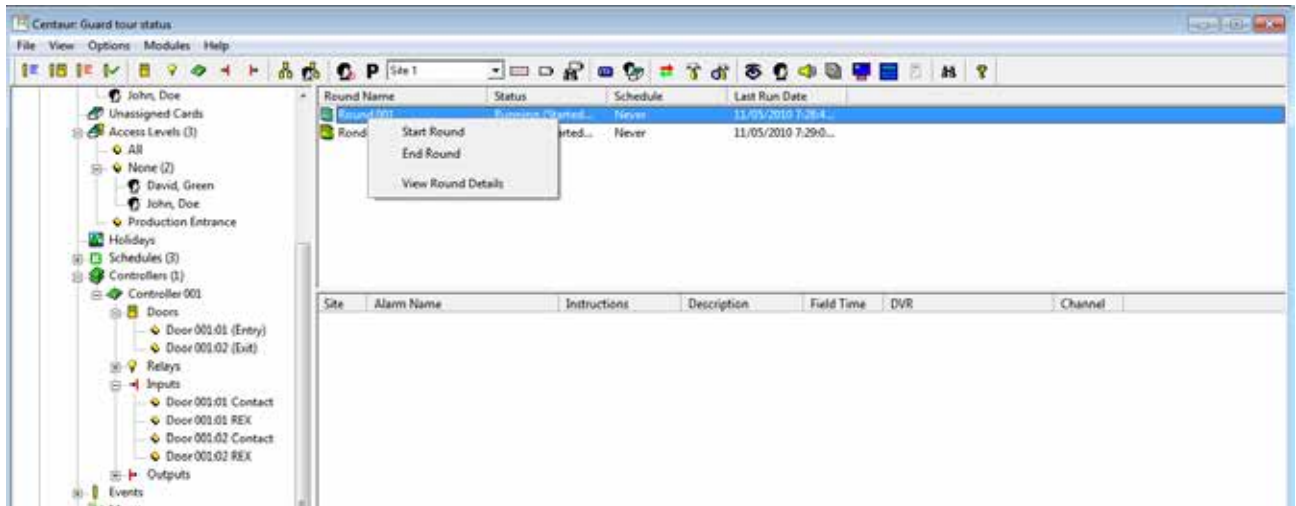

#### Extend Time

If you wish extend the time of a check point, right-click on the desired check point, select **Extend Time** and enter the new time.

#### Validate Check Point

To manually validate a check point, right-click on the desired check point and select **Validate Check Point**.

# CENTAUR

## Integrated Access Control V8.0

### Displaying Visitor Status



When you click on the **Displaying Visitor Status** icon from the menu bar, Centaur will display the list of visitors that are currently (live) signed in. If you wish to manually change the status of a visitor, right-click the desired visitor's name. A drop-down list will appear. Select one of the following actions from the list. Also, refer to "Visitors and Visitor Groups" on page 78.

#### View Current Visit Details

Displays the visitor's picture, reference signature and notes.

#### Sign-Out

Signs out the selected visitor. The operator will be prompted to ask for a signature and the visitor will be erased from the list if the option **Require signature upon departure** is checked. The visitor's card(s) will be disabled when the option **Disable visitor's card(s) upon departure** is checked. The visitors's card(s) will be unassigned when the option **Unassign visitor's card(s) upon departure** is checked. Refer to "Options" on page 222 for more information.

#### Properties

Displays the **Visitor Properties** window with the **History** tab selected displaying the event's history for the current visitor.

Display Visitor Status

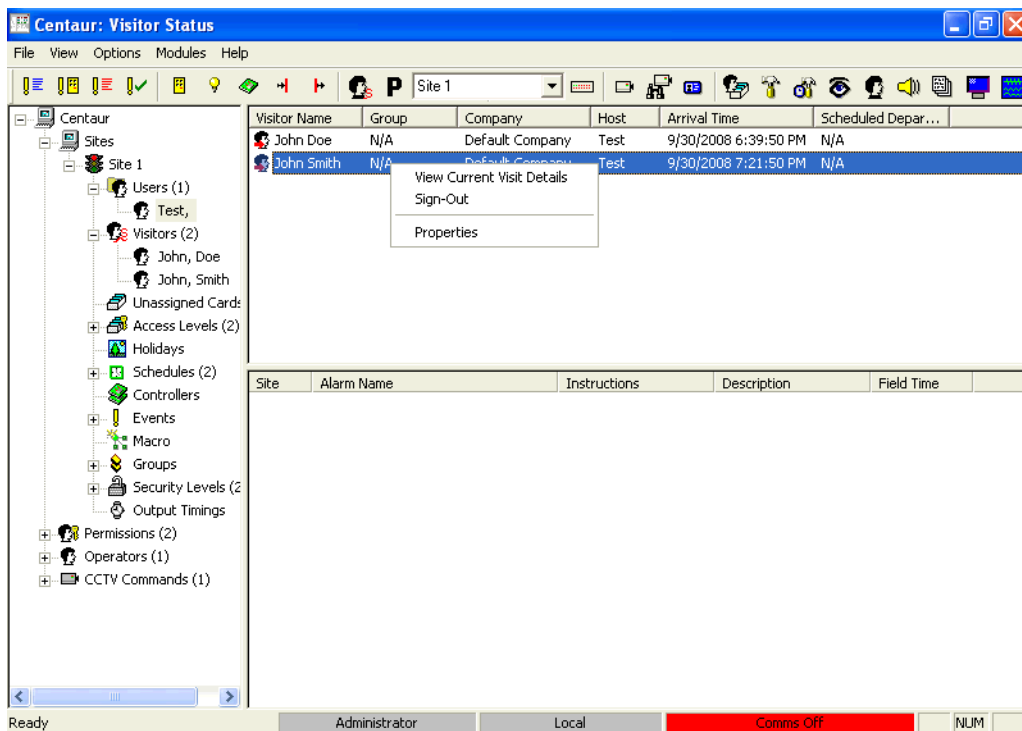

# CENTAUR

## Integrated Access Control V8.0

### Displaying Global Parking Status

**P** When you click on the **Display Global Parking Status** icon from the menu bar, Centaur will display the list of sites and user groups that have the Parking Counter option enabled. If you wish to manually allocate or free parking spaces, right-click the desired site/user group's name. A drop-down list will appear. Select one of the following actions from the list.

#### Allocate Parking Space

Allocates parking for a specific user for a specific period. Select a user from the list and select the allowed parking period (date and time). Click OK to confirm.

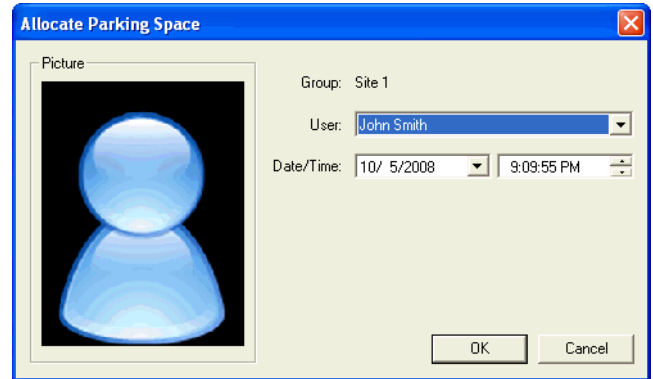

#### Reset Parking Count for Selected Group

Resets the parking counter freeing up the used places.

#### View Detailed View

Displays the list of all users currently present in the parking for the selected group.

*Display Global Parking Status*

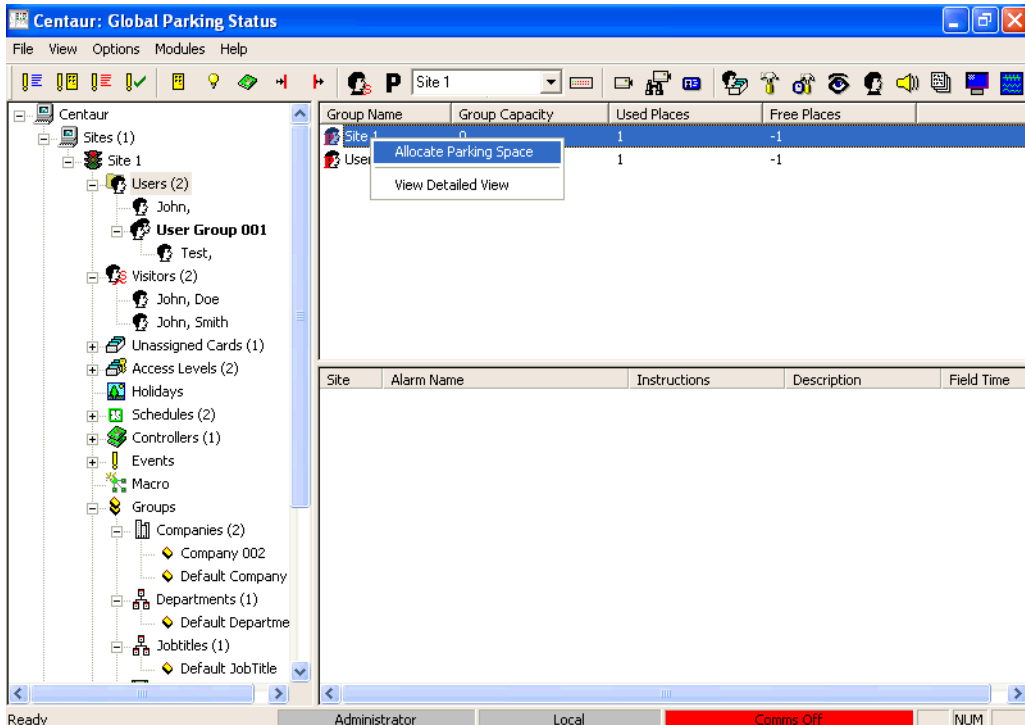

# CENTAUR

## Integrated Access Control V8.0

### Free Parking Space

To free parking space for a specific user, double on the site or user group, right-click the desired user/visitor and select **Free Parking Space**.

*Display Global Parking Status*

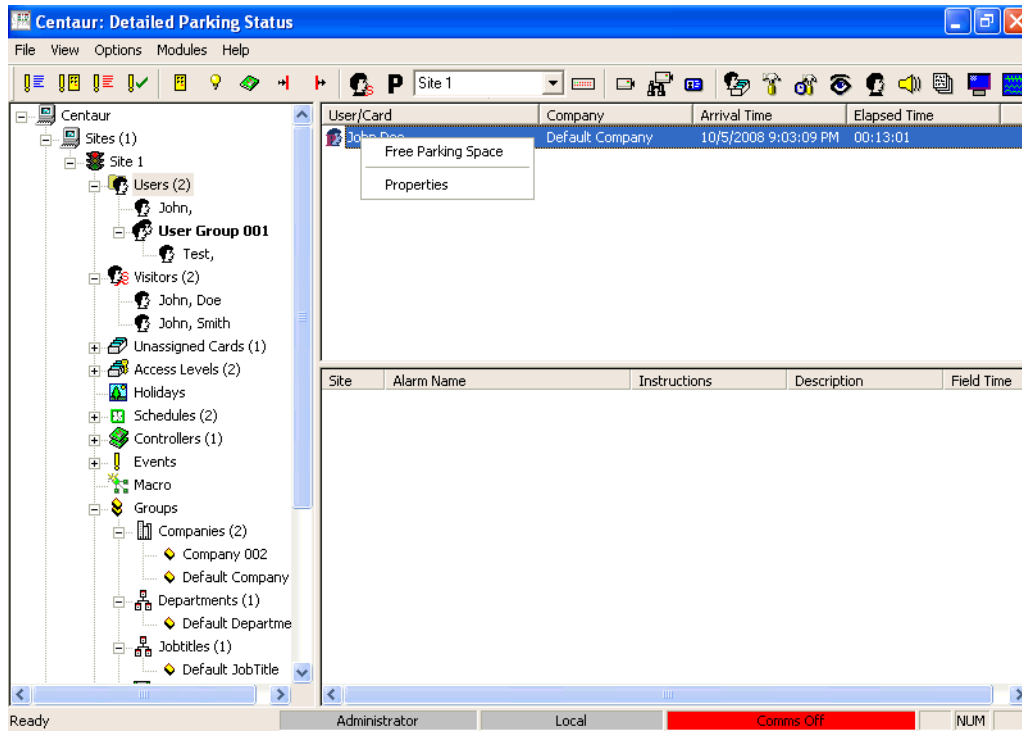

# CENTAUR

Integrated Access Control V8.0

# CENTAUR

## Integrated Access Control V8.0



## Database Management

### What Will I Find?

---

Centaur's database file management feature is automatically installed with Centaur Server. This database utility was designed to control and manage the often large and complex database files of the Centaur software. You can back up and restore database files, purge events from selected sites during specific periods, limit the size of database files and delete entire database files.

# CENTAUR

## Integrated Access Control V8.0

## WHAT ARE THE CENTAUR DATABASES?

---

Before starting, you need to understand how the Centaur databases are used and what information is saved in them. These databases are attached to the SQL Server application used by Centaur. Whenever something is programmed or an event occurs in the system, the information is downloaded to the SQL Server and saved in the Main and/or Event databases. The Main and Event databases are saved on your hard drive in the following default path C:\Program Files\CDV Americas\Centaur\Centaur Server\Data while the Pro-Report and Tracker databases are save in the path c:\Program Files\Microsoft SQL Server\MSSQL\Data. Only databases currently used by SQL and Centaur will be saved in the above-mentioned directory path. The backup files can be saved wherever you wish.

### Main Database

The Main database (Centaur3Main) contains all the system characteristics of the Centaur software (i.e. sites, controllers, schedules, cards, etc.). The more sites, cards and controllers you have programmed, the bigger this file will be.

### Event Database

The Event database (Centaur3Events) contains all events that have occurred in the system (i.e. "Access Granted", "Door Forced", alarms, etc.). For more information on how you can manage the size of the Event database, please refer to "Limiting the Event Database's Size" on page 263. Also, refer to "Disk" on page 177.

### Pro-Report Database

The Pro-Report database (Pro-Report) contains all Pro-Report configuration such as predefined report, schedule report, etc.

### Tracker Database

The Tracker database (Tracker) contains all tracker (time and attendance configuration / punches modification) access events copied from the event database.

## **DATABASE MANAGEMENT MODULE**

---

The Centaur Database Management Module is automatically installed with Centaur and can only be run on the Server. This database utility was designed to control and manage the often large and complex database files of the Centaur software. You can back up and restore database files, purge events from selected sites during specific periods, limit the size of database files and delete entire database files.

### **Starting the Database Management Module**

The Database Management Module can be started using one of two methods. To start the module from within Centaur, click the **Open Database Management Module** icon from the main menu bar. If you open the Database Management Module from within Centaur, the Restore, Attach, Detach, and Remove database options will not be available. To access all database options, run the Database Management Module as described below.

1. Make sure the SQL Server is running and that the Centaur Administration Console isn't running and the Centaur Service Manager is stopped and exit (refer to "Starting the Centaur Server and Software" on page 18).
2. Click **Start**, point to **Programs, CDV Americas, Centaur**, and click **Centaur Database Manager**.
3. From the SPXDBase Logon window, type the appropriate **Logon ID** and **Password**. Centaur's database file management utility uses the same Logon ID and Password as Centaur.

# CENTAUR

## Integrated Access Control V8.0

### Backing Up Databases

Performing a backup will save all information in the selected database(s) into a file with a .bak extension. These files can later be restored to the SQL Server application used by Centaur (see “Restoring Databases” on page 262). Also refer to “What are the Centaur Databases?” on page 259.

We highly recommend that you back up your databases regularly and that these backup files are saved on a form of removable media (i.e. tape backup, zip disk, etc.) as well as on your computer’s hard drive. This safety precaution is an important part of keeping your data safe. If for any reason a database becomes corrupt, you will be able to restore a backed up file. Creating a backup is also useful for keeping a log of events, especially if the size of the Event database is limited (see “Limiting the Event Database’s Size” on page 263), or to save as a default programming database for future applications.

1. After starting the Database Management Module as described in “Starting the Database Management Module” on page 260, the SpxDBase (Centaur Database Utility) window will appear.
2. From this window, select the **Backup** tab.
3. Select the databases you wish to back up by clicking the **Main Database**, **Event Database**, **Pro-Report Database**, and/or **Tracker Database** check boxes. For more information refer to “What are the Centaur Databases?” on page 259.
4. In the text field corresponding to the selected database(s), type the full path (location where you would like to save the backup) and desired file name. You can also click the “...” button to browse for the desired file.
5. Click the **Backup** button.

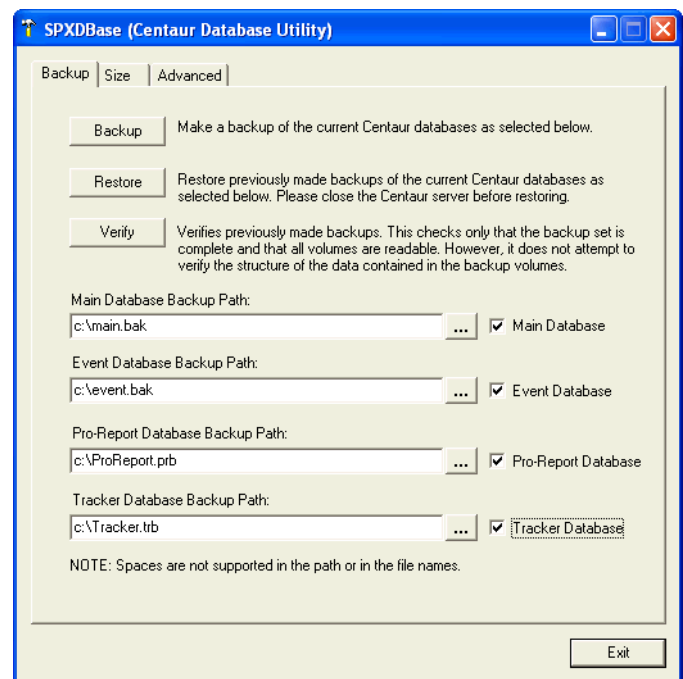

*Spaces are not supported in the path or in the file names.*

# CENTAUR

## Integrated Access Control V8.0

### Restoring Databases

Restoring databases will bring back all information saved in a backed up database file (.bak) so it can be used with the Centaur software. Performing a restoration will attach the back up files to the SQL Server application and save them in C:\Program Files\CDV Americas\Centaur\Centaur Server\Data. This will overwrite any databases currently attached.

If you are having problems with a database, or if you have experienced a loss of data, or if your database is corrupted due to a computer hardware failure, you can restore any database that you have backed up. Please note that you will have to add any programming changes that were done since the last backup was created. If events are also restored, all events that have occurred since the last backup will be lost.

1. After starting the Database Management Module as described in “Starting the Database Management Module” on page 260, the SpxDBase (Centaur Database Utility) window will appear.
2. From this window, select the **Backup** tab.
3. Select the databases you wish to restore by clicking the **Main Database**, **Event Database**, **Pro-Report Database**, and/or **Tracker Database** check boxes. For more information refer to “What are the Centaur Databases?” on page 259.
4. In the text field corresponding to the selected database(s), type the full path and the name of the file from which you want to restore the database. You can also click the “...” button to browse for the desired file.
5. Click the **Restore** button. Wait until you get the restore successful message.



# CENTAUR

## Integrated Access Control V8.0

### Limiting the Event Database's Size

With this feature, you can define the maximum size of the Event database. This feature will not affect the Main database, only the Event database (see “What are the Centaur Databases?” on page 259). When the Event database has reached its maximum size, each subsequent event will be followed by a “Failed to Process Event” event, which will appear in the Real-Time Events/Status window. At this point, events will not be saved because the database has exceeded its maximum size. You should perform a backup of the Event database (see “Backing Up Databases” on page 261), and then truncate (see “Truncating Events” below) the database to reduce its size. Perform the following to define the size of the Event database:

1. After starting the Database Management Module as described in “Starting the Database Management Module” on page 260, the SpxDBase (Centaur Database Utility) window will appear.
2. From this window, select the **Size** tab and click the **Size** button.
3. In the **Restrict growth of Event database to** text field, type the maximum size of the Event database in MB, or select the **Unlimited Growth** check box. If using MSDE, growth is limited to 2GB.



Do not select the **Unlimited Growth** check box unless the full version of SQL server is installed. Do not enter more than 1800MB when using MSDE.

4. Click **OK**.

### Truncating Events

When the Event database has reached its maximum size (see “Limiting the Event Database's Size” on page 263), each subsequent event will be followed by a “Failed to Process Event” event which will appear in the Real-Time Events/Status window. At this point, events will not be saved because the database has exceeded its maximum size. When the Event database becomes too large, you can use the Truncate feature to delete all records (including events and alarms) from the Event database. This will reduce the database file to its original size. The Truncate feature will not affect the Main database, only the Event database. Perform the following to truncate events from the Event database:



We recommend you make a backup of the database before truncating it. For more information, see “Backing Up Databases” on page 261.

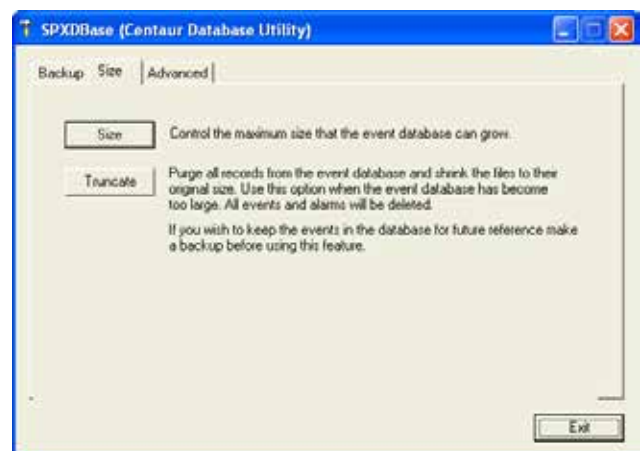

1. After starting the Database Management Module as described in “Starting the Database Management Module” on page 260, the SpxDBase (Centaur Database Utility) window will appear.
2. From this window, select the **Size** tab.
3. Click the **Truncate** button.
4. Click **Yes** to confirm the truncate action, or click **No** to cancel the truncate operation.

# CENTAUR

## Integrated Access Control V8.0

### Attaching Databases

This feature is for advanced users only and should not be used frequently. Attaching a database will tell the SQL Server application used by Centaur to begin using the databases located in C:\Program Files\CDV Americas\Centaur\Centaur Server\Data. Make sure that the Centaur3Main.mdf, Centaur3Events.mdf and the spxDBase.exe files are located in the above-mentioned path. Please note that before attaching the database, the database files currently used by Centaur need to be detached or removed (see “Detaching Databases” on page 265 or “Removing Databases” on page 265). Verify that Centaur and the Centaur Service Manager applications are closed and that the SQL Server is running. Perform the following to attach the database:

1. After starting the Database Management Module as described in “Starting the Database Management Module” on page 260, the SpxDBase (Centaur Database Utility) window will appear.
2. From this window, select the **Advanced** tab.
3. Click the **Attach** button.

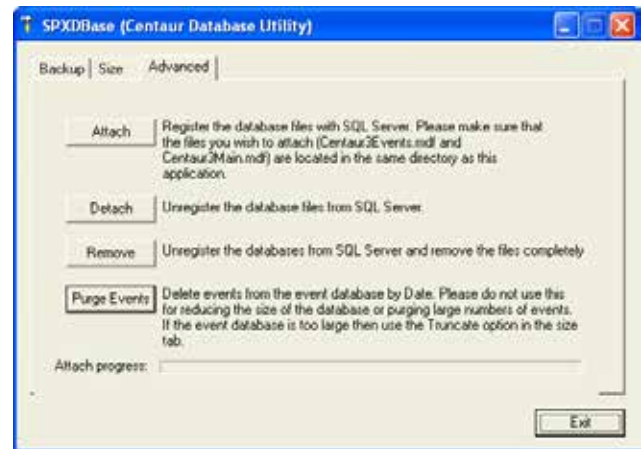

# CENTAUR

## Integrated Access Control V8.0

### Detaching Databases

This feature is for advanced users only and should not be used frequently. Before attaching a database (see “Attaching Databases” on page 264), you must tell the SQL Server application used by Centaur to stop using the current databases by detaching them. Detaching the database will allow you to keep a manual backup of the current databases. If you perform a detachment, the databases will be detached from SQL, but will still exist. You must move them from the current path C:\Program Files\CDV Americas\Centaur\Centaur Server\Data to another path. Perform the following to detach the database:

1. After starting the Database Management Module as described in “Starting the Database Management Module” on page 260, the SpxDBase (Centaur Database Utility) window will appear.
2. From this window, select the **Advanced** tab.
3. Click the **Detach** button.

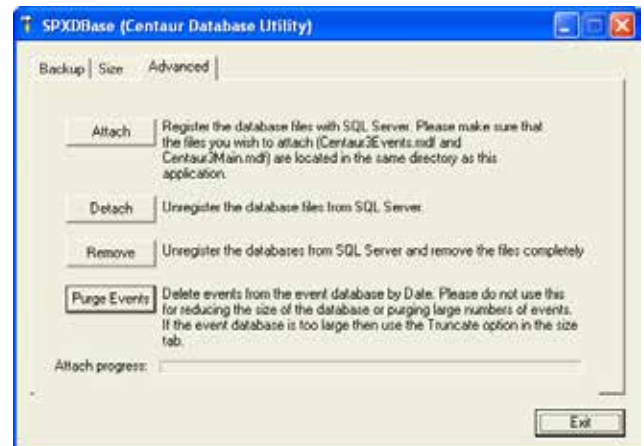

### Removing Databases

If you remove the databases, it will detach the database and delete it completely. You will not be able to restore or re-attach databases that have been removed. Perform the following to remove the database:

1. After starting the Database Management Module as described in “Starting the Database Management Module” on page 260, the SpxDBase (Centaur Database Utility) window will appear.
2. From this window, select the **Advanced** tab.
3. Click the **Remove** button.

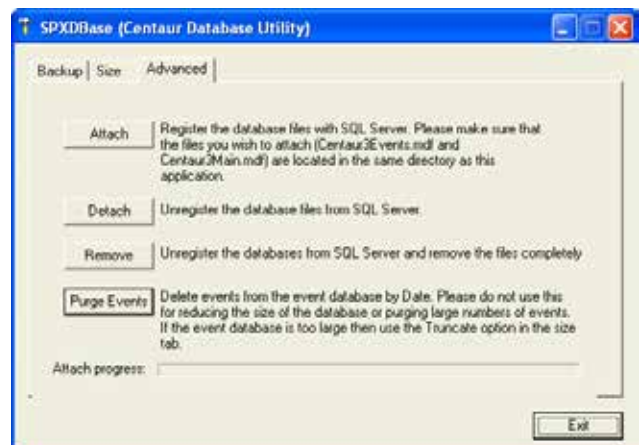

# CENTAUR

## Integrated Access Control V8.0

### Purging Databases

Using this feature, you can delete events that occurred between a specified period of time and within a selected site or within all sites. The purge feature will not affect the Main database, only the Event database. Perform the following to purge events from the Event database:



*Do not use the purge feature to reduce the size of the database or to delete large numbers of events. Instead, use the Truncate feature (see "Truncating Events" on page 263). Also, any alarms that require acknowledgement (see "Alarm Acknowledgement" on page 180 that have not been acknowledged will not be deleted.*

1. After starting the Database Management Module as described in "Starting the Database Management Module" on page 260, the SpxDBase (Centaur Database Utility) window will appear.
2. From this window, select the **Advanced** tab and click the **Purge Events** button.
3. From the Purge Events window, use the **Start Date** and **End Date** drop-down lists to select the period.
4. Select the site from the **Site** drop down list or click the **All Sites** check box.
5. Click **OK**. Centaur will delete events that occurred in the selected site(s) during the selected period.

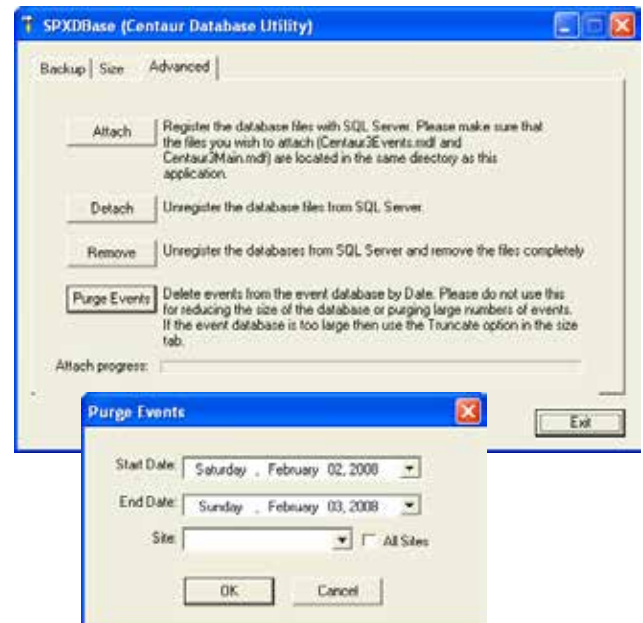

# CENTAUR

## Integrated Access Control V8.0

### DATABASE BACKUP SCHEDULER

Centaur's database backup scheduler enables you to schedule regular backups of the Centaur databases. You can back up the Main database and the Event database separately, specify the location of the backup files and select how often (daily, weekly, or monthly) the backup will occur.



**When the database backup scheduler saves the backup file, it will overwrite the previous file. If you want to create backup files that do not overwrite each other, refer to the document from the c:\Program Files\CDV Americas\Centaur\Administration Console\MSDE Management\MSDE\_How to create a schedule task.doc or contact technical support (see "Free Technical Support" on page 11).**

### Creating a Scheduled Database Backup

Multiple scheduled jobs can be created to save database backups in different locations, with different names and using different schedules. Perform the following to run Centaur's database backup scheduler and create scheduled job:

1. Make sure the SQL Server is running (see "Starting the Centaur Server and Software" on page 18).

2. Click **Start, Programs, CDV Americas, Centaur, Administration Console**, and click **MSDE Management Console**, or directly from within Centaur, click the **Open Database Backup Scheduler** icon from the main menu bar. Choose the language from the pop-up window, click **OK**, and the MSDE Management Console window will appear.



3. Click the **Schedule backup** button from the main menu bar. The Create Database Backup Wizard window will appear.
4. Click **Next**.
5. From the **Database** drop-down list, select the database you would like to backup. For more information, refer to "What are the Centaur Databases?" on page 259. Click **Next**.
6. In the **Name** text box, type the job name of the scheduled backup. In the **Description** text box, type the description of the backup. Click **Next**.
7. In the **Select backup file** text field, type the full path (location where you would like to save the backup) and the desired file name. You can also click the "..." button to browse for the desired path and/or file. Click **Next**.
8. Select **Create a scheduled job to be performed periodically**. A text field will appear indicating the current schedule. Click the **Change** button to change the schedule and click **OK**. After changing the schedule, and click **Next**.
9. Click **Finish**.

# CENTAUR

## Integrated Access Control V8.0

### Editing a Scheduled Database Backup

You cannot edit a scheduled job. If you need to change the scheduled job's settings, you must delete the existing job (see "Deleting a Scheduled Database Backup" below) and then re-create a new one (see "Creating a Scheduled Database Backup" on page 267).

### Deleting a Scheduled Database Backup

Perform the following to delete a scheduled job:

1. Make sure the SQL Server is running (see "Starting the Centaur Server and Software" on page 18).
2. Click **Start, Programs, CDV Americas, Centaur**, and click **MSDE Management Console**, or directly from within Centaur, click the **Open Database Backup Scheduler** icon from the main menu bar. The MSDE Management Console window will appear.
3. From the Database Tree View window (left-hand portion of your screen), double-click the **Jobs** branch.
4. From the Details window (right-hand portion of your screen), right-click the desired job and click **Delete job**. A dialogue box will appear requesting confirmation.

# CENTAUR

Integrated Access Control V8.0

# CENTAUR

## Integrated Access Control V8.0



## Centaur Wave Player

### What Will I Find?

---

This utility was designed to enable a .wav file to be played on the computer when an event that requires acknowledgement occurs. The sound can replay at programmed intervals until the alarm is acknowledged.

# CENTAUR

## Integrated Access Control V8.0

### CENTAUR WAVE PLAYER

This utility was designed to enable a .wav file to be played on the computer when an event that requires acknowledgement occurs (see “Alarm Acknowledgement” on page 166). The sound can replay at programmed intervals until the alarm is acknowledged.

#### Starting Centaur Wave Player

1. Make sure that Centaur is running. Click **Start, Programs, CDV Americas, Centaur, Administration Console**, and click **WavePlayer**.
2. From the Wave Player Login window, type the appropriate **Login ID** and **Password**. Centaur Wave player uses the same Login ID and Password as Centaur. If you are trying to log in to a Centaur Server that is on a network, type the computer's network name or IP address in the **Computer** text field.
3. Click **OK**.

#### Assigning a WAV File

When an event that requires acknowledgement occurs and it has been assigned a .wav file as detailed below, the associated sound will play. The event that occurs will also appear in Centaur Wave player Real-Time Events/Status window until the alarm is acknowledged (refer to “Alarm Acknowledgement” on page 166 for more information). If the alarm event is not acknowledged, the sound will replay every 1 to 60 minutes depending on the set value.



*The .wav file will only play if the selected event has been set as an alarm in Centaur. The event's alarm acknowledgement feature must be enabled (refer to “Alarm Acknowledgement” on page 166 for more information).*

1. Start Centaur Wave player as detailed in “Starting Centaur Wave Player”.
2. From the main menu bar, select **File** and click **Settings**. The Wave Player Settings window appears.
3. In the **Repeat Sound Every** text field, type a value between 1 and 60 minutes. This value applies to all events with an associated .wav file.
4. In the Event Definition list, double-click the event you wish to assign a .wav file to. The **Select Wav** file path window appears.
5. Click the “...” button and select the .wav file and location. Click **OK**.
6. Repeat these steps to assign further .wav files to events. Click **Apply**.

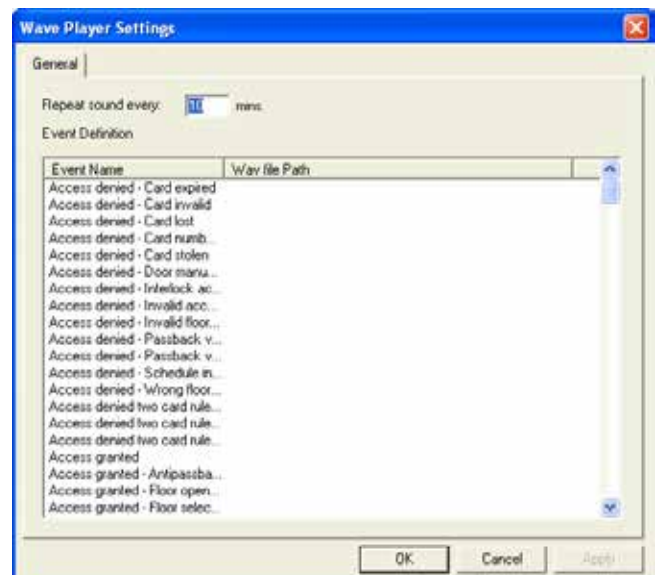

# CENTAUR

## Integrated Access Control V8.0



## DCOM Configuration

### What Will I Find?

---

DCOM Configuration for Windows Vista .....	251
DCOM Configuration for Windows XP .....	271
DCOM Configuration for Windows 2003 Server.....	289
DCOM Configuration for Windows 2000 Pro and Server .....	314

Centaur uses Distributed Component Object Model (DCOM) to communicate between its software components. DCOM is a protocol that enables software components to communicate directly across multiple network transports, including Internet protocols such as HTTP, in a reliable, secure, and efficient manner.

It is necessary to configure the DCOM only when operators need to access the Centaur Server computer from remote computers. DCOM configuration is performed on the Centaur Server computer only and sets Windows to allow access from remote workstations creating Windows user accounts.

Before configuring the DCOM, the Centaur Server must be installed (refer to "Installation Overview" on page 10) and the users that will access the Centaur Server must be programmed in the server. The DCOM Configuration Utility is automatically installed with Windows 2000/2003/XP/Vista operating systems. We recommend this settings to be done by a network administrator.

# CENTAUR

## Integrated Access Control V8.0

## DCOM CONFIGURATION FOR WINDOWS VISTA

To be able to configure the DCOM on Windows Vista operating system, you have to be logged in as Administrator.

### Verifying DCOM

Before going on with the DCOM configuration, you can perform the following steps to verify the integrity of your DCOM:

1. From the taskbar, click **Window** icon -> in the **Search** field type **dcomcnfg.exe** in the text box and then click **OK**.



2. The **Component Services** window will appear. Within the **Console Root** folder (left side of your screen), expand the **Component Services** branch, the **Computers** branch, and then the **My Computer** branch. Ensure that the **Running Processes** folder appears in the **My Computer** branch. If it does not appear, you must repair DCOM (see below).

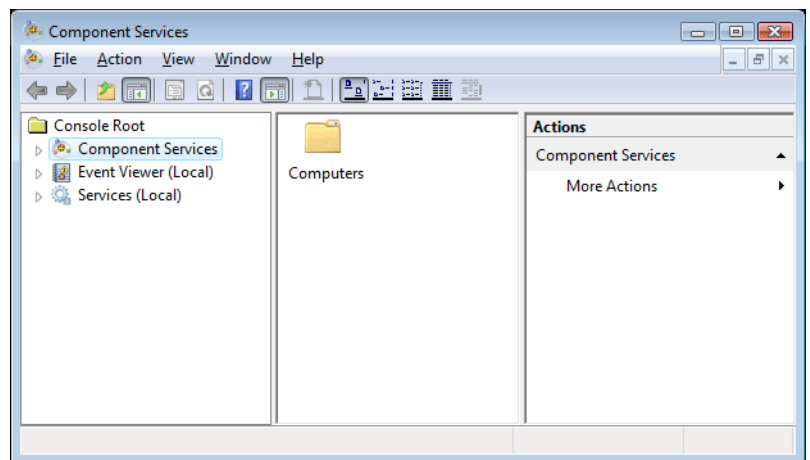

3. Click the **COM+ Applications** branch. The components of this branch will appear on the right of your screen. If you get an error message and/or cannot access this branch of components, you must repair DCOM (see below).

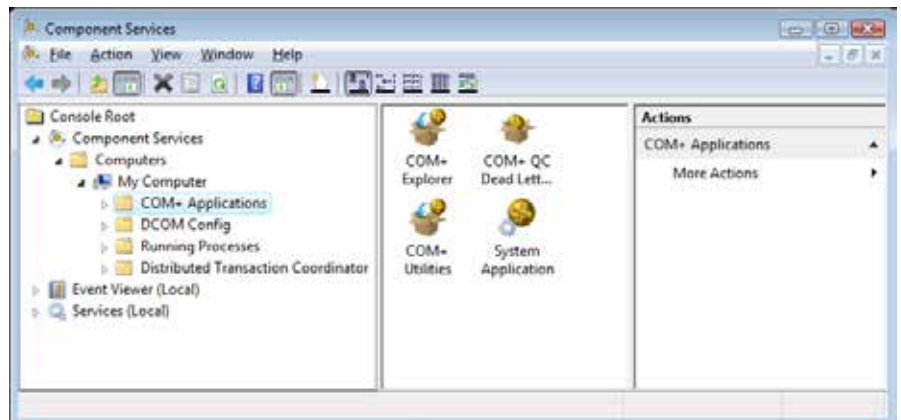

If your DCOM configuration is found corrupted then follow the steps below; if not, skip the next section and go directly to "Setting the firewall" section.

# CENTAUR

## Integrated Access Control V8.0

### Repairing DCOM

Perform the following steps to repair your DCOM configuration:

1. From the taskbar, click **Window** Icon-> in the **Search** field type **cmd** in the text box and then press **Enter**.



2. The **C:\WINDOWS\System32\cmd.exe** window will appear. Type **cd %systemroot%\system32** and press the keyboard **Enter** key. Then, type **msdtc -uninstall\_** and press the keyboard **Enter** key.

A screenshot of a Windows command prompt window. The title bar reads 'C:\Windows\system32\cmd.exe'. The text inside the window shows the following commands and their output:

```
Microsoft Windows [Version 6.0.6001]
Copyright (c) 2006 Microsoft Corporation. All rights reserved.

C:\Users\Thecnical support>cd %systemroot%\system32
C:\Windows\System32>msdtc -uninstall_
```

3. Reboot your computer.
4. From the taskbar, click **Start -> Run**. The **Run** window will appear. Enter **cmd** in the text box and then press **Enter**.



5. The **C:\WINDOWS\System32\cmd.exe** window will appear. Type **cd %systemroot%\system32** and press the keyboard **Enter** key. Then, type **msdtc -install\_** and press the keyboard **Enter** key.

A screenshot of a Windows command prompt window. The title bar reads 'C:\Windows\system32\cmd.exe'. The text inside the window shows the following commands and their output:

```
Microsoft Windows [Version 6.0.6001]
Copyright (c) 2006 Microsoft Corporation. All rights reserved.

C:\Users\Thecnical support>cd %systemroot%\system32
C:\Windows\System32>msdtc -install_
```

# CENTAUR

## Integrated Access Control V8.0

### Verifying if the DCOM has been repaired

Perform the following steps to verify that DCOM has been repaired:

1. From the taskbar, click **Window** icon -> in the **Search** field type **dcomcnfg** in the text box and then press **Enter**.
2. The **Component Services** window will appear. In the Console Root folder (left side of your screen), expand the **Component Services** branch, the **Computers** branch, and then the **My Computer** branch. If there is a red arrow next to any of the components of this folder, DCOM has not been successfully repaired and you must repeat the repairing process.

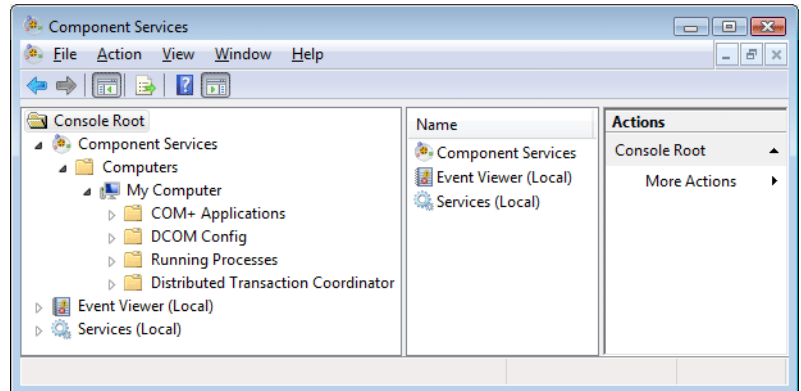

### Setting the Firewall

Firewall settings need to be altered on the Centaur Server computer and on any workstation connecting to the Centaur Server computer through DCOM.

In your firewall you need to:

Open the **port 135** (DCOM port)

Allow access (in Inbound and Outbound) for the program **SPXSVR.exe** found on C:\Program Files\CDV Americas\Centaur\Centaur Server on BOTH workstation and server.

On the server only you need to allow access (in Inbound and Outbound) for the program **sqlsevr.exe** found on C:\Program Files\Microsoft SQL Server\MSSQL\Binn\.

Please refer to your firewall documentation if you need help. If you are using the Windows firewall follow these steps to alter your settings:

1. From the taskbar, click **Windows** icon -> **Control Panel**.

# CENTAUR

## Integrated Access Control V8.0

- The Control Panel window will appear. Double-click on the **Allow a program through Windows Firewall**.



- The **Windows Firewall** settings window will appear. From the **Exceptions** tab, click **Add Port**.

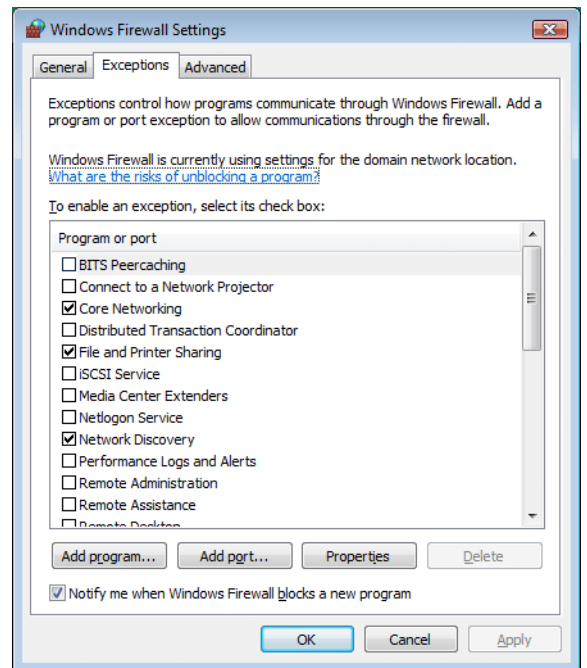

# CENTAUR

## Integrated Access Control V8.0

- The **Add a Port** window will appear. In the **Name** field, enter **DCOM**. In the **Port number** field, enter **135**. Select **TCP** as your Protocol type and then click **OK**.

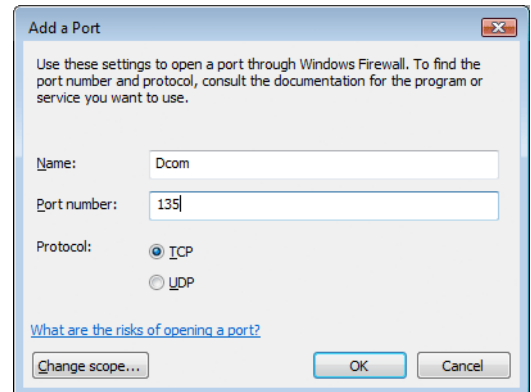

- The **Windows Firewall** settings window will re-appear. From the **Exceptions** tab, make sure that the **DCOM** checkbox below the **Program or port** section is checked.

If you are configuring/repairing the firewall settings on a workstation connected to the Centaur Server computer, click **OK**.

If you are repairing your firewall settings on the Centaur Server computer, go to the next step.

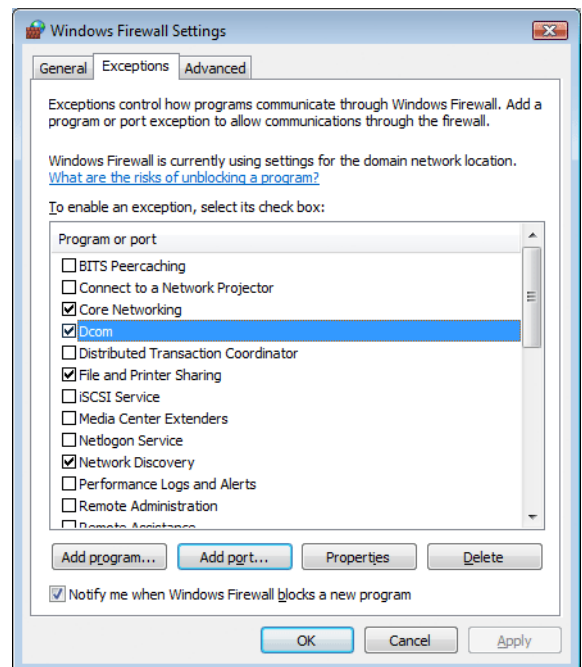

# CENTAUR

## Integrated Access Control V8.0

6. From the **Exceptions** tab, click **Add Program**.
7. The **Add a Program** window will appear. Click **Browse...** and select the **spxsvr.exe** file (located by default in C:\Program Files\CDV Americas\Centaur\Centaur Server) and then click **OK**.

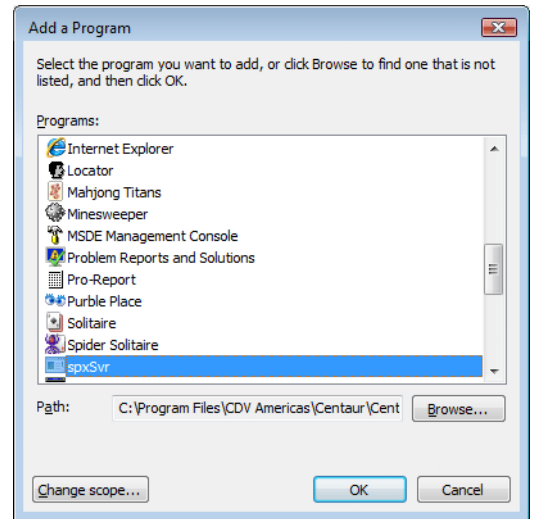

8. The **Windows Firewall** settings window will re-appear. From the **Exceptions** tab, make sure that the **spxsvr.exe** checkbox below the **Programs or Port** heading is checked.
9. From the **Exceptions** tab, click **Add Program**.

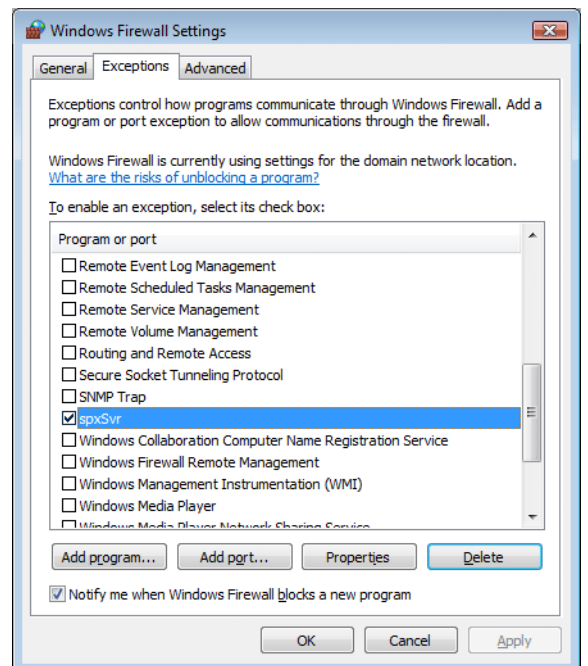

# CENTAUR

## Integrated Access Control V8.0

- The **Add a Program** window will appear. Click **Browse...** and select the **sqlsevr.exe** file (located by default in C:\Program Files\Microsoft SQL Server\MSSQL\Binn\ ) and then click **OK**.

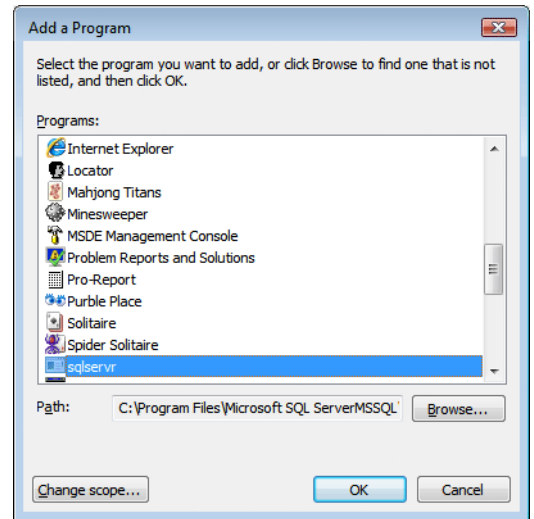

- The **Windows Firewall** settings window will re-appear. From the **Exceptions** tab, make sure that the **sqlsevr.exe** checkbox below the **Programs or Port** heading is checked.

- Click **OK**.

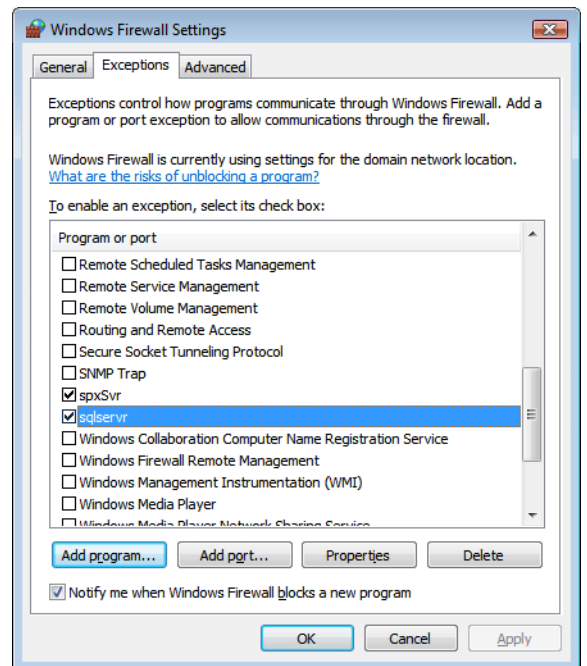

# CENTAUR

## Integrated Access Control V8.0

### Configuring DCOM on Windows Vista

Follow these steps to enable the Network discovery and File sharing on the server and the workstation.

1. Click on the **Windows** icon, right click on **Network** and select **Properties**.

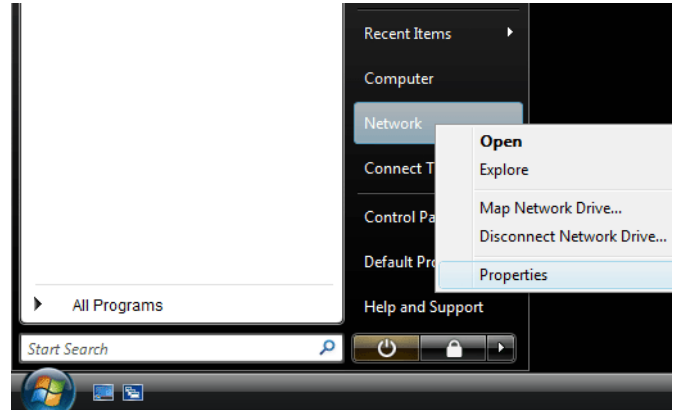

2. Set the **Network discovery** and **File Sharing** are **ON**. Click on the arrow to set to **ON**.

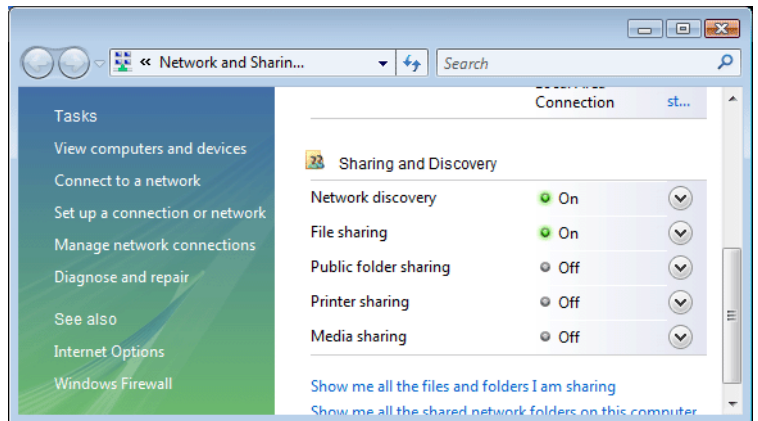

3. From the taskbar, click **Windows** icon then right click on **Computer** and select **Manage**.

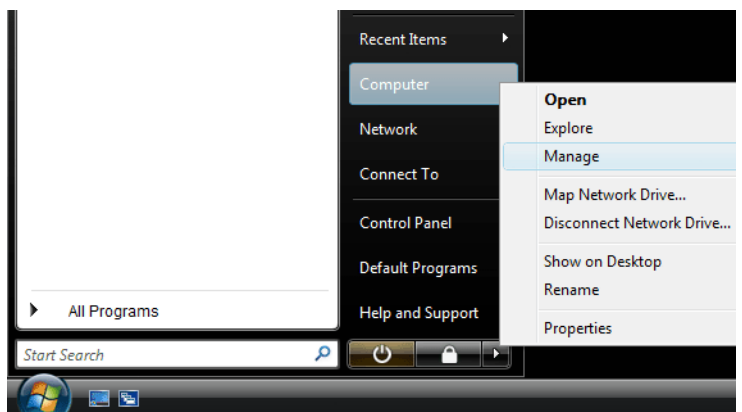

# CENTAUR

## Integrated Access Control V8.0

- The **Computer Management** window will appear. Expand **System Tools** and expand **Local Users and Groups**.

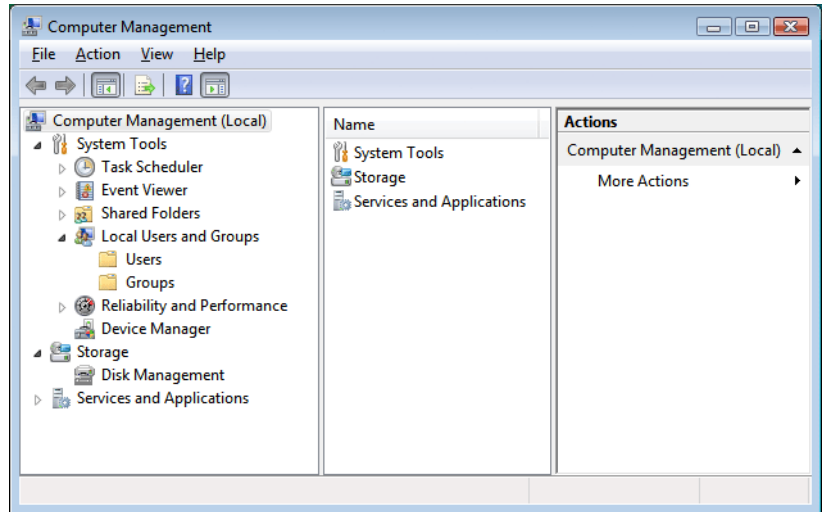

- Right click on the **Groups** and select **New Group** to create the Centaur group that will be used for DCOM.'

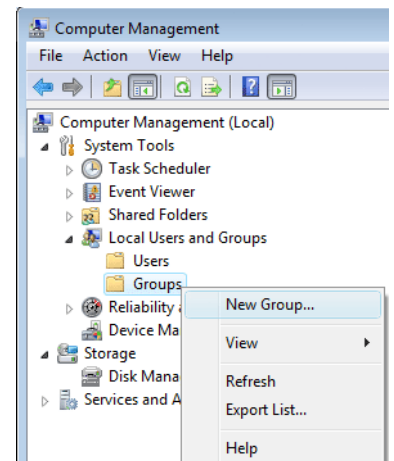

- In the **Group Name** field type **Centaur Group**. Click on the **Add...** button.

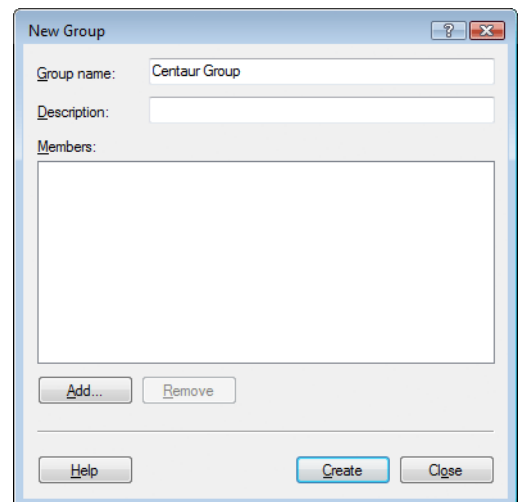

# CENTAUR

## Integrated Access Control V8.0

- The window **Select Users** pops-up.  
Click on **Advanced...** button.

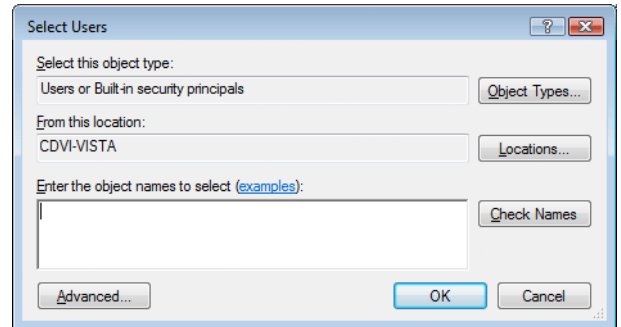

- Check if the **Object Types ...** and **Locations ...** are properly set then click on the **Find Now** button. Select from the list the users you want to access the Server. For a multiple selection, keep pressed the Ctrl key while selecting the names from the list. Click **OK**.

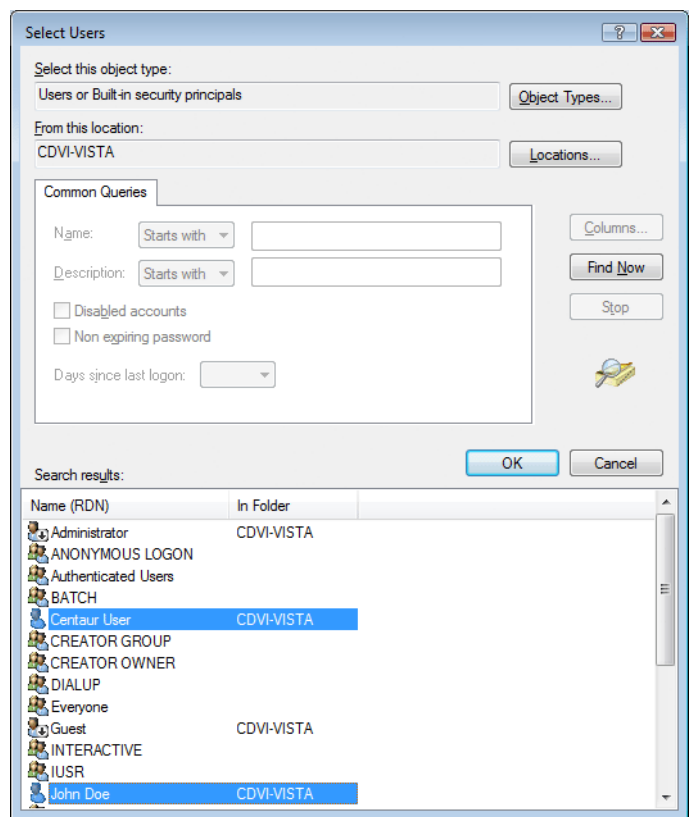

- The selected users will appear in the **Select Users**, under the **Enter the object names to select (examples)** section. Click **OK**.

- Click **Close**.

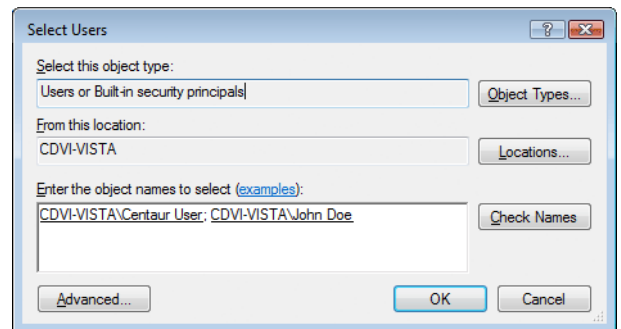

# CENTAUR

## Integrated Access Control V8.0

- From the **computer management** window, under Groups, double-click on the group named **Distributed COM Users**.

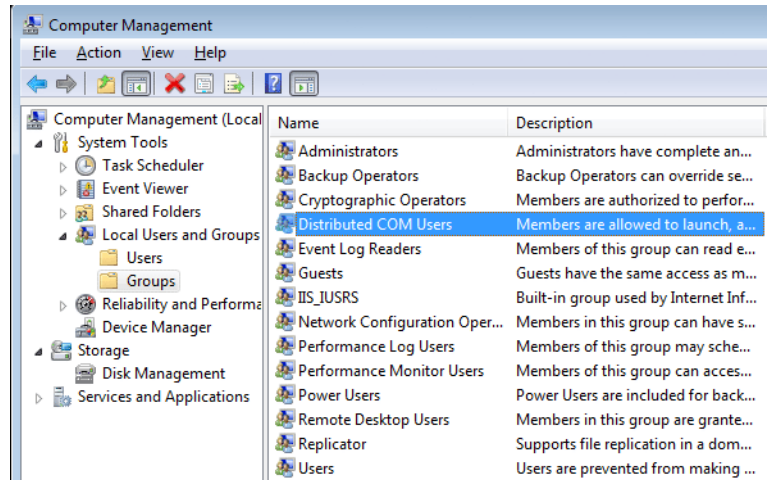

- Click on the **Add** button then add the Centaur group.
- Click **OK**.

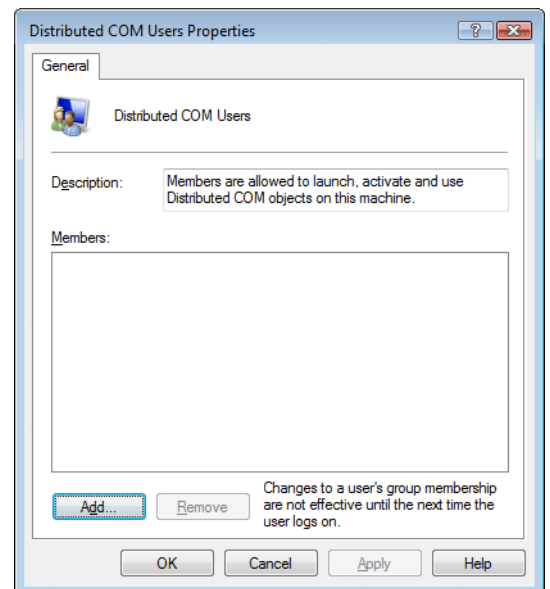

- From the taskbar, click **Window** icon -> in the **Search** field type **dcomcnfg.exe** in the text box and then press **Enter**.



# CENTAUR

## Integrated Access Control V8.0

- The **Component Services** window will appear. Expand the **Component Services**, **Computers** and **My Computer** branches, then click **DCOM Config**.

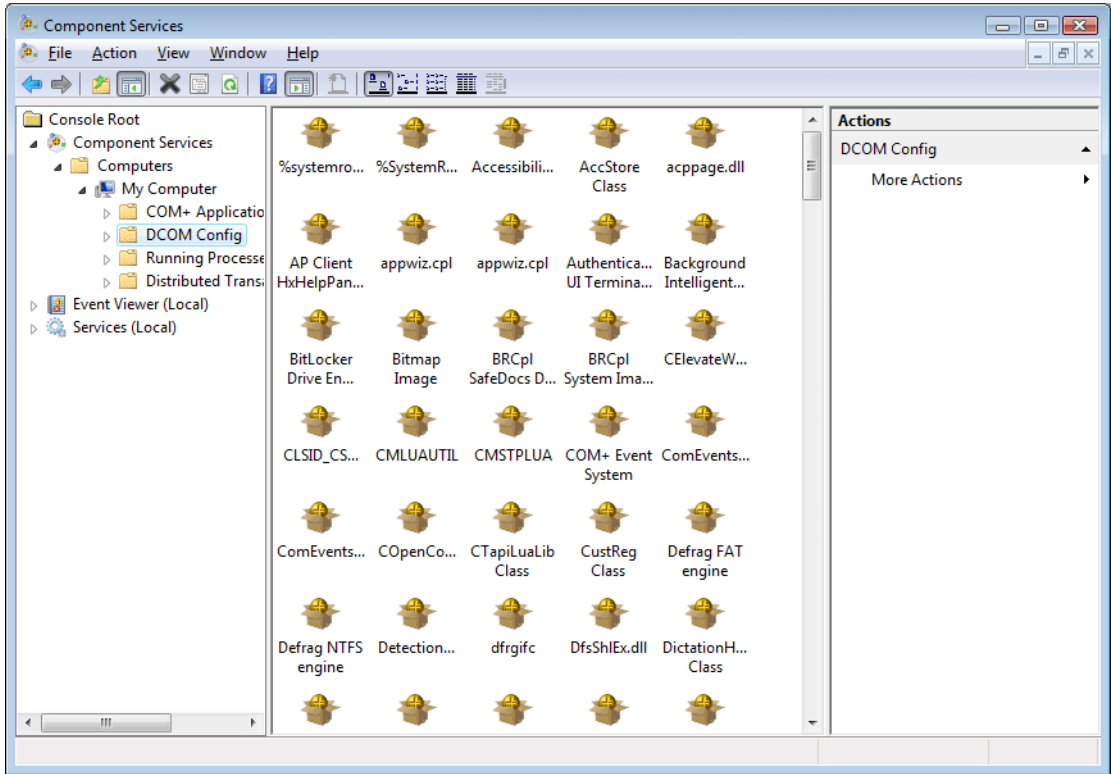

# CENTAUR

## Integrated Access Control V8.0

16. Right-click the **SpxSvr** file then click **Properties**.

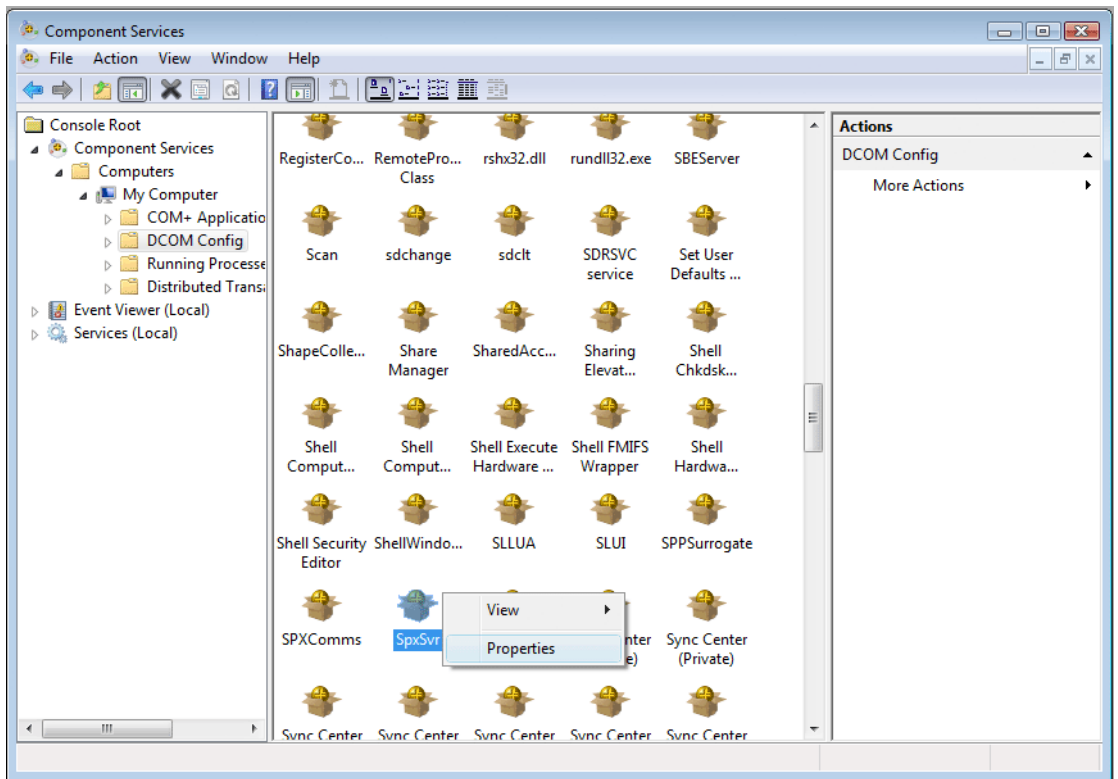

17. The **SpxSvr Properties** window will appear.  
From the **Authentication Level** drop-down list, select **(None)**.

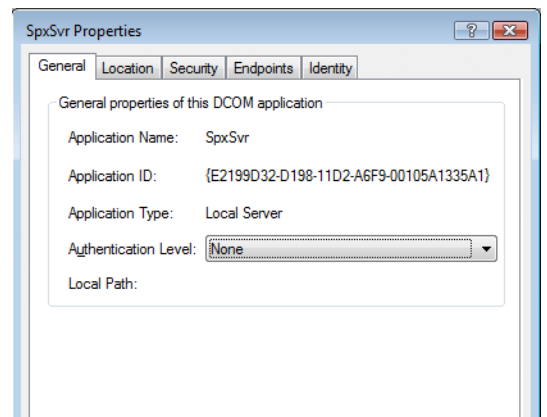

# CENTAUR

## Integrated Access Control V8.0

18. Click the **Location** tab and select the **Run application on this computer** check box.

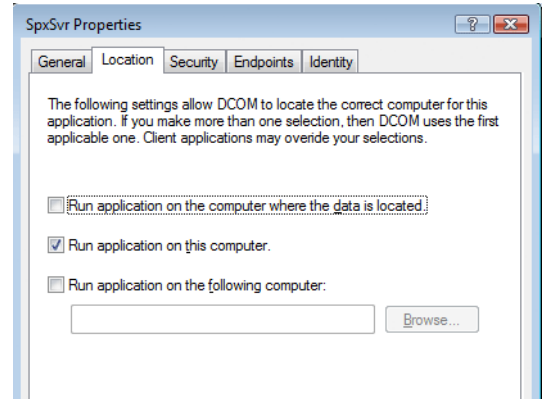

19. Click the **Identity** tab and then select **The interactive user** check box.

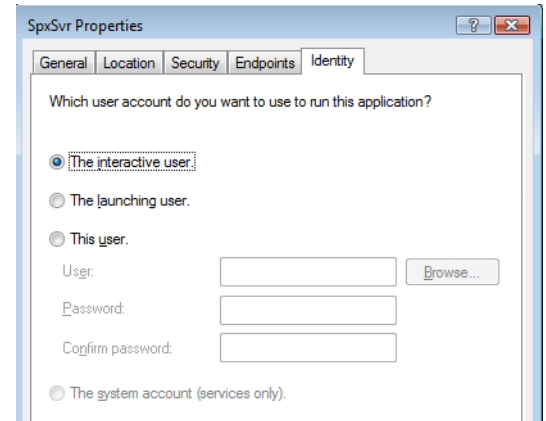

20. Click the **Security** tab to configure the user that will have the right to access the Centaur Server.

- Under **Launch and Activation Permission**, click **Customize**.
- Under **Access Permissions**, click **Customize**.
- Under **Configuration Permissions**, click **Use Default**.

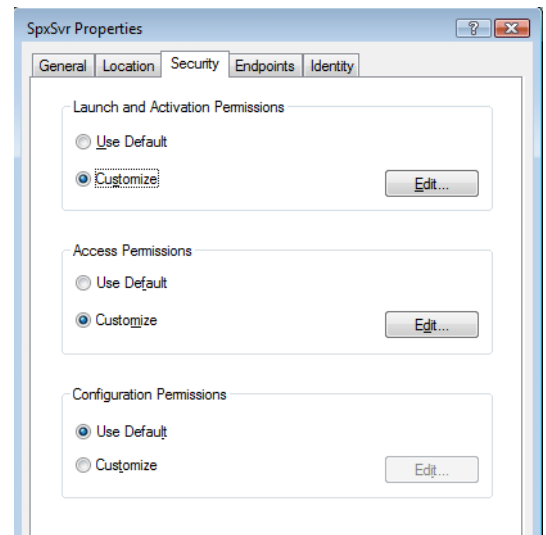

# CENTAUR

## Integrated Access Control V8.0

21. Under **Launch and Activation Permission**, click the **Edit** button.
22. The **Launch and Activation Permission** window will appear.  
Click the **Add** button to add the Centaur Group.

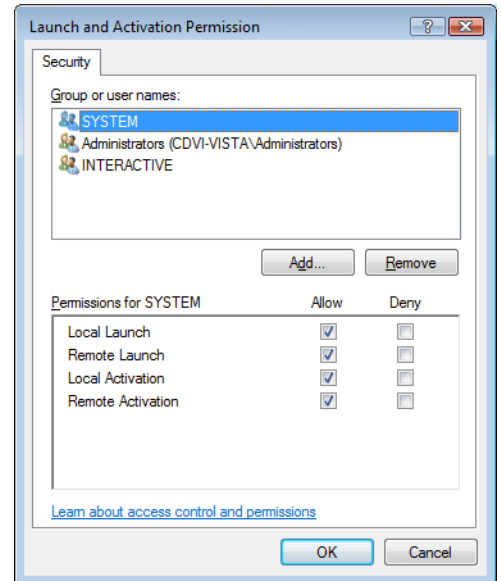

23. Check if the **Object Types ...** and **Locations ...** are properly set then click on the **Find Now** button. Select from the list the **Centaur Group**, previously created. For a multiple selection, keep pressed the Ctrl key while selecting the names from the list. Click **OK**.

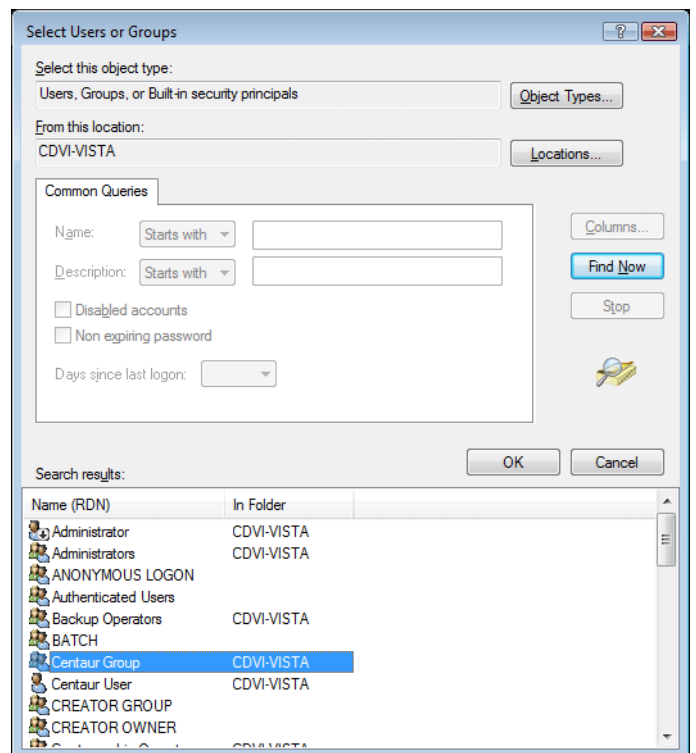

# CENTAUR

## Integrated Access Control V8.0

24. The Centaur Group appear in the **Select Users**, under the **Enter** **OK**.



25. Select **Centaur group** then check the check box **Allow to Local Launch, Remote Launch, Local Activations and Remote Activations**. Click **OK**.

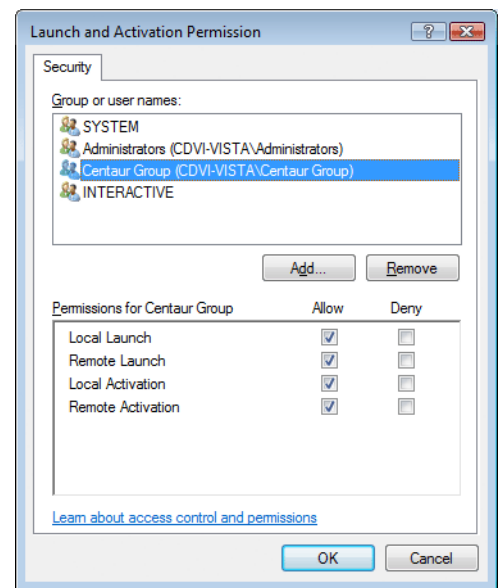

26. Under **Access Permissions**, click the **Edit** button.

27. The **Access Permissions** window will appear. Click the **Add** button to add The Centaur group.

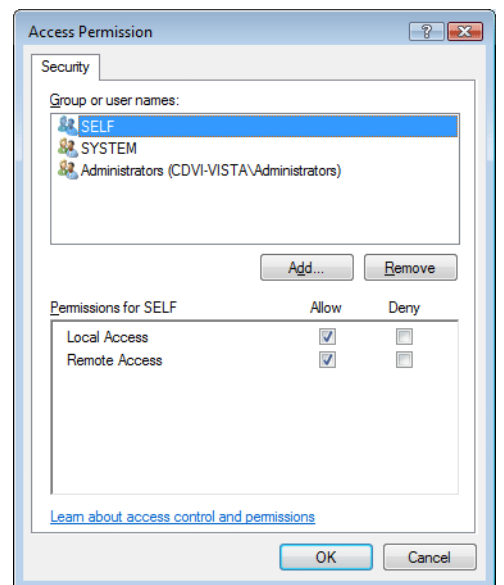

# CENTAUR

## Integrated Access Control V8.0

28. Check if the **Object Types ...** and **Locations ...** are pro the **Centaur Group**, previously created. For a multiple selection, keep pressed the Ctrl key while selecting the names from the list. Click **OK**.

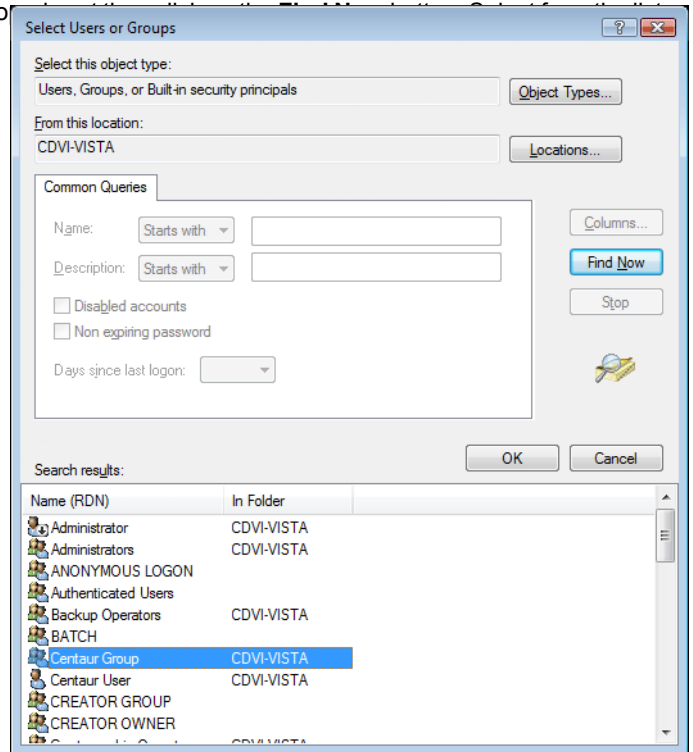

29. The Centaur Group appear in the **Select Users**, under the **Enter the object names to select (examples)** section. Click **OK**.

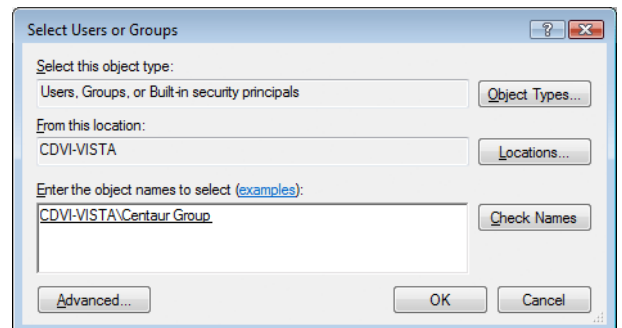

# CENTAUR

## Integrated Access Control V8.0

30. Check the check box **Allow to Local Access** and **Remote Access**. Click **OK**.
31. Click **OK**, to close the SPXSVR.exe properties and close the **Component services** window.

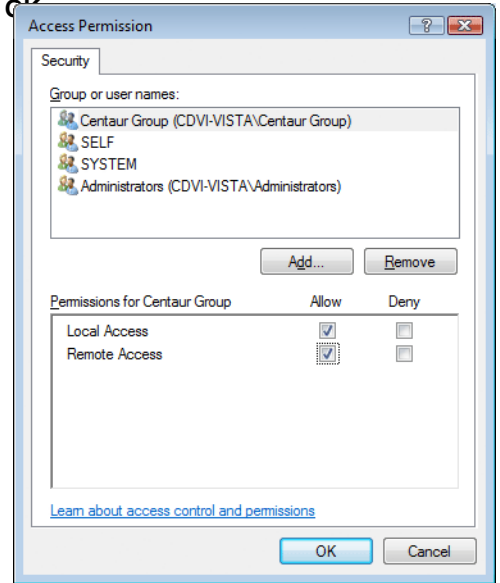

32. From the taskbar, click **Window** icon -> in the **Search** field type **administrative tools** in the text box and then press **Enter**.
33. The administrative tools window appear. Double click on the **Local security policies**.

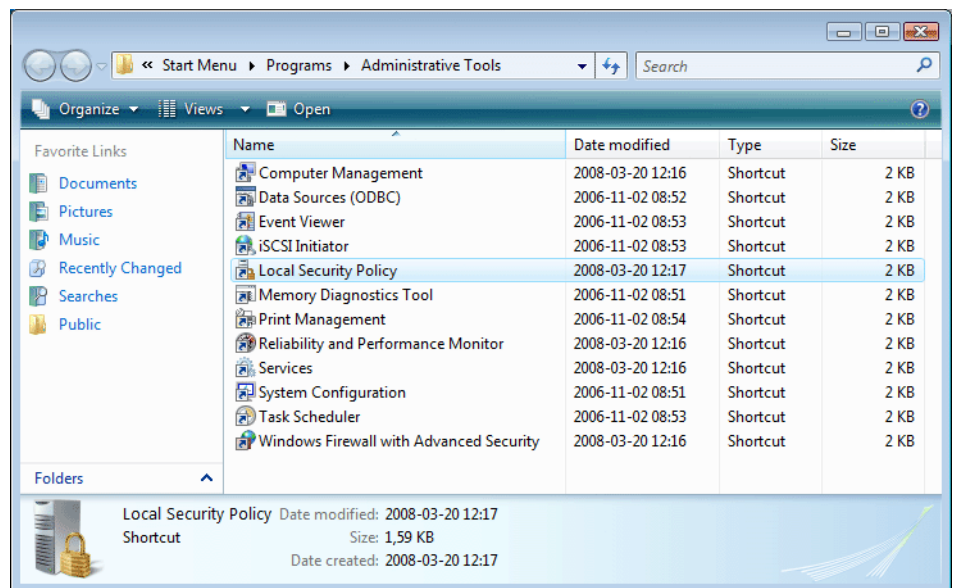

# CENTAUR

## Integrated Access Control V8.0

34. The **Local Security Settings** window will appear. Double Click on **Local policies** then select **Security options**.

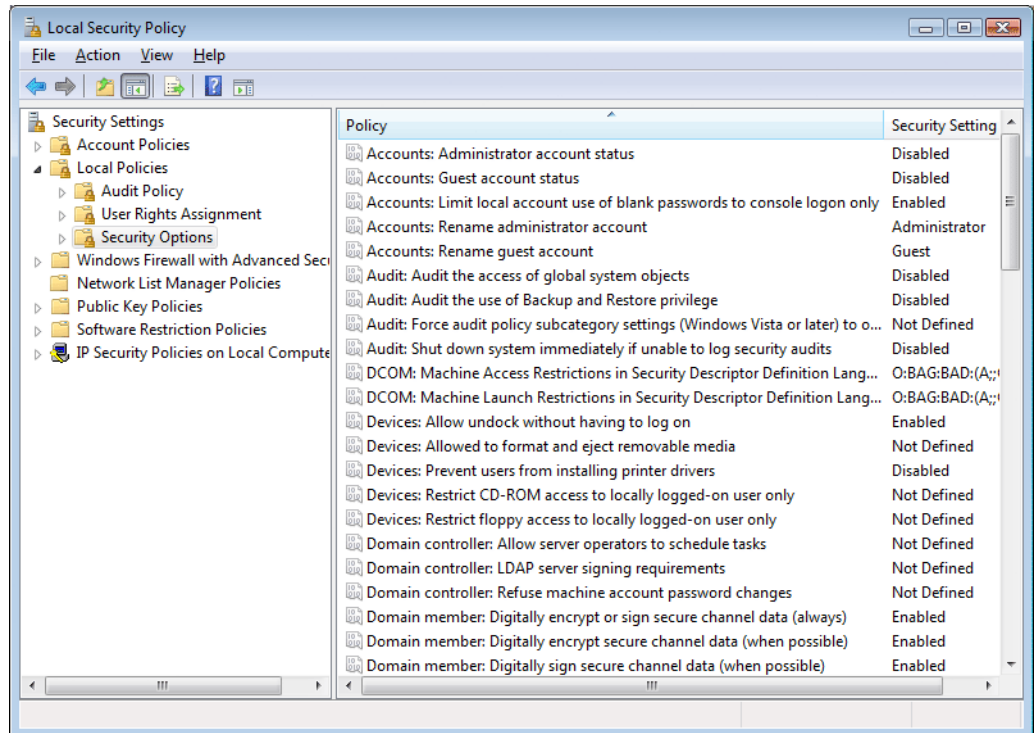

35. Double-click **Network Access: Sharing and security model for local account**.

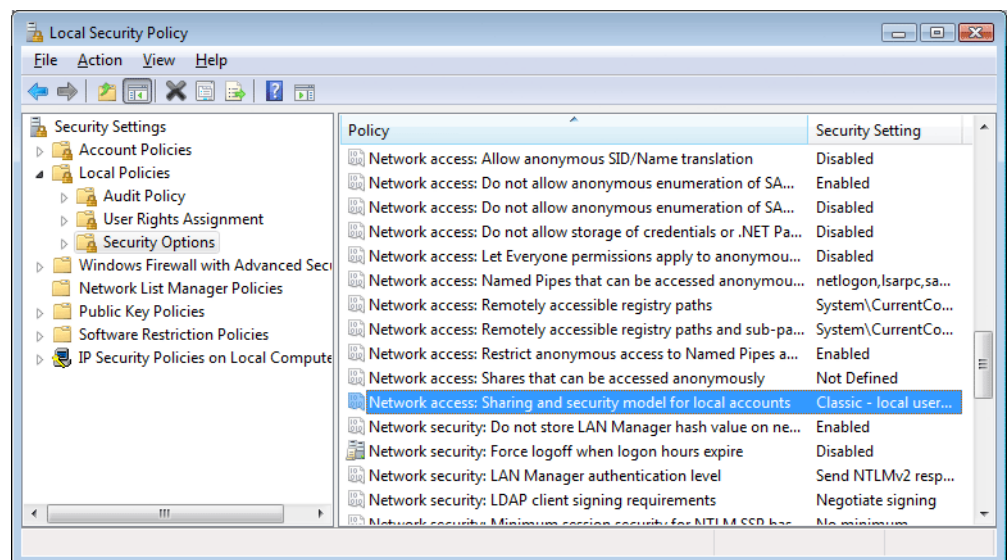

# CENTAUR

## Integrated Access Control V8.0

36. The **Network Access: Sharing and security model for local accounts** window will appear. From the drop-down list, click on **Classic - local users authenticate as themselves** and then click **Ok**.

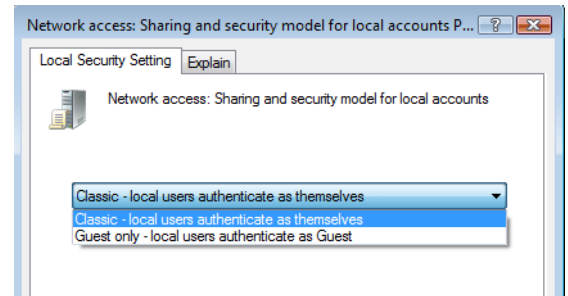

# CENTAUR Integrated Access Control V8.0

## DCOM CONFIGURATION FOR WINDOWS XP

To be able to configure the DCOM on Windows XP operating system, you have to be logged in as Administrator.

### Verifying DCOM

Before going on with the DCOM configuration, you can perform the following steps to verify the integrity of your DCOM:

1. From the taskbar, click **Start -> Run**. The **Run** window will appear. Enter **dcomcnfg.exe** in the text box and click **OK**.

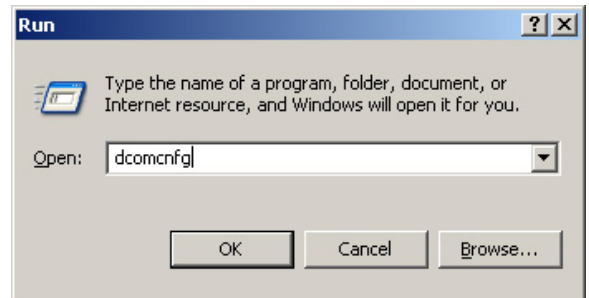

2. The **Component Services** window will appear. Within the **Console Root** folder (left side of your screen), expand the **Component Services** branch, the **Computers** branch, and the **My Computer** branch. Ensure that the **Running Processes** folder appears in the **My Computer** branch. If it does not appear, you must repair DCOM. If your DCOM configuration is found corrupted then follow the steps in "Repairing DCOM" on page 265; if not, skip the next section and go directly to "Setting the Firewall" on page 267.

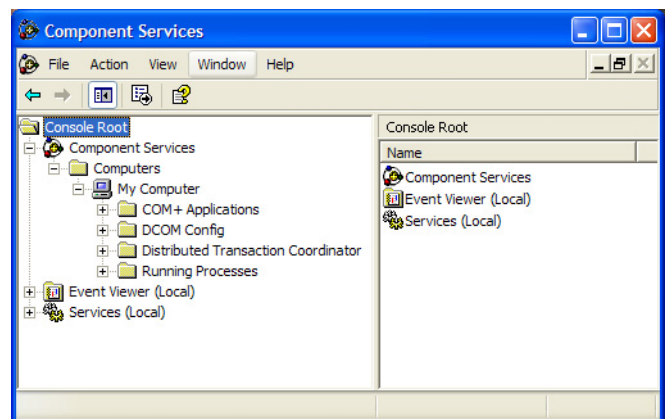

3. Click the **COM+ Applications** branch. The components of this branch will be displayed. If you get an error message and/or cannot access this branch of components, you must repair DCOM. If your DCOM configuration is found corrupted then follow the steps in "Repairing DCOM" on page 265; if not, skip the next section and go directly to "Setting the Firewall" on page 267.

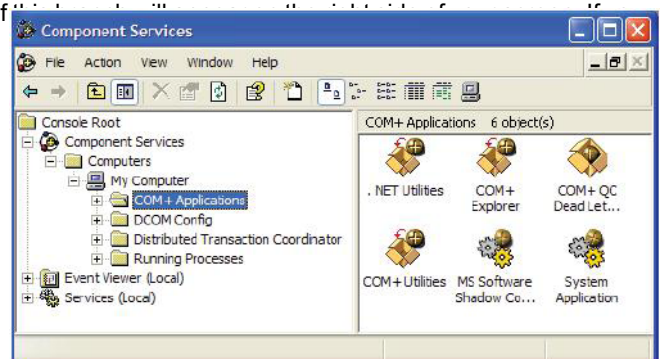

# CENTAUR

## Integrated Access Control V8.0

### Repairing DCOM

Perform the following steps to repair your DCOM configuration:

1. From the taskbar, click **Start -> Run**. The **Run** window will appear. Enter **cmd** in the text box and click **OK**.
2. The **C:\WINDOWS\System32\cmd.exe** window will appear. Type **cd %systemroot%\system32** and press the keyboard **Enter** key. Type **msdtc -uninstall** and press the keyboard **Enter** key.

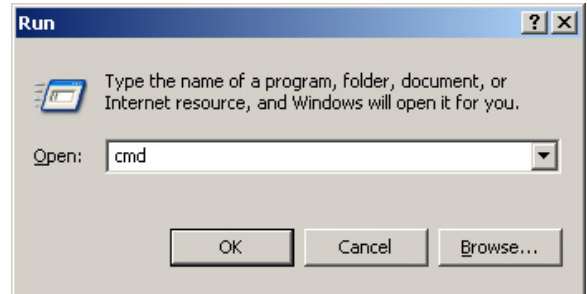

```

C:\ Select C:\WINDOWS\system32\cmd.exe
Microsoft Windows XP [Version 5.1.2600]
(C) Copyright 1985-2001 Microsoft Corp.

C:\Documents and Settings\Technical Support>cd %systemroot%\system32
C:\WINDOWS\system32>msdtc -uninstall
  
```

3. Reboot your computer.
4. From the taskbar, click **Start -> Run**. The **Run** window will appear. Enter **cmd** in the text box and click **OK**.
5. The **C:\WINDOWS\System32\cmd.exe** window will appear. Type **cd %systemroot%\system32** and press the keyboard **Enter** key. Type **msdtc -install** and press the keyboard **Enter** key.

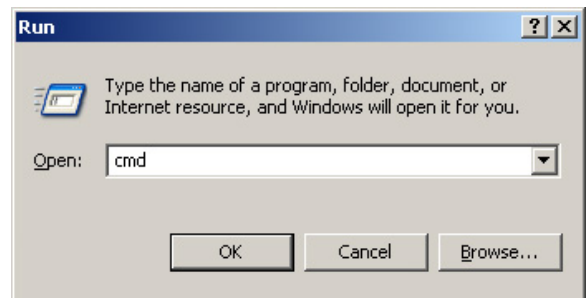

```

C:\ Select C:\WINDOWS\system32\cmd.exe
Microsoft Windows XP [Version 5.1.2600]
(C) Copyright 1985-2001 Microsoft Corp.

C:\Documents and Settings\Technical Support>cd %systemroot%\system32
C:\WINDOWS\system32>msdtc -install_
  
```

# CENTAUR

## Integrated Access Control V8.0

### Verifying if the DCOM has been repaired

Perform the following steps to verify that DCOM has been repaired:

1. From the taskbar, click **Start -> Run**.  
The **Run** window will appear. Enter **dcomcnfg.exe** in the text box and click **OK**.

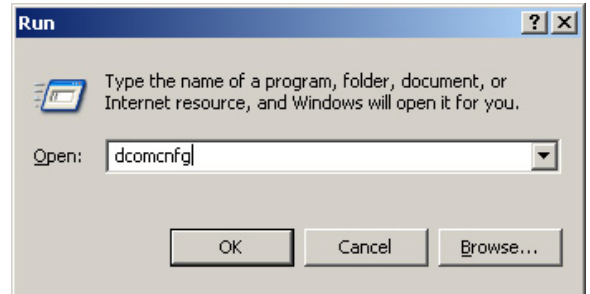

2. The **Component Services** window will appear. In the **Console Root** folder (left side of your screen), expand the **Component Services** branch, the **Computers** branch, and the **My Computer** branch. If there is a red arrow next to any of the components of this folder, DCOM has not been successfully repaired and you must repeat the repairing process.

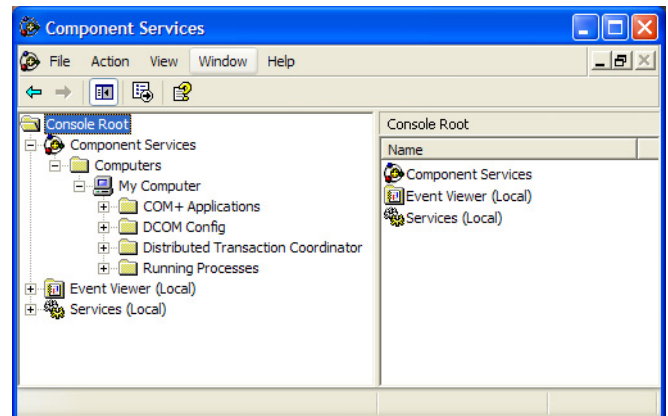

# CENTAUR

## Integrated Access Control V8.0

### Setting the Firewall

Firewall settings need to be altered on the Centaur Server computer and on any workstation connecting to the Centaur Server computer through DCOM.

On the **server** you need to :

- **Open the port 135** (DCOM port)
- Allow access (In bound and Out bound)) for the program SPXSVR.exe found on C:\Program Files\CDV Americas\Centaur\Centaur Server .
- Allow access (In bound and Out bound) for the program **sqlsevr.exe** found on C:\Program Files\Microsoft SQL Server\MSSQL\Binn\.

On the **workstation** you need to :

- **Open the port 135** (DCOM port)



---

*Please make sure that all your network devices allow DCOM (port 135).*

---

Please refer to your firewall documentation if you need help. If you are using the Windows firewall follow these steps to alter your settings:

1. From the taskbar, click **Start -> Control Panel**.
2. The **Control Panel** window will appear. Double-click on the **Windows Firewall** icon.



# CENTAUR

## Integrated Access Control V8.0

3. The **Windows Firewall** window will appear. From the **Exceptions** ta

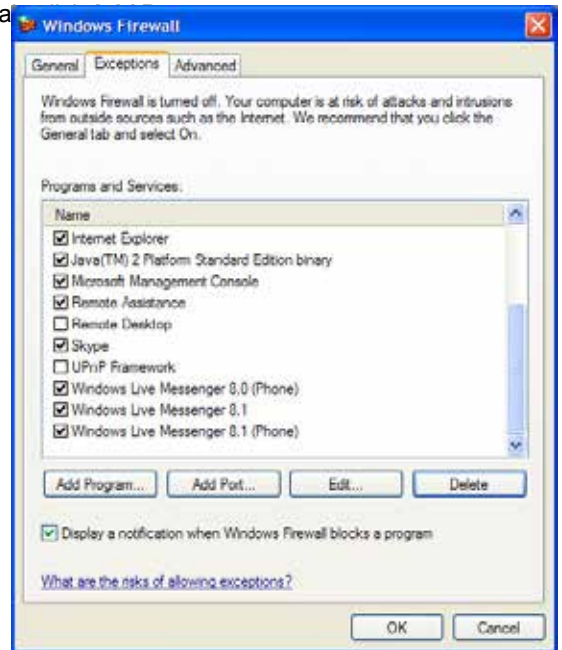

4. The **Add a Port** window will appear. In the **Name** field, enter **DCOM**. In the **Port number** field, enter **135**. Select **TCP** as your communication type and click **OK**.

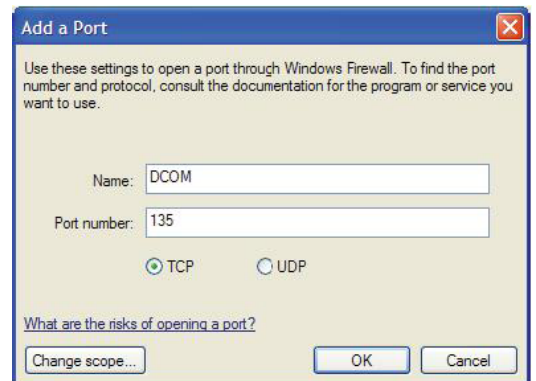

# CENTAUR

## Integrated Access Control V8.0

- The **Windows Firewall** window will re-appear. From the **Exceptions** tab, make sure that the **DCOM** check box below the **Programs and Services** heading is selected.

If you are configuring the firewall settings on a workstation connected to the Centaur Server computer, click **OK** and your done with this computer.

If you are configuring your firewall settings on the Centaur Server computer, go to the next step.

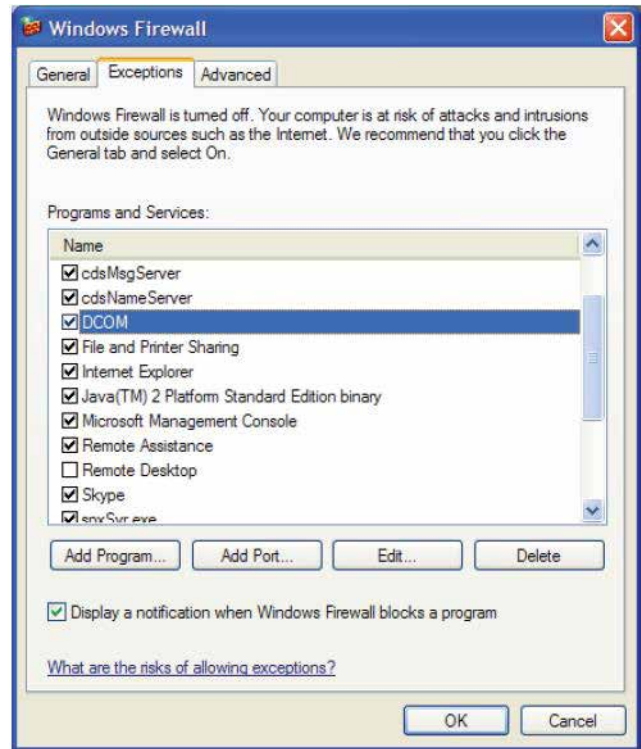

- From the **Exceptions** tab, click **Add Program**.
- The **Add a Program** window will appear. Click **Browse...** and select the **spxsvr.exe** file (located by default in C:\Program Files\CDV Americas\Centaur\Centaur Server) and click **OK**.
- The **Windows Firewall** window will re-appear. From the **Exceptions** tab, make sure that the **spxsvr.exe** check box below the **Programs and Services** heading is selected.
- From the **Exceptions** tab, click **Add Program**.

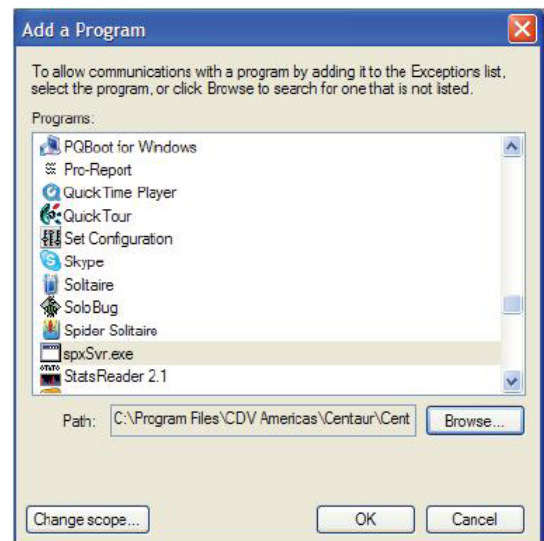

# CENTAUR

## Integrated Access Control V8.0

- The **Add a Program** window will appear. Click **Browse...** and select the **sqlsevr.exe** file (located by default in C:\Program Files\Microsoft SQL Server\MSSQL\Binn\ ) and click **OK**.

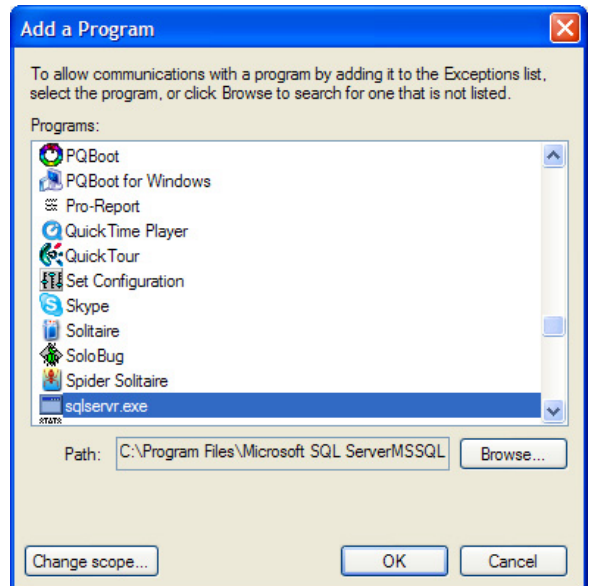

- The **Windows Firewall** window will re-appear. From the **Exceptions** tab, make sure that the **sqlsevr.exe** check box below the **Programs and Services** heading is selected.

- Click **OK**.

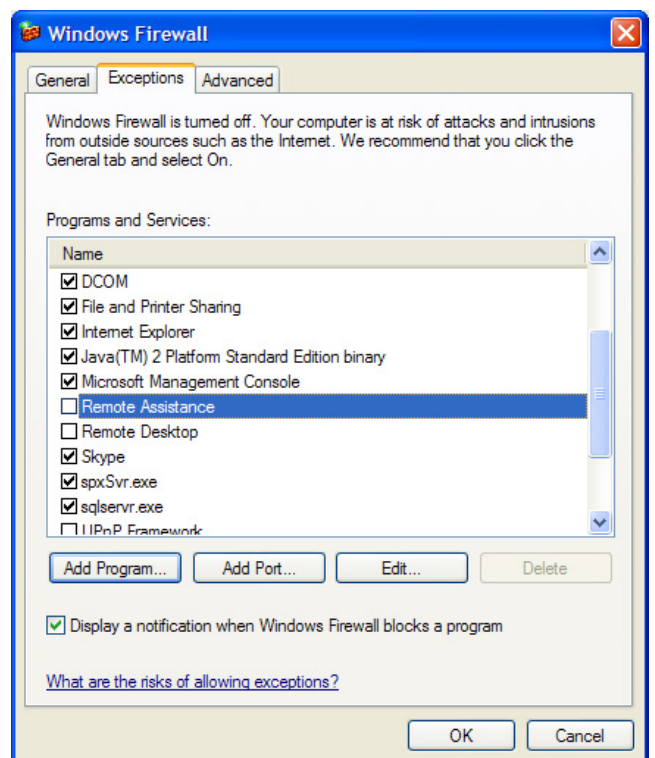

# CENTAUR

## Integrated Access Control V8.0

### ENABLING NETWORK ACCESS ON WINDOWS XP

In order to be able to setup the DCOM on computers running on Windows XP, the network access must be enabled.

1. From the taskbar, click **Start -> Settings -> Control Panel**.
2. Double-click **Administrative Tools**.



# CENTAUR

## Integrated Access Control V8.0

3. Double-click **Local Security Policy**.

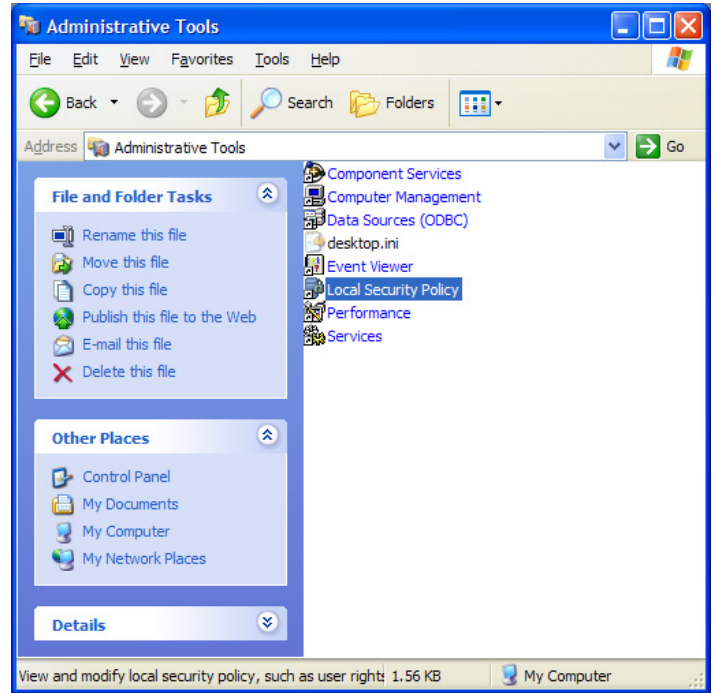

# CENTAUR

## Integrated Access Control V8.0

- Expand the **Local Policies** branch, and click **Security Options**.

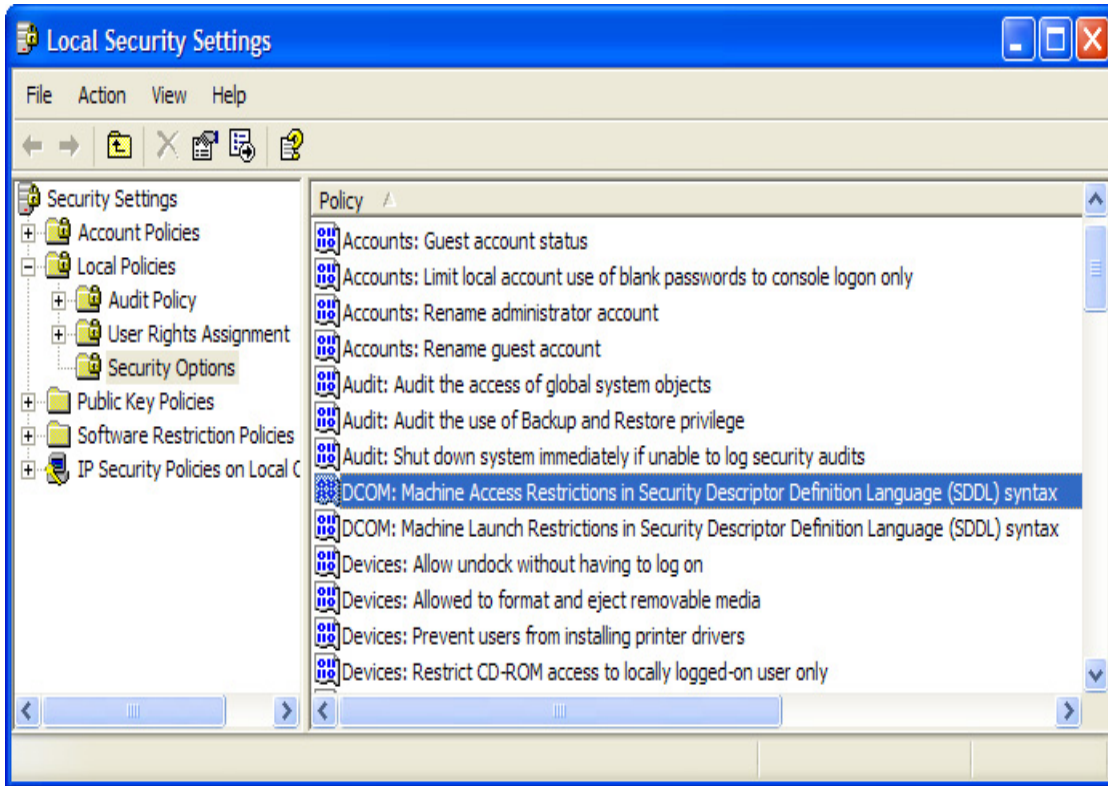

- Double-click **Network Access: Sharing and security model for local account**.

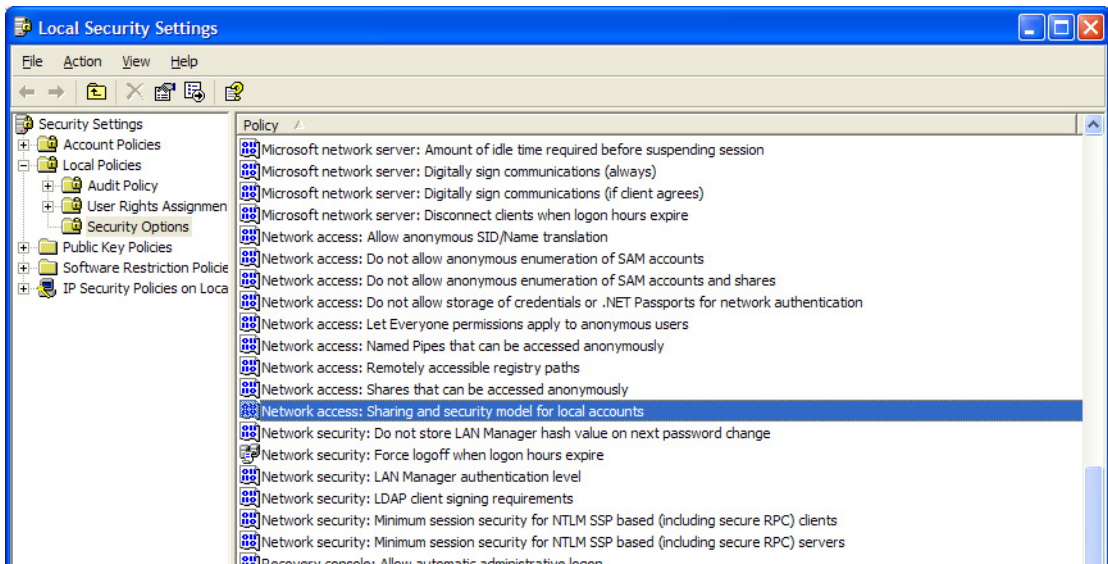

# CENTAUR

## Integrated Access Control V8.0

6. The **Network Access: Sharing and security model for local account** window will appear. From the drop-down list, click on **Classic - local users authenticate as themselves** and click **OK**.

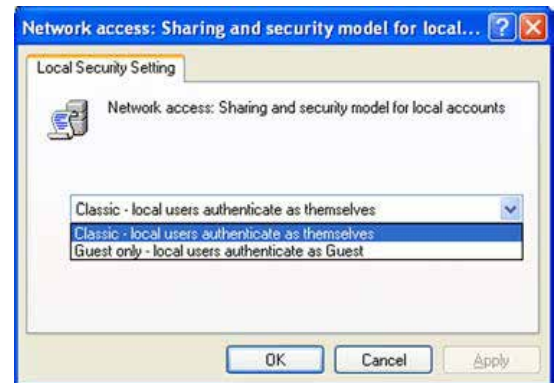

# CENTAUR

## Integrated Access Control V8.0

### Configuring the DCOM on Windows XP

1. In **Control Panel** open the **Administrative Tools** -> **Computer Management**.

2. Open **Local Users and Groups**.

3. If the computers belong to a workgroup, you have to create the users locally before starting; if the computers belong to a domain, go to step 4.

- a) Create the users locally on the server. For this, right-click on **Users** and choose **New User**. In this new window, type the information about that user and click **OK**. Pay special attention to the user name and password that you are using to open the Windows session.

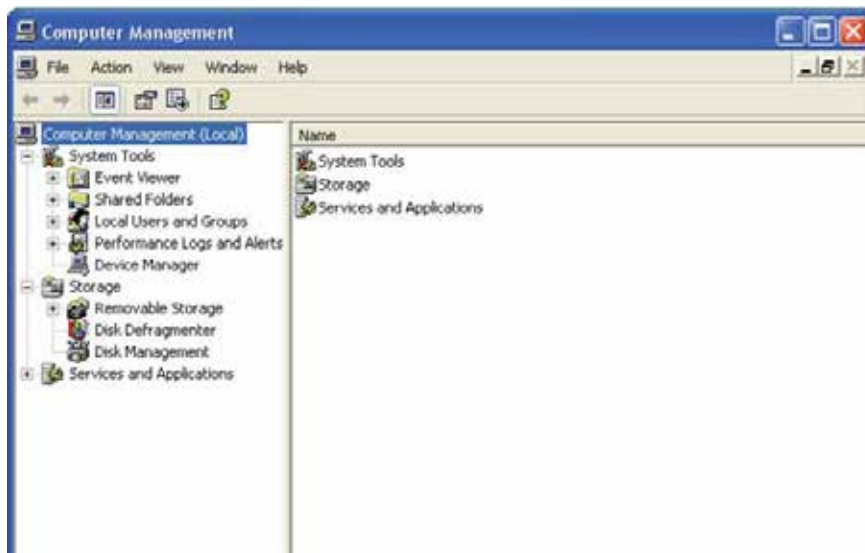

- b) Repeat the previous step for all the users you want to add, then go to the next step.

# CENTAUR

## Integrated Access Control V8.0

4. To create the group to be used for DCOM you have to click on the **Groups** and select **New Group**.
5. In the field **Name** type **Centaur Group**. Click on the **Add...** button to add the users that you want to have access to the Centaur Server.
6. The window **Select Users, Computers or Groups** pops-up. Click on the **Advanced ...** button and check if the **Object Types ...** and **Locations ...** are properly set and click on the **Find Now** button. Select from the list the users you want to access the Server. For a multiple selection, keep pressed the keyboard **Ctrl** key while selecting the names from the list. Click **OK**.
7. The selected users will appear in the **Select Users, Computers or Groups**, and the **Enter the object names to select (examples)** field. Click **OK**.
8. Click **Close**.
9. From the taskbar, click **Start -> Run**.

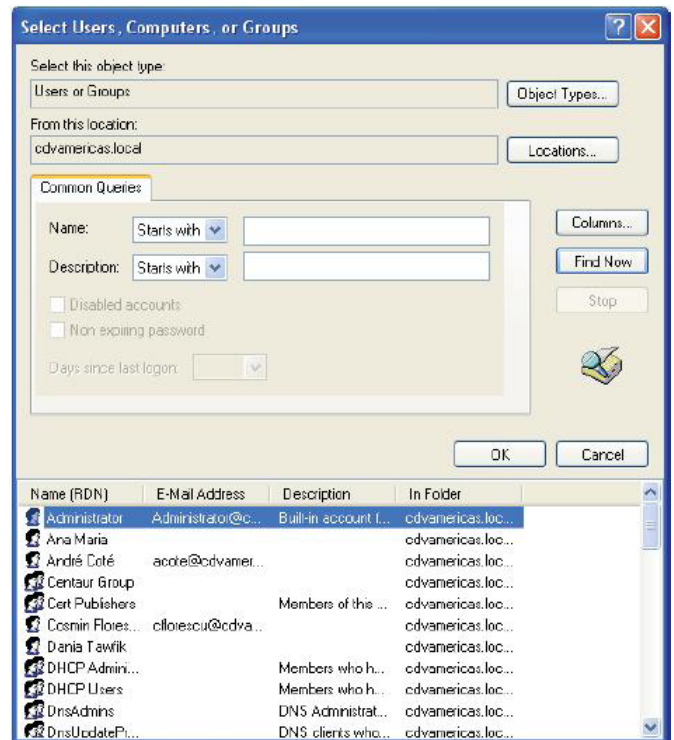

10. In the **Run** window type **dcomcnfg.exe**. Click **OK** or press the keyboard **Enter** key.

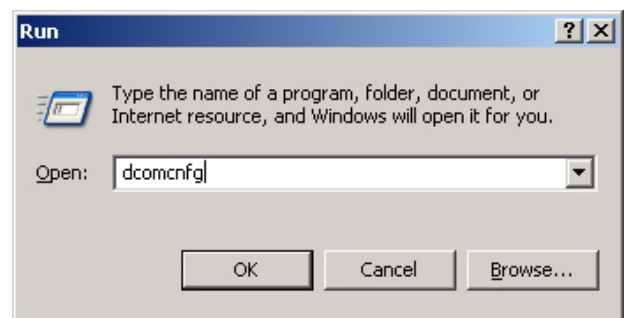

# CENTAUR

## Integrated Access Control V8.0

- 11. The **Component Services** window will appear. Expand the **Component Services**, **Computers**, and **MyComputer** branches, and click **DCOM Config**.

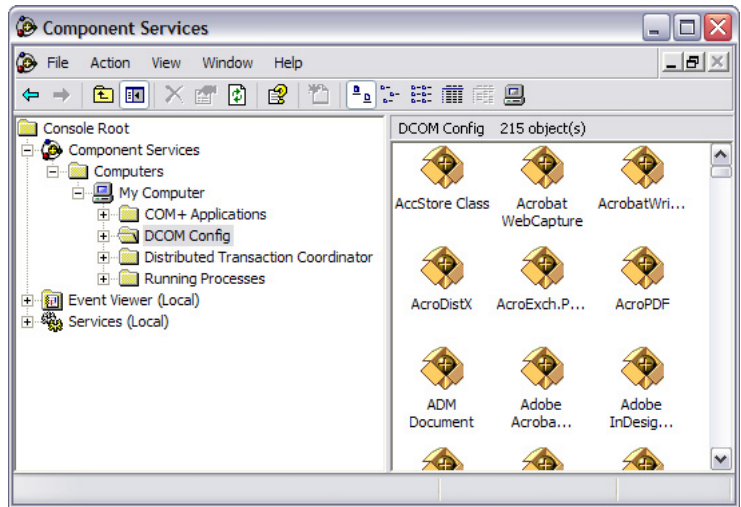

- 12. Right-click the **SpxSvr** file and click **Properties**.

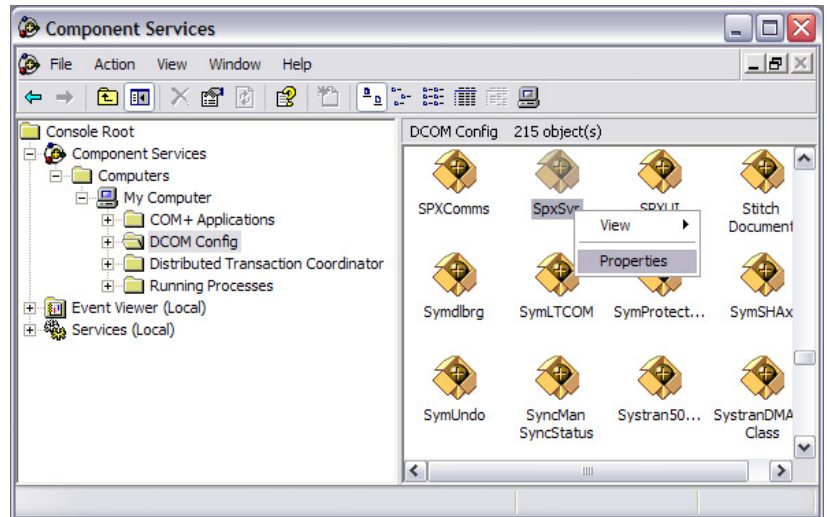

# CENTAUR

## Integrated Access Control V8.0

13. The **SpxSvr Properties** window will appear. From the **Authentication**
14. Click the **Location** tab and select the **Run application on this computer** check box.  
NB: The **Run application on this computer** check box is selected by default.

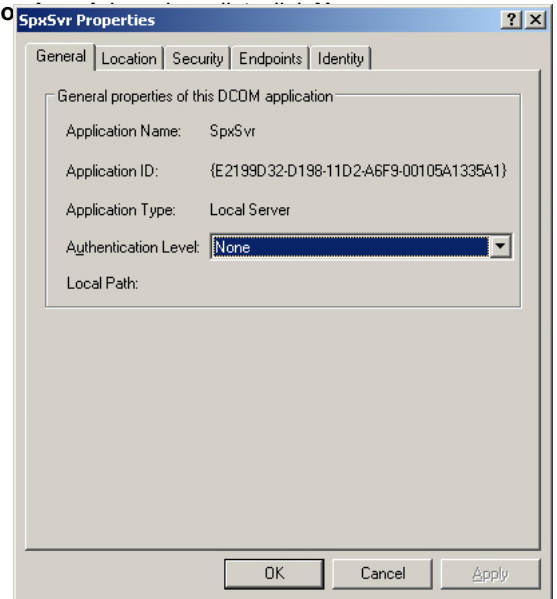

15. Click the **Identity** tab and select the **The interactive user** check box.

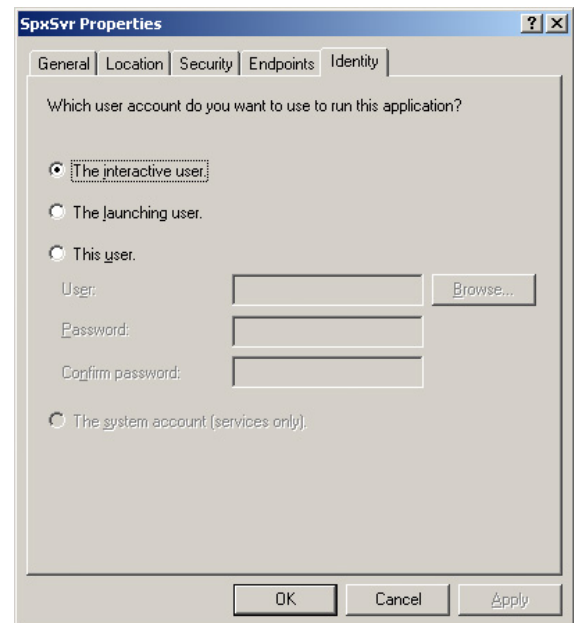

# CENTAUR

## Integrated Access Control V8.0

16. Click the **Security** tab to configure the user(s) that have(s) the right
  - a) Under **Launch Permissions**, click **Customize**.
  - b) Under **Access Permissions**, click **Customize**.
  - c) Under **Configuration Permissions**, click **Use Default**.
17. Under **Launch Permissions**, click the **Edit** button.

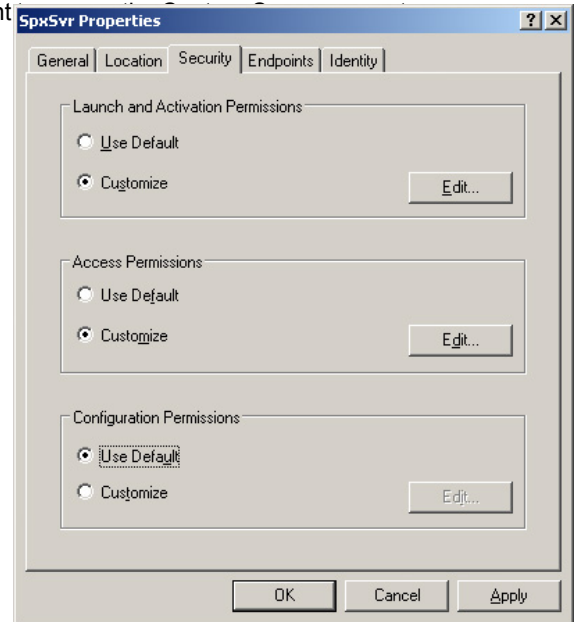

18. The **Launch Permission** window will appear. Click the **Add** button to add users..
19. The **Select Users or Groups** window will appear. Verify that the **Object Type** and the **Location** is correct and click **Find Now**. Select the desired user from the list. Hold down the keyboard **Ctrl** key to select multiple users. Click **OK**.

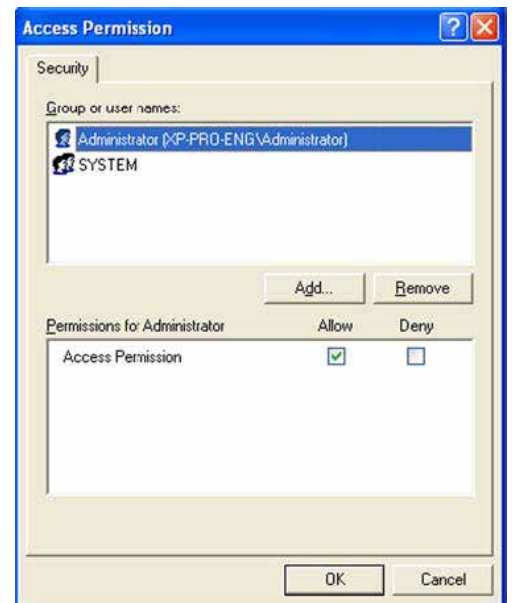

# CENTAUR

## Integrated Access Control V8.0

- 20. The Centaur Group appears now in the **Select Users or Groups** window. Click **OK**.
- 21. Click **OK**.
- 22. From the taskbar, click **Start -> Control Panel -> Administrative Tools -> Local Security Policy**.

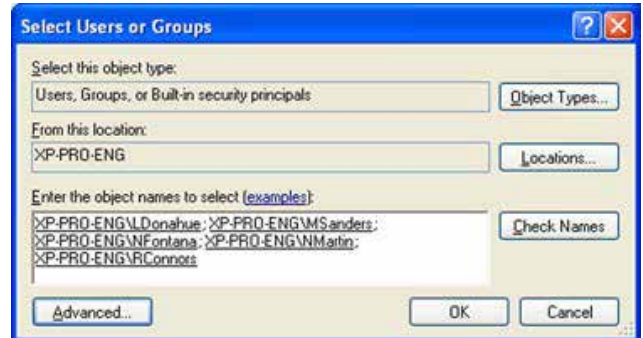

- 23. The **Local Security Settings** window will appear. Double-click **DCOM: Machine Access Restrictions in Security Descriptor Definition Language (SDDL) syntax**.

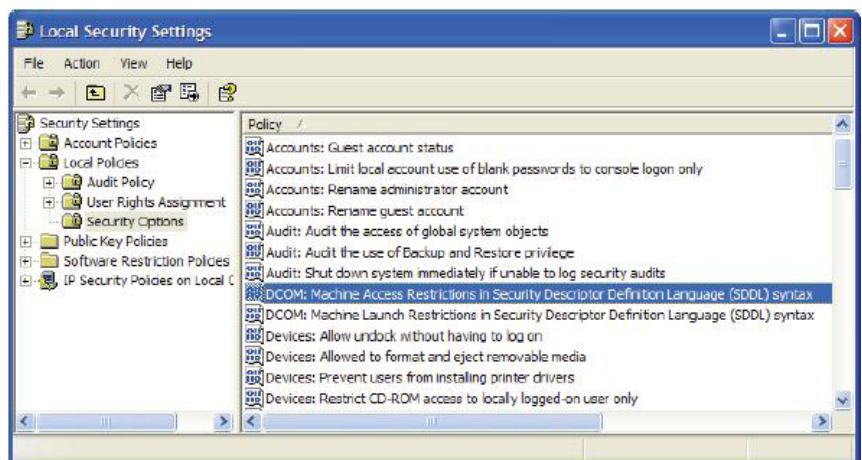

- 24. The **DCOM: Machine Access Restrictions in Security Descriptor** window will appear. Click **Edit Security**.



# CENTAUR

## Integrated Access Control V8.0

25. The **Access Permission** window will appear.  
Beneath the **Group or user names** heading, select the desired users who will be granted access to the Centaur Server computer through DCOM and click **Add**.
26. Beneath the **Centaur Group** heading, ensure all **Allow** check boxes are selected.
27. Click **OK**.

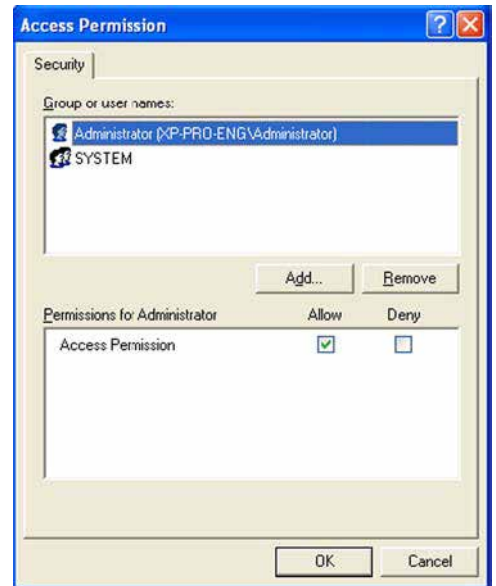

# CENTAUR

## Integrated Access Control V8.0

### DCOM CONFIGURATION FOR WINDOWS 2003 SERVER

To be able to configure the DCOM on Windows 2003 operating system, you have to be logged in as **Administrator**.

#### Verifying DCOM

Before going on with the DCOM configuration, you can perform the following steps to verify the integrity of your DCOM:

1. From the taskbar, click **Start -> Run**. The Run window will appear. Enter **dcomcnfg.exe** in the text box and click **OK**.

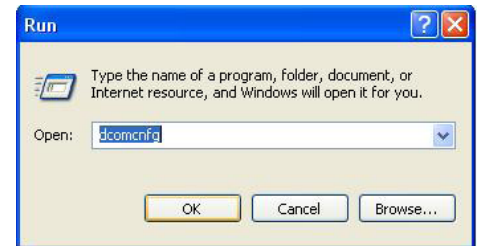

2. The **Component Services** window will appear. Within the **Console Root** folder (left side of your screen), expand the **Component Services** branch, the **Computers** branch, and the **My Computer** branch. Ensure that the **Running Processes** folder appears in the **My Computer** branch. If it does not appear, you must repair DCOM. If your DCOM configuration is found corrupted then follow the steps in "Repairing DCOM" on page 283; if not, go directly to "Setting the Firewall" on page 285.

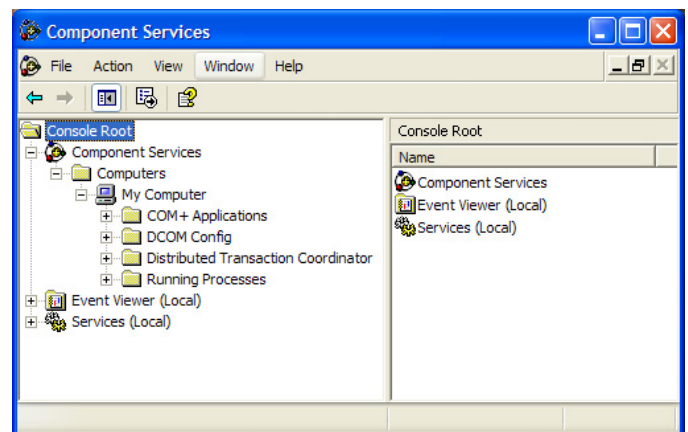

3. Click the **COM+ Applications** branch. The components of this branch will appear on the right of your screen. If you get an error message and/or cannot access this branch of components, you must repair DCOM. If your DCOM configuration is found corrupted then follow the steps in "Repairing DCOM" on page 283; if not, go directly to "Setting the Firewall" on page 285.

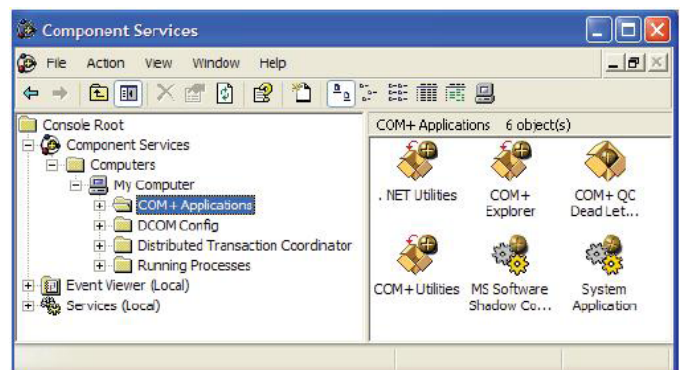

# CENTAUR

## Integrated Access Control V8.0

### Repairing DCOM

Perform the following steps to repair your DCOM configuration:

1. From the taskbar, click **Start -> Run**. The **Run** window will appear. Enter **cmd** in the text box and click **OK**.

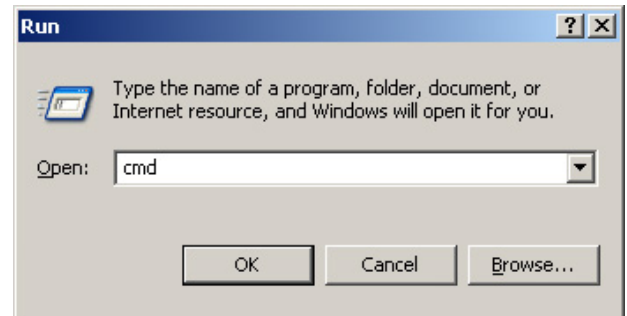

2. The **C:\WINDOWS\System32\cmd.exe** window will appear. Type **cd %systemroot%\system32** and press the keyboard **Enter** key. Type **msdtc -uninstall** and press the keyboard **Enter** key.

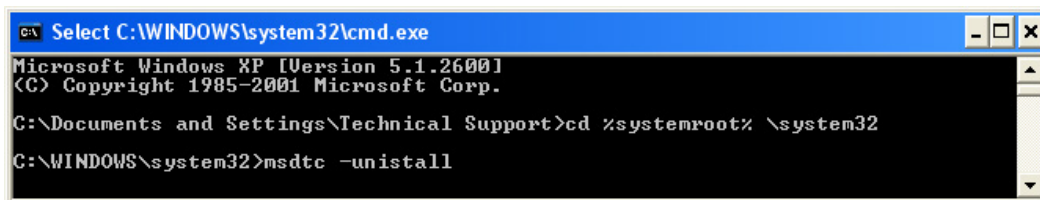

3. Reboot your computer.
4. From the taskbar, click **Start -> Run**. The **Run** window will appear. Enter **cmd** in the text box and click **OK**.

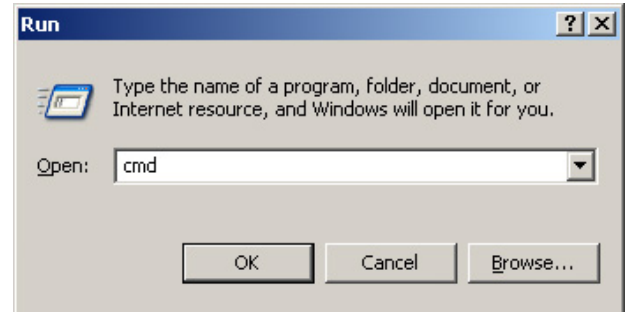

5. The **C:\WINDOWS\System32\cmd.exe** window will appear. Type **cd %systemroot%\system32** and press the keyboard **Enter** key. Type **msdtc -install** and press the keyboard **Enter** key.

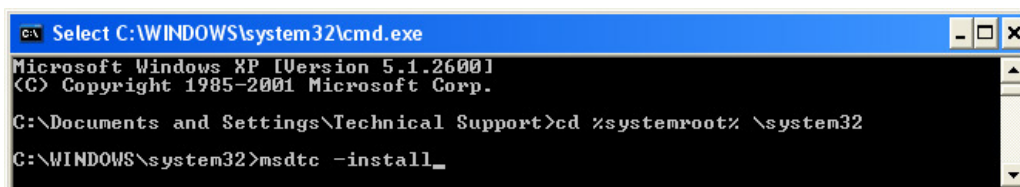

# CENTAUR

## Integrated Access Control V8.0

### Verifying if the DCOM has been repaired

Perform the following steps to verify that DCOM has been repaired:

1. From the taskbar, click **Start -> Run**. The **Run** window will appear. Enter **dcomcnfg.exe** in the text box and click **OK**.

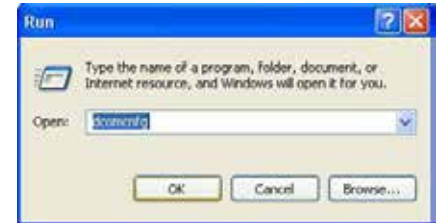

2. The **Component Services** window will appear. In the **Console Root** folder (left side of your screen), expand the **Component Services** branch, the **Computers** branch, and the **My Computer** branch. If there is a red arrow next to any of the components of this folder, DCOM has not been successfully repaired and you must repeat the repairing process.

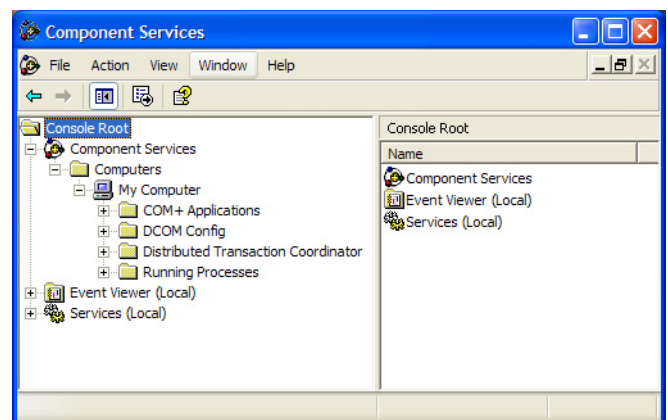

# CENTAUR

## Integrated Access Control V8.0

### Setting the Firewall

Firewall settings need to be altered on the Centaur Server computer and on any workstation connecting to the Centaur Server computer through DCOM.

In your firewall you have to:

**Open the port 135** (DCOM port)

Allow access (in entry and exit) for the program SPXSVR.exe found on: C:\Program Files\CDV Americas\Centaur\Centaur Server on **BOTH** workstation and server.

On the **server only** you need to allow access (in entry and exit) for the program **sqlsevr.exe** found on C:\Program Files\Microsoft SQL Server\MSSQL\Binn\.

Please refer to your firewall documentation if you need help. If you are using the Windows firewall follow these steps to alter your settings:

1. From the taskbar, click **Start -> Control Panel**.
2. The **Control Panel** window will appear. Double-click on the **Windows Firewall** icon.



# CENTAUR

## Integrated Access Control V8.0

3. The **Windows Firewall** window will appear. From the **Exceptions** tab, click **Add Port**.

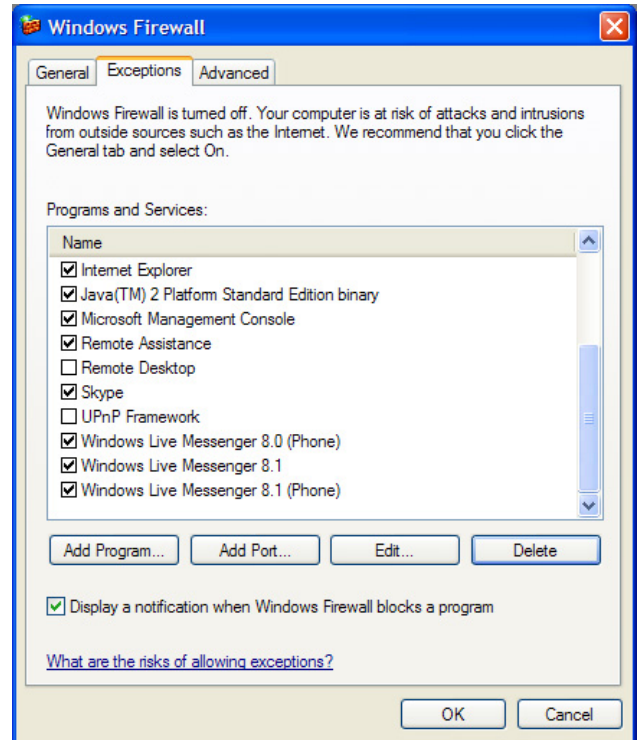

4. The **Add a Port** window will appear. In the **Name** field, enter **DCOM**. In the **Port number** field, enter **135**. Select **TCP** as your communication type and click **OK**.

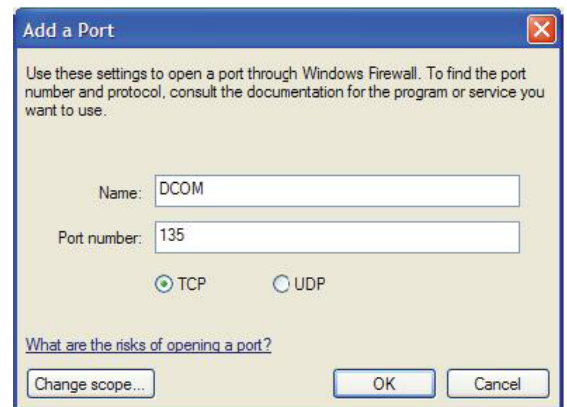

# CENTAUR

## Integrated Access Control V8.0

- The **Windows Firewall** window will re-appear. From the **Exceptions** tab, make sure that the **DCOM** check box below the **Programs and Services** heading is selected.

If you are configuring/repairing the firewall settings on a **workstation** connected to the Centaur Server computer, click **OK** and your done with this computer.

If you are repairing your firewall settings on the **Centaur Server** computer, go to the next step.

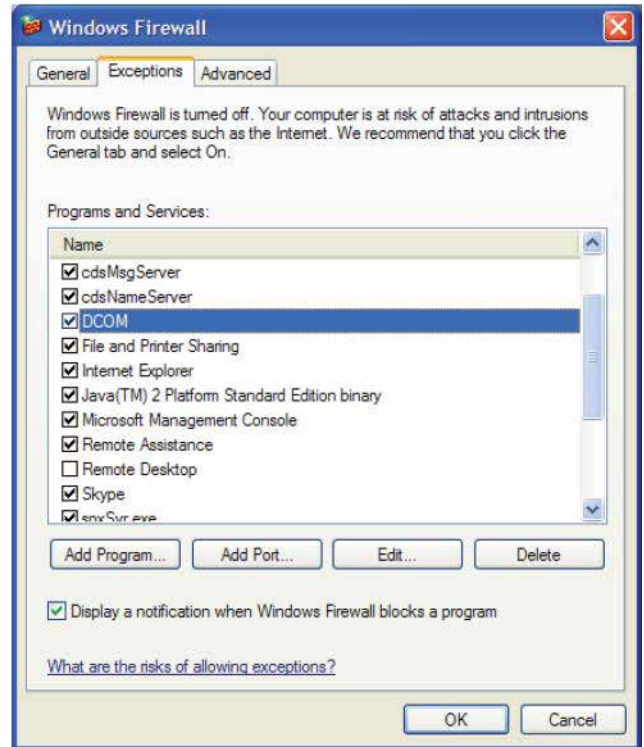

- From the **Exceptions** tab, click **Add Program**.
- The **Add a Program** window will appear. Click **Browse...** and select the **spxsvr.exe** file (located by default in C:\Program Files\CDV Americas\Centaur\Centaur Server) and click **OK**.
- The **Windows Firewall** window will re-appear. From the **Exceptions** tab, make sure that the **spxsvr.exe** check box below the **Programs and Services** heading is selected.
- From the **Exceptions** tab, click **Add Program**.

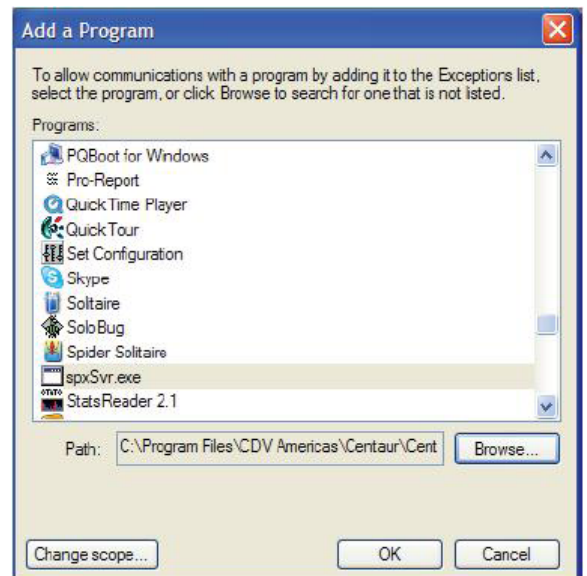

# CENTAUR

## Integrated Access Control V8.0

10. The **Add a Program** window will appear. Click **Browse...** and select the **sqlsevr.exe** file (located by default in C:\Program Files\Microsoft SQL Server\MSSQL\Binn\ ) and click **OK**.
11. The **Windows Firewall** window will re-appear. From the **Exceptions** tab, make sure that the **sqlsevr.exe** check box below the **Programs and Services** heading is selected.
12. Click **OK**.

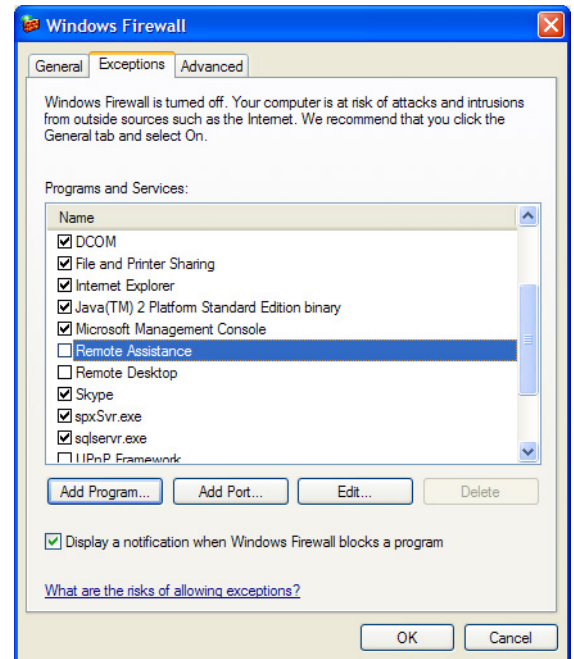

# CENTAUR

## Integrated Access Control V8.0

### DCOM Configuration

1. Go to **Start -> Settings -> Control Panel** and double-click on **Administrative Tools**.

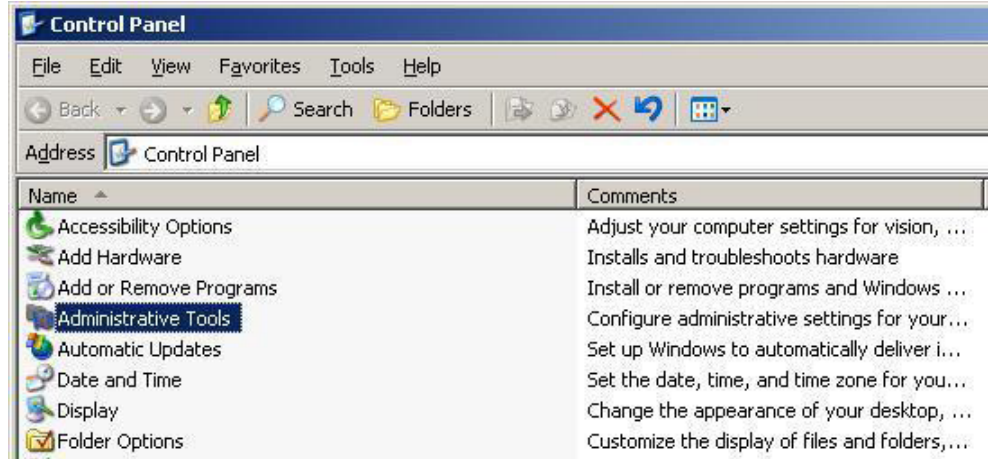

2. From here, double-click on **Active Directory Users and Computers**.

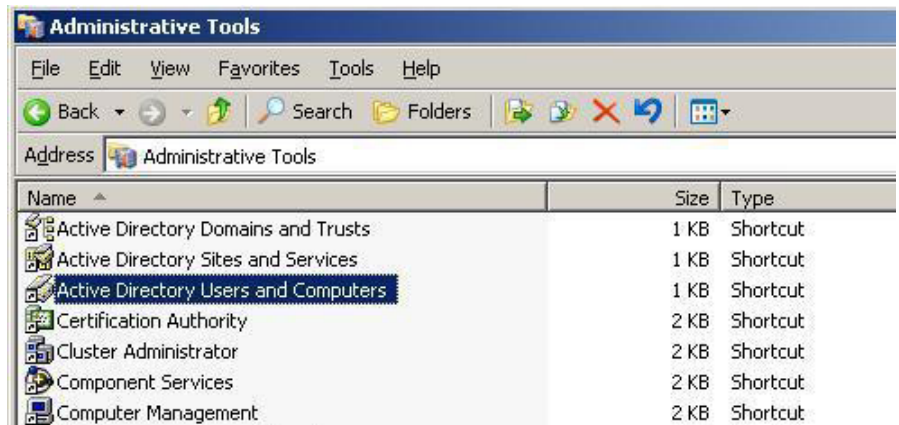

# CENTAUR

## Integrated Access Control V8.0

- Here, right-click on **Users**, point to **New** and choose **Group**.

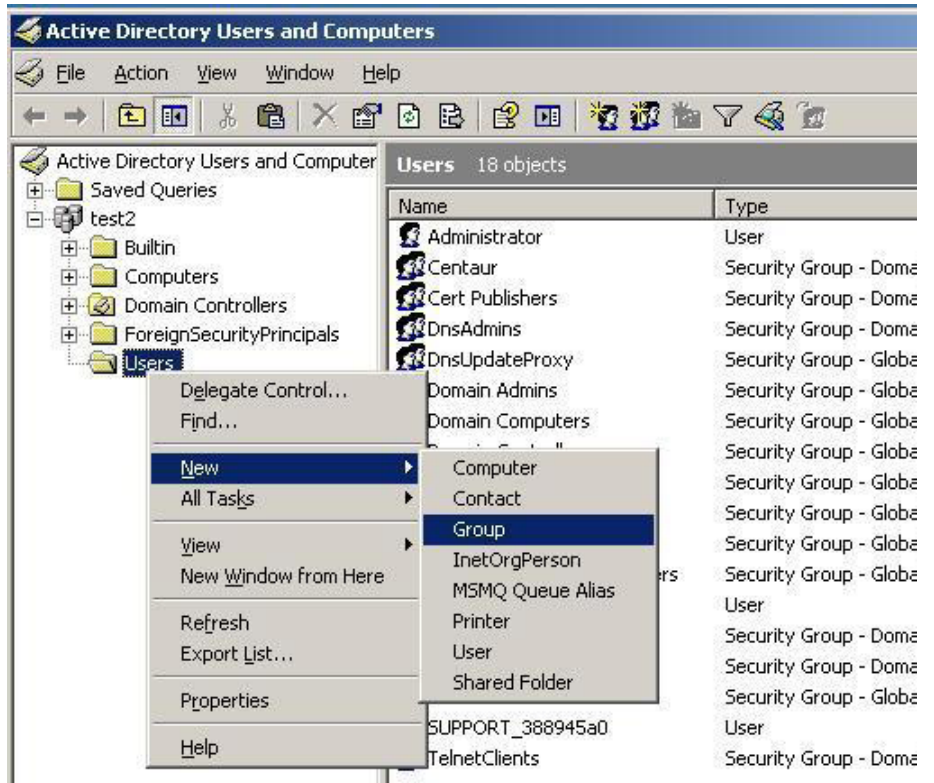

- In the **New Object – Group** window type a name in the **Name** field and click **OK**.

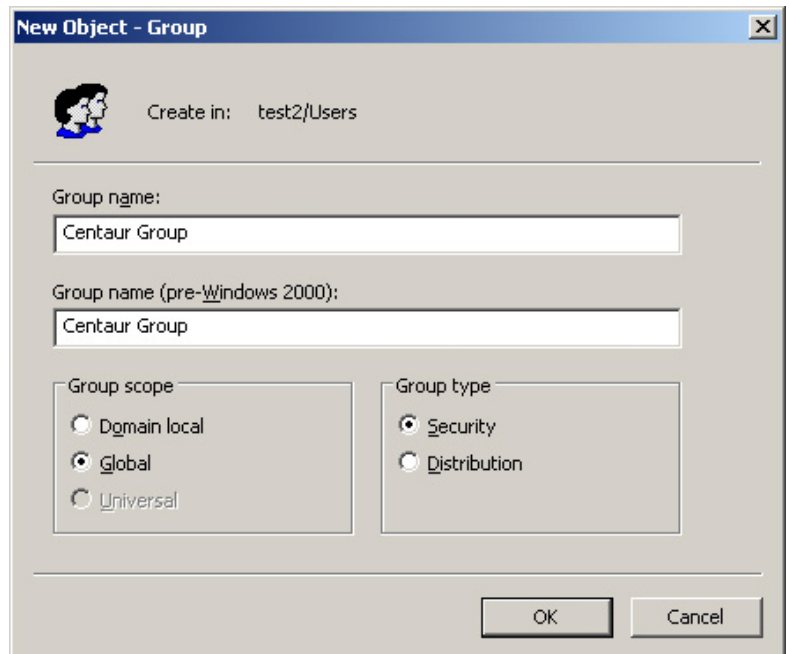

# CENTAUR

## Integrated Access Control V8.0

- 5. In the **Active Directory – Users and Computers** window double-click on **Users**. In the right panel, right-click on the new created group and choose **Properties**.

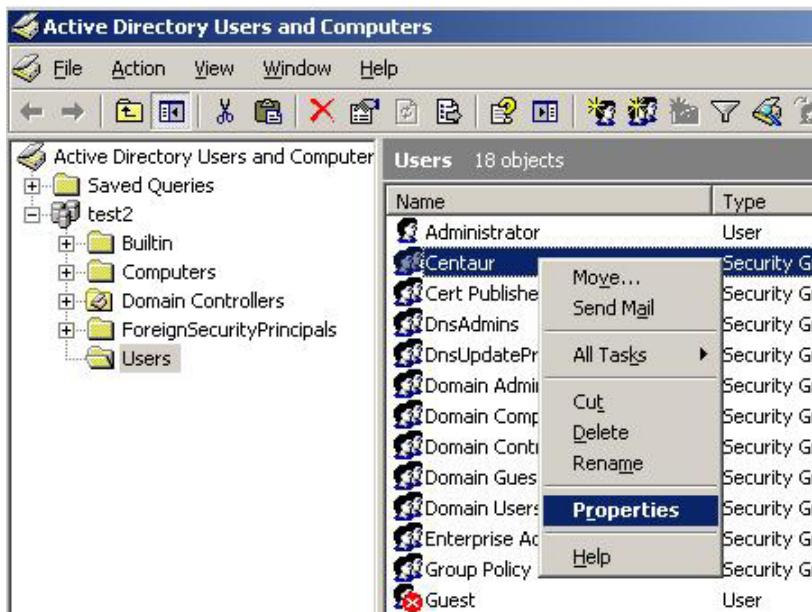

- 6. In the **Members** tab, click on the **Add** button.

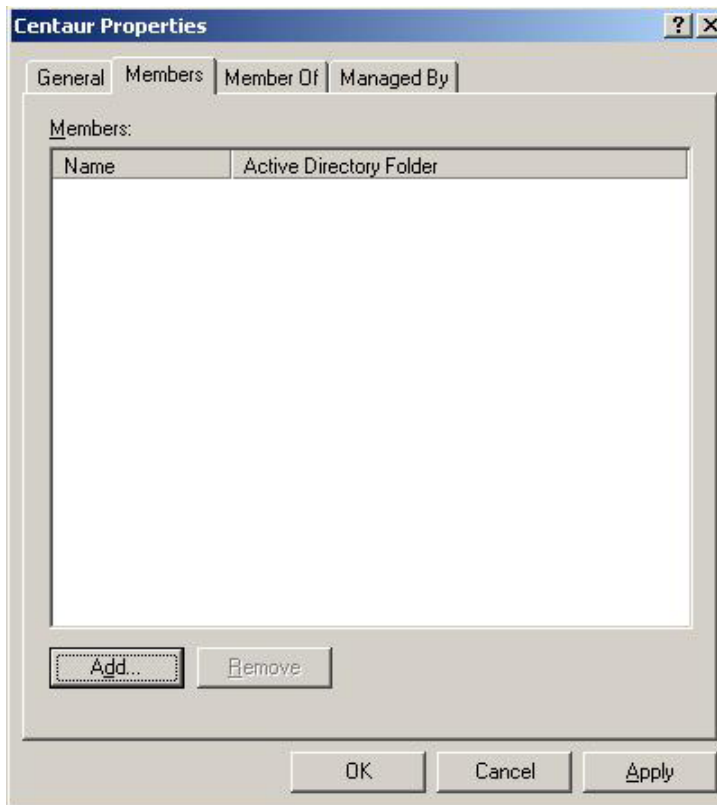

# CENTAUR

## Integrated Access Control V8.0

- In the **Select Users, Contacts, Computers or Groups** window type the domain's user name in the **Enter the Object Names to Select**.

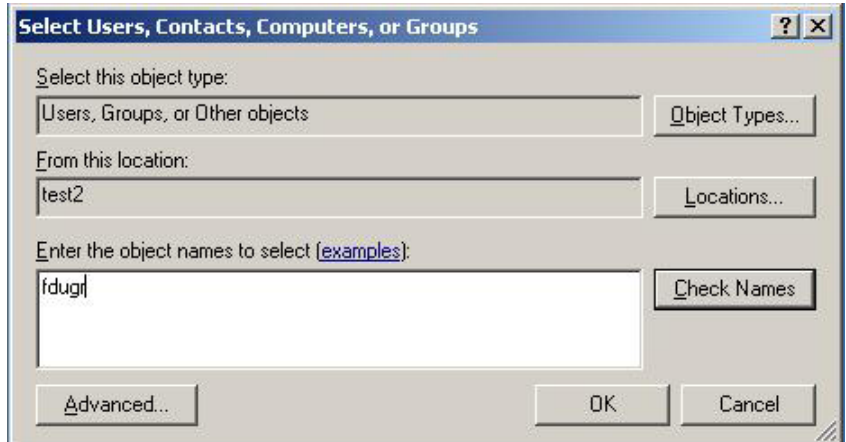

- Click on the **Check Names** button to validate the user's name and click **OK** to add the user into the group.
- Redo the step 6 for all the authorized users.



# CENTAUR

## Integrated Access Control V8.0

- In the new group's properties, the **Member of** tab, click on the **Add** button.

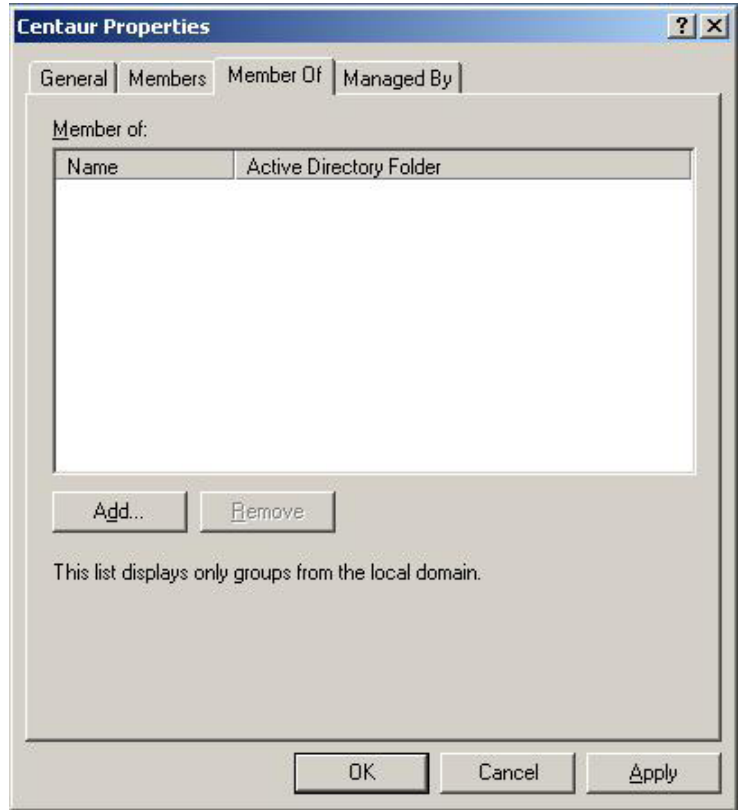

- In the **Select Groups** window, type the model's users in the **Enter the Object Names to Select**.

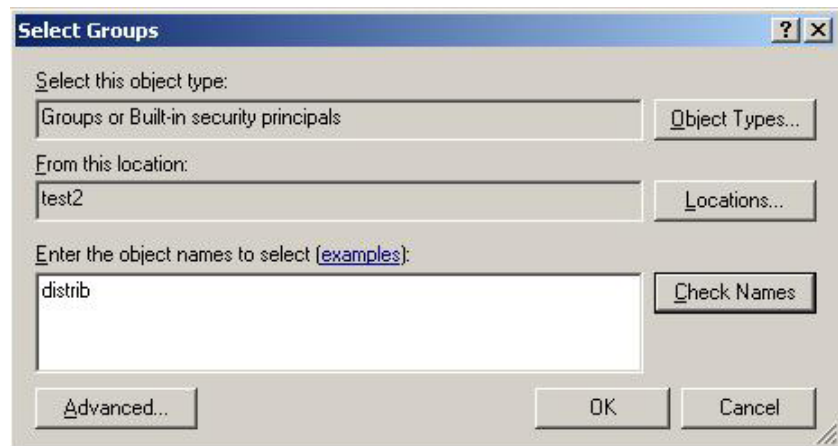

# CENTAUR

## Integrated Access Control V8.0

- Click on the **Check Names** button to validate the group's name and click **OK**.

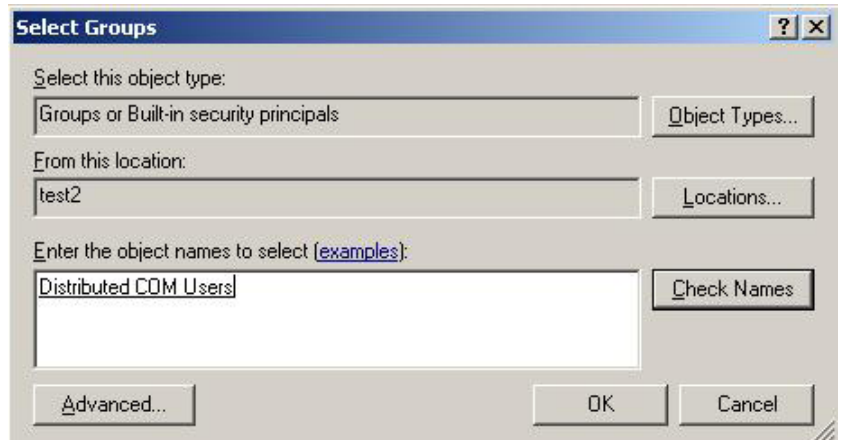

- Click on **Start** in Windows, type **dcomcnfg** and click **OK**.

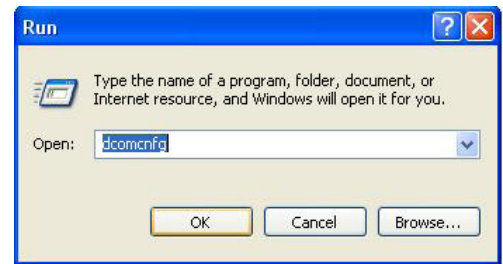

- From **Console Root** expand the **Component Services**, **Computers**, and **My Computer**.



# CENTAUR

## Integrated Access Control V8.0

15. In the **Default Protocols** tab, check if the **Connection-oriented TCP/IP** exists in the **DCOM Protocols** window; if not, add it clicking the **Add** button.

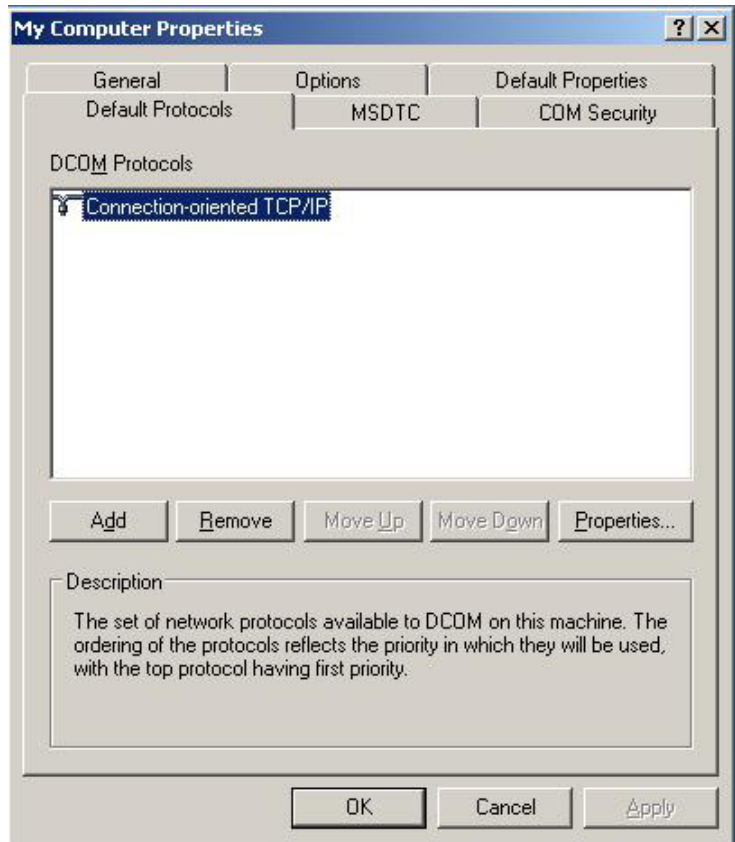

# CENTAUR

## Integrated Access Control V8.0

16. In the **MSDTC** tab, check if the **Service Control Status for MSDTC** is running.

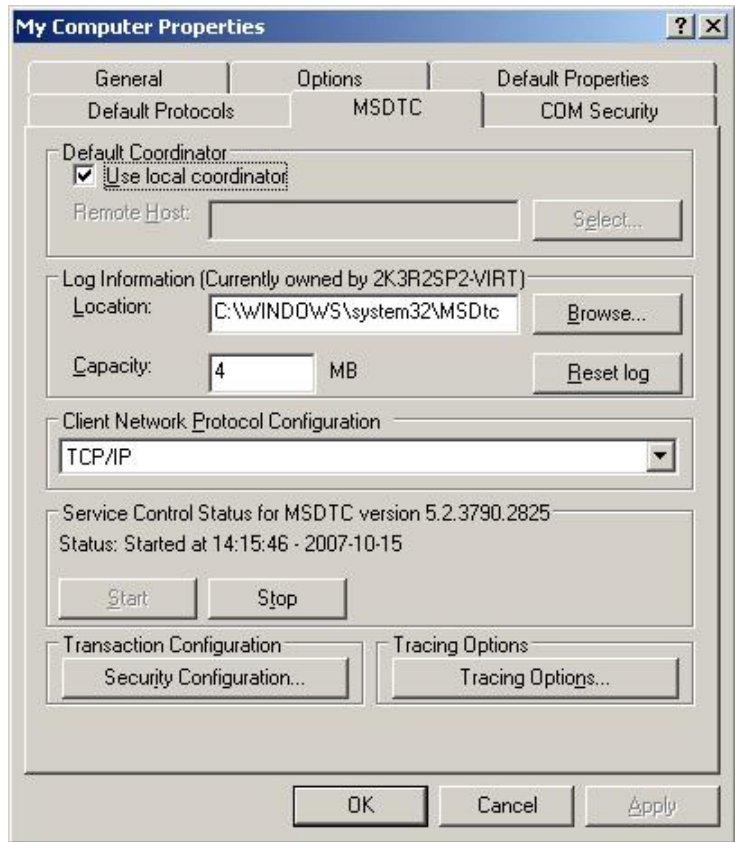

**CENTAUR**  
Integrated Access Control V8.0

17. In the **Default Properties** tab, check if the **Enable Distributed COM on this computer** check box is selected.

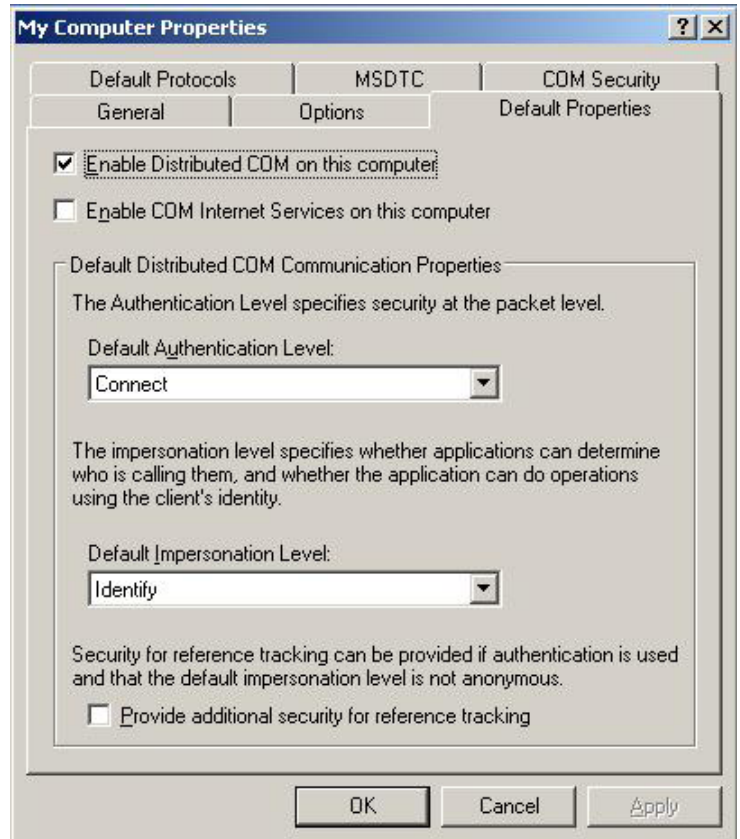

18. Click on **Start** in Windows, type **dcomcnfg**, and click **OK**.

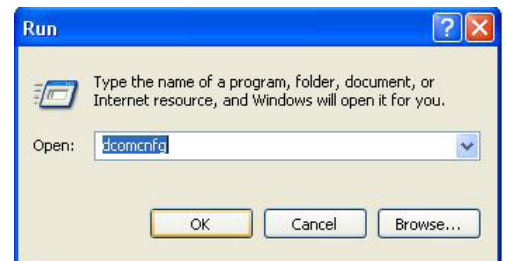

# CENTAUR

## Integrated Access Control V8.0

- The **Component Services** window, expand the **DCOM Config** branches, and click **DCOM Config**.

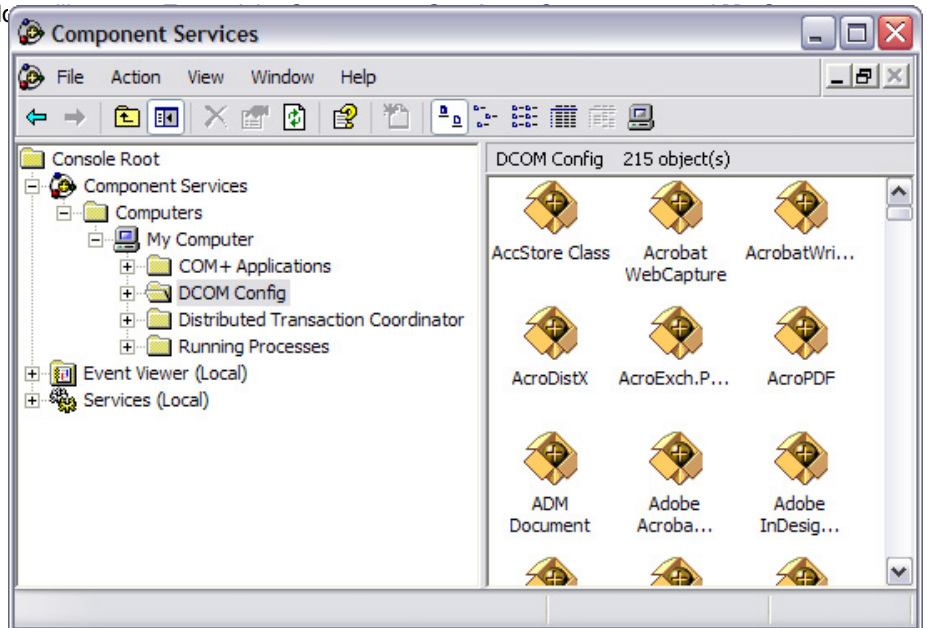

- Right-click the **SpvSvr** file and click **Properties**.

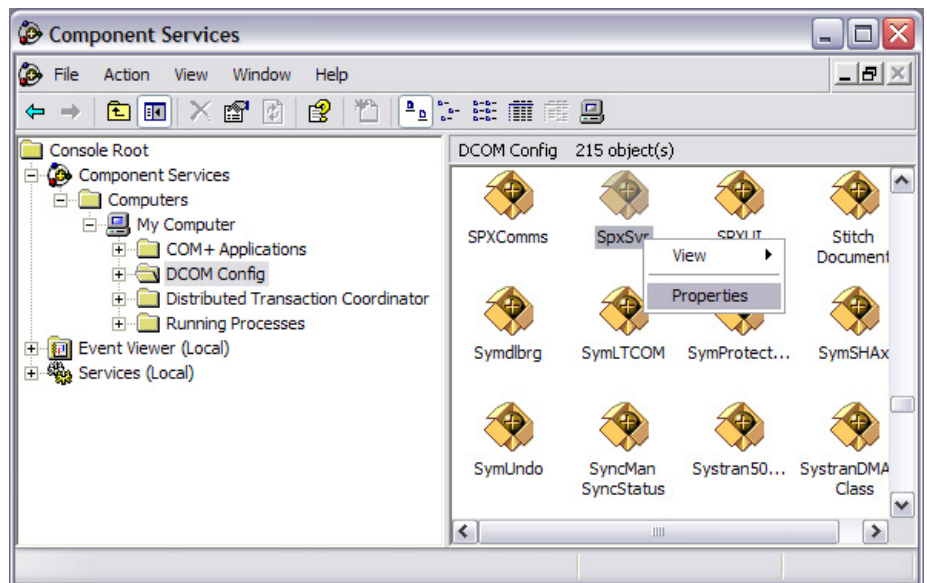

# CENTAUR

## Integrated Access Control V8.0

21. The **SpxSvr Properties** window will appear. From the **Authentication Level** drop-down list, in the **General** tab click **None**.

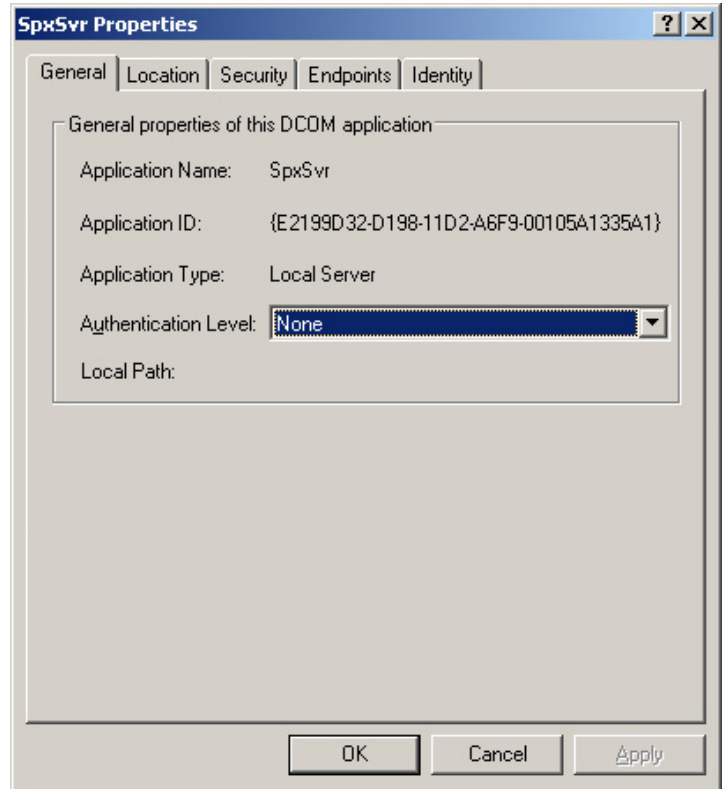

# CENTAUR

## Integrated Access Control V8.0

22. Click the **Security** tab to configure the user

- Under **Launch Permissions**, click **Customize**.
- Under **Access Permissions**, click **Customize**.
- Under **Configuration Permissions**, click **Use Default**.

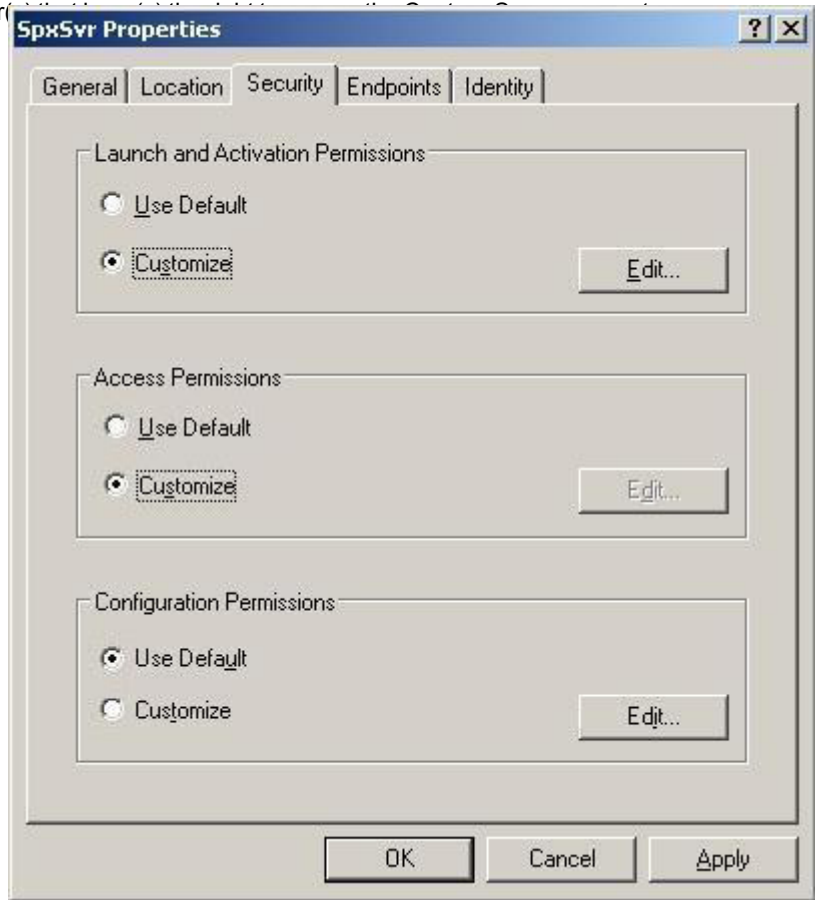

23. In the **Select Users, Contacts, Computers or Groups** window type the group's name you have created in the **Enter the Object Names to Select**.

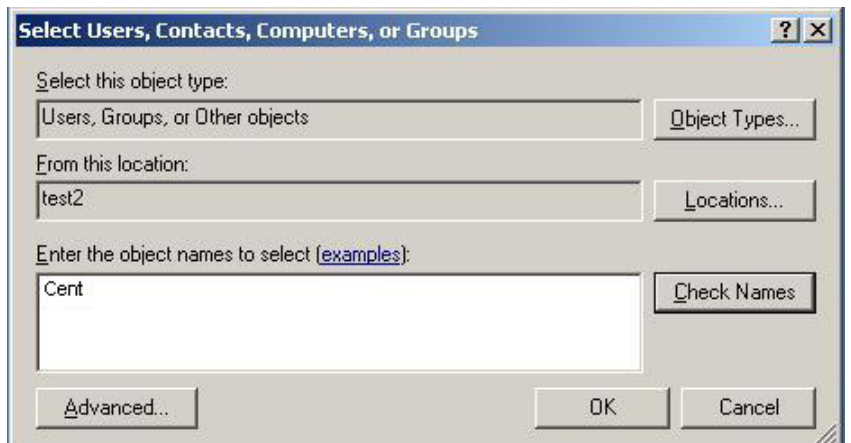

# CENTAUR

## Integrated Access Control V8.0

- Click on the **Check Names** button to validate the name of the group and click **OK**.

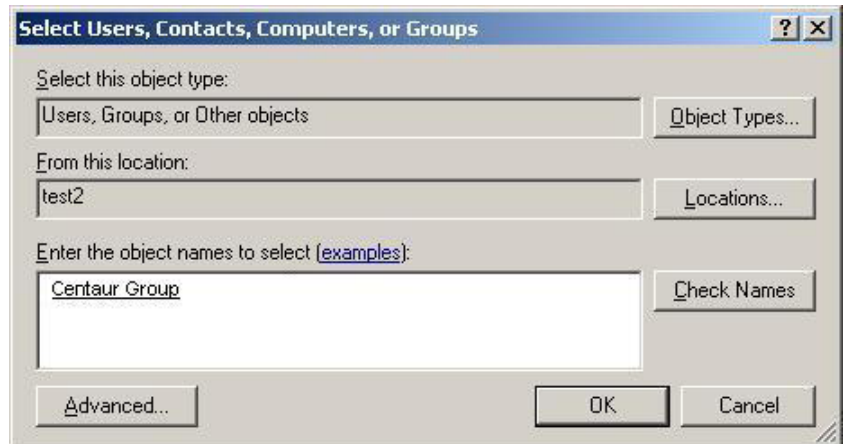

- Select the four check boxes in the **Permissions for Centaur** window and click **OK**.

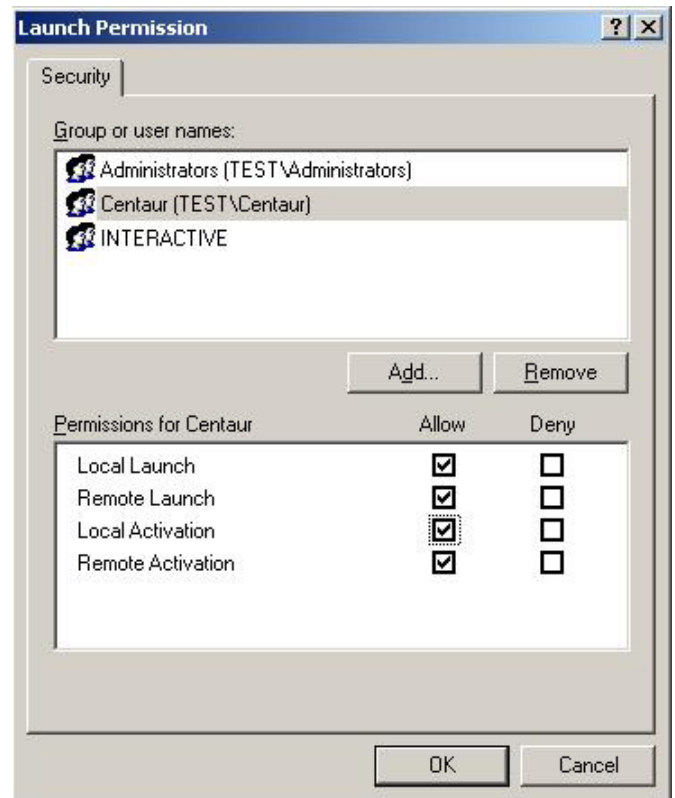

# CENTAUR

## Integrated Access Control V8.0

- In the **Security** tab click on the **Modify** button to change the **Access Permissions** section.

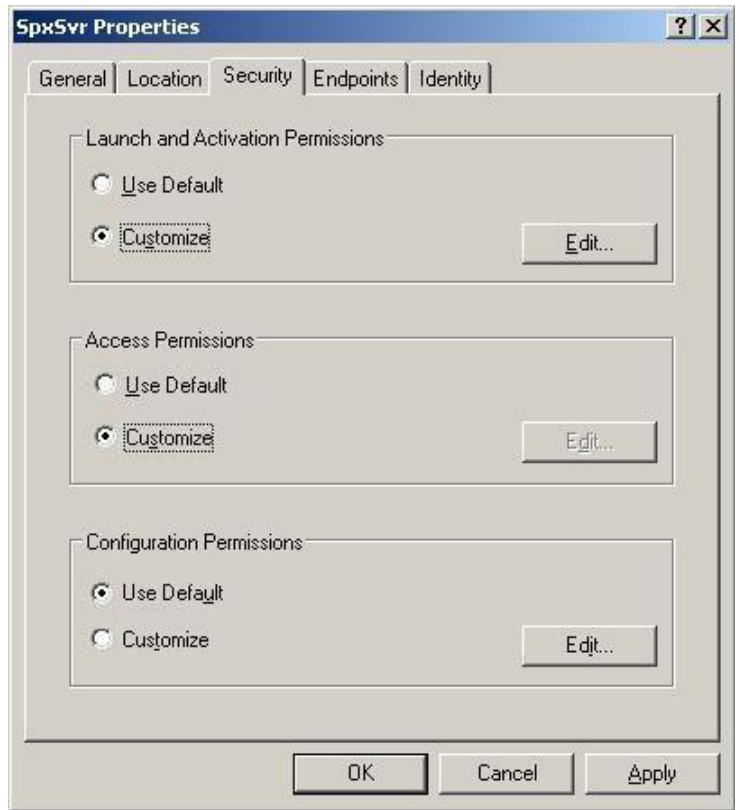

- In the **Select Users, Contacts, Computers or Groups** window type the group's name you have created in the **Enter the Object Names to Select**.

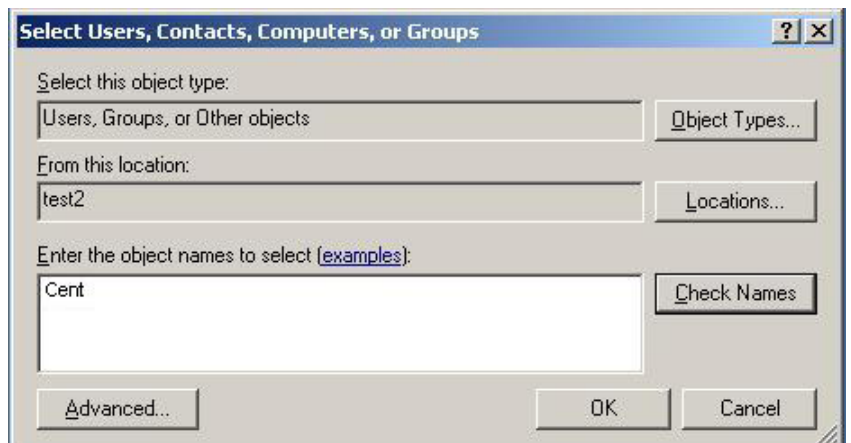

# CENTAUR

## Integrated Access Control V8.0

- 28. Click on the **Check Names** button to validate the name of the group and click **OK**.

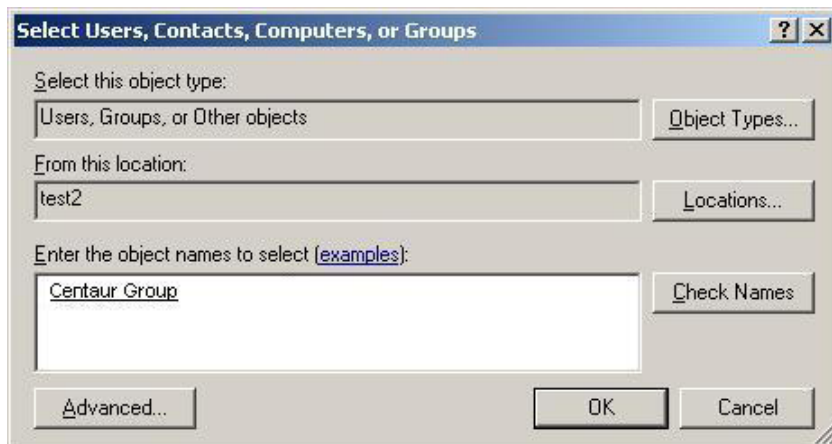

- 29. Select the two **Allow** check boxes in the **Permissions for Centaur** window.

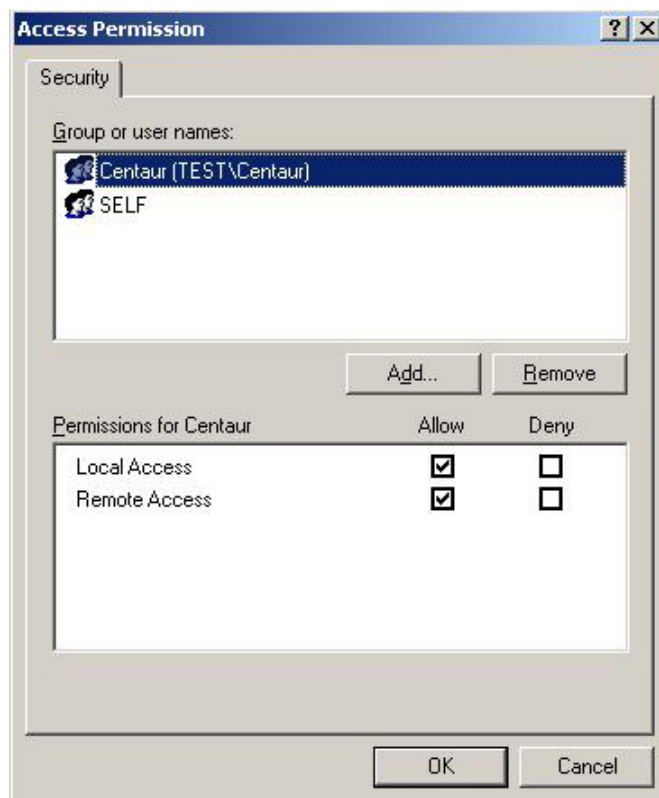

# CENTAUR

## Integrated Access Control V8.0

30. Click the **Identity** tab and select **The interactive user** check box.

If the option is grayed out, close the **SpxSvr Properties** window and go to \Program Files\CDV Americas\Centaur\Centaur Server folder and run the **Reg Centaur.bat** file. This command will deactivate the **auto-start service when the OS starts** for the Centaur Service Manager.

Re-open the **SpxSvr Properties** window (see step #19) and from the **Identity** tab, select **The interactive user** option, and click **OK**.

To reactivate the **auto-start service when the OS starts** for the Centaur Service Manager, run the **service.bat** application from the \Program Files\CDV Americas\Centaur\Centaur Server folder.

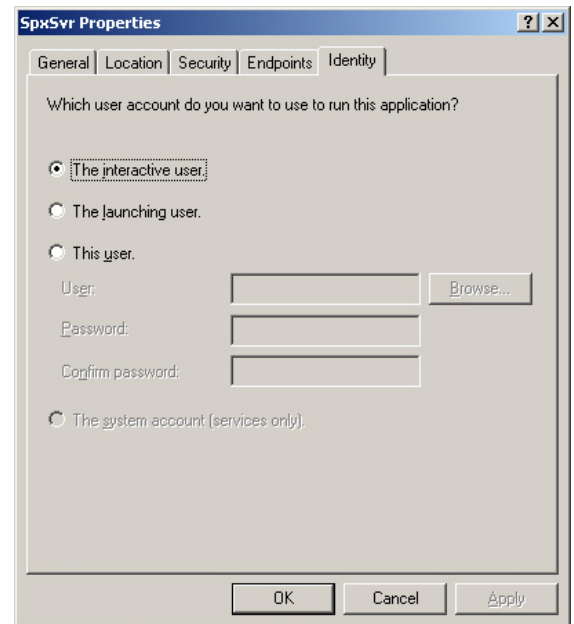

# CENTAUR

## Integrated Access Control V8.0

### Enabling the Network Access

1. From the task bar click on **Start -> Settings -> Configuration Panel -> Administrative Tools -> Local Security Policy.**

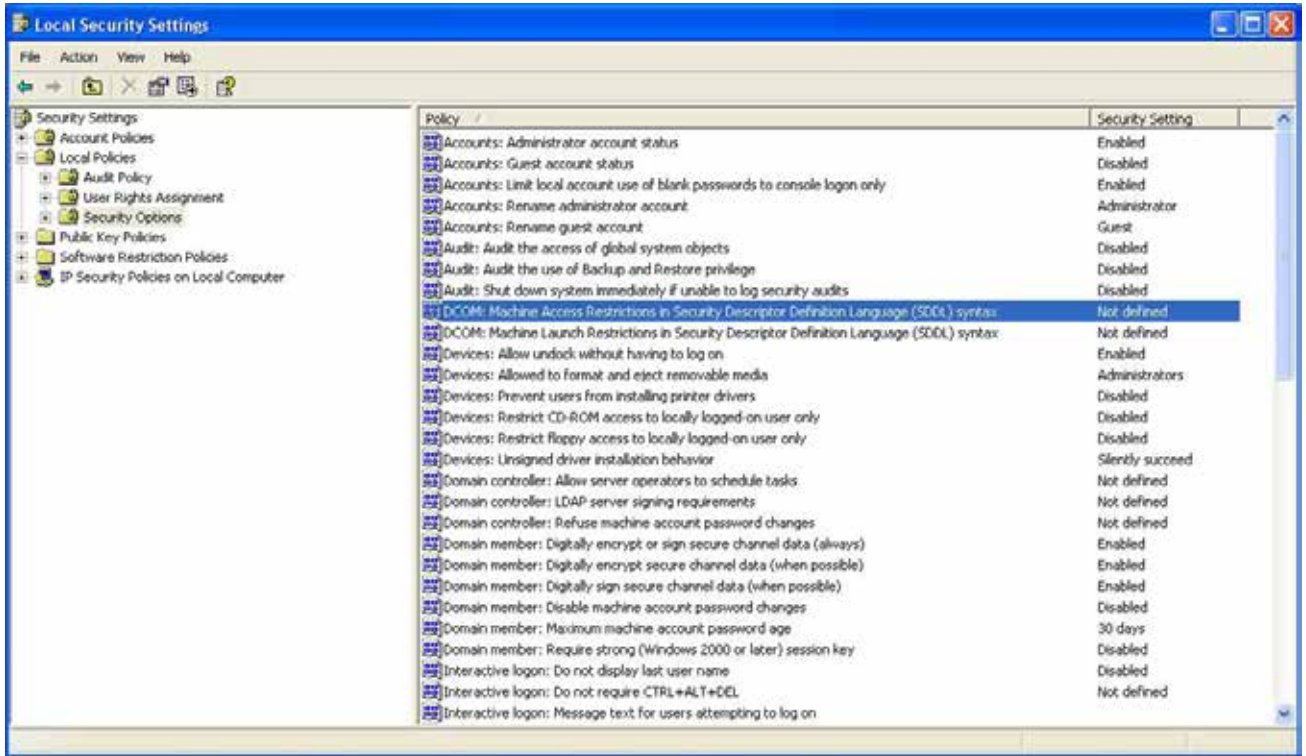

2. The **Local Security Settings** window will pop-up. Expand the **Local Policies** folder to **Security Options** and click on this folder. Double click on the **DCOM: Machine Access Restrictions in Security Descriptor Definition Language (SDDL) syntax**.
3. In the new window click on the **Edit Security ...** button.



# CENTAUR

## Integrated Access Control V8.0

4. Click on the **Add ...** button and select the Centaur group that has been created before. Under **Permissions for Centaur**, check if the two **Allow** check boxes are selected and click **OK**.
5. Redo the step 2 to step 4 for **DCOM: Machine Launch Permissions in Security Descriptor Definition Language (SDDL) syntax**.

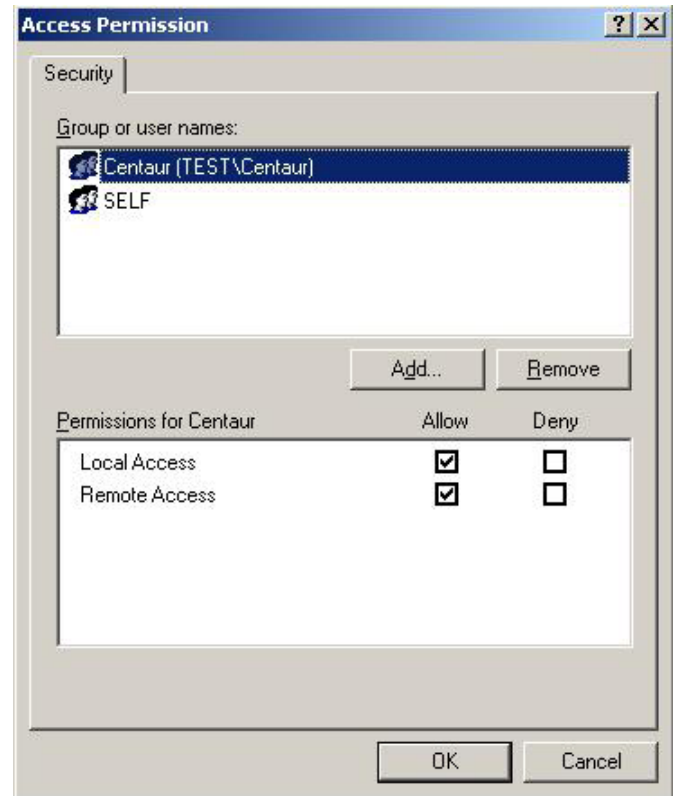

# CENTAUR

## Integrated Access Control V8.0

### DCOM CONFIGURATION FOR WINDOWS 2000 PRO AND SERVER

To be able to configure the DCOM on Windows 2000 operating system, you have to be logged in as **Administrator**.

1. From the taskbar, click **Start -> Run**.
2. In the RUN window type **dcomcnfg.exe**. Click **OK** or press the keyboard **Enter** key.

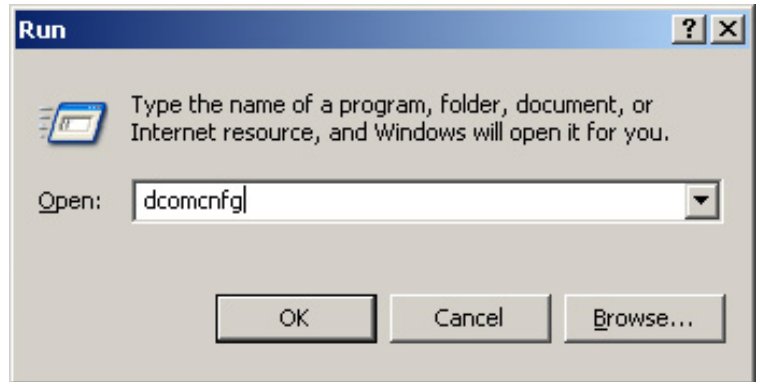

3. The **Distributed COM Configuration Properties** window pops up. Highlight **SpXsvr** from the list and click on **Properties**.

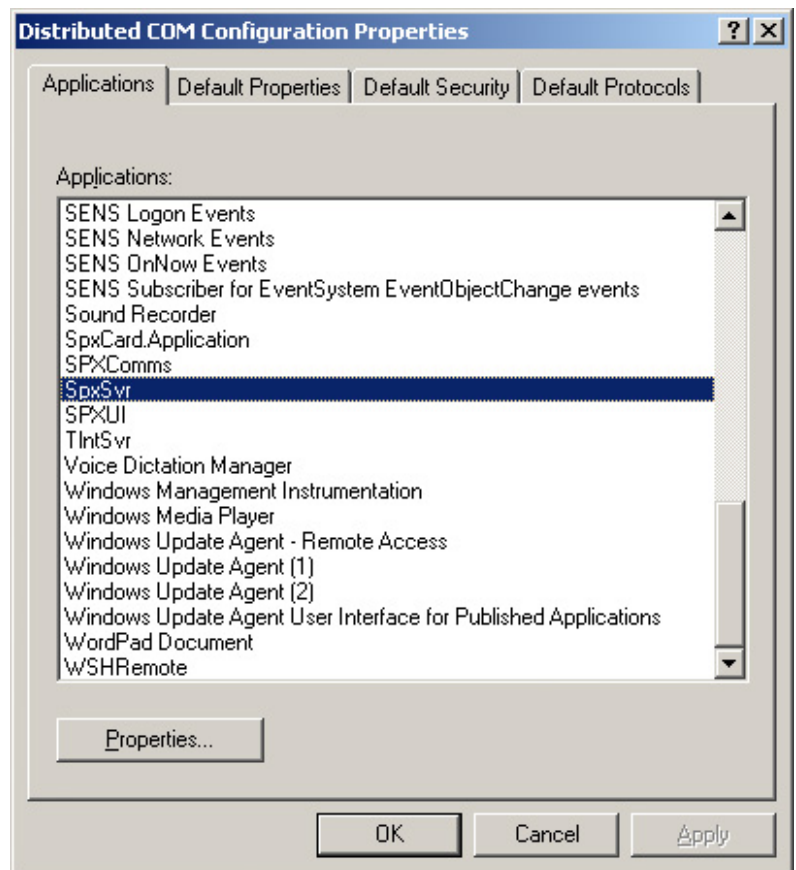

# CENTAUR

## Integrated Access Control V8.0

4. The **SpxSvr Properties** window pops up. In the **Authentication Level** drop-down list, choose **None**.

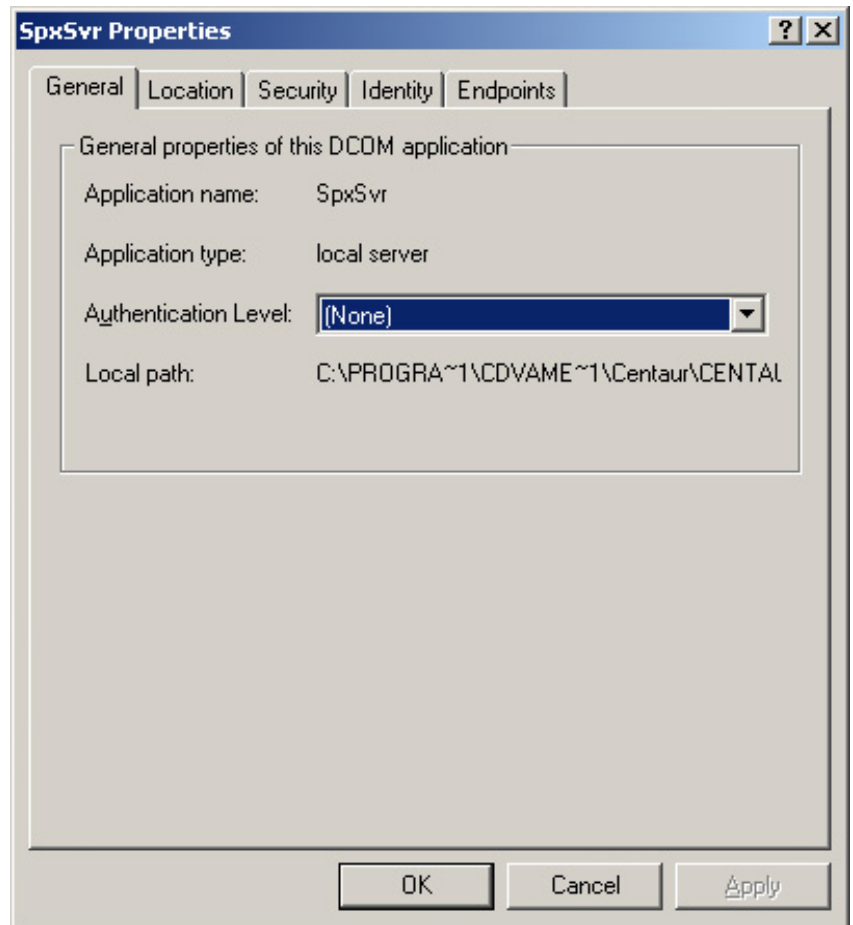

# CENTAUR

## Integrated Access Control V8.0

5. Click on the **Location** tab and select the **Run application on this computer** check box.  
NB: The **Run application on this computer** check box is selected by default.

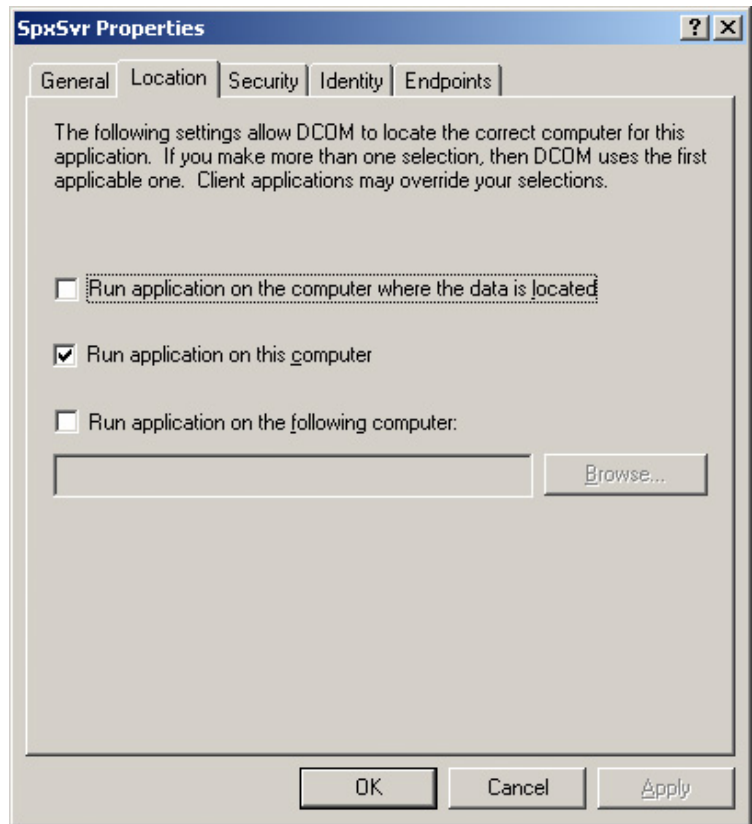

# CENTAUR

## Integrated Access Control V8.0

- Click on the **Identity** tab and select **The interactive user** check box.

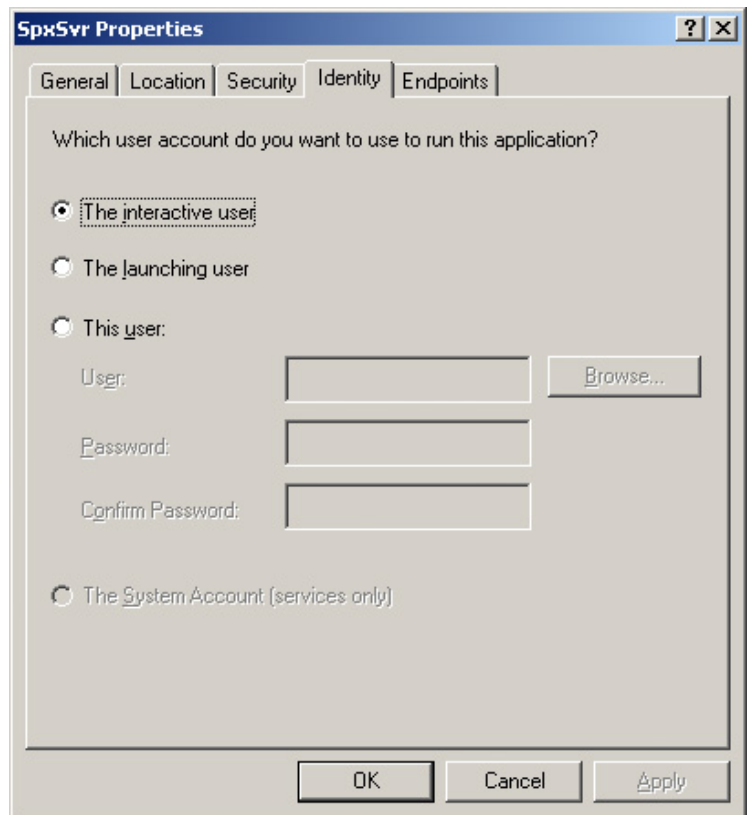

# CENTAUR

## Integrated Access Control V8.0

7. Click the **Security** tab to configure the user(s) that have(s) the right to access the Centaur Server computer. Select the following check boxes:

- **Use custom access permissions**
- **Use default launch permissions**
- **Use custom configuration permissions**

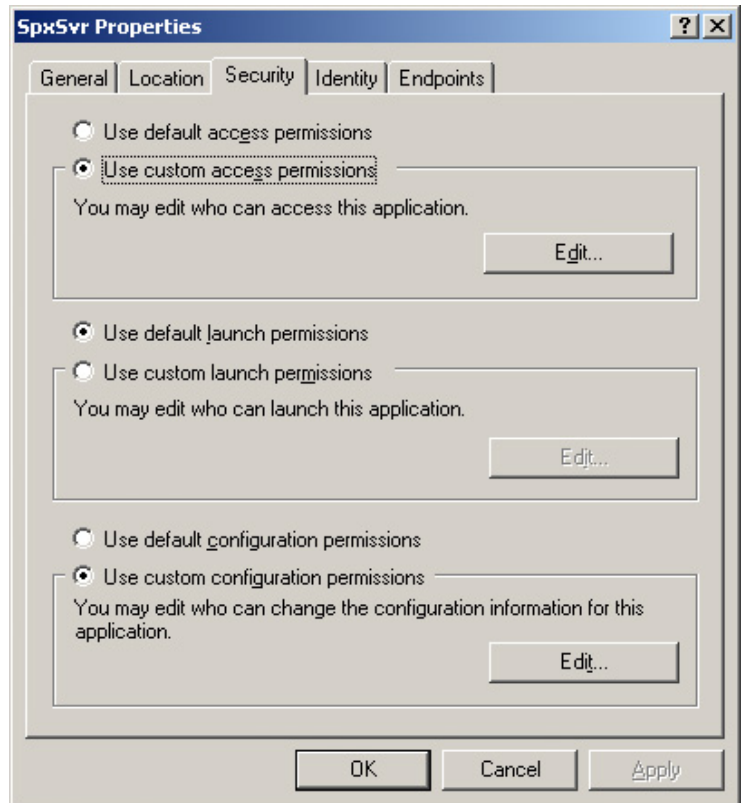

8. Under **Use custom access permissions**, click the **Edit** button.  
 NB: The **Use default launch permissions** and **Use custom configuration permissions** check boxes are selected by default.

9. The **Registry Value Permissions** window pops up. To add users, click on the **Add** button.

The **Use default launch permissions** and **Use custom configuration permissions** check boxes are selected by default.

The **Registry Value Permissions** window may be empty, depending on the previous DCOM configurations.

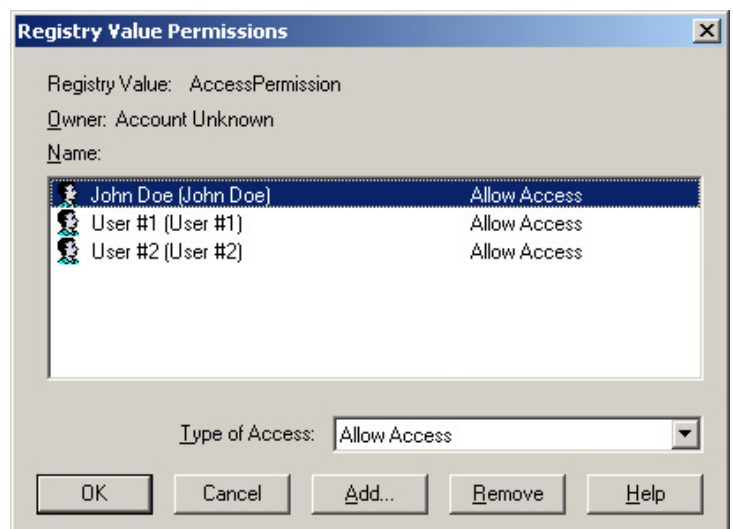

# CENTAUR

## Integrated Access Control V8.0

- The **Add Users and Groups** window pops up on the domain. To view the list of users, either click **Show Users** or if the user is part of a user group, select the group and click **Members**. Select the desired user from the list. Hold down the keyboard **Ctrl** key while left clicking to select multiple users. Click **Add** and **OK**.

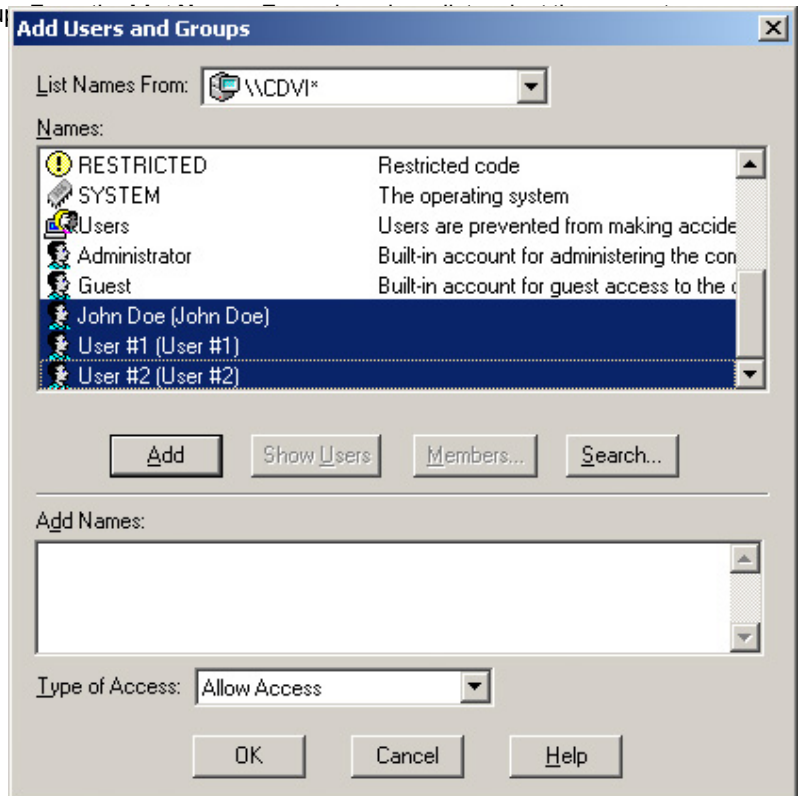

- The selected users will appear in the **Registry Value Permissions** window. Click **OK**.
- Click **Apply** and **OK**.

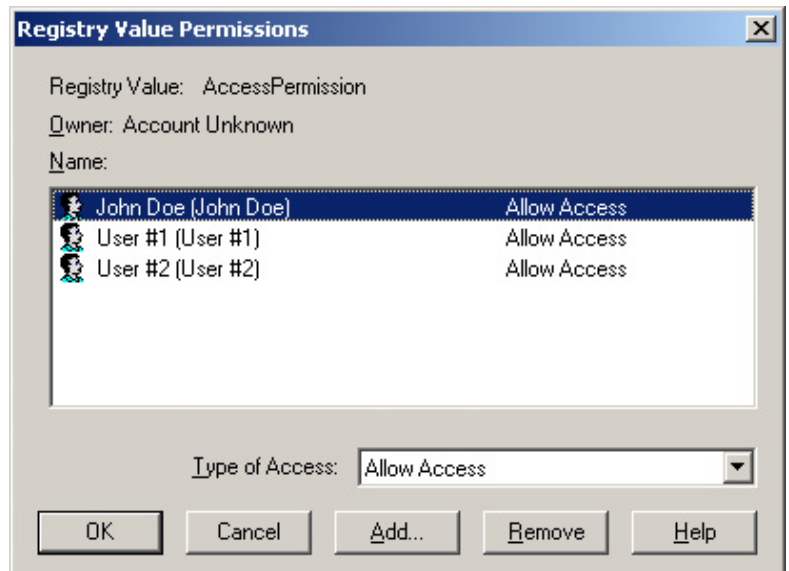

# CENTAUR

## Integrated Access Control V8.0



## Warranty

CDVI Americas Ltd. ("Seller") warrants its products to be free from defects in materials and workmanship under normal use for the period of one year. Except as specifically stated herein, all express or implied warranties whatsoever, statutory or otherwise, including without limitation, any implied warranty of merchantability and fitness for a particular purpose, are expressly excluded. Because Seller does not install or connect the products and because the products may be used in conjunction with products not manufactured by Seller, Seller cannot guarantee the performance of the security system and shall not be responsible for circumstances resulting from the product's inability to operate. Seller obligation and liability under this warranty is expressly limited to repairing or replacing, at Seller's option, any product not meeting the specifications. Returns must include proof of purchase and be within the warranty period. In no event shall the Seller be liable to the buyer or any other person for any loss or damages whether direct or indirect or consequential or incidental, including without limitation, any damages for lost profits, stolen goods or claims by any other party, caused by defective goods or otherwise arising from the improper, incorrect or otherwise faulty installation or use of the merchandise sold.

Notwithstanding the preceding paragraph, the Seller's maximum liability will be strictly limited to the purchase price of the defective product. Your use of this product signifies your acceptance of this warranty.

**BEWARE:** Dealers, installers and/or others selling the product are not authorized to modify this warranty or make additional warranties that are binding on the Seller.

For technical support in Canada or the U.S., call 1-866-610-0102, Monday to Friday from 8:00 a.m. to 8:00 p.m. EST. For technical support outside Canada and the U.S., call 00-1-450-682-7945, Monday to Friday from 8:00 a.m. to 8:00 p.m. EST. Please feel free to visit our website at [www.cdvi.ca](http://www.cdvi.ca).

©2006-2008 CDVI Americas Ltd. All rights reserved. Specifications may change without prior notice. One or more of the following US patents may apply: 6215399, 6111256, 5751803, 5721542, 5287111, 5119069, 5077549, 5920259, 5886632. Canadian and international patents may also apply.

Centaur is a trademark or registered trademark of CDVI Americas Ltd. or its affiliates in Canada, the United States and/or other countries.



**Reference :**  
**Extranet : EXE-CDVI\_IM C8 CMYK A4 EN 06**



**CDVI Group**

FRANCE (Headquarter/Siège social)  
Phone: +33 (0)1 48 91 01 02  
Fax: +33 (0)1 48 91 21 21

**CDVI**

FRANCE + EXPORT  
Phone: +33 (0)1 48 91 01 02  
Fax: +33 (0)1 48 91 21 21

**CDVI AMERICAS**

[CANADA - USA - LATIN AMERICA]  
Phone: +1 (866) 610 0102  
Fax: +1 (450) 682 9590

**CDVI**

BENELUX  
[BELGIUM - NETHERLAND - LUXEMBOURG]  
Phone: +32 (0) 56 73 93 00  
Fax: +32 (0) 56 73 93 05

**CDVI**

TAIWAN  
Phone: +886 (0)42471 2188  
Fax: +886 (0)42471 2131

**CDVI**

SUISSE  
Phone: +41 (0)21 882 18 41  
Fax: +41 (0)21 882 18 42

**CDVI**

CHINA  
Phone: +86 (0)10 62414516  
Fax: +86 (0)10 62414519

**CDVI**

IBÉRICA  
[SPAIN - PORTUGAL]  
Phone: +34 (0)935 390 966  
Fax: +34 (0)935 390 970

**CDVI**

ITALIA  
Phone: +39 0321 90 573  
Fax: +39 335 127 89 96

**CDVI**

MAROC  
Phone: +212 (0)5 22 48 09 40  
Fax: +212 (0)5 22 48 34 69

**CDVI**

SWEDEN  
[SWEDEN - DENMARK - NORWAY - FINLAND]  
Phone: +46 (0)31 760 19 30  
Fax: +46 (0)31 748 09 30

**CDVI**

UK  
[UNITED KINGDOM - IRELAND]  
Phone: +44 (0)1628 531300  
Fax: +44 (0)1628 531003

**CDVI DIGIT**

FRANCE  
Phone: +33 (0)1 41 71 06 85  
Fax: +33 (0)1 41 71 06 86

All the information contained within this document (pictures, drawing, features, specifications and dimensions) could be perceptibly different and can be changed without prior notice. December 2025

*The installer's choice*  
**cdvi.com**