

People
PL6731

COMELIT[®]
WITH • YOU • ALWAYS

FULL TECHNICAL MANUAL

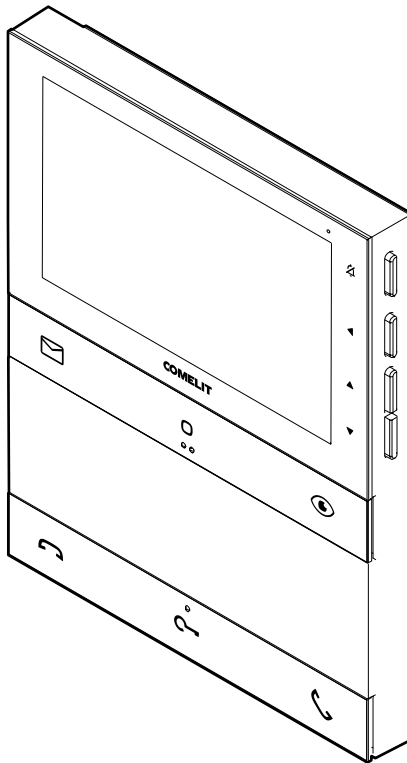

**Join us
in taking care
of our planet**

5" People door entry monitor with video memo art. PL6731 for Simplebus 2 system

People series colour door entry monitor for Simplebus 2 system

Hands-free version with 5" / 16:9 screen.

The door entry monitor can be programmed, even when switched off, via smartphone using the MyComelit app, which is available to download free of charge.

It is supplied with a metal surface mounting backplate for stable and strong fixing, and with a line distribution terminal.

It has 6 mechanical buttons on the front, with icons identifying their factory set functions.

3 of the buttons are backlit to ensure ease of use: green for the 'audio' function, red for the 'end communication' function, and white for the 'electric lock' function.

3 buttons are programmable and pre-configured to display images from the video memory, to control an actuator, and to perform self activation.

The middle buttons of each row have touch guides for sight-impaired users.

On the right-hand side of the door entry monitor there are buttons for activating Silent mode with a red indicator light and corresponding icon, plus buttons for accessing the menu used to adjust the brightness, contrast, colour and ringtone volume values.

It comes as standard with a floor door call that can also be programmed for other functions.

Dimensions (L x H x D): 135 x 170 x 23 mm.



**Think before you
print**

**and use the
interactive links**



Help us to save the planet.

Think of the planet before printing this document.

You are reading an interactive document: quickly access the content you are interested in via links.

Table of contents

Description	4
Front buttons - factory programming	5
Side buttons	6
Activating "Silent mode"	6
Accessing and navigating menus	6
Indicator LEDs	9
Technical specifications	10
Programming the user code	12
Programming the user code via the MyComelit app	12
Programming the user code using the dip-switches	15
Installation	16
Disassembling the door entry monitor	17
Removing and fitting the connection terminals	17
Connections	18
Programming the door entry monitor	19
Programming via installer menu	20
Programming via MyComelit app (vers. 2.0.0 or higher)	29
Expansion diagrams	32
Wiring diagrams	33
System with power supply unit art. 1210/1210A and operating distances	33
System with power supply unit art. 4888C and operating distances	36
Warning	38

Description

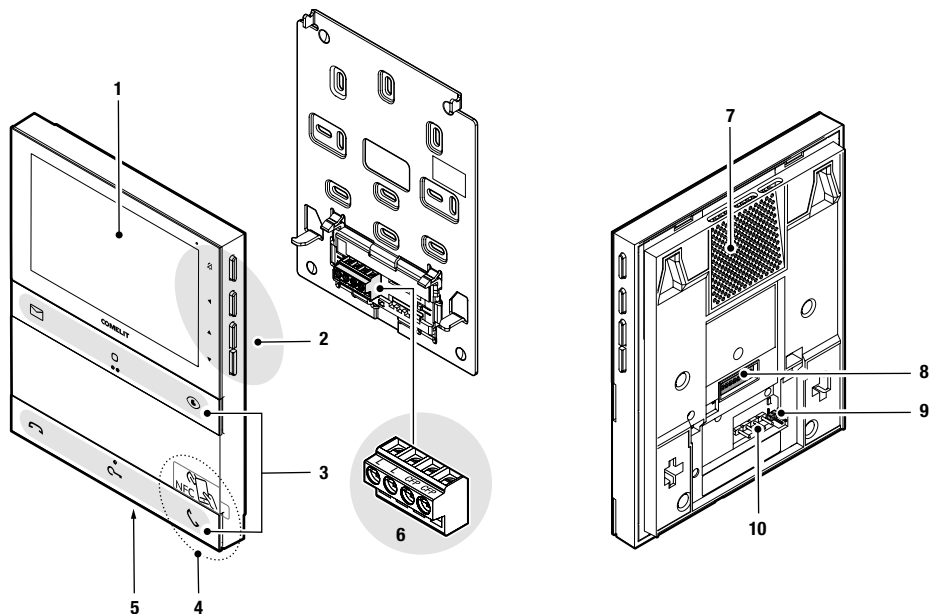

1. 5" / 16:9 LCD screen.
2. Mechanical side buttons.
3. Mechanical front buttons, with touch guides for sight impaired users on the middle buttons of each row.
4. NFC detection area, identified by a removable sticker.
5. Microphone.
6. Connection terminal block:
 - LL** Terminals for bus line connection.
 - CFP CFP** Terminals for floor door call connection.
7. Speaker.
8. Dip-switch for programming the user code.
9. **CV5** Jumper for video closure.
10. Pin for securing the terminal block.

Front buttons - factory programming



Video memo ✳

- ▶ Press the button to view the recorded video.



Generic actuator ✳

- ▶ Press the button to activate a generic actuator (art. 1256) or the relay for the external entrance panel.



Self activation ✳

- ▶ Press the button to access real-time viewing of the images on the external entrance panel camera.



End of communication

- ▶ Press the button to end the audio communication.





Lock-release ✳

- ▶ Press the button to activate the door lock.

Automatic lock-release on receipt of call

This button can also be used to enable "Auto lock-release on receipt of call", which allows automatic activation of the lock-release relay on receipt of a call originating from the external entrance panel.

- √ The function must be authorised by the installer using the MyComelit app or via the installer menu on the door entry monitor.
- ▶ When the door entry monitor is in standby, press  for 5 seconds to enable/disable "Automatic lock-release on receipt of call" mode.
 - » A confirmation tone will play.
 - » The text "AUTO LOCK-RELEASE ACTIVATED/DEACTIVATED" appears on the door entry monitor display for 3 seconds.
 - » The steadily lit LED  indicates that the function is active.





Start communication (speech button)

- ▶ Press the button to activate communication.

Automatic answer

This button can also be used to enable "Automatic answer", which allows automatic activation of the audio on receipt of a call originating from the external entrance panel.

- √ The function must be authorised by the installer using the MyComelit app or via the installer menu on the door entry monitor.
- ▶ When the door entry monitor is in standby, press  for 5 seconds to enable/disable "Automatic answer" mode.
 - » A confirmation tone will play.
 - » The text "AUTOMATIC ANSWER ACTIVATED/DEACTIVATED" appears on the door entry monitor display for 3 seconds.
 - » The steadily lit LED  indicates that the function is active.

✳ To change the factory programming for the buttons, please refer to the chapter [Programming the door entry monitor](#) on page 19.

Side buttons

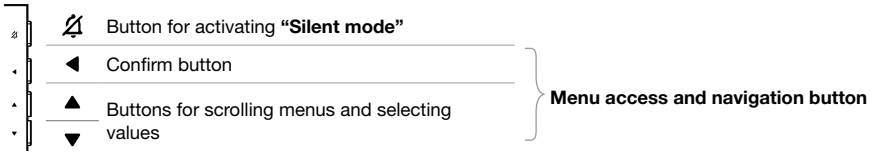

Activating “Silent mode”

- ▶ Press  to activate/deactivate **Silent mode**.
- » *The red LED indicates that the function is active.*

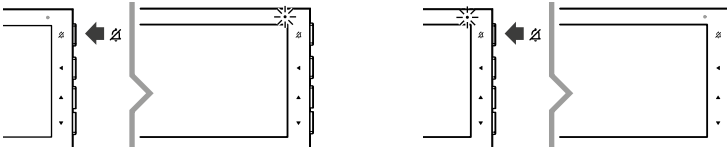

Accessing and navigating menus

- ▶ Press **one** of the following buttons to access the **user menu**.

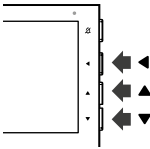

CAUTION

If the red LED flashes 4 times, this means that the system is busy and that the user menu cannot be accessed at this time.









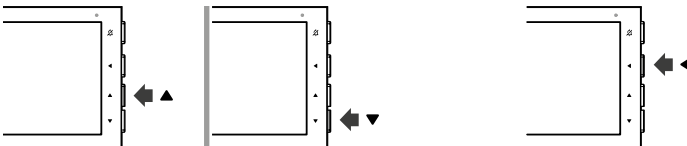











CAUTION

If the  icon appears while you are navigating the user menu and the door entry monitor switches off, this means that the system is busy and you cannot navigate the user menu at this time.

- ▶ Press **▲** and **▼** to scroll through the menu and/or select the values, then press **◀** to confirm the selection.



User menu options



	EXIT	Select this menu to exit the user menu and scan the QR code to access the online documentation.
	VIDEO MEMO	Select this menu to access the log of recordings and to view them (up to 30 video memos can be stored).
	SETTINGS	Select this menu to access the submenus that are used to adjust the following parameters:
	BACK	Select this menu to return to the main menu.
	RINGTONE VOLUME SETTINGS	Select this menu to adjust the ringtone volume.
	RINGTONE SETTINGS	Select this menu to configure the ringtone melody as desired for calls from the external entrance panel.
	AUDIO VOLUME SETTINGS	Select this menu to adjust the speaker volume.
	BRIGHTNESS SETTINGS	Select this menu to adjust the display brightness.
	CONTRAST SETTINGS	Select this menu to adjust the display contrast.
	COLOUR SETTINGS	Select this menu to adjust the display colours.
	SILENT MODE	<p>Select this menu to configure the function activation mode and to program the time bands for operation:</p> <ul style="list-style-type: none"> • MANUAL: in this mode, silent mode activation/deactivation is managed by pressing . • AUTOMATIC: in this mode, silent mode activation/deactivation is managed by means of time bands programmed via the user menu. * <p>» When this mode is active the LED  is lit.</p> <p>√ The function must be authorised by the installer using the MyComelit app or via the installer menu on the door entry monitor.</p> <p>Select this menu to configure the function activation mode and to program the time bands for operation:</p>
	AUTO LOCK-RELEASE	<ul style="list-style-type: none"> • MANUAL: in this mode, auto lock-release activation/deactivation is managed by pressing and holding (5 sec.) . • AUTOMATIC: in this mode, auto lock-release activation/deactivation is managed by means of time bands programmed via the user menu. * <p>» When this mode is active the LED  is lit.</p> <p>√ The function must be authorised by the installer using the MyComelit app or via the installer menu on the door entry monitor.</p> <p>Select this menu to configure the function activation mode and to program the time bands for operation:</p>
	AUTOMATIC ANSWER	<ul style="list-style-type: none"> • MANUAL: in this mode, automatic answer activation/deactivation is managed by pressing and holding (5 sec.) . • AUTOMATIC: in this mode, automatic answer activation/deactivation is managed by means of time bands programmed via the user menu. * <p>» When this mode is active the LED  is lit.</p>

√ The function must be authorised by the installer using the MyComelit app or via the installer menu on the door entry monitor.

Select this menu to configure the function activation mode and to program the time bands for operation:



CALL RANGE

- **MANUAL:** in this mode, call range activation/deactivation is managed by pressing and holding (5 sec.)  and .
 - **AUTOMATIC:** in this mode, call range activation/deactivation is managed by means of time bands programmed via the user menu.
- » When this mode is active the LED  flashes.



DATE AND TIME

Select this menu to configure the date and time.



LANGUAGE

Select this menu to configure the language in which the menus and alert messages will be displayed.







INFORMATION

Select this menu to view information relating to the door entry monitor and scan the QR code to access the online documentation.

★ For information regarding time band programming, please refer to the full online user manual.

Indicator LEDs

	Red LED	Flashing: communication taking place.
		Flashing: incoming call/communication taking place.
	White LED	Flashing with door entry monitor in standby: "Door open" indication. Lit steadily with door entry monitor in standby: "Auto lock-release on receipt of call" mode enabled.
		Flashing: incoming call.
	Green LED	Lit steadily: communication taking place. Lit steadily with door entry monitor in standby: "Automatic answer" mode enabled.
	Red LED	4 flashes: system busy / other door entry monitor in the system on. Lit steadily: silent mode enabled.
	White LED	Flashing: there are recordings which have not yet been viewed.

Technical specifications

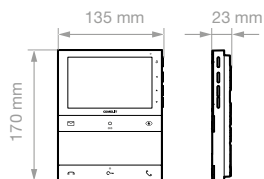

GENERAL DATA	
Product weight	430 grams
Product colour	White RAL9003, Black RAL9005
Coating material type	ABS, PMMA
Surface mounting	Yes
Desk base mounting	Yes, with specific accessory
COMPATIBLE SYSTEMS	
	Simplebus 2 audio/video with power supply unit art. 4888C
	Simplebus 2 audio/video with power supply unit art. 1210/1210A
	Simplebus 2 audio/video kit with power supply unit art. 1209
DISPLAY	
Display size	5"
Type of display	TFT
Aspect ratio	16:9
Resolution (pixels)	800x480
On-screen menu (OSD)	Yes
AUDIO SPECIFICATIONS	
Type	Hands-free
Microphone	6 mm (ø), Omnidirectional
Loudspeaker	36 mm (ø), 40 Ohm, 1W
ELECTRICAL SPECIFICATIONS	
Type of power supply	Power supply via video entry bus
Power supply voltage	33 VDC
Absorption in standby	0.04W
Maximum absorption	9.9W
HARDWARE CHARACTERISTICS	
Type of buttons	Mechanical
Total buttons (no.)	6
Backlighting colour	Green, White, Red
Terminals	L L CFP CFP
Removable terminals	Yes
Number of inputs (no.)	1

SETTINGS	
Loudspeaker volume	Yes
Ringtone volume	Yes
Screen brightness	Yes
Screen contrast	Yes
Screen colour	Yes
NETWORK AND COMMUNICATION PROTOCOL	
User function programming via OSD menu	Yes
Installer function programming via OSD menu	Yes
Function programming via NFC and MyComelit app	Yes
ENVIRONMENTAL AND CONFORMITY SPECIFICATIONS	
IP protection rating	IP30
Operating temperature (°C)	5 - 40 °
Operating humidity (max. RH)	25 - 75 %
Environmental class	I (B1)
CE certification	RoHS II - 2011/65/EU (EN IEC 63000:2018), EMC 2014/30/EU (EN 61000-6-1:2007, EN 61000-6-3:2007+A1:2011)
GENERAL FEATURES	
Lock-release	Yes
Automatic lock-release on receipt of call	Yes
Silent mode	Yes
Self activation	Yes
Switchboard call	Yes
Intercom calls	Yes
Selective intercom call	Yes
Panic call	Yes
Input for floor door call	Yes
Customisable ringtone	Yes
Automatic answer	Yes
Video memo	Yes
Actuator control	Yes
Door open indication	Yes
Acoustic indications	Yes
Visual indications	Yes
Date/time display	Yes

Programming the user code

A user code must be assigned to the door entry monitor. The user code can be programmed via the MyComelit app or using the dip-switches.

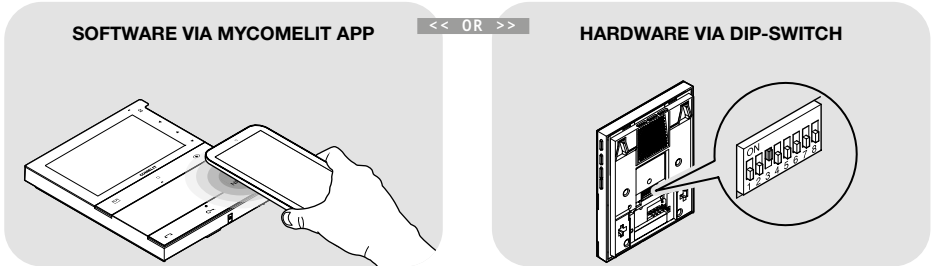

Programming the user code via the MyComelit app

The door entry monitor has an NFC connection which means it can be programmed quickly and easily **via the MyComelit app**, available to download free of charge.



Programming can even take place while the door entry monitor is off, and without removing the device from its packaging! The user code for several door entry monitors can be programmed in sequence!



To program the user code using the MyComelit App, follow the procedure shown in this video tutorial or read the following instructions carefully.

- ✓ All dip-switches must be set to OFF (factory programming) and should remain OFF even during normal operation.

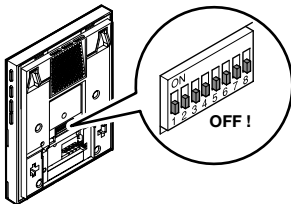

1. Open the MyComelit app and log in (or create a new account if it is the first time you have accessed it).
2. Select "PEOPLE DOOR ENTRY MONITORS SETUP".



3. Enter the desired user code and press "WRITE".

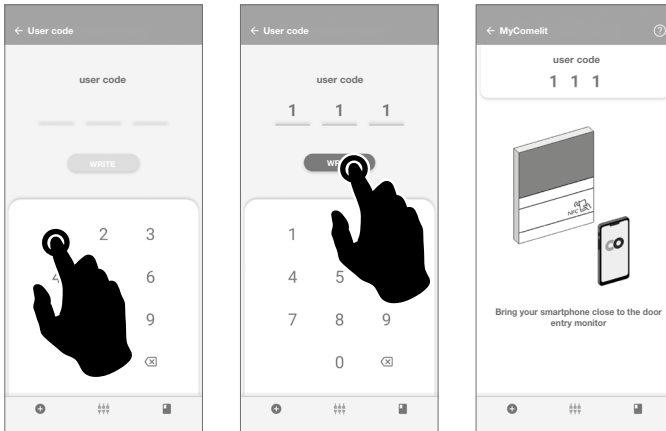

4. Bring your smartphone close to the NFC detection area of the door entry monitor (identified by its label) and make a circular motion until you feel it vibrate.
The vibration indicates that writing is taking place. Hold your smartphone in place until the procedure is complete.

» *A tick indicates that writing was successful.*

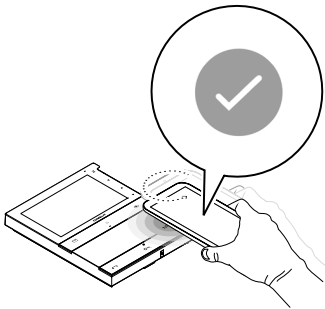

5. **A** Press "END" to end the user code programming procedure on the door entry monitor.



OR

if you want to program the user codes for other door entry monitors in sequence:

5.B Press "CONTINUE".

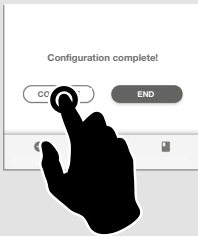

6.B Select the desired increment interval.

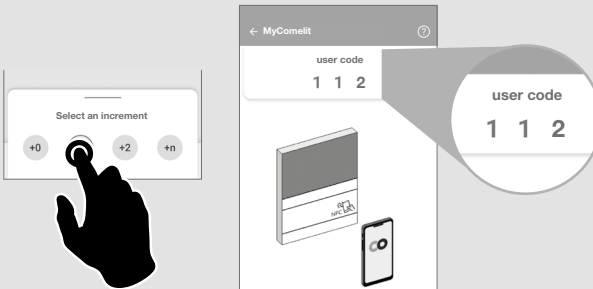

7.B Bring your smartphone close to the NFC detection area of the new door entry monitor (identified by its label) and make a circular motion until you feel it vibrate.

The vibration indicates that writing is taking place. Hold your smartphone in place until the procedure is complete.

» A tick indicates that writing was successful.

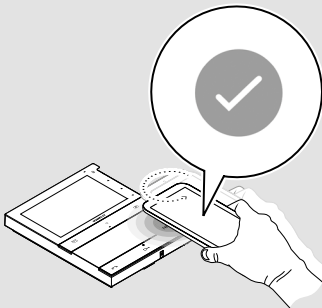

8.B Repeat step 7.B for each door entry monitor on which you want to program the user code.

Programming the user code using the dip-switches

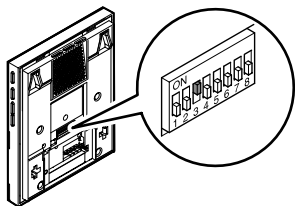

- Set the DIP-switches to **ON** to program a user code on the door entry monitor, as per Table of user codes.

Example: code 4.

TABLE OF USER CODES

code	DIP ON															
1	1	31	1,2,3,4,5	61	1,3,4,5,6	91	1,2,4,5,7	121	1,4,5,6,7	151	1,2,3,5,8	181	1,3,5,6,8	211	1,2,5,7,8	
2	2	32	6	62	2,3,4,5,6	92	3,4,5,7	122	2,4,5,6,7	152	4,5,8	182	2,3,5,6,8	212	3,5,7,8	
3	1,2	33	1,6	63	1,2,3,4,5,6	93	1,3,4,5,7	123	1,2,4,5,6,7	153	1,4,5,8	183	1,2,3,5,6,8	213	1,3,5,7,8	
4	3	34	2,6	64	7	94	2,3,4,5,7	124	3,4,5,6,7	154	2,4,5,8	184	4,5,6,8	214	2,3,5,7,8	
5	1,3	35	1,2,6	65	1,7	95	1,2,3,4,5,7	125	1,3,4,5,6,7	155	1,2,4,5,8	185	1,4,5,6,8	215	1,2,3,5,7,8	
6	2,3	36	3,6	66	2,7	96	6,7	126	2,3,4,5,6,7	156	3,4,5,8	186	2,4,5,6,8	216	4,5,7,8	
7	1,2,3	37	1,3,6	67	1,2,7	97	1,6,7	127	1,2,3,4,5,6,7	157	1,3,4,5,8	187	1,2,4,5,6,8	217	1,4,5,7,8	
8	4	38	2,3,6	68	3,7	98	2,6,7	128	8	158	2,3,4,5,8	188	3,4,5,6,8	218	2,4,5,7,8	
9	1,4	39	1,2,3,6	69	1,3,7	99	1,2,6,7	129	1,8	159	1,2,3,4,5,8	189	1,3,4,5,6,8	219	1,2,4,5,7,8	
10	2,4	40	4,6	70	2,3,7	100	3,6,7	130	2,8	160	6,8	190	2,3,4,5,6,8	220	3,4,5,7,8	
11	1,2,4	41	1,4,6	71	1,2,3,7	101	1,3,6,7	131	1,2,8	161	1,6,8	191	1,2,3,4,5,6,8	221	1,3,4,5,7,8	
12	3,4	42	2,4,6	72	4,7	102	2,3,6,7	132	3,8	162	2,6,8	192	7,8	222	2,3,4,5,7,8	
13	1,3,4	43	1,2,4,6	73	1,4,7	103	1,2,3,6,7	133	1,3,8	163	1,2,6,8	193	1,7,8	223	1,2,3,4,5,7,8	
14	2,3,4	44	3,4,6	74	2,4,7	104	4,6,7	134	2,3,8	164	3,6,8	194	2,7,8	224	6,7,8	
15	1,2,3,4	45	1,3,4,6	75	1,2,4,7	105	1,4,6,7	135	1,2,3,8	165	1,3,6,8	195	1,2,7,8	225	1,6,7,8	
16	5	46	2,3,4,6	76	3,4,7	106	2,4,6,7	136	4,8	166	2,3,6,8	196	3,7,8	226	2,6,7,8	
17	1,5	47	1,2,3,4,6	77	1,3,4,7	107	1,2,4,6,7	137	1,4,8	167	1,2,3,6,8	197	1,3,7,8	227	1,2,6,7,8	
18	2,5	48	5,6	78	2,3,4,7	108	3,4,6,7	138	2,4,8	168	4,6,8	198	2,3,7,8	228	3,6,7,8	
19	1,2,5	49	1,5,6	79	1,2,3,4,7	109	1,3,4,6,7	139	1,2,4,8	169	1,4,6,8	199	1,2,3,7,8	229	1,3,6,7,8	
20	3,5	50	2,5,6	80	5,7	110	2,3,4,6,7	140	3,4,8	170	2,4,6,8	200	4,7,8	230	2,3,6,7,8	
21	1,3,5	51	1,2,5,6	81	1,5,7	111	1,2,3,4,6,7	141	1,3,4,8	171	1,2,4,6,8	201	1,4,7,8	231	1,2,3,6,7,8	
22	2,3,5	52	3,5,6	82	2,5,7	112	5,6,7	142	2,3,4,8	172	3,4,6,8	202	2,4,7,8	232	4,6,7,8	
23	1,2,3,5	53	1,3,5,6	83	1,2,5,7	113	1,5,6,7	143	1,2,3,4,8	173	1,3,4,6,8	203	1,2,4,7,8	233	1,4,6,7,8	
24	4,5	54	2,3,5,6	84	3,5,7	114	2,5,6,7	144	5,8	174	2,3,4,6,8	204	3,4,7,8	234	2,4,6,7,8	
25	1,4,5	55	1,2,3,5,6	85	1,3,5,7	115	1,2,5,6,7	145	1,5,8	175	1,2,3,4,6,8	205	1,3,4,7,8	235	1,2,4,6,7,8	
26	2,4,5	56	4,5,6	86	2,3,5,7	116	3,5,6,7	146	2,5,8	176	5,6,8	206	2,3,4,7,8	236	3,4,6,7,8	
27	1,2,4,5	57	1,4,5,6	87	1,2,3,5,7	117	1,3,5,6,7	147	1,2,5,8	177	1,5,6,8	207	1,2,3,4,7,8	237	1,3,4,6,7,8	
28	3,4,5	58	2,4,5,6	88	4,5,7	118	2,3,5,6,7	148	3,5,8	178	2,5,6,8	208	5,7,8	238	2,3,4,6,7,8	
29	1,3,4,5	59	1,2,4,5,6	89	1,4,5,7	119	1,2,3,5,6,7	149	1,3,5,8	179	1,2,5,6,8	209	1,5,7,8	239	1,2,3,4,6,7,8	
30	2,3,4,5	60	3,4,5,6	90	2,4,5,7	120	4,5,6,7	150	2,3,5,8	180	3,5,6,8	210	2,5,7,8	240*	5,6,7,8	

* Code 240 is reserved for the porter switchboard.

Installation

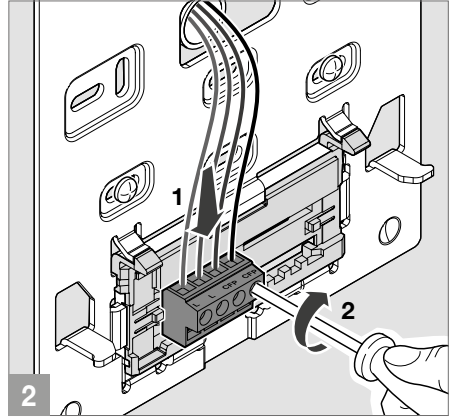
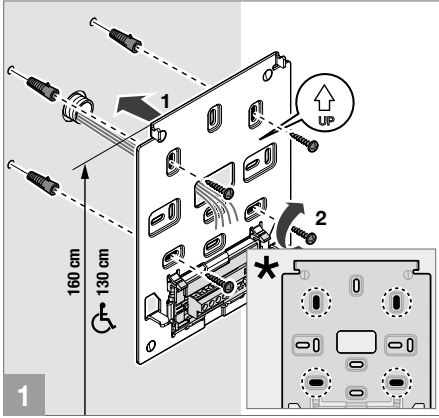

* Fixing points for use when installing in compatible boxes

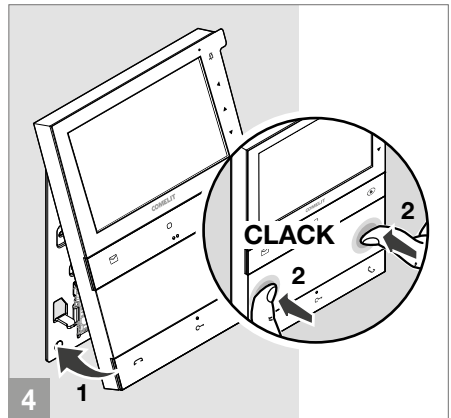
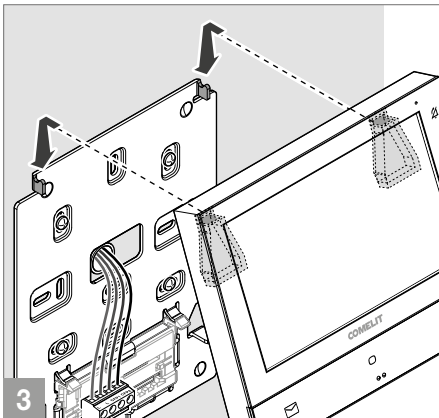
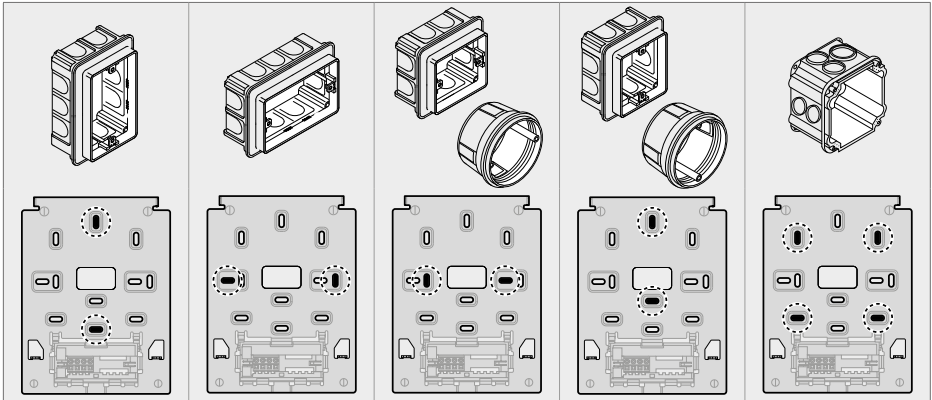

Disassembling the door entry monitor

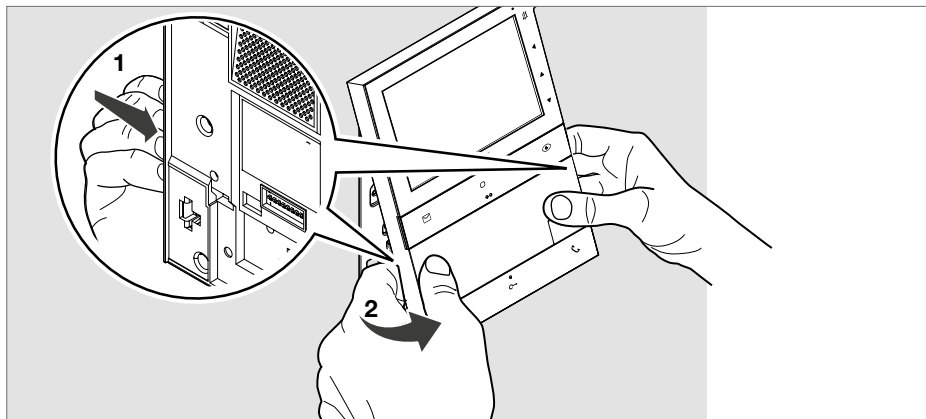

Removing and fitting the connection terminals

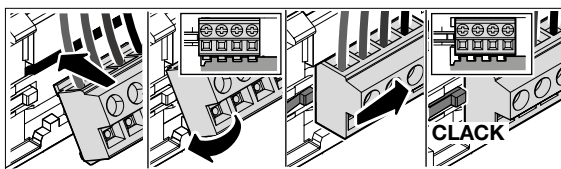
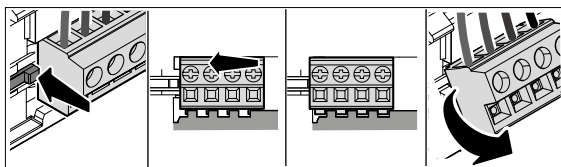
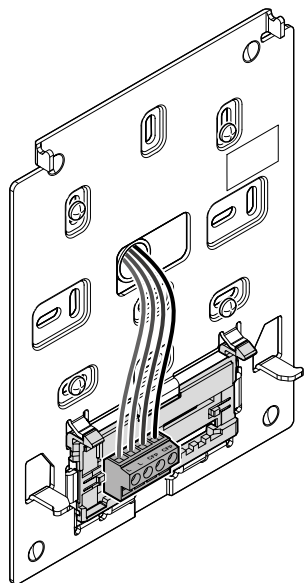

Connections

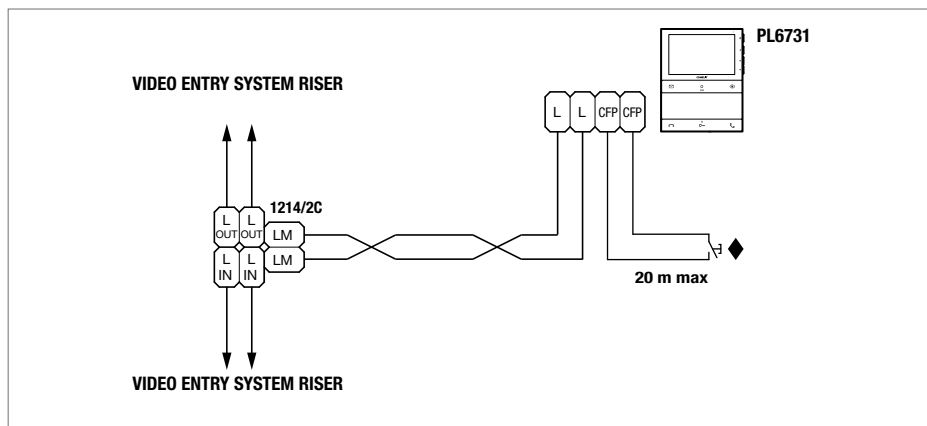

◆ CFP floor door call input

Where multiple door-entry phones or door entry monitors have the same user code, connect the CFP button on one only; all the devices will ring simultaneously.

Programming the door entry monitor

The programming can be customised:

- Using the **MyComelit app** via a smartphone
- Using the **installer menu** on the door entry monitor



Programming via installer menu

√ The first time the door entry monitor is switched on, you will need to configure the device language; you will also be able to set the date and time if necessary.

1. Press **one** of the following buttons to access the **user menu**.

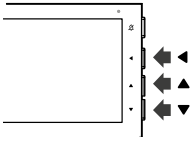

2. Press **▲** and **▼** for 5 sec to access the **installer menu**.

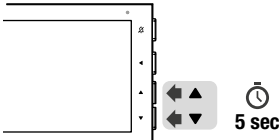

» A confirmation tone will sound and the following screen will appear.

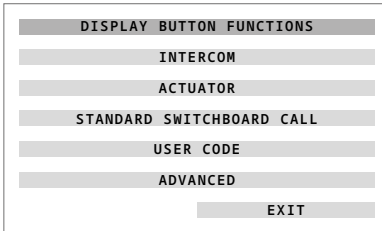

CAUTION

If the red LED flashes 4 times, this means that the system is busy and that the user/installer menu cannot be accessed at this time.



CAUTION

If the hourglass icon appears while you are navigating the user menu and the door entry monitor switches off, this means that the system is busy and you cannot navigate the user menu at this time.

3. Press **▲** and **▼** to scroll through the menu and/or select the values.

Press **◀** to confirm the selection.

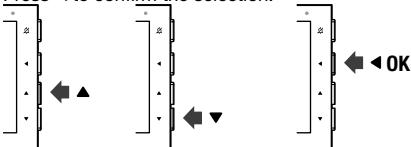

» When the element is selected, the text will turn green.

4. To exit the installer menu, select **EXIT** or wait for 2 minutes (time-out period) without doing anything.

DISPLAY BUTTON FUNCTIONS MENU

By selecting this menu, the functions currently assigned to the buttons on the door entry monitor are displayed. The factory-set functions are as follows:

← BACK	
PROGRAMMED FUNCTION	BUTTON
VIDEO MEMO	✉
GENERIC ACTUATOR	○
SELF-ACTIVATION	👁
LOCK-RELEASE	↶
FLOOR DOOR CALL	CFP

EXAMPLE: PROGRAMMING THE INTERCOM FUNCTION TO OTHER APARTMENT

1. Press **one** of the following buttons to access the **user menu**.

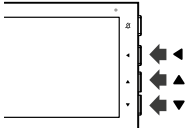

2. Press **▲** and **▼** for 5 sec to access the **installer menu**.

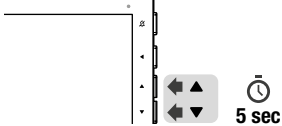

» A confirmation tone will sound and the following screen will appear.

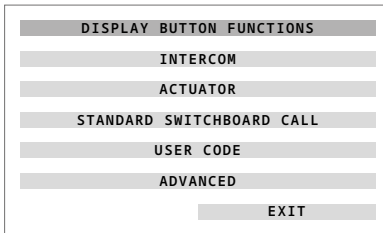

3. Press **▼** to select the **INTERCOM** function

» The menu will turn green.

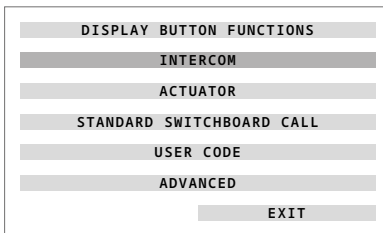

4. Press the confirm button.

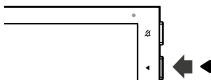

» The following window will appear.

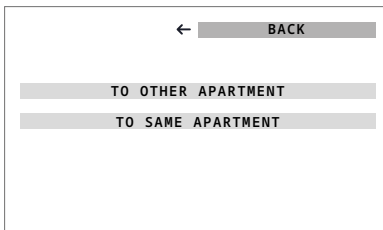

5. Press ▼ to select **TO OTHER APARTMENT**.

» *The menu will turn green.*

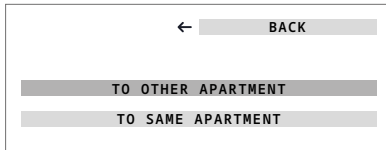

6. Press the confirm button.



7. Press ▼ to select the number you want to change.

» *The checkbox will turn green.*



8. Press the confirm button.



» *Two arrows will appear to indicate the number that can be changed.*



9. Use ▲ and ▼ to set the desired value (example: [3]).



10. Press the confirm button.



11. Press ▼ to select **CONFIRM**.

» *The menu will turn green.*

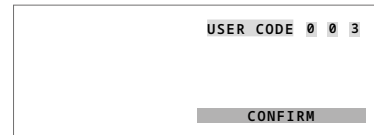

12. Press the confirm button.



13. Press the button to be associated with the function.

If  is configured to activate another function, the MyComelit app should be used to restore the video memo function.

EXAMPLE: PROGRAMMING THE INTERCOM FUNCTION TO SAME APARTMENT

1. Press **one** of the following buttons to access the **user menu**.

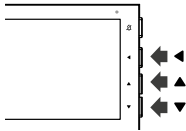

2. Press **▲** and **▼** for 5 sec to access the **installer menu**.

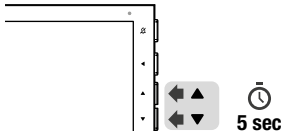

» A confirmation tone will sound and the following screen will appear.

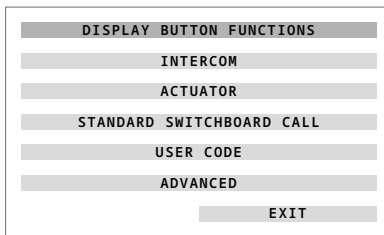

3. Press **▼** to select the **INTERCOM** function

» The menu will turn green.

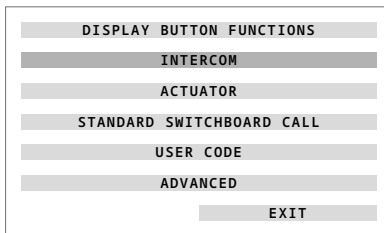

4. Press the confirm button.



» The following window will appear.

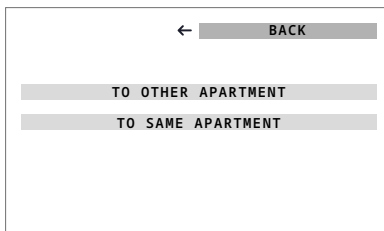

5. Press ▼ to select **TO SAME APARTMENT..**

» *The menu will turn green.*

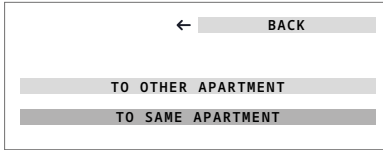

6. Press the confirm button.

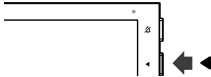

7. Press the button to be associated with the function.

If  is configured to activate another function, the MyComelit app should be used to restore the video memo function.

INSTALLER MENU NAVIGATION TREE

DISPLAY BUTTON FUNCTIONS

Select this menu to view the functions currently assigned to the buttons on the door entry monitor.

← BACK	
PROGRAMMED FUNCTION	BUTTON
VIDEO MEMO	✉
GENERIC ACTUATOR	○
SELF-ACTIVATION	👁
LOCK-RELEASE	🔓
FLOOR DOOR CALL	CFP

INTERCOM

Select this menu to configure the intercom call To same (your own) apartment or To other apartment.

TO OTHER APARTMENT

USER CODE 0 0 1

TO SAME APARTMENT

ACTUATOR

Select this menu to configure a button or the CFP input to control a generic actuator or an actuator with code.

GENERIC

PAIR WITH BUTTON

PAIR WITH CFP INPUT

WITH CODE

CODE

PAIR WITH BUTTON

PAIR WITH CFP INPUT

STANDARD SWITCHBOARD CALL

Select this menu to configure a button to make the call to standard porter switchboard.

USER CODE

Select this menu to configure the door entry monitor user code.

CURRENT USER CODE

USER CODE



ADVANCED

Select this menu to access the advanced settings.

DATE FORMAT

Select this menu to configure the date display format.

DD/MM/YYYY

MM/DD/YYYY

YYYY/MM/DD

MAIN/SECONDARY

Select this menu to configure the door entry monitor as Main (default) or Secondary.

SECONDARY

MAIN

SET RINGTONE

Select this menu to configure the ringtone melodies for floor door call (CFP), call from switchboard, intercom call or call with range.

FLOOR DOOR CALL (CFP)

(1/4)

CALL FROM SWITCHBOARD

(1/7)

INTERCOM CALL

(1/7)

CALL WITH RANGE

(1/7)

SELECTIVE INTERCOM

Select this menu to configure Selective intercom or Selective group call on the buttons.

INTERCOM CODE

PROGRAMMING

CANCELLING

SELECTIVE

INTERCOM CODE

SELECTIVE GROUP

INTERCOM CODE

INTERCOM CODE

INTERCOM CODE

INTERCOM CODE

SELF-ACTIVATION

Select this menu to configure a button to perform self-activation.

STAND-ALONE CAMERA MODULE

Select this menu to configure buttons to control a generic stand-alone camera module or a stand-alone camera module with code.

GENERIC

CODE 220

CODE 221

OTHER CODES

CODE



PANIC CALL

Select this menu to configure a button or the CFP input to transmit a priority call to the porter switchboard.

PAIR WITH BUTTON**PAIR WITH CFP INPUT****SWITCHBOARD CALL**

Select this menu to configure a button to make the call to standard or main porter switchboard.

MAIN**STANDARD****NO FUNCTION**

Select this menu to cancel the function configured on the button.

AUTO LOCK-RELEASE

Select this menu to Authorise/Not authorise the function.

STATUS: AUTHORISED**STATUS: NOT AUTHORISED****AUTOMATIC ANSWER**

Select this menu to Authorise/Not authorise the function.

STATUS: AUTHORISED**STATUS: NOT AUTHORISED****FLOOR DOOR CALL**

Select this menu to configure the CFP input to transmit a floor door call (default) if it had previously been configured for another function.

PAIR WITH CFP INPUT**LOCK-RELEASE**

Select this menu to configure the lock-release function on the CFP input or on the  button (default) if it was previously configured for another function.

PAIR WITH BUTTON**PAIR WITH CFP INPUT****CALL RANGE PROGRAMMING**

Select this menu to Authorise/Not authorise the function and configure the Minimum/Maximum user codes.

STATUS: AUTHORISED**STATUS: NOT AUTHORISED****MINIMUM USER CODE****MAXIMUM USER CODE****DISABLE MENU**

Select this menu to disable the installer menu, or both the user menu and the installer menu, on the door entry monitor. From the moment the installer menu is disabled, the door entry monitor can only be configured via the MyComelit app.

INSTALLER**USER + INSTALLER****INFORMATION**

Select this menu to view information relating to the door entry monitor and scan the QR code to access the online documentation.

FACTORY RESET

Select this menu to restore all configurations to their factory values.

CONFIRM RESET

Programming via MyComelit app (vers. 2.0.0 or higher)

The MyComelit app can be used to program the door entry monitor quickly and easily, even while it is switched off.

When the MyComelit app is used to configure the door entry monitor, the language, date and time are set automatically.

The MyComelit app makes it possible to:

- Read all door entry monitor programming.
- Edit and rewrite the programming.
- Create programming offline, save it to your smartphone and then write it on the door entry monitor later.
- Create and save your favourite programming to your smartphone.
- Increase the user code by a configurable value to allow the programming of door entry monitors in sequence.
- Copy the programming of one door entry monitor to another door entry monitor.
- Share the door entry monitor programming with other users (via WhatsApp, etc.) to facilitate technical support.
- ...

In addition to these functions, the MyComelit app can also be used for the following functions:



- To program the user code (only if it has not been programmed using the DIP-switches, see [Programming the user code via the MyComelit app on page 12](#)).
- To program the functions to be associated with the buttons.
- To program the door entry monitor as main/secondary (see [Main and Secondary Door Entry Monitor on page 30](#)).
- To change the ringtones for:
 - Call from external entrance panel.
 - Floor door call (CFP)
 - Call from switchboard.
 - Intercom call.
 - Call with range.
- To change the functions associated with the CFP input (see [Functions associated with the CFP input on page 31](#)).
- To program the following functions:
 - Intercom (see [Intercom on page 30](#)).
 - Selective intercom (see [Selective intercom on page 30](#)).
 - Selective group intercom (see [Selective group intercom on page 31](#)).
- To authorise the user to utilise the following functions:
 - “Door opening upon call” (see [Automatic lock-release on receipt of call on page 5](#)).
 - “Automatic answer” (see [Automatic answer on page 5](#)).
- To program the minimum and maximum call codes for the call range function (see [Call range on page 31](#)).
- To disable the user and/or installer menu on the door entry monitor.
- Disable the “Silent Mode” button or select the ringtones to silence.
- To restore the door entry monitor to its factory programming.

MAIN AND SECONDARY DOOR ENTRY MONITOR

In systems with power supply unit art. **1210/1210A**, one main door entry monitor and 3 secondary door entry monitors can be programmed for each apartment.

In systems with power supply unit art. **4888C**, 2 main door entry monitors and 2 secondary door entry monitors can be programmed for each apartment.

On receipt of a call from the entrance panel:

- » All door entry monitors ring.
- » The image from the entrance panel appears automatically on the main door entry monitor. Any other secondary door entry monitors in the same family unit will remain off.
- » Video can be requested on the secondary door entry monitor(s) (without answering the call) by pressing the button programmed for self activation (factory set as button ) or by pressing "Start communication" .

INTERCOM FUNCTION

Various types of intercom call can be programmed:

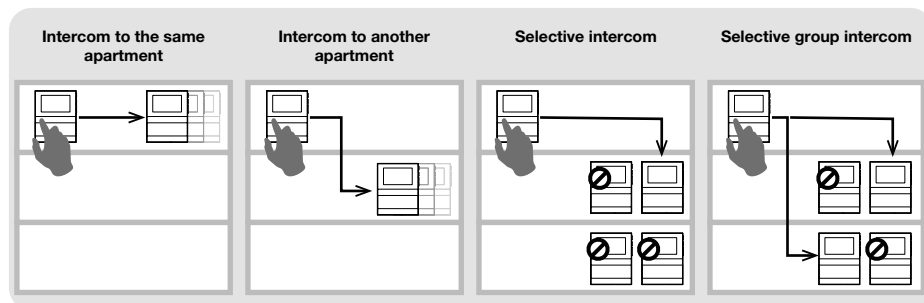

INTERCOM

- **intercom call to the same apartment**

- ▶ Program the **INTERCOM TO SAME APARTMENT** function to the chosen button in order to call ALL the door entry monitors in the same apartment.

- **intercom call to another apartment**

- ▶ Program the **INTERCOM TO OTHER APARTMENT** function to the chosen button in order to call ALL the door entry monitors in that apartment.

SELECTIVE INTERCOM

- **Selective intercom**

- ▶ This is an intercom call to a single door entry monitor in the same apartment or another apartment identified by a dedicated intercom code, different from the user code. ONLY that door entry monitor will be called. The intercom code can be programmed from 1 to 8. The same intercom code can be associated with up to 3 door entry monitors.

NOTE: if even a single user programs this function, the intercom code must be programmed on all door entry monitors on the riser, even if they do not use the function!

1. Program the **INTERCOM CODE** on the door entry monitor you want to call.
2. On the desired button, program the **SELECTIVE INTERCOM** function for the **INTERCOM CODE** of the door entry monitor you want to call.

- **Selective group intercom**

This is an intercom call to groups of several door entry monitors in the same apartment or another apartment identified by a dedicated intercom code, different from the user code. The door entry monitor button can be programmed with up to 3 different intercom codes to which the call will be made at once. The maximum number of door entry monitors which can ring simultaneously nevertheless remains 3.

1. Program the **INTERCOM CODE** on the door entry monitors you want to call.
2. On the desired button, program the **SELECTIVE GROUP INTERCOM** function for the intercom codes of the door entry monitors you want to call.

NOTE:

intercom and selective intercom CANNOT be programmed in the same system!

FUNCTIONS ASSOCIATED WITH THE CFP INPUT

In addition to the floor door call, other functions can be associated with the CFP input (CFP and CFP terminals):

- Control of a generic actuator or with a code.
- Panic call (priority call to porter switchboard).
- Remote control of lock-release command.

CALL RANGE

The door entry monitor can be programmed to receive calls originating from the external entrance panel and direct calls, to both your own user code and an interval (range) of user codes.



Example:

If the door entry monitor is programmed with user code "1" and the range of user codes from 5 to 7 is also programmed, when the function is enabled it will receive both direct calls to user code "1" and direct calls to user codes 5, 6 and 7.





√ **The user can only activate/deactivate the range of user codes if they have been authorised to do so by the installer, using the MyComelit app or via the installer menu on the door entry monitor.**

Range activation:

- ▶ Press and hold buttons  and  together for 5 seconds.
 - » A confirmation tone will play.
 - » The text "CALL RANGE ACTIVATED" appears on the door entry monitor display for 3 seconds.
 - » The  LED flashes to indicate that the function is active.

Range deactivation:

- ▶ Press and hold buttons  and  together for 5 seconds.
 - » A confirmation tone will play.
 - » The text "CALL RANGE DEACTIVATED" appears on the door entry monitor display for 3 seconds.
 - » The  LED switches off.

Expansion diagrams

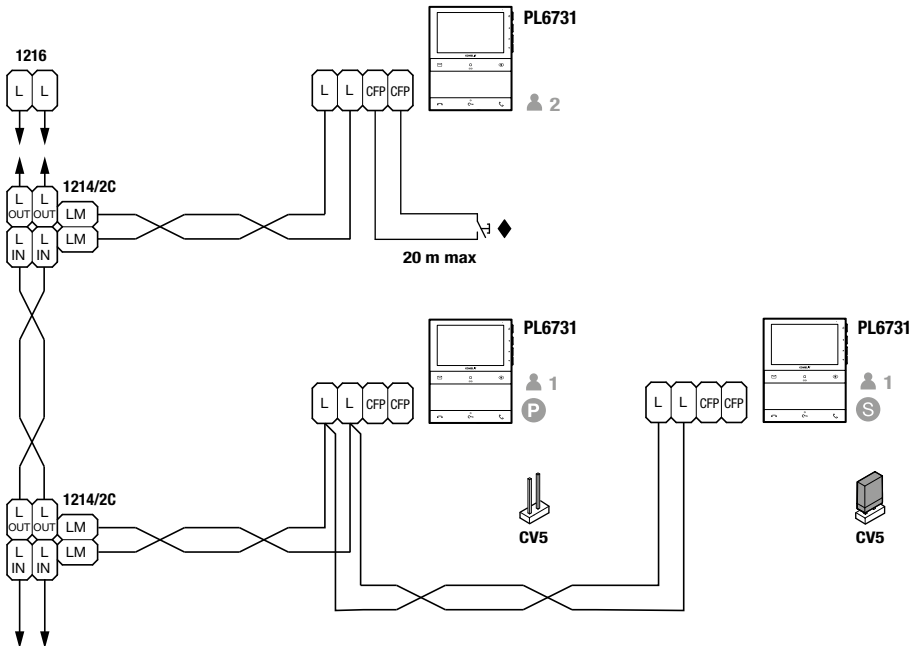

- P S** In systems with power supply unit art. **1210** or **1210A**, a maximum of 1 main door entry monitor (**P**) and 3 secondary door entry monitors (**S**) can be programmed for each apartment.
In systems with power supply unit art. **4888C**, 2 main door entry monitors (**P**) and 2 secondary door entry monitors (**S**) can be programmed for each apartment.

- ◆ CFP floor door call input.**
Where multiple door-entry phones or door entry monitors have the same user code, connect the CFP button on one only; all the devices will ring simultaneously.

Wiring diagrams

System with power supply unit art. 1210/1210A and operating distances

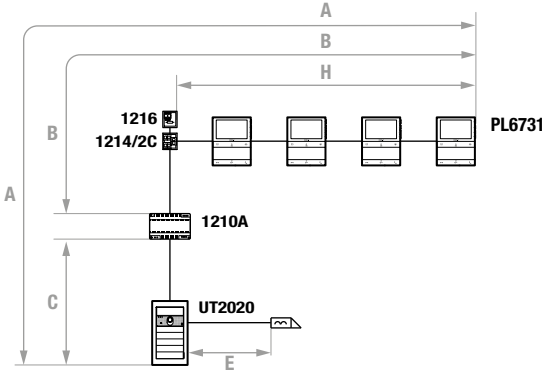

	A MAX	B MAX	C MAX	E MAX	H MAX	Art. 1216
Comelit Art. 4577/4579 1 mm ² (Ø 1.2 mm AWG 17) 	260 m (850 feet)	130 m (425 feet)	130 m (425 feet)		50 m (164 feet)	
UTP5 cat. 5 0.2 mm ² (Ø 0.5 mm AWG 24) 	80 m (260 feet)	40 m (130 feet)	40 m (130 feet)		30 m (98 feet)	
0.28 mm ² (Ø 0.6 mm AWG 23) 	100 m (328 feet)	50 m (164 feet)	50 m (164 feet)		30 m (98 feet)	
0.5 mm ² (Ø 0.8 mm AWG 20) 	140 m (460 feet)	70 m (230 feet)	70 m (230 feet)		30 m (98 feet)	
1 mm ² (Ø 1.2 mm AWG 17) 	200 m (656 feet)	100 m (328 feet)	100 m (328 feet)	30 m (98 feet)	40 m (130 feet)	
1.5 mm ² (Ø 1.4 mm AWG 15) 	80 m (260 feet)	40 m (130 feet)	40 m (130 feet)	50 m (164 feet)	30 m (98 feet)	
UTP cat. 5-6-7 0.2 mm ² (Ø 0.5 mm AWG 24) MULTI PAIR CABLE						
 GREEN GREEN / WHITE ORANGE / WHITE ORANGE BLU BLU / WHITE BROWN / WHITE BROWN	260 m (850 feet)	130 m (425 feet)	130 m (425 feet)		50 m (164 feet)	

UTP cable with multi-cable connection: FOLLOW THE COLOURS SHOWN IN THE DIAGRAM!

BASIC DIAGRAM

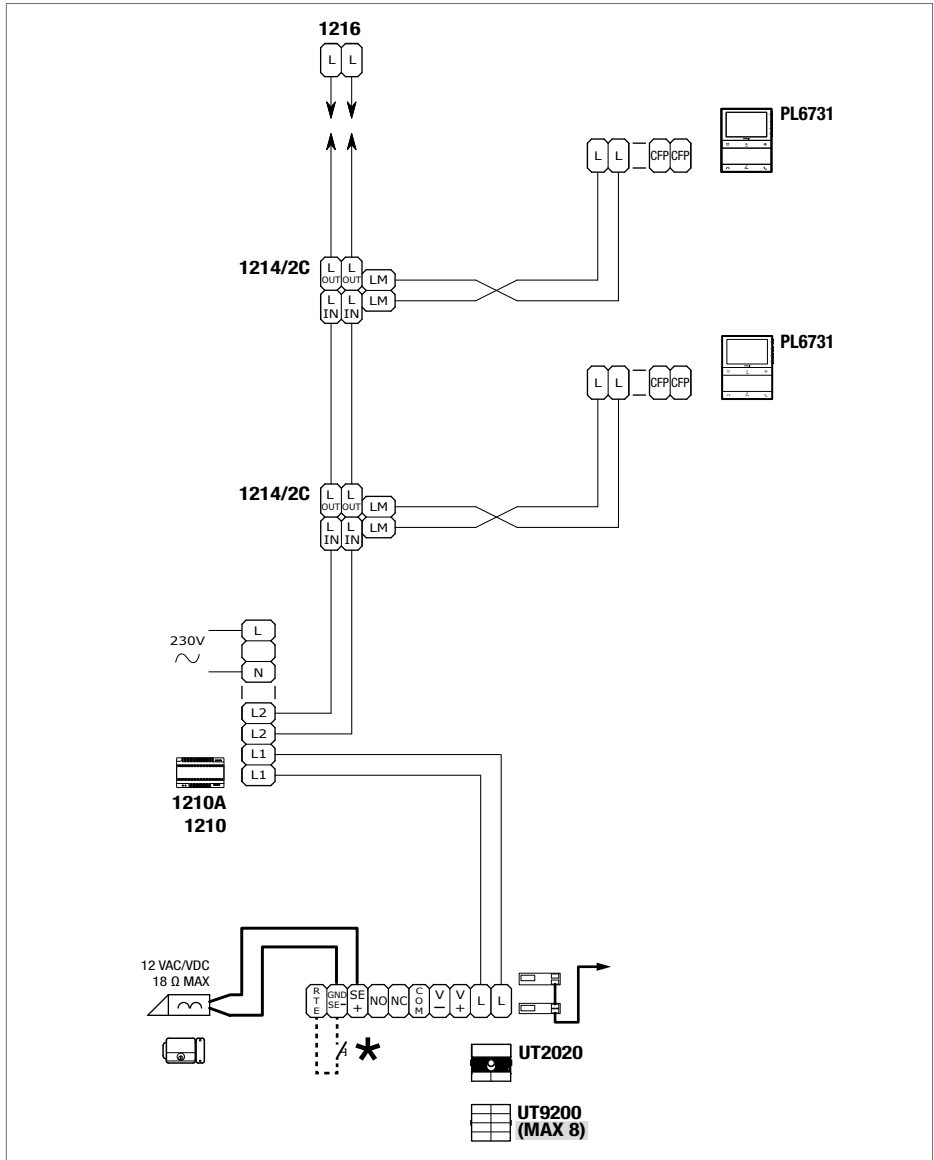

* 20 m max. Local door-opener button.

DIGITAL ENTRANCE PANEL VARIANT WITH TOUCH-SCREEN MODULE ART. UT9270

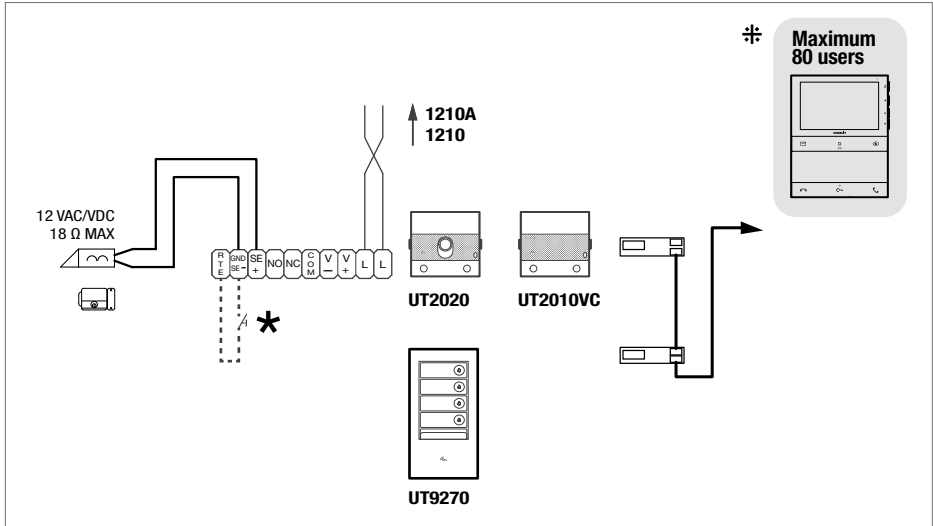

⚡ **Max. 20 m.** Local door-opener button.

⚡ For systems with over 80 users, provide an additional power supply.

VARIANT WITH SEPARATE POWER SUPPLY

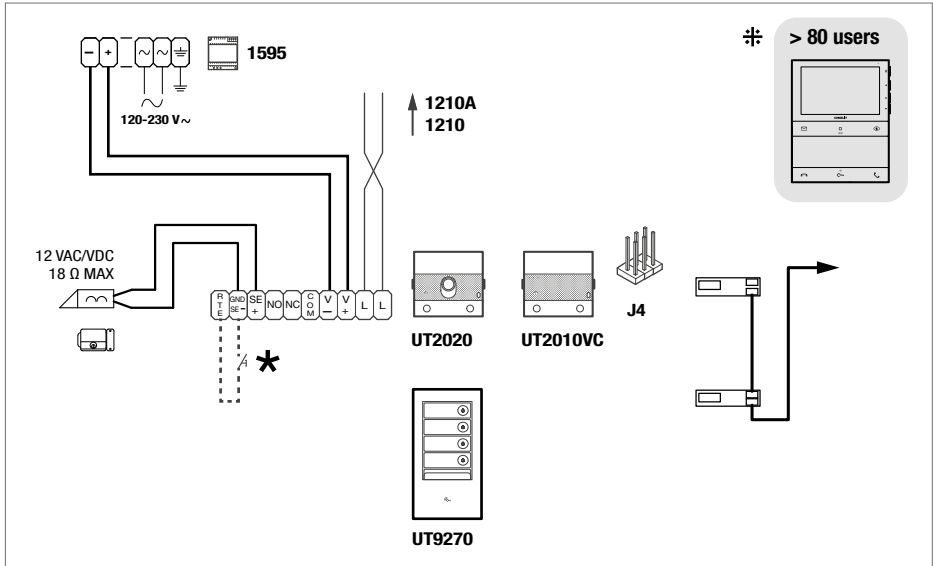







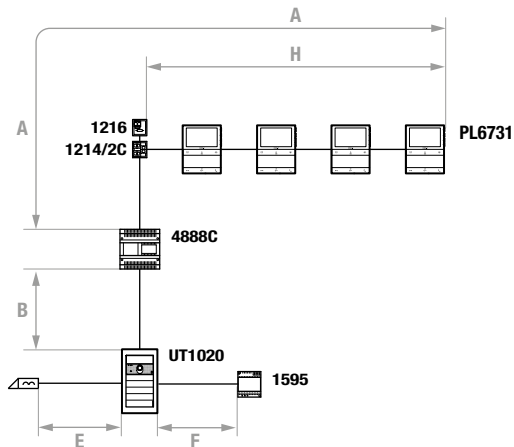







⚡ **Max. 20 m.** Local door-opener button.

⚡ For systems with over 80 users, provide an additional power supply.

System with power supply unit art. 4888C and operating distances



	A MAX	B MAX	E MAX	F MAX	H MAX	Art.1216
Comelit Art. 4577/4579 1 mm ² (Ø 1.2 mm AWG 17) 	200 m (650 feet)	200 m (650 feet)		50 m (165 feet)	100 m (330 feet)	
UTP5 cat. 5 0.2 mm ² (Ø 0.5 mm AWG 24) 	80 m (260 feet)	150 m (490 feet)			60 m (195 feet)	
0.28 mm ² (Ø 0.6 mm AWG 23) 	100 m (330 feet)	150 m (490 feet)		5 m (15 feet)	60 m (195 feet)	
0.5 mm ² (Ø 0.8 mm AWG 20) 	120 m (395 feet)	100 m (330 feet)		25 m (85 feet)	60 m (195 feet)	
1 mm ² (Ø 1.2 mm AWG 17) 	120 m (395 feet)	150 m (490 feet)	30 m (98 feet)	50 m (165 feet)	60 m (195 feet)	
1 mm ² (Ø 1.2 mm AWG 17) 	120 m (395 feet)	80 m (260 feet)		50 m (165 feet)	40 m (130 feet)	
1.5 mm ² (Ø 1.4 mm AWG 15) 	150 m (490 feet)	100 m (330 feet)	50 m (165 feet)	75 m (245 feet)	60 m (195 feet)	
2.5 mm ² (Ø 1.8 mm AWG 13) 	150 m (490 feet)	100 m (330 feet)		100 m (330 feet)	60 m (195 feet)	

BASIC DIAGRAM

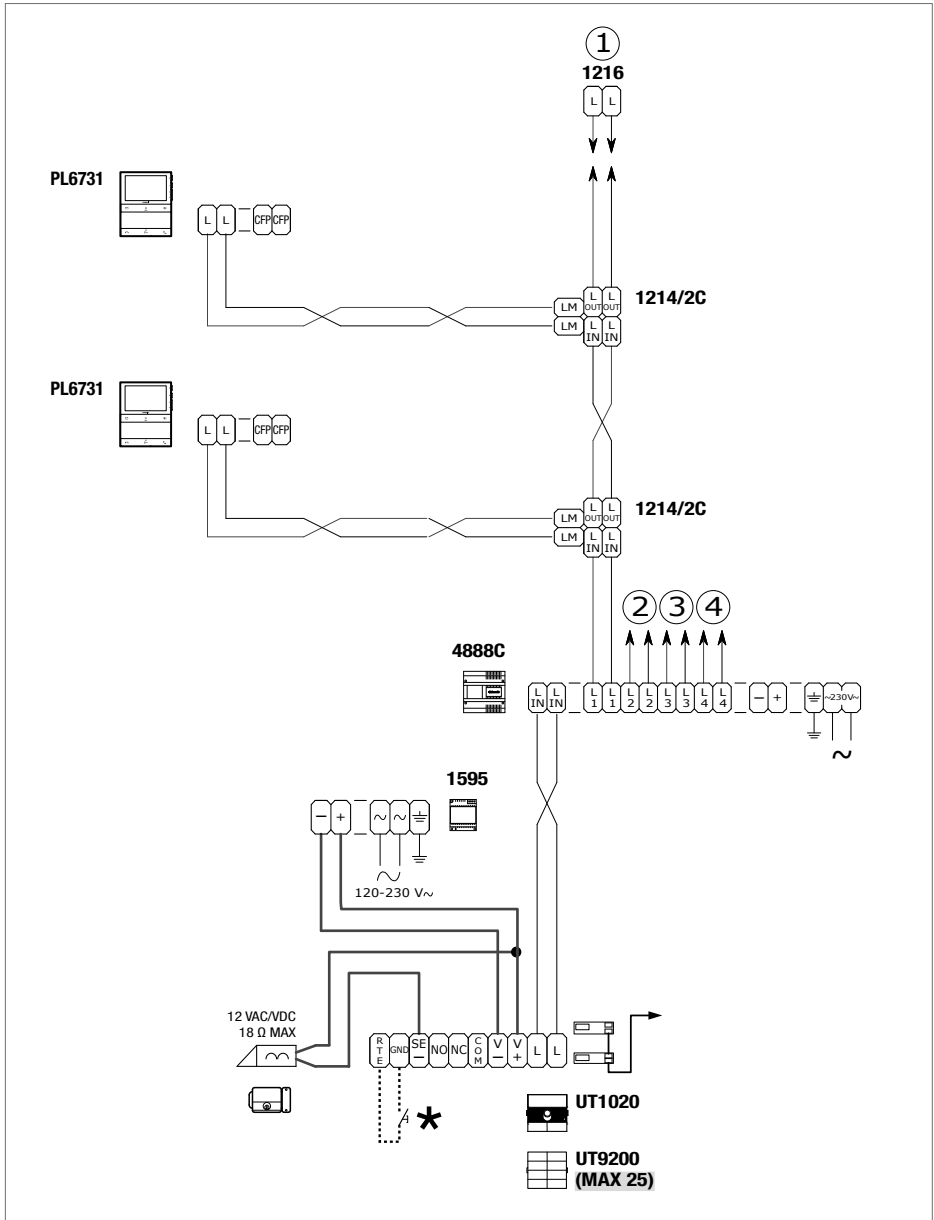

* 20 m max. Local door-opener button.

Warning

Intended use

This Comelit product is designed and manufactured for use in the creation of audio and video communication systems in residential, commercial, industrial and public buildings.

Installation

All activities connected to the installation of Comelit products must be carried out by qualified technical personnel, with careful observation of the indications provided in the Manuals / Instruction sheets supplied with those products. The product must be installed to the highest standards.

Wires

Disconnect the power supply before carrying out any operations on the wiring. Use wires with a cross-section suited to the distances involved, observing the instructions provided in the system manual. We advise against running the system wires through the same duct as power cables (230V or higher).

Safe usage

To ensure Comelit products are used safely:

- carefully observe the indications provided in the Manuals / Instruction sheets,
- make sure the system created using Comelit products has not been tampered with / damaged.

Maintenance

Comelit products do not require maintenance aside from routine cleaning, which should be carried out in accordance with the indications provided in the Manuals / Instruction sheets.

Any repairs must be carried out:

- for the products themselves, exclusively by **Comelit Group S.p.A.**,
- for the systems, by qualified technical personnel.

Do not use alcohol or aggressive products for cleaning purposes.

Disclaimer

Comelit Group S.p.A. does not assume any responsibility for

- any purpose other than the intended use,
- failure to observe the indications and warnings contained in this Manual / Instruction sheet.

Comelit Group S.p.A. reserves the right to change the information provided in this Manual / Instruction Sheet at any time and without prior notice.

Directives



The manufacturer, **Comelit Group S.p.A.**, hereby declares that this equipment conforms to the applicable directives. The full EU conformity declaration is available on the product web page.



In accordance with art. 26 of Italian Legislative Decree dated 14th March 2014, no. 49 "Implementation of directive 2012/19/EU on Waste Electrical and Electronic Equipment (WEEE)", the "crossed-out wheellie bin" symbol indicates that at the end of its useful life, this product must be separated from other waste before collection for disposal. The user should therefore take the exhausted appliance to suitable local collection centres for waste electrical and electronic products. As an alternative to handling this process yourself, you can take the appliance to your local equipment dealer when purchasing a new equivalent product. Electronics dealership businesses covering an area of 400 m² are also obliged to accept waste electronic products smaller than 25 cm for disposal, without any obligation to purchase. Suitable separated waste collection for the subsequent reuse of the appliance sent for recycling, processing and environmentally conscious disposal helps to avoid potential negative effects on the environment and human health, and encourages the reuse and recycling of the materials used in the construction of the appliance.



CERTIFIED MANAGEMENT SYSTEMS



www.comelitgroup.com

Via Don Arrigoni, 5 - 24020 Rovetta (BG) - Italy

1st edition 01/2024
code 2G40003139