

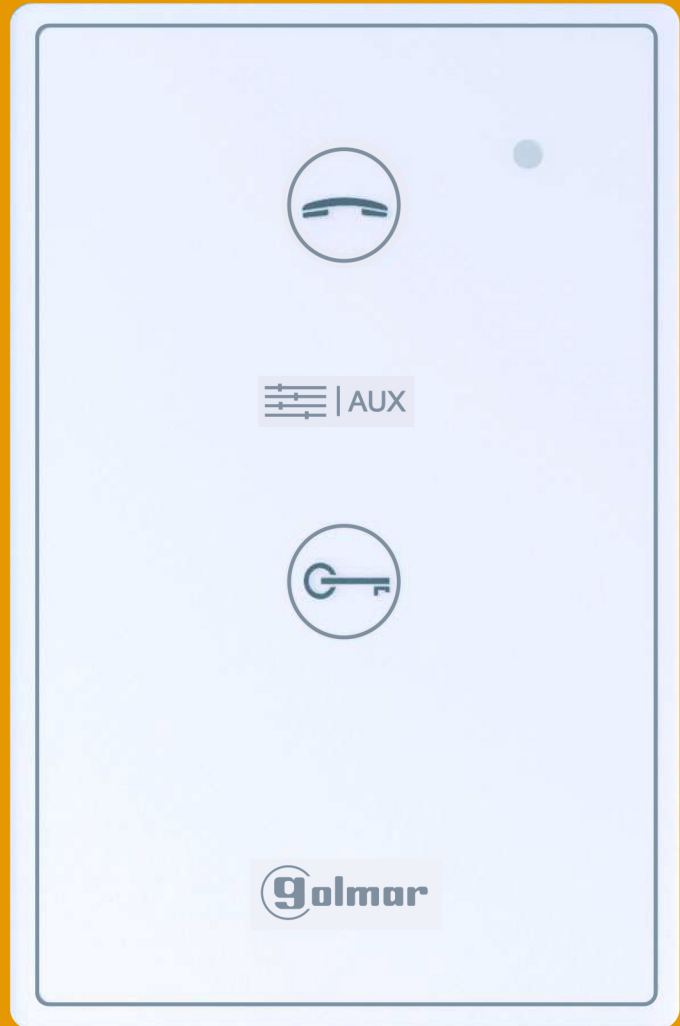

NHEA GB2

USER MANUAL



INTRODUCTION

First and foremost we would like to thank you for purchasing this product.

Our commitment to satisfying our customers can be seen from our ISO-9001 certification and from the manufacturing of products like this one.

Its advanced technology and exacting quality control will ensure that customers and users enjoy the many features this system offers. To obtain the maximum benefit from these features and a properly wired installation, we kindly recommend that you spend a few minutes of your time reading this manual.



CONTENTS

Introduction.....	2
Contents.....	2
Safety precautions.....	2
Characteristics.....	3
System operation.....	3
Description of the Nhea terminal.....	
Description.....	4
Function push buttons.....	4
Status LED.....	4
Connection terminals.....	4
Audio volume control.....	4
Call volume control.....	4
Configuration dip switch.....	5
Setting the terminal's address codes.....	5-6
Front LED functions.....	6
Setting the ringtones.....	7
Intercom function.....	7
“Do not disturb” mode function.....	7
Activation light function (stairs light).....	7
Terminal installation.....	
In surface box.....	8
In embedding box.....	9
Wiring diagrams.....	10
Notes.....	11









SAFETY PRECAUTIONS

- **Always disconnect the power supply** before making modifications to the equipment.
- The installation and handling of these devices must be carried out by **authorised personnel**.
- The wiring must run at least **40cm away from any other wiring**.
- Do not overtighten the screws on the terminal block.
- Install the Nhea terminal in a dry and protected place without risk of drip or water projections.
- Do not place in humid, dusty or smoky locations, or near sources of heat.
- Before connecting the device to the mains, check the connections between the door panel, power supply and Nhea terminals.
- Always follow the instructions contained in this manual.

CHARACTERISTICS

- Nhea hands-free audio terminal with simplified installation (non-polarised 2 wire bus).
- Up to 4 Nhea terminals/monitors per apartment (master, slave 1, slave 2 and slave 3).
- Up to 32 apartments/Nhea terminals per installation.
- Completely private conversation.
- Call volume control (maximum and minimum).
- Audio volume control (maximum and minimum).
- Input for external door bell push button.
- Different ringtones to identify the origin of the call (door panel, intercom or apartment door).
- Start/stop communication and intercom call (within the same apartment) push button .
- Lock release 1 activation push button .
- Lock release 2/“Do not disturb” mode activation/ activation light (it requires of SAR-GB2 & SAR-12/24 modules) push button **AUX**.
- Ringtone settings push button .
- Dip switches for setting the terminal's address (call code), master/slave and end of line.

SYSTEM OPERATION

- To make a call, the visitor must press the button of the apartment; an audible sound indicates that the call is being made and the door panel LED  will turn on. If vocal synthesis is activated then a “Call is in progress” message will indicate a call is being made. At this moment, the apartment's terminal(s) receives the call. During the call the visitor can correct his call by pressing a push button corresponding to a different apartment, in which case the original call is cancelled.
- The call lasts for 40 seconds. If the call is not answered within 40 seconds, LED  will turn off and the channel will be freed.
- To establish communication, press push button  on any terminal in the apartment. Door panel LED  will turn on. If the vocal synthesis is activated the message “you can speak now” will be heard confirming the communication is activated.
- Communication will last for one and a half minutes or until push button  is pressed again. When communication has finished, LEDs  and  will turn off and the channel will be freed. If vocal synthesis is activated then a “Communication is finished” message will indicate that the call is over on the door panel.
- To open the door, press push button  (if it exists, to open the second door, press push button **AUX**) during the call or communication processes: one press activates the lock release for five seconds and the door panel LED  will also turn on for five seconds. If vocal synthesis is activated, a “Door is open” message will be indicated on the door panel.
- The descriptions of the function push buttons are found on page 4.

TERMINAL DESCRIPTION:

Description:

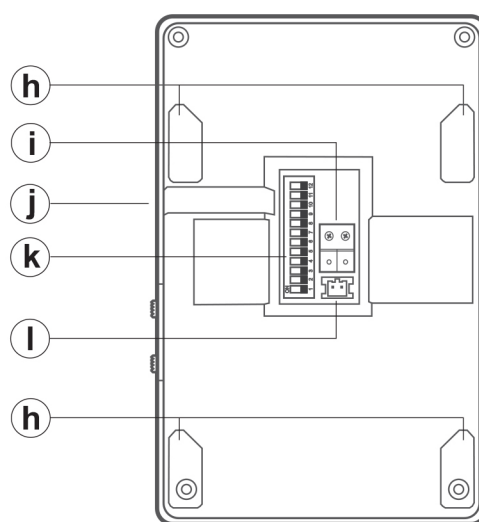
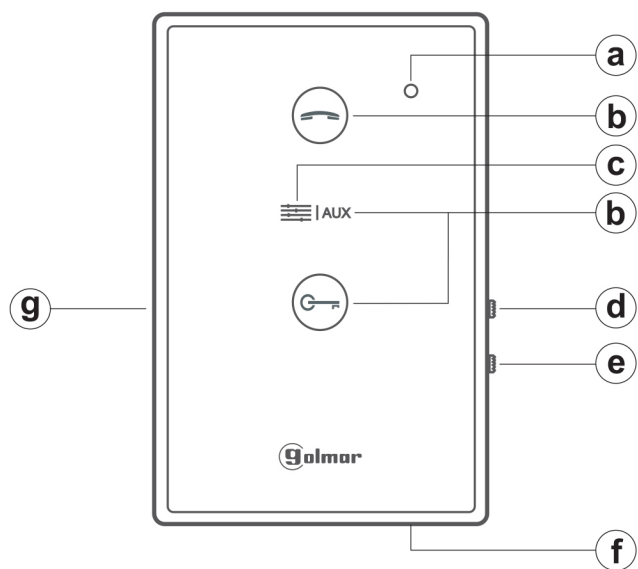

- a. Status LED.
- b. Function push buttons.
- c. Ringtone settings push button.
- d. Audio volume control switch.
- e. Ringtone volume control switch.
- f. Microphone.
- g. Speaker.

- h. Attachment holes.
- i. BUS connection terminals.
- j. Horizontal cable input.
- k. Configuration DIP switch.
- l. "Hz" connector.

Function push buttons:

 Start/stop communication push button. During standby: Press for 3 seconds to make an intercom call (same apartment).

 Activates lock release 1 during the call reception and communication processes.

AUX Activates lock release 2 during the call reception and communication processes. During standby: One rapid press activate light. (It requires of SAR-GB2 & SAR-12/24 modules). Press for 3 seconds to activate / deactivate "do not disturb" mode.

 Ringtone settings push button. During standby: Press for 3 seconds to enable the ringtones to be set.

Status LED:

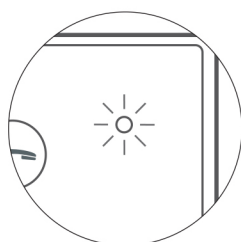

LED off:
Terminal without power.
LED on:
Terminal with power.
Intermittent LED:
Terminal in "do not disturb" mode.

Description of connection terminals:

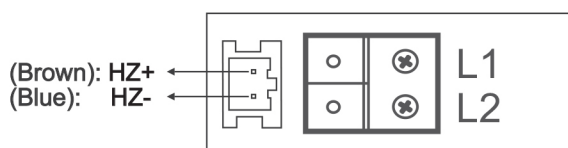

L1, L2: BUS Connection.
HZ+, HZ-: Door bell push button connection.

Audio volume control:



The terminal has a communication audio volume control with maximum and minimum volume settings.

Call volume control:

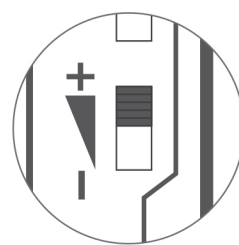

The terminal has a call volume control with maximum and minimum volume settings.

TERMINAL DESCRIPTION:

Description of the dip switch and setting the audio terminal address (code):

Dip1 to Dip5: Set the audio terminal address (addresses 0 to 31).

Dip6 and Dip7: Leave OFF.

Switches set to OFF have a value of zero.

The values of the switches set to ON are shown in the enclosed chart.

The audio terminal code is the sum of the values of the switches set to ON.

Value chart

Switch number:	1	2	3	4	5
ON value:	1	2	4	8	16

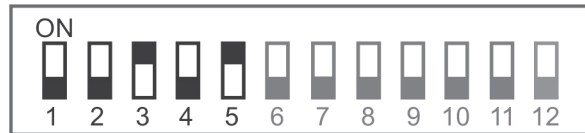

Example: $0 + 0 + 4 + 0 + 16 = 20$

Dip8 and Dip9: Set the terminal as master/slave. Dip8 and Dip9 OFF, master; Dip8 ON and Dip9 OFF, slave 1; Dip8 OFF and Dip9 ON, slave 2; Dip8 and Dip9 ON, slave 3.

Dip10: Leave OFF.

Dip11: Sets the end of line. It should always be set to OFF in installations with only audio terminals. In mixed installations with monitors and audio terminals in the same apartment, set to ON for the audio terminals in which the BUS cable ends and set to OFF for intermediate audio terminals.

Dip12: Leave in the OFF position (not functioning).

Setting the audio terminal's address codes (addresses 0 to 31):

Dip11: Sets the end of line. It should always be set to OFF in installations with only audio terminals. In mixed installations with monitors and audio terminals in the same apartment, set to ON for the audio terminals in which the BUS cable ends and set to OFF for intermediate audio terminals.

Dip11 to OFF



Dip11 to ON



Dip1 to Dip5: To set the audio terminal address (addresses 0 to 31).

Code 00



Code 01



Code 02



Code 03



Code 04



Code 05



Code 06

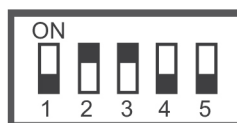

Code 07

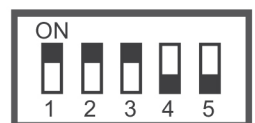

Code 08



Code 09



Code 10



Code 11



TERMINAL DESCRIPTION:

Continued from previous page.

Code 12



Code 13



Code 14



Code 15



Code 16

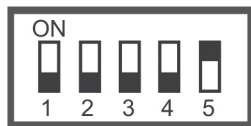

Code 17

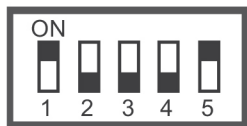

Code 18



Code 19



Code 20



Code 21



Code 22



Code 23



Code 24

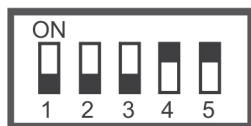

Code 25

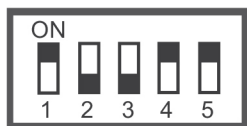

Code 26



Code 27



Code 28



Code 29





Code 30





Code 31



Description of front LED functions:

The Nhea GB2 terminal has a status LED and LEDs on function push buttons  and  to indicate the status of the terminal.

	LED 	LED 	STATUS LED
Standby (no power)	OFF	OFF	OFF
Standby (with power)	OFF	OFF	ON
“Do not disturb” mode activated	OFF	OFF	Blinking
Call from door panel (ringtone in terminal)	Rapid blink	ON	ON
Communication with door panel	Slow blink	ON	ON
Call from terminal (ringtone in terminal)	Rapid blink	ON	ON
Communication with terminal	Slow blink	ON	ON
Ringtone settings mode	Slow blink	Slow blink	ON Blinking
Call from apartment door (ringtone in terminal)	OFF	OFF	ON

TERMINAL DESCRIPTION:

Setting the ringtones:



Description:

To change the terminal's ringtones (door panel, intercom and apartment door), press settings push button .



There are three tone groups and each group comprises three set tones. The first tone of each group that is heard during selection, corresponds to door panel calls, the second tone to intercom calls and the third tone to apartment door calls.

Setting and selecting the ringtone group:

The terminal must be in standby to set and select the ringtone group.

To change the ringtones, press push button  for 3 seconds. The LEDs on buttons  and  will blink to indicate that the terminal is in settings mode.

To change the ringtone group, press settings button  until the required ringtone group can be heard (up to 3 ringtone groups available in carousel mode).



To exit and save the selected ringtone group, press push button  and the LEDs on push buttons  and  will turn off. The terminal exits settings mode after 7 seconds of inactivity and saves the last ringtone group selected.

Make a call to check that the correct ringtone group has been selected.

Intercom function:

Intercom functionality between two points in the same apartment comes as standard with the Nhea GB2 terminal.

The terminal must be in standby to make intercom calls.

To make an intercom call, press push button  for 3 seconds. The LED on push button  will blink, the LED on push button  will light up and the terminal(s) being called in the apartment will ring to confirm that the call is being made.

There is a period of 40 seconds to attend to the call.

To establish communication, press push button  on the terminal called (or one of the terminals called if there is more than one slave terminal).

Communication will last for one and a half minutes or until push button  is pressed again.

“Do not disturb” mode function:

The terminal must be in standby to activate/deactivate “Do not disturb” mode.

To activate “Do not disturb” mode, press push button **AUX** for 3 seconds. The terminal's status LED will then blink to indicate that the function is activated. The terminal will not receive door panel, intercom or apartment door calls.

More than one terminal in the same apartment: Master terminal with "Do not disturb" mode activated, will not receive door panel calls on the apartment. If "Do not disturb" mode is activated on slave terminal (instead of master terminal), the apartment will receive door panel calls but not the slave monitor with “Do not disturb” mode activated.

To deactivate “Do not disturb” mode, press push button **AUX** for 3 seconds. The terminal's status LED will then light up to indicate that the function is deactivated. The terminal will now receive door panel, intercom and apartment door calls.

Activation light function:

The terminal must be in standby to activate the light (it requires of SAR-GB2 and SAR-12/24 modules).

To activate light function (for example "stairs light"), one rapid press on push button **AUX**.

Important: For the wire and configuration, see TSAR-GB2 and TSAR-12/24 manuals.

INSTALLATION OF THE TERMINAL IN A SURFACE BOX

Avoid dusty or smoky environments or locations near sources of heat.

Positioning the surface box:

The upper part of the surface box must be placed at a height of 1.60m. The minimum distance between the sides of the surface box and the closest object must be 5cm.

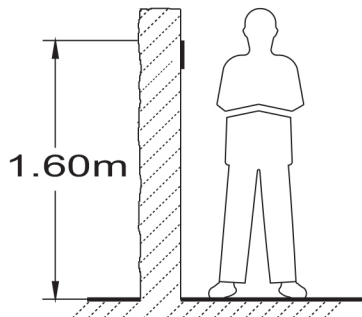

Fixing the terminal's surface box to the wall:

Fix the terminal's surface box to the wall by drilling two 6mm diameter holes and using the screws and plugs supplied with the terminal.

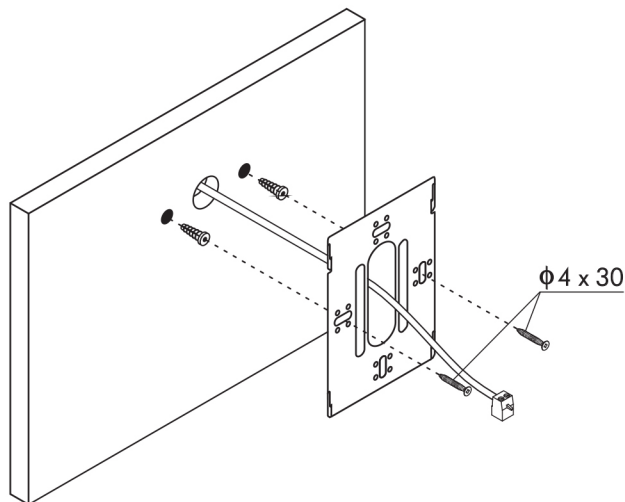

Positioning the terminal:

Connect the cables to the terminal (see page 4), position the terminal frontwards onto the surface box ensuring that the holes in the base of the terminal line up with those on the surface box ① and then move the terminal downwards ② until the terminal is fixed to the surface box ③.

Remember to remove the protective covering from the front of the terminal once installation has been completed.

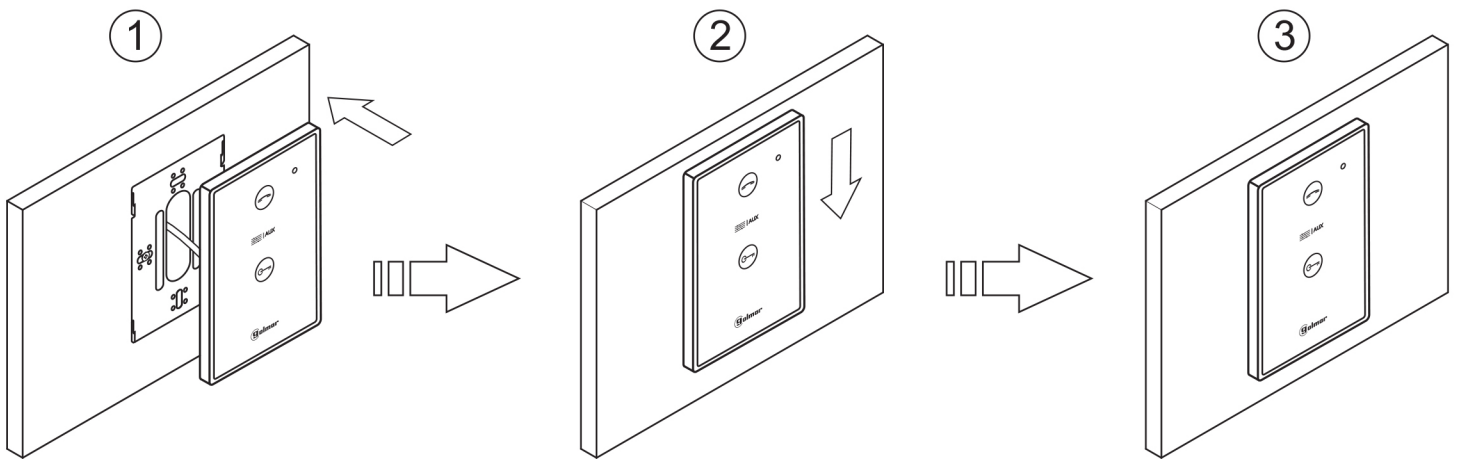

INSTALLATION OF THE TERMINAL IN AN EMBEDDING BOX

Avoid dusty or smoky environments or locations near sources of heat.

Positioning the embedding box:

Make a hole in the wall to position the top of the universal embedding box at a height of 1.60m from the ground. The minimum distance between the embedding box and the closest object must be 5 cm.

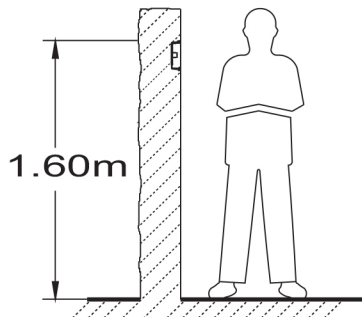

Positioning the embedding box and mounting the connection block:

Pass the cable through the hole made in the embedding box. Embed the box and ensure that it is level and flush. Fix the terminal's connection block with the screws supplied with the embedding box.

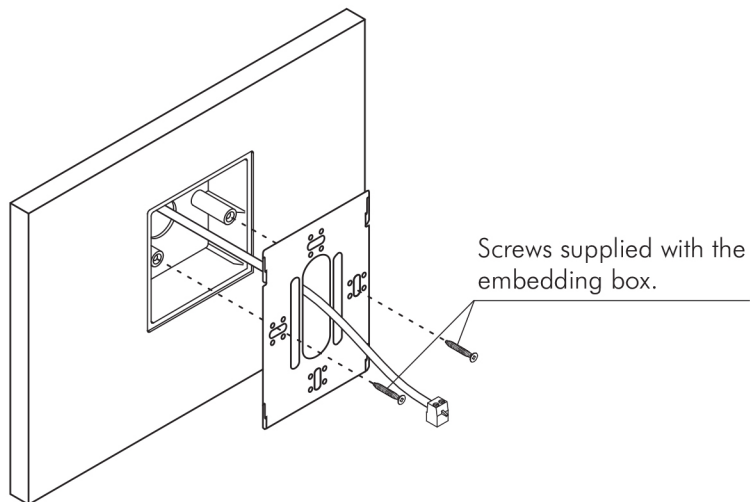

Positioning the terminal:

Connect the cables to the terminal (see page 4), position the terminal frontwards onto the surface box ensuring that the holes in the base of the terminal line up with those on the surface box ① and then move the terminal downwards ② until the terminal is fixed to the surface box ③.

Remember to remove the protective covering from the front of the terminal once installation has been completed.

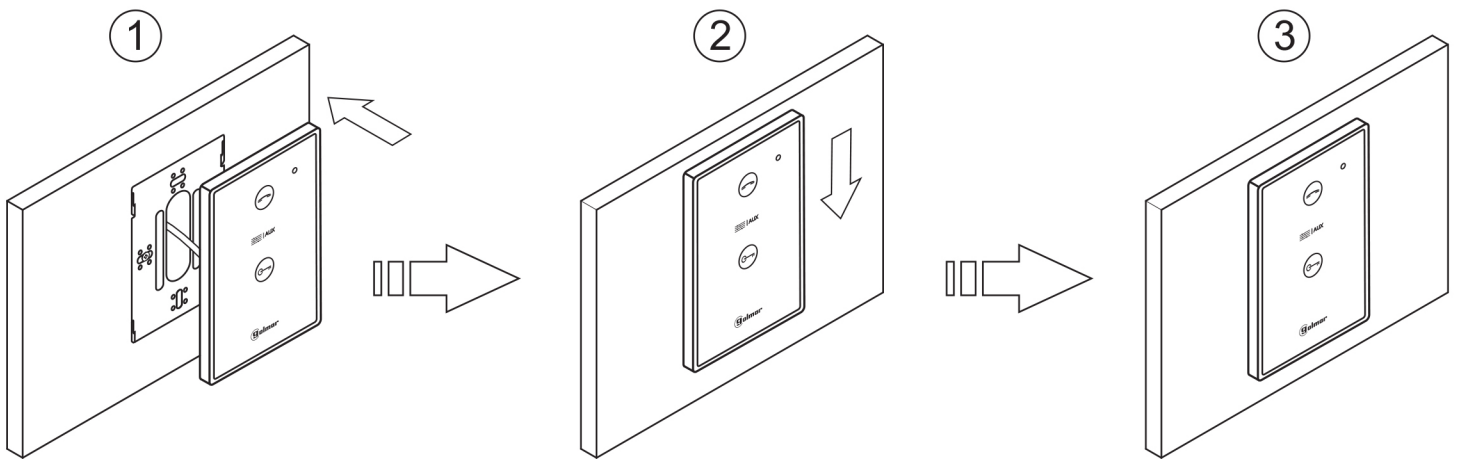

WIRING DIAGRAMS

Installation with 32 apartments/NHEA GB2 terminals and Golmar DC lock release:

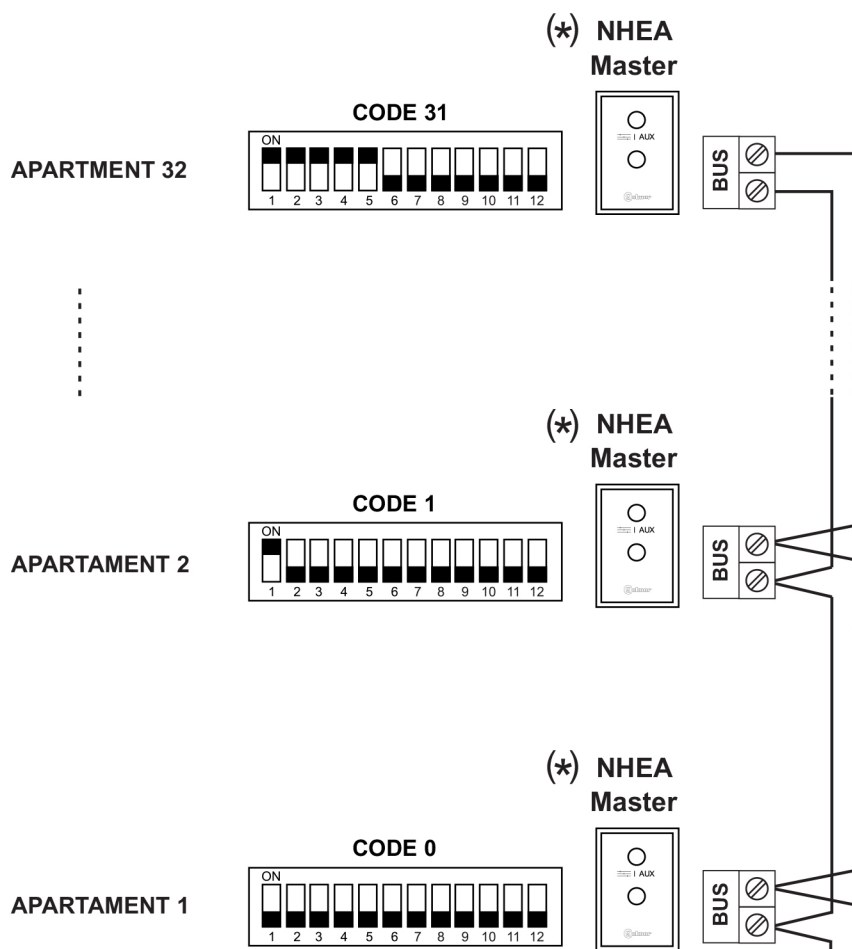

Distances and sections:

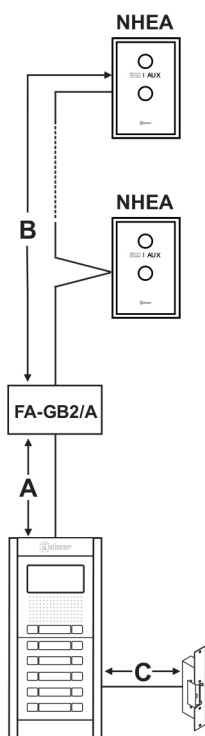

Cable	A	B	C
Twisted pair 2x0.75 mm ²	60m	60m	10m
Twisted pair 2x1 mm ²	80m	80m	15m

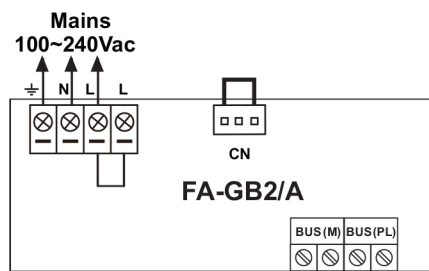

Access door panel

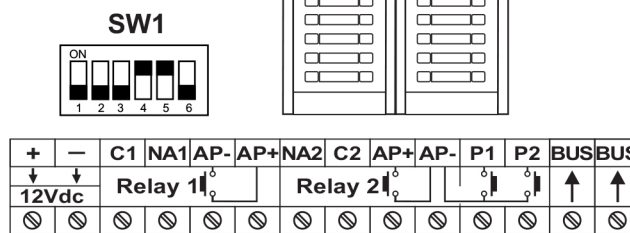

Lock release (*) max 12Vdc/270mA.

(*) For further information about the door panel, AC lock release connection, a second lock release or mixed installations with monitors and audio terminals, Please view full door panel manual: http://wiring.alphacomunications.com/NEXA_GB2_MANUAL.PDF

