



## Gateway Fiber



1x

**a**

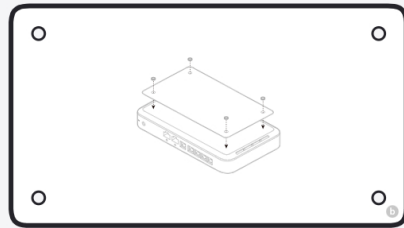

1x

**b**

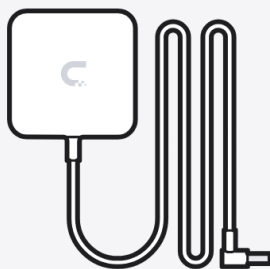

1x

**c**



1x

**d**



2x

**e**

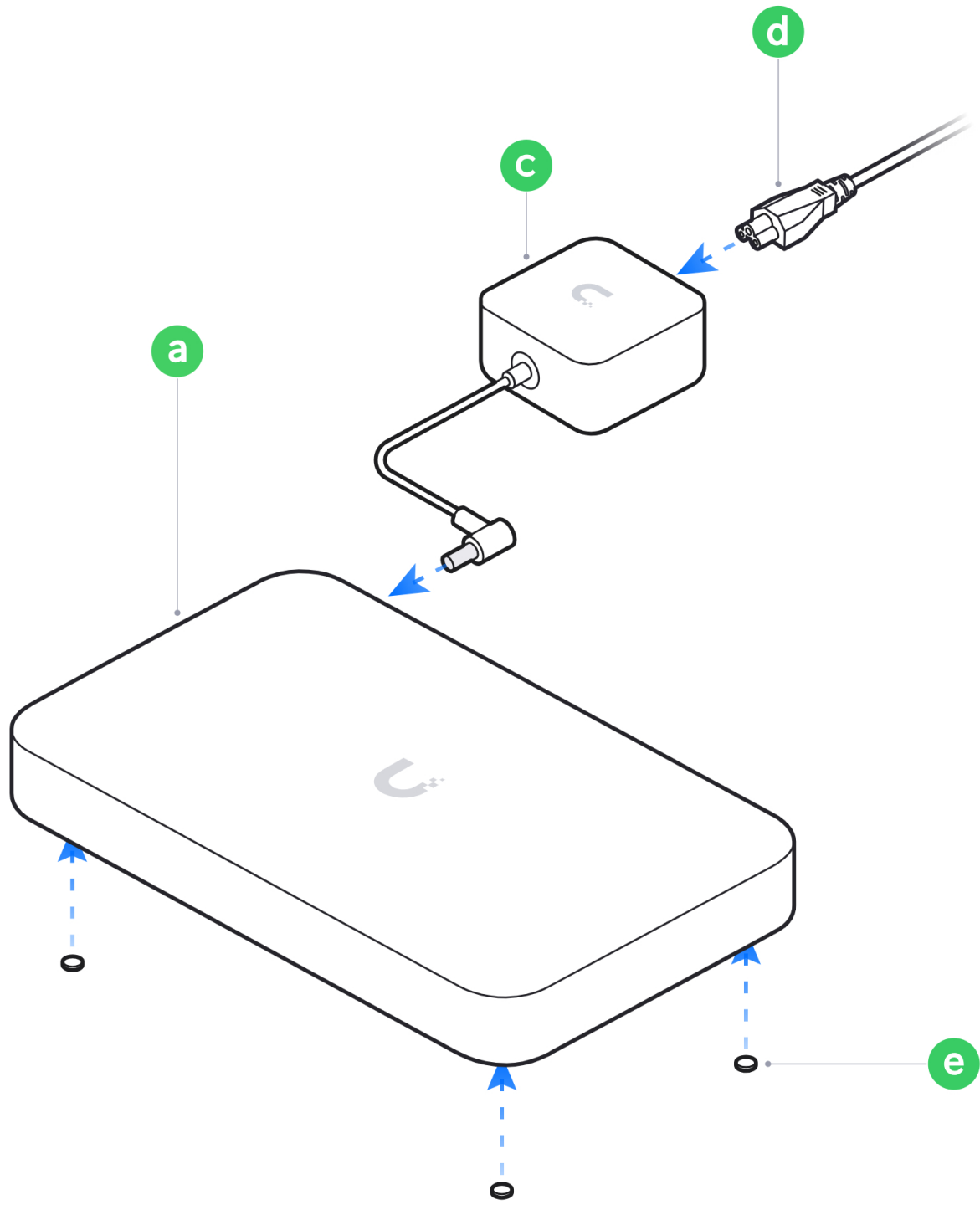

1



1x

**a**

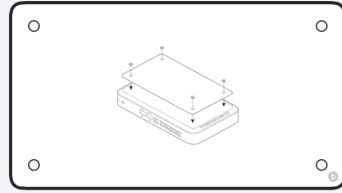

1x

**b**

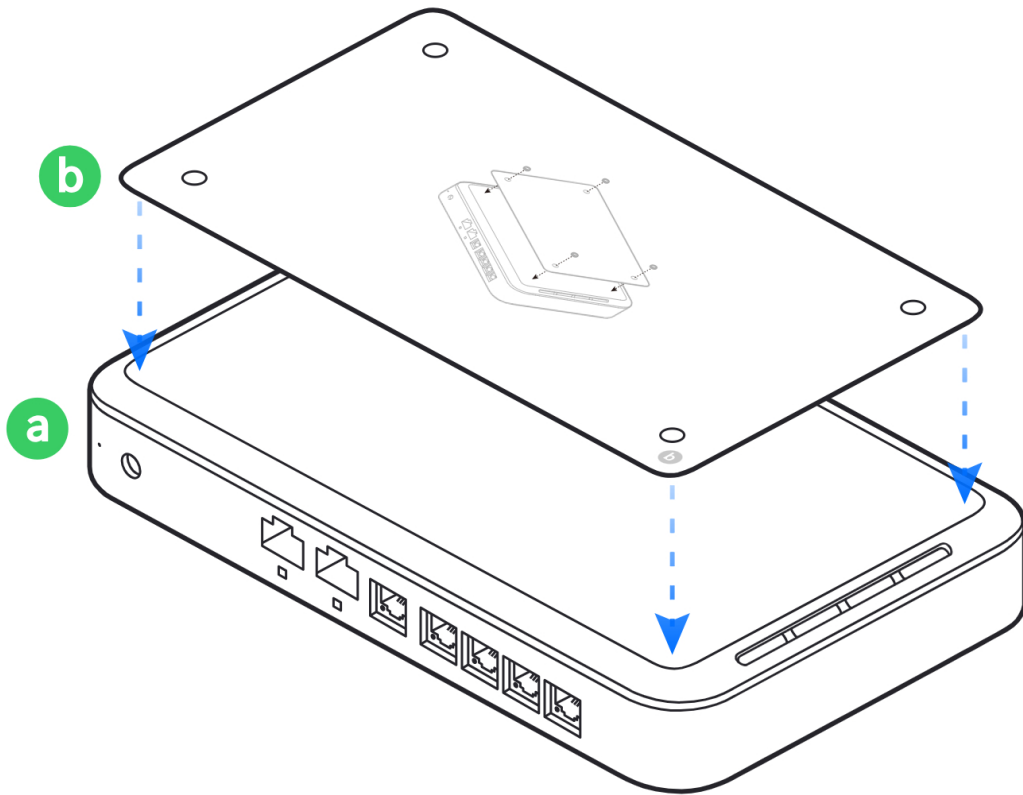

# 2



1x

**e**

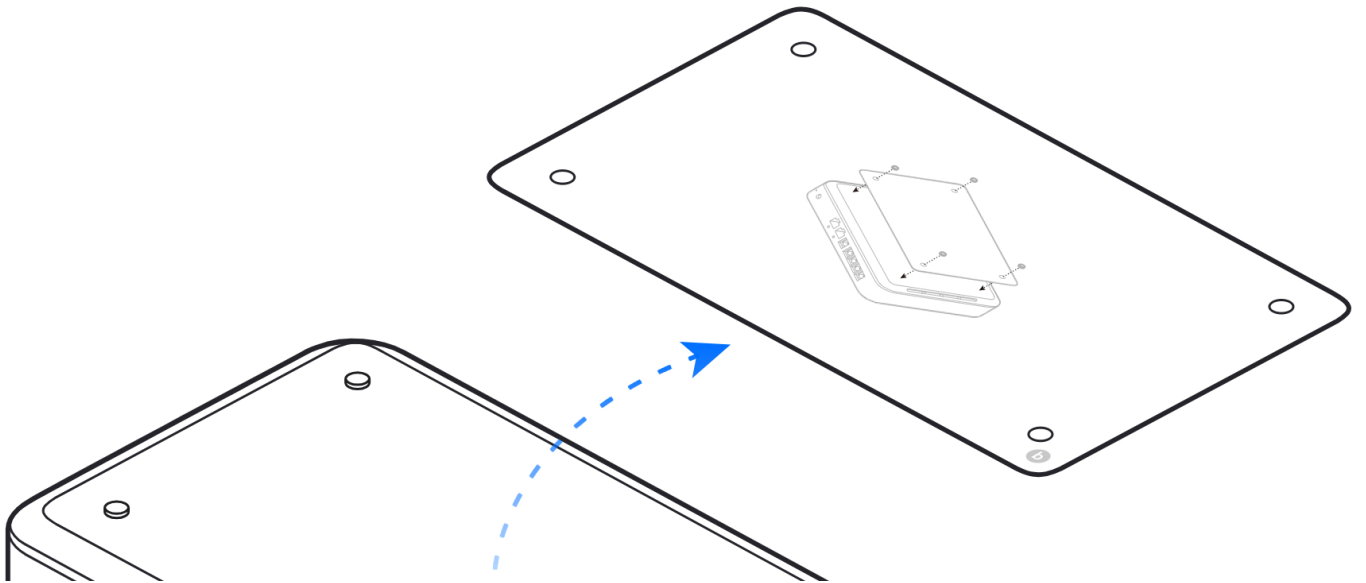
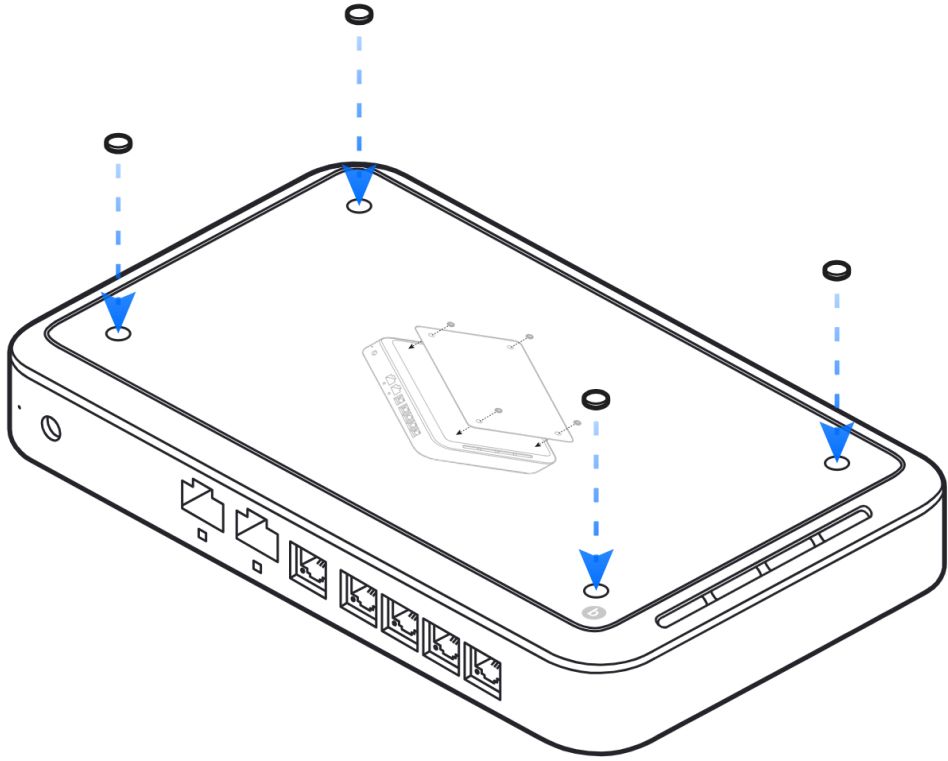
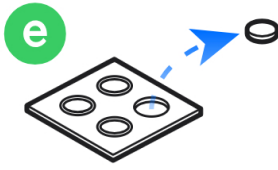

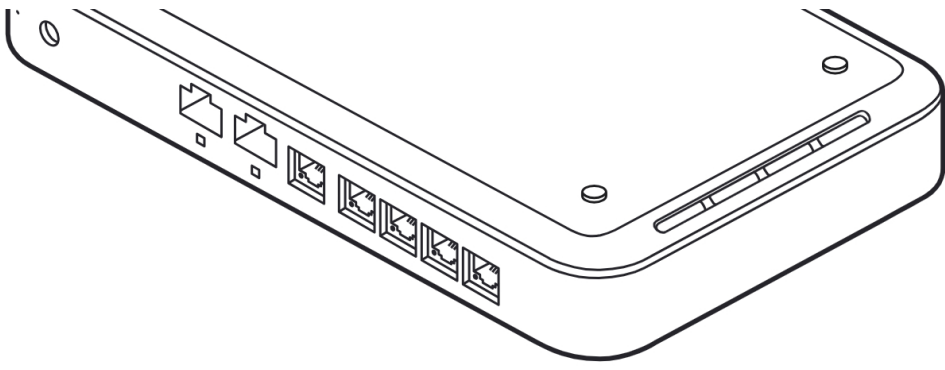

# 3

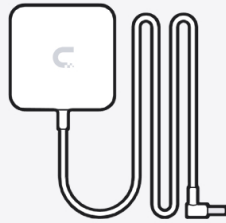

1x

c



1x

d

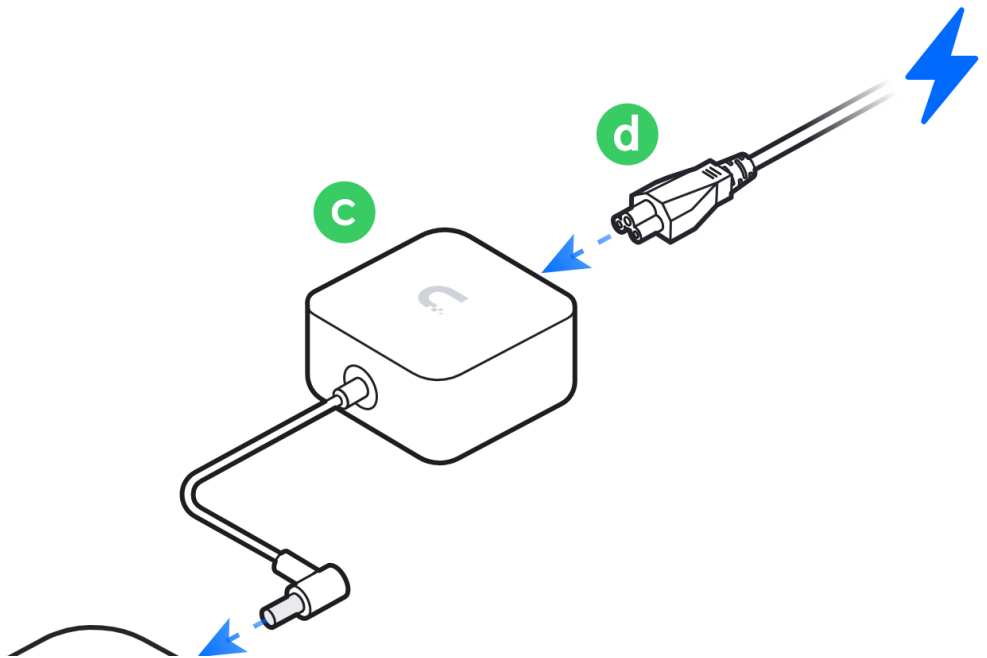

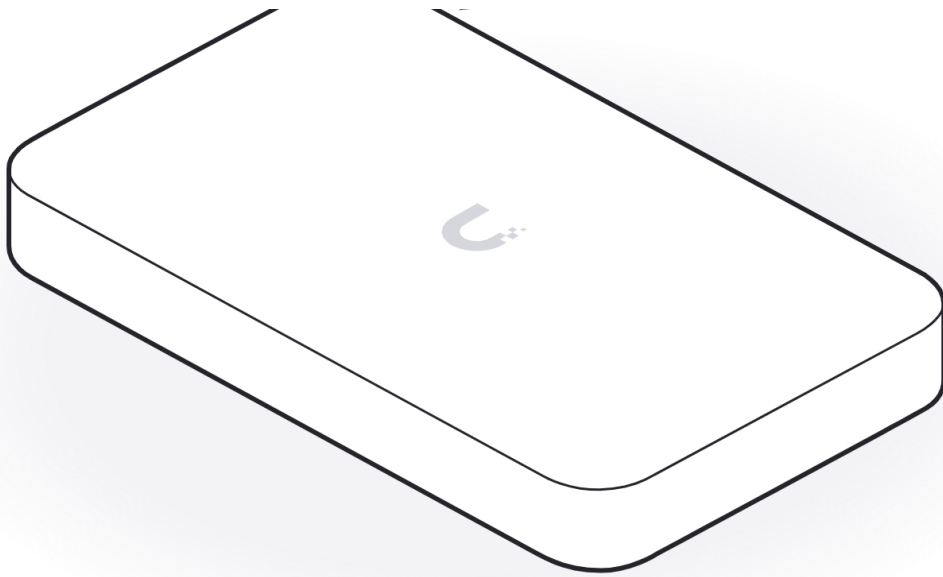

**4**

**A**



**Official  
UniFi Hosting**



**B**



**Official  
UniFi Hosting**





Internet



10G

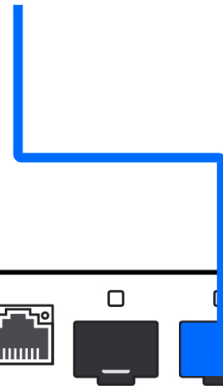

Internet



10G

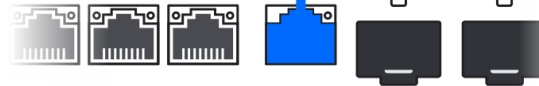

C



D





Internet



10G

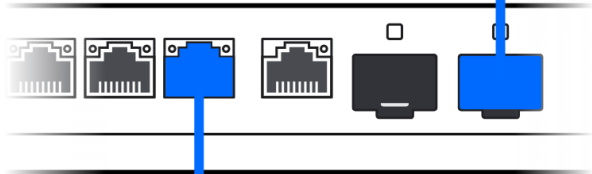
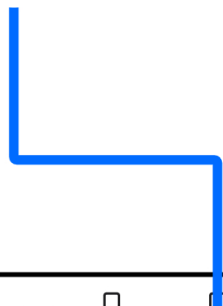

PoE



CloudKey



Internet



10G

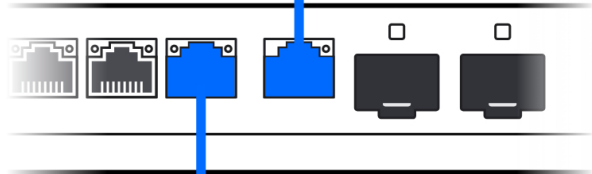

PoE



CloudKey

CloudKey

CloudKey

5



6

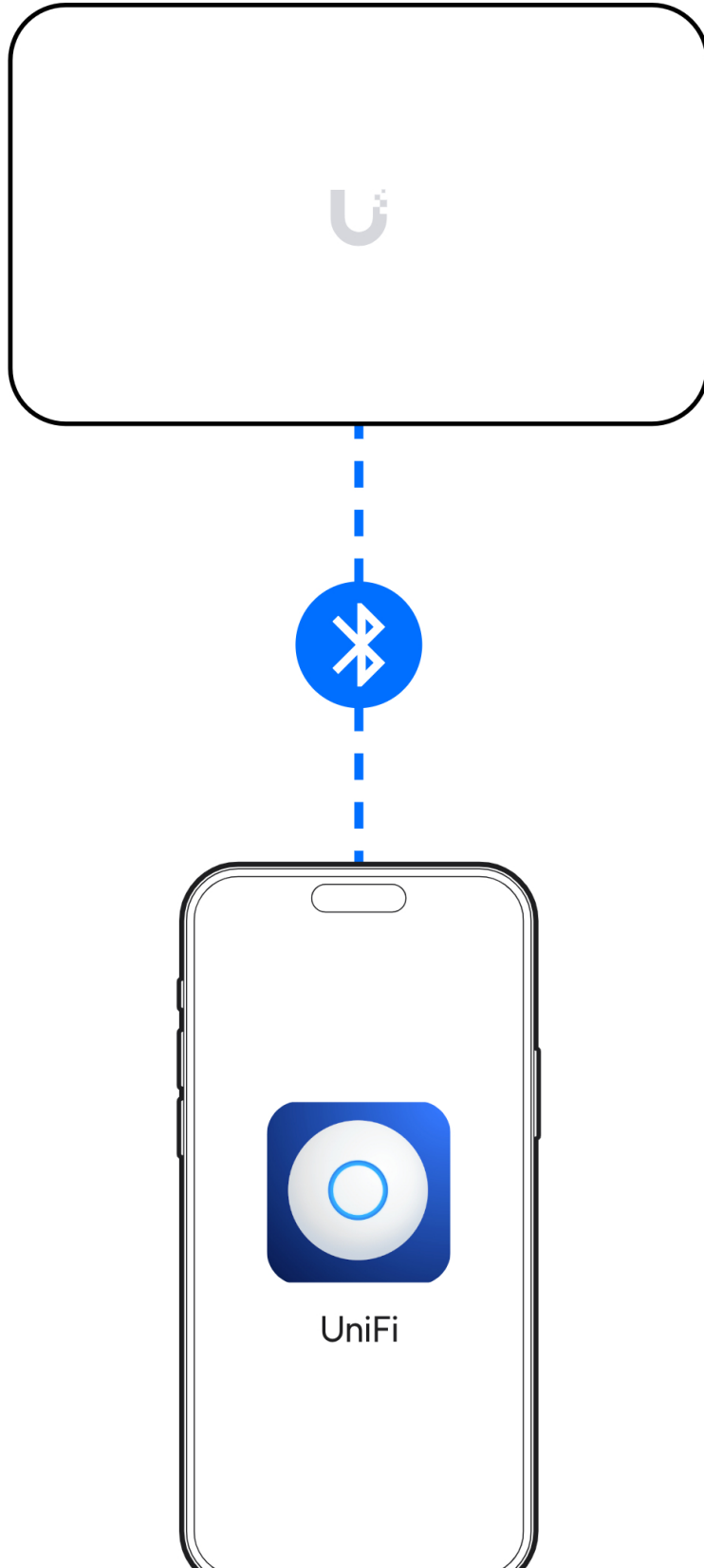



If you need further assistance, visit our [Help Center](#) or contact [Ubiquiti Support](#).

©2024 Ubiquiti Inc. All rights reserved. Ubiquiti, the Ubiquiti U logo, and UniFi are trademarks or registered trademarks of Ubiquiti Inc. in the United States and in other countries. Apple and the Apple logo are trademarks of Apple Inc., registered in the U.S. and other countries. App Store is a service mark of Apple Inc., registered in the U.S. and other countries. Android, Google, Google Play, and the Google Play logo are trademarks of Google LLC.