

ITEM NO.	DESCRIPTION	QTY.
1	PLATE, FURNITURE, 2-PORT, W/LABELS	1
2	CARD, PAPER, 40X1.92, BLANK	1
3	COVER LABEL, CLEAR	1

CATALOG NUMBER	COLOR	DESCRIPTION
FP2GY	GREY	PLATE, FURNITURE 2 PORT
FP2BK	BLACK	PLATE, FURNITURE 2 PORT
FP2OW	OFFICE WHITE	PLATE, FURNITURE 2 PORT
FP2W	WHITE	PLATE, FURNITURE 2 PORT
FP2BN	BROWN	PLATE, FURNITURE 2 PORT

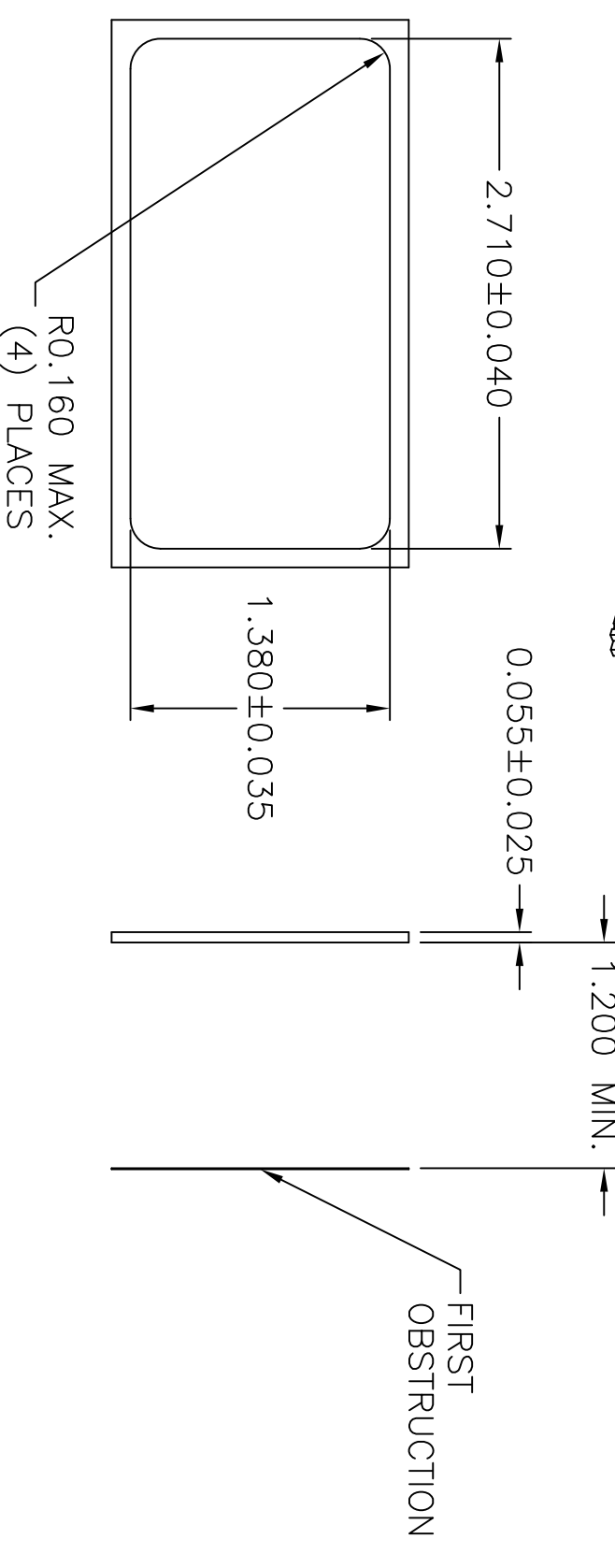
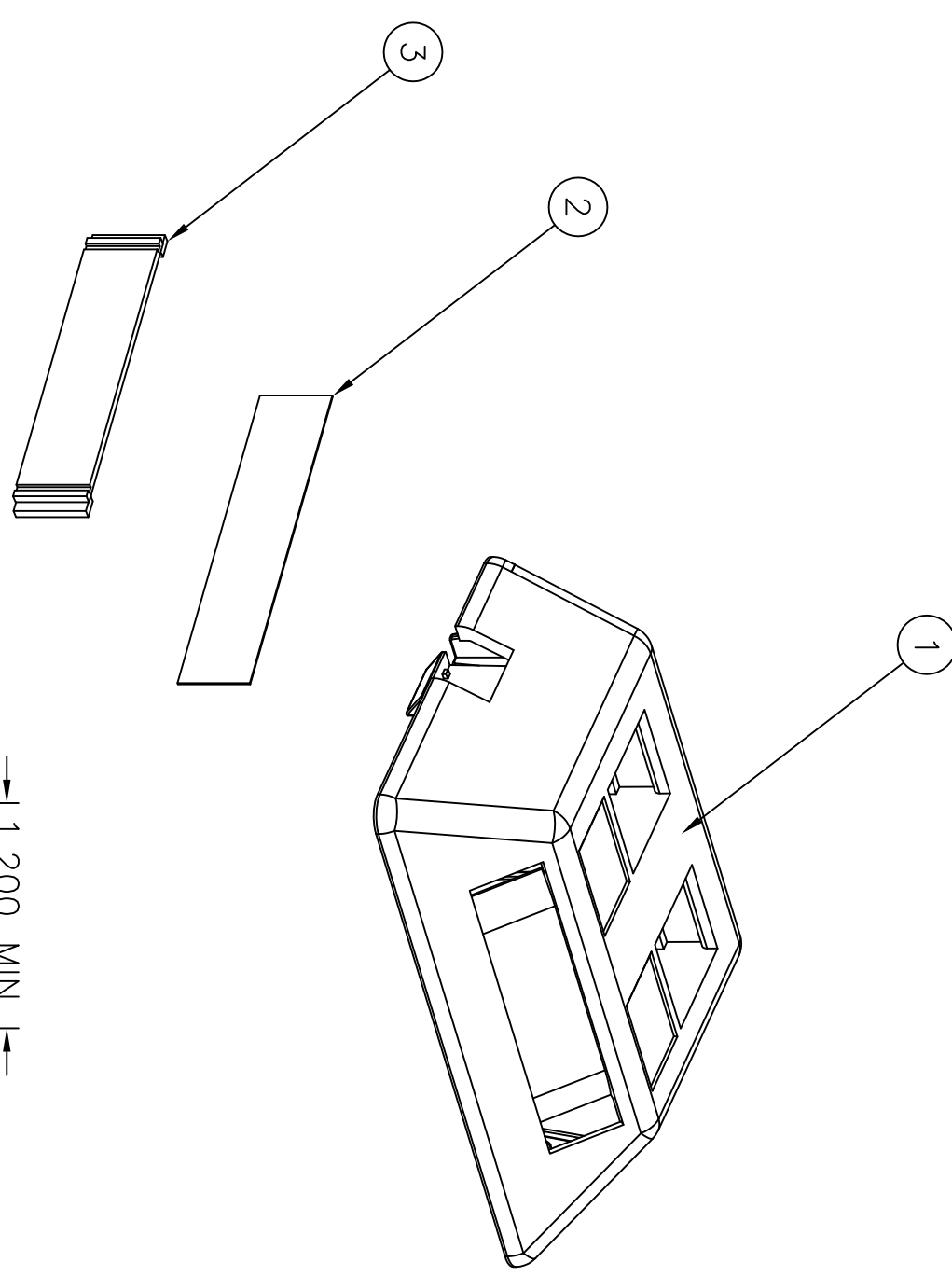
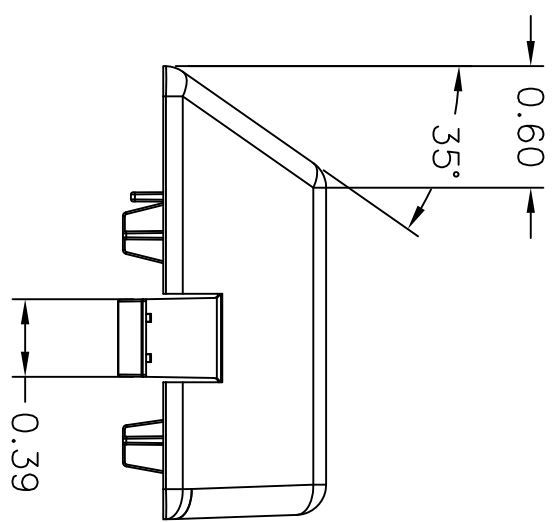
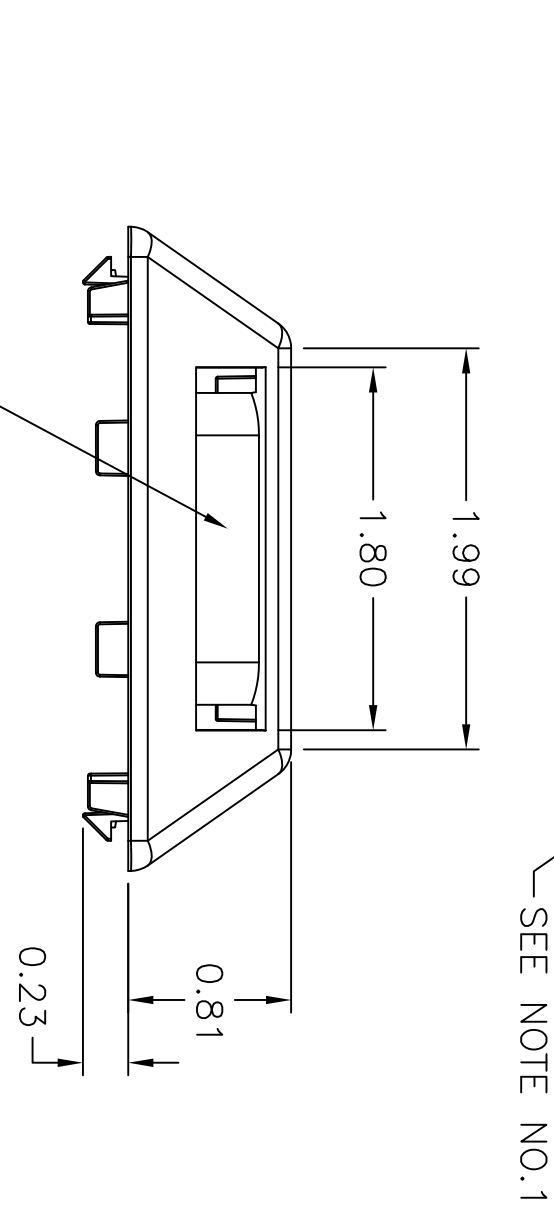
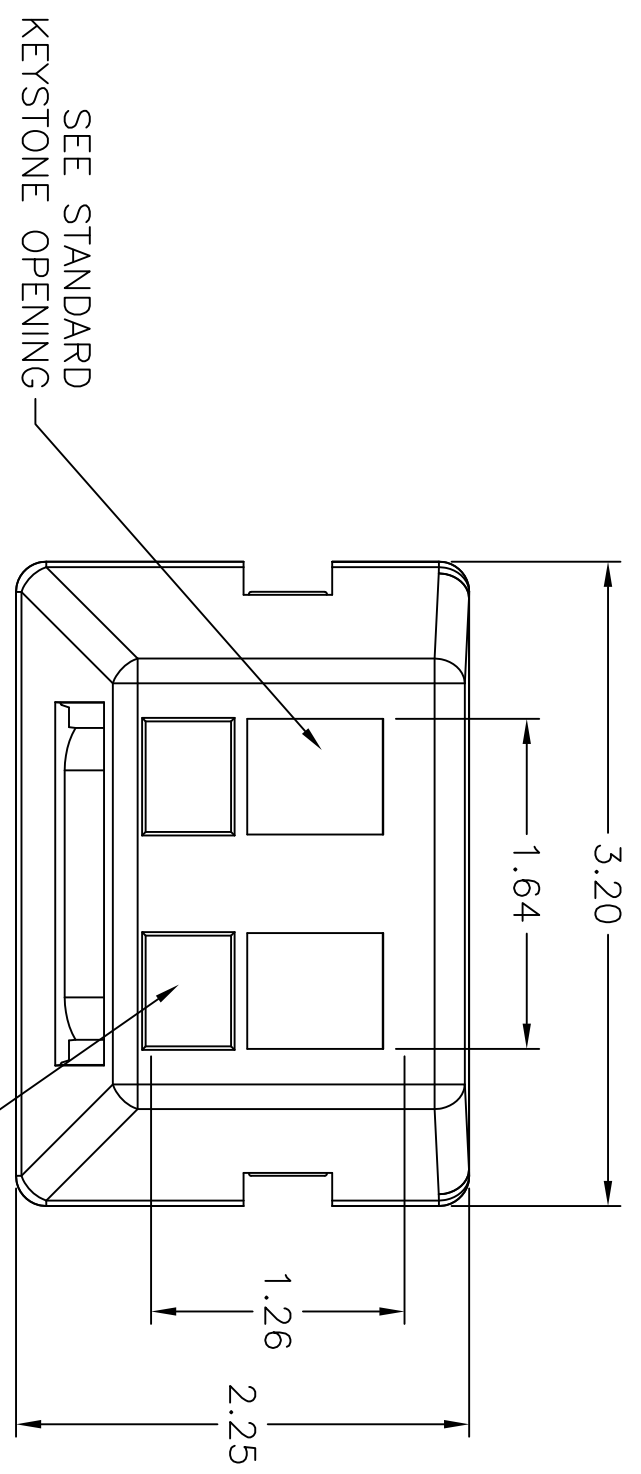
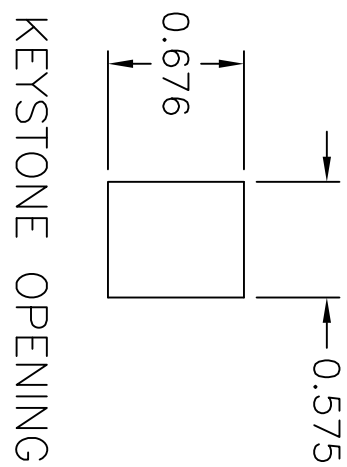
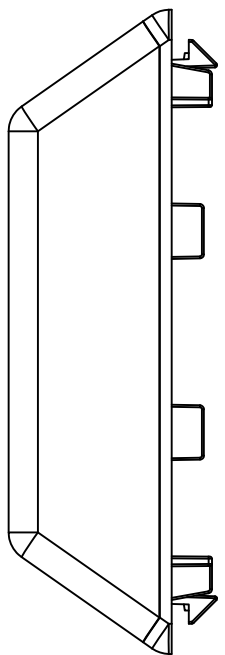

NOTES:

1. LABEL FIELDS – HUBBELL PORT IDENTIFIERS PART NO. XPLPP10W
2. LABEL FIELDS – HUBBELL STATION LABEL PART NO. XPLFP10W
3. UL LISTED
4. FITS STANDARD ANSI/TIA/EIA FURNITURE OPENING SIZE (SEE DETAIL)
5. SPECIFICATIONS SUBJECT TO CHANGE WITHOUT PRIOR NOTICE

REV.	ECN	DATE	DESCRIPTION	CHG BY	APPD BY
B	17889	03/20/12	ADDED 3 COLORS	MMA	

Created on AUTOCAD

DIMENSIONING AND TOLERANCE PER ANSI Y14.5M-1982 UNLESS OTHERWISE SPECIFIED, DIMENSIONS ARE IN INCHES (MM). TOLERANCES
 .XX = ±.01 (.25)
 .XXX = ±.005 (.127)
 .XXXX = ±.0025 (.0635)
 ANGLE TOL. ±1°

IN ACCEPTING OUR DRAWINGS, BLUEPRINTS, OR SUPPORTING DOCUMENTATION FOR QUOTATION OR OTHER PURPOSES, YOU AGREE NOT TO DISCLOSE TO OTHERS THE IDEAS, INFORMATION, OR DESIGNS SHOWN HEREIN, AND THAT YOU WILL MAKE NO USE OF SAME WITHOUT PERMISSION

PROJECT REFERENCE:

MATERIAL:

DRAWN BY: PAUL S. MAGUIRE 05/06/02

CHECKED BY:

APPROVED BY:

Hubbell Premise Wiring
 HUBBELL INCORPORATED (Delaware)
 14 Lord's Hill Road, Stonington, Connecticut 06378

TITLE: PLATES/HOUSINGS/FRAMES FURNITURE PLATES
 2 PORT FURNITURE PLATE (STANDARD OPENING)

SIZE: C DRAWING NO. 773276C

SCALE: 1/1 SHEET 1 OF 1

REV. B