

## RS Up Light STANDARD BASE



PROJECT

CATALOG #

TYPE

NOTES

The Core of the FX Up Light Family. The RS allows designers to use different lamps to create custom effects while maintaining consistency in style. With knowledge of the science and art of lighting, a professional designer can choose a lamp source to suit the desired effect or emotional response.

### Quick Facts

- Die-cast zinc/aluminum
- TGIC powder coat finish alloy
- MR-16 lamp type
- Compatible with Luxor® technology
- ProAim™ adjustability
- Input voltage: 10-15V

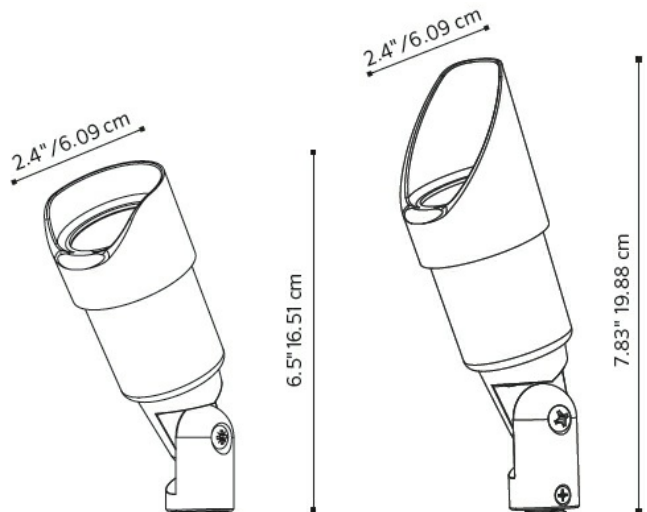

# RS Up Light SPECIFICATIONS

Output	LED20WFL	ECO20WFL	LED35WFL	ZD35WFL
<b>Total Lumens</b>	250	383*	335	310
<b>Input Voltage</b>	10 to 15V	10 to 15V	10 to 15V	10 to 15V
<b>Input Power (W)</b>	4.0	4.0	5.0	5.0
<b>VA</b>	4.3	6.2	5.4	5.4
<b>Efficacy (Delivered)</b>	62	50	67	67
<b>CRI (Ra)</b>	80+	80+	80+	80+
<b>Center Beam Candlepower (CBCP)</b>	570	541	660	660
<b>CCT</b>	2,700K	2,700K	2,700K	2,700K
<b>Beam Angle</b>	35°	35°	35°	35°
<b>Dimming</b>	PWM, Phase**	PWM, Phase**	PWM, Phase**	PWM, Phase**
<b>Luxor Compatibility</b>				
<b>ZD Option</b>	Use Luxor Cube (e.g., LCMLV)	Use Luxor Cube (e.g., LCMLV)	Use Luxor Cube (e.g., LCMLV)	Zoning/Dimming
<b>Minimum Rated Life (hrs L90 B10)</b>	40,000	30,000	40,000	40,000

\* Total Lamp Lumens

\*\* For optimal performance, use a trailing-edge, phase-cut dimmer.

## About FX Luminaire

As a leading manufacturer of landscape and architectural lighting, FX Luminaire provides innovative products, resources, and support to help customers bring their visions to life. The company offers a range of specification-driven solutions, including fixtures, controls, and accessories, to enhance residential and commercial landscapes.

## Materials

Zinc/aluminum alloy housing, shroud, and knuckle with stainless steel hardware

## Knuckle

Machined brass knuckle with ½"-14 (13 mm) NPSM threads. Compress and lock features prevent slip after installation. Complete adjustability over 220° of vertical adjustment.

## LED

GU5.3 lamp base. Preinstalled LED MR-16 with Cree LEDs offers a warm 2,700K color temperature with a minimum rated life (L90) 40,000 hours.

## Optics

Stainless steel spring in housing ensures the lamp and additional lenses stay flush against the glass lens, optimizing output and beam angles. Recess the lamp farther inside the housing to hide additional glare with the Recessor Ring (specify separately). For additional color filters, spread lenses, hex baffles, etc., use MR-16 sized accessories (MR-16: 2" (50 mm) dia. x 1 mm thickness).

## Finish

Durable polyester TGIC powder coat finish, providing superior outdoor weathering in all conditions. Tested to ASTM standards.

## Hardware

Stainless steel angle lock screw. Includes 10" (254 mm) ABS slotted installation spike.

## Wiring

18 AWG (1 mm); SPT-1W; 220°F (105°C); 300V; 10' (3 m) length.

## Sockets

MR16 GU5.3 socket with retaining clips. Ceramic socket base with heat-resistant contact pad. Stainless steel retaining clips ensure high spring force retention.

## Power

Input 10–15 VAC/VDC, 50/60 Hz. Remote transformer required (specify separately).

## Housing

Die-cast zinc/aluminum alloy housing with capacity for one (1) standard MR-16 lamp.

## Glare Control

Die-cast zinc/aluminum alloy shroud with 15° (standard) or 45° (long shroud) cutoff options.

## Weight

2.6 lbs. (1.2 kg)

## Lens

Tempered, low-iron, soda-lime glass lens with shock resistance and high tolerance for thermal expansion and stress.

## Ambient Operating Temperature

0°F to 140°F (-18°C to 60°C)

## Installation Requirements

Designed for installation in the upward direction only. Use waterproof, weather resistant wire connectors.

## Control

ZD option utilizes Luxor technology to zone light fixtures in up to 250 groups, and dim each group in 1% increments between 0 and 100%. An installed Luxor controller is required to perform these actions.

## Manufacturing

ISO 9001:2015 certified facility. Fixture assembled in Mexico; lamp made in China.

## Warranty



10-year limited warranty on fixture; 5-year limited warranty on preinstalled FX Luminaire LED lamp.

## Listings



# RS Up Light ORDERING INFORMATION

[field\_spec\_builder\_mount] [field\_spec\_builder\_mount]

Fixture	Power	Shroud	Finish
<b>RS</b>	<b>LED20WFL</b> 4.3 VA, 2700K, 35° LED MR-16 lamp (PRO lamp series)	[default]	<b>BZ</b> Bronze Metallic 
	<b>ECO20WFL</b> 6.0 VA, 2700K, 30° LED MR-11 lamp (ECO lamp series)	<b>LS</b> 45° Angled Long Shroud	<b>FB</b> Black 
	<b>LED35WFL</b> 5.4 VA, 2700K, 35° LED MR-16 lamp (LED lamp series)		<b>DG</b> Desert Granite 
	<b>ZD35WFL</b> 5.4 VA, 2700K, 35° LED MR-16 lamp (ZD lamp series)		<b>WI</b> Weathered Iron 
	<b>NL</b> Lamp not included		<b>SB</b> Sedona Brown 



EXAMPLE FIXTURE CONFIGURATION: RS-XX-XXXX-XX























## RS LED20WFL - Illuminance at a Distance

Distance	Center Beam fc	Beam Width
Feet (Meters)	Foot-Candles (Lux)	Vertical : 35 °
3' (0.9 m)	84 fc (904 lx)	1.6' (0.5 m)
6.0' (1.8 m)	21 fc (226 lx)	3.2' (1.0 m)
9.0' (2.7 m)	9 fc (97 lx)	4.7' (1.4 m)
12.0' (3.7 m)	5 fc (54 lx)	6.3' (1.9 m)
15' (4.6 m)	3 fc (32 lx)	7.9' (2.4 m)
18' (5.5 m)	2 fc (22 lx)	9.5' (2.9 m)

## RS LED35WFL - Illuminance at a Distance

Distance	Center Beam fc	Beam Width
Feet (Meters)	Foot-Candles (Lux)	Vertical : 35 °
3' (0.9 m)	94 fc (1,012 lx)	1.7' (0.5 m)
6.0' (1.8 m)	24 fc (258 lx)	3.4' (1.0 m)
9.0' (2.7 m)	10 fc (108 lx)	5.1' (1.6 m)
12.0' (3.7 m)	6 fc (65 lx)	6.8' (2.1 m)
15' (4.6 m)	4 fc (43 lx)	8.4' (2.6 m)
18' (5.5 m)	3 fc (32 lx)	10.1' (3.1 m)



## MOUNTING OPTIONS: Specify Separately

Mounts	Catalog No.		Mounts	Catalog No.	
Long Slot Spike	250015840000		Three-Prong Spike	250020020000	
Lock Ring	250030410000SP		Super Slot Spike	753900	
Straight Coupling	COUP-XX*		90° Coupling	ELBW-050-XX*	
Gutter Mount	GM-SS		Ground Mount with 1/2" Thread	GM-XX*	
Mini J-Box for 1/2" Thread	MJB-050-XX*		Mini Mount	MM-050-XX*	
ProAim® Ratcheting Spike	PARS		Post Mount	PM-XX*	
Super J-Box Spike	SJ-XX*		TreeBox® Mount with 1/2" Thread	TB-XX*	
T-Mount Coupling with 1/2" Thread	TMNT-050-XX*		Tree Ring	TR-YY*-8P-XX*	
VersaBox® Mount with 1/2" Thread	VB-050-XX*		Variable Height Riser for Up Lights	VHR-UL	
Wall Mount Knuckle	WM-XX*		Single-Gang Wall Plate with 1/2" Thread	WP-1G-050-XX*	
Round Wall Plate with 1/2" Thread	WP-RD-050-XX*		Sign Light Riser, Aluminum	YY*-R-SL-XX*	
Aluminum Riser, 3/4" Diameter	YY*-R-XX*				

GLARE CONTROL: Specify Separately

Glare Control	Catalog No.		Glare Control	Catalog No.	
Hex Baffle for MR-16 LED Lamps	250015260000		RecessorRing® Spacer for MR-16 LED Lamps	RR-MR16	

POWER OPTIONS: Specify Separately

Power	Catalog No.	
Plug-In Transformer, 6 W	MT-6W	
Surge Protection Module	SURGE-MOD	
-		

Power	Catalog No.	
Step-Down Transformer, UV (120/277 V to 12 V)	ST-UV	