

QL Down Light **DESIGNER BASE**



PROJECT

CATALOG #

TYPE

NOTES

At 1.5" (38 mm) wide, the compact QL down light is ideal for mounting on narrow posts, perimeter fencing, pool enclosures, columns, doorways, and pergolas.

Quick Facts

- Tamper-resistant features
- Die-cast aluminum
- Input voltage: 10-15V
- Compatible with Luxor® technology
- Two-layer, marine-grade anodization and powder-coat finish
- Cree® integrated LED
- Phase and PWM dimmable

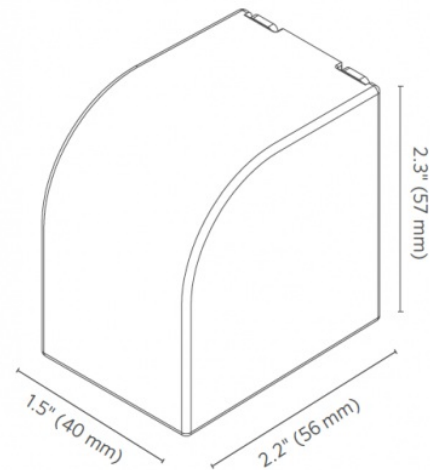

Output	1LED
Total Lumens †	53
Input Voltage	10 to 15V
Input Power (W)	2.0
VA	2.4
Efficacy (Lumens/Watt)	27
Color Redering Index (CRI)	80+
Center Beam Candlepower*	
Spot (17-20)	51
Dimming	PWM, Phase**
RGBW Available	No
Luxor Compatibility	
Default	Zoning
ZD Option	Zoning/Dimming
ZDC Option	--
Minimum Rated Life (L90 B10)	55,000 Hrs

* Information not available for Flood or Wide Flood.

** For optimal performance, use trailing edge phase cut dimmer

† Measured using the 3900K CCT lens. Multipliers for other CCT's include 0.80 (2700K), 0.65 (4500K), and 0.65 (5200K)

About FX Luminaire

As a leading manufacturer of landscape and architectural lighting, FX Luminaire provides innovative products, resources, and support to help customers bring their visions to life. The company offers a range of specification-driven solutions, including fixtures, controls, and accessories, to enhance residential and commercial landscapes.

Materials

Die-cast A380 aluminum body with stainless steel setscrew, mounting bracket, and fasteners.

LED

Integrated module with Cree LEDs. Gold-plated connectors and conformal coating for maximum reliability and corrosion resistance. Proprietary onboard intelligent driver uses firmware-controlled temperature regulation, maximizing LED life. Field upgradeable and replaceable, the LEDs are rated to 55,000 hrs. Maximum drive current: 1 A.

Optics

Polycarbonate color temperature adjustment lens included with fixture: 2,700K (preinstalled) and 3,900K (no lens). Interchangeable optics for 10°, 20°, 30°-32°, or 55-58° (preinstalled) distributions available. Color temperature and beam angle lenses field serviceable.

Finish

Two-layer protection of sulfuric acid anodization and polyester TGIC powder coat, providing superior outdoor weathering in all conditions. Tested to ASTM standards.

Hardware

Stainless steel mounting plate and two screws included.

Sockets

Socket contains MoistureBlock™ technology, preventing moisture from wicking up into sealed areas of the fixture.

Power

Input 10-15 VAC/VDC, 50/60 Hz. Remote transformer required (specify separately).

Housing

Die-cast A380 aluminum body with capacity for 1LED integrated LED board.

Weight

0.36 lbs. (0.16 kg)

Lens

Polycarbonate clear lens with shock resistance and high tolerance for thermal expansion and stress.

International Compliance

Compliant per IEC 60598-1 and IEC 60598-2-7 by selecting the "e" option in the parts builder.

Ambient Operating Temperature

0°F to 140°F (-17°C to 60°C)

Installation Requirements

Designed for installation in the downward direction only.

Control







ZD utilizes Luxor technology to zone fixtures in up to 250 groups and dim each group in 1% increments between 0 and 100. Select the ZD option for zoning/dimming. Standard fixture is zoneable with Luxor controller.

Warranty

Listings



[field_spec_builder_mount] [field_spec_builder_mount]

Fixture	Control	Power	Compliance	Finish
QL	[Default] Zone with Luxor, On/Off, Phase Dimmable	1 LED 2.0W/2.4VA	[default] North America (UL Listed)	BZ Bronze Metallic 
	ZD Zone/Dim with Luxor			E International (CE Certified)
				DG Desert Granite 
				WI Weathered Iron 
				SB Sedona Brown 
				FW Flat White 
				SV Silver 



EXAMPLE FIXTURE CONFIGURATION: QL-ZD-1LED-FB

QL 1LED - Illuminance at a Distance

Distance	Center Beam fc	Beam Width	
Feet (Meters)	Foot-Candles (Lux)	Vertical : 59 °	Horizontal : 54.8 °
1' (0.3 m)	50.6 fc (545 lx)	1.1' (0.3 m)	1.0' (0.3 m)
2' (0.6 m)	12.6 fc (135 lx)	2.3' (0.7 m)	2.1' (0.6 m)
3' (0.9 m)	5.6 fc (60 lx)	3.4' (1.0 m)	3.1' (1.0 m)
4' (1.2 m)	3.2 fc (35 lx)	4.5' (1.4 m)	4.1' (1.3 m)
5' (1.5 m)	2.0 fc (22 lx)	5.7' (1.7 m)	5.2' (1.6 m)
6.0' (1.8 m)	1.4 fc (15 lx)	6.8' (2.1 m)	6.2' (1.9 m)

MOUNTING OPTIONS: Specify Separately

Mounts	Catalog No.	Mounts	Catalog No.
Single-Gang Wall Plate for the QL Down Light	WP-1G-QL-XX*		

