

## PB LED Up Light DESIGNER PREMIUM



---

PROJECT

---

CATALOG #

---

TYPE

---

NOTES

---

The PB is a compact LED Wall Wash lighting solution. Available in one or three LED, and ZDC options. The wider angle of the PB allows a broader lighting option for larger structures and spaces. Engineered with solid construction, yet petite in size.

### Quick Facts

- Die-cast aluminum or brass
- Natural brass and antique finishes
- ProAim™ adjustability
- Phase and PWM dimmable
- Two-layer marine-grade anodization and powder coat finish
- Lumileds® Integrated LEDs
- Compatible with Luxor® technology
- Input voltage: 10-15V

PB DIMENSIONS

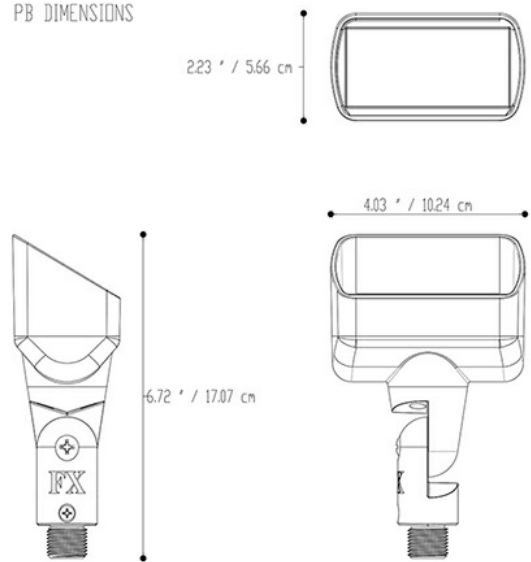

# PB LED Up Light SPECIFICATIONS

Output	1LED	3LED	3LEDT	ZDC
Total Lumens†	104	265	146	122
Input Voltage	10 to 15V	10 to 15V	10 to 15V	11 to 15V
Input Power (W)	1.9	4.0	4.2	6.0
VA	2.2	4.4	4.5	7.2
Efficacy (Lumens/Watt)	57	68	42	37
Color Rendering Index (CRI)	83	84	--	83
Center Beam Candlepower			304	122
Ver Wide Flood (90)	53	136		
Dimming	PWM, Phase**	PWM, Phase**	PWM, Phase**	--
RGBW Available	No	No	No	Yes
Luxor Compatibility				
Default	Zoning	Zoning	--	Zoning
ZD Option	Zoning/Dimming	Zoning/Dimming	Zoning/Dimming	--
ZDC Option	--	--	--	Zoning/Dimming/Color
Minimum Rated Life (L70)	L70 (hrs) 72,000	L70 (hrs) 72,000	L70 (hrs) 72,000	L70 (hrs) 72,000

\*\* For optimal performance, use a trailing-edge, phase-cut dimmer.

† Measured using the 3,900K CCT lens. Multipliers for other CCTs include 0.80 (2,700K), 0.65 (4,500K), and 0.65 (5,200K).

# PB LED Up Light SPECIFICATIONS

## About FX Luminaire

As a leading manufacturer of landscape and architectural lighting, FX Luminaire provides innovative products, resources, and support to help customers bring their visions to life. The company offers a range of specification-driven solutions, including fixtures, controls, and accessories, to enhance residential and commercial landscapes.

## Materials

Die-cast C360 brass housing, shroud, and knuckle/base assembly with brass hardware.

## Knuckle

Die-cast brass knuckle with ½"-14 (13 mm) NPSM threads. Compress and lock features prevent slip after installation. 9° increments adjustability over 220

## LED

Integrated module with Cree LEDs. Gold-plated connectors and conformal coated for maximum reliability and corrosion resistance. Proprietary on-board intelligent driver uses firmware-controlled temperature regulation, maximizing LED life. Field upgradeable and replaceable, the LEDs are rated to 50,000 hrs. Maximum drive current: 1 A.

## Optics

Polycarbonate color temperature adjustment lenses included with fixture: 2,700K (preinstalled), 3,900K (no lens), 4,500K, and 5,200K. Color temperature lenses field serviceable. Beam angle is calculated using LM-79 method for SSL luminaires.

## Finish

Options of natural brass finish, or antiqued finish with brushed (Antique Bronze) or tumbled (Antique Tumbled) effect. Antique finishes sealed with a clear TGIC powder coat layer

## Hardware

Brass angle lock screw with setscrew. Includes ProAim ratcheting ABS spike for 360° horizontal rotation in 10° increments. Tamperresistant locking screw included.

## Wiring

18 AWG (1 mm); SPT-1W; 220°F (105°C); 300V; 10' (3 m) length.

## Sockets

Socket contains MoistureBlock™ technology, preventing moisture from wicking up into sealed areas of the fixture.

## Power

Input 10-15VAC/VDC 50/60Hz. Remote transformer required (specify separately).

## Housing

Die-cast brass housing with capacity for 1LED, 3LED, or ZDC integrated LEDs.

## Glare Control

Die-cast brass shroud with 30° cutoff.

## Weight

2.4 lbs. (1.1 kg)

## Lens

Tempered frosted glass lens with shock resistance and high tolerance for thermal expansion and stress.

## Ambient Operating Temperature

0°F to 140°F (-18°C to 60°C)

## Installation Requirements

Designed for installation in the upward direction only.

## Control

ZD or ZDC options utilize Luxor technology to zone light fixtures in up to 250 groups, dim each group in 1% increments between 0 and 100%, or change to one of 30,000 colors with RGBW LEDs. Select the ZD option for zoning/dimming or ZDC for zoning/dimming/color. Standard fixture is zoneable with Luxor

## Manufacturing

ISO 9001:2015 certified facility

## Warranty

10-year limited warranty

## Listings



# PB LED Up Light ORDERING INFORMATION

[field\_spec\_builder\_mount] [field\_spec\_builder\_mount]

FixtureControl	Power	Color Temp	Compliance	Finish
<b>PB</b> <b>[Default]</b> Zone with Luxor, On/Off, Phase Dimmable	<b>1 LED</b> 2.0W/2.4VA	<b>[Default]</b> Warm (2700K)	<b>[default]</b> North America (UL Listed)	<b>BZ</b> Bronze -Metallic
<b>ZD</b> Zone/Dim with Luxor	<b>3 LED</b> 4.0W/4.4VA	<b>S</b> Soft (3000K)	<b>E</b> International (CE Certified)	<b>FB</b> Black
<b>ZDC</b> Zone/Dim/Color with Luxor	<b>3 LEDT</b> Wildlife-Friendly Amber (585-595 nm)	<b>C</b> Cool (4000K)		<b>DG</b> Desert -Granite
	<b>[default ZDC option]</b> 6.0W/7.2VA	<b>[Default]</b> RGBW, ZDC Option Required		<b>WI</b> Weathered -Iron
				<b>SB</b> Sedona -Brown
				<b>FW</b> Flat White
				<b>SV</b> Silver
				<b>AB</b> Antique -Bronze
				<b>AT</b> Antique -Tumbled
				<b>NP</b> Nickel Plate
				<b>BS</b> Natural Brass



EXAMPLE FIXTURE CONFIGURATION: *PB*-XX-XXXX-XX

## PB-1LED - Illuminance at a Distance

Distance	Center Beam fc	Beam Width	
Feet (Meters)	Foot-Candles (Lux)	Vertical : 77.2 °	Horizontal : 90.8 °
3' (0.9 m)	5.9 fc (63 lx)	4.8 ft (1.5 m)	6.1 ft (1.9 m)
6.0' (1.8 m)	1.5 fc (16 lx)	9.6 ft (2.9 m)	12.2 ft (3.7 m)
9.0' (2.7 m)	0.7 fc (7 lx)	14.4 ft (4.4 m)	18.2 ft (5.5 m)
12.0' (3.7 m)	0.4 fc (4 lx)	19.2 ft (5.9 m)	24.3 ft (7.4 m)
15.0' (4.6 m)	0.2 fc (3 lx)	23.9 ft (7.3 m)	30.4 ft (9.3 m)
18.0' (5.4 m)	0.2 fc (2 lx)	28.7 ft (8.7 m)	36.5 ft (11.1 m)

## PB-3LED - Illuminance at a Distance

Distance	Center Beam fc	Beam Width	
Feet (Meters)	Foot-Candles (Lux)	Vertical : 77.1 °	Horizontal : 91.8 °
3' (0.9 m)	15 fc (161 lx)	4.8 ft (1.5 m)	6.2 ft (1.9 m)
6.0' (1.8 m)	3.8 fc (40 lx)	9.6 ft (2.9 m)	12.4 ft (3.8 m)
9.0' (2.7 m)	1.7 fc (18 lx)	14.4 ft (4.4 m)	18.6 ft (5.7 m)
12.0' (3.7 m)	0.9 fc (10 lx)	19.1 ft (5.8 m)	24.8 ft (7.6 m)
15.0' (4.6 m)	0.6 fc (6 lx)	23.9 ft (7.3 m)	30.9 ft (9.4 m)
18.0' (5.4 m)	0.4 fc (5 lx)	28.7 ft (8.7 m)	37.1 ft (11.3 m)

























## PB-3LEDT - Illuminance at a Distance

Distance	Center Beam fc	Beam Width	
Feet (Meters)	Foot-Candles (Lux)	Vertical : 29.2 °	Horizontal : 30.3 °
4.0' (1.2 m)	19 fc (203 lx)	2 ft (0.6 m)	2.2 ft (0.7 m)
8.0' (2.4 m)	5 fc (60 lx)	4 ft (1.3 m)	4.3 ft (1.3 m)
12.0' (3.7 m)	2 fc (23 lx)	6 ft (1.9 m)	6.5 ft (2.0 m)
16.0' (4.9 m)	1.2 fc (13 lx)	8 ft (2.5 m)	8.7 ft (2.7 m)
20.0' (6.1 m)	0.8 fc (9 lx)	10 ft (3.2 m)	10.8 ft (3.3 m)
24.0' (7.3 m)	0.5 fc (5 lx)	13 ft (3.9 m)	13 ft (3.9 m)

## PB-ZDC - Illuminance at a Distance



Distance	Center Beam fc	Beam Width	
Feet (Meters)	Foot-Candles (Lux)	Vertical : 52.3 °	Horizontal : 54.1 °
4.0' (1.2 m)	7.6 fc (82 lx)	4 ft (1.2 m)	4 ft (1.3 m)
8.0' (2.4 m)	1.8 fc (21 lx)	8 ft (2.4 m)	8 ft (2.5 m)
12.0' (3.7 m)	0.9 fc (10 lx)	12 ft (3.6 m)	12 ft (3.8 m)
16.0' (4.9 m)	0.5 fc (5 lx)	16 ft (4.8 m)	16 ft (5.0 m)
20.0' (6.1 m)	0.3 fc (3 lx)	20 ft (6.0 m)	20 ft (6.2 m)
24.0' (7.3 m)	0.2 fc (2 lx)	24 ft (7.2 m)	25 ft (7.5 m)

MOUNTING OPTIONS: Specify Separately

Mounts	Catalog No.		Mounts	Catalog No.	
Long Slot Spike	250015840000		Three-Prong Spike	250020020000	
Lock Ring	250030410000SP		Super Slot Spike	753900	
Straight Coupling	COUP-XX*		90° Coupling	ELBW-050-XX*	
Gutter Mount	GM-SS		Ground Mount with 1/2" Thread	GM-XX*	
Mini J-Box for 1/2" Thread	MJB-050-XX*		Mini Mount	MM-050-XX*	
ProAim® Ratcheting Spike	PARS		Post Mount	PM-XX*	
Super J-Box Spike	SJ-XX*		TreeBox® Mount with 1/2" Thread	TB-XX*	
T-Mount Coupling with 1/2" Thread	TMNT-050-XX*		Tree Ring	TR-YY*-8P-XX*	
VersaBox® Mount with 1/2" Thread	VB-050-XX*		Variable Height Riser for Up Lights	VHR-UL	
Wall Mount Knuckle	WM-XX*		Single-Gang Wall Plate with 1/2" Thread	WP-1G-050-XX*	
Round Wall Plate with 1/2" Thread	WP-RD-050-XX*		1.0" (25 mm) Copper Riser for GT Path Light	YY*-R-GT-XX*	
Sign Light Riser, Aluminum	YY*-R-SL-XX*		Aluminum Riser, 3/4" Diameter	YY*-R-XX*	

# PB LED Up Light ORDERING INFORMATION

POWER OPTIONS: Specify Separately

Power	Catalog No.	
Plug-In Transformer, 6 W	MT-6W	
Surge Protection Module	SURGE-MOD	
-		

Power	Catalog No.	
Step-Down Transformer, UV (120/277 V to 12 V)	ST-UV	