

User Manual

AC-EX100-444-KIT-GEN2

Ultra Slim 100m (100m HD) 4K60 4:4:4, HDR HDBaseT Extender Audio Extraction, EDID Management, Scaling & Ethernet, USB Selectable Host



AVProEdge
2222 E 52nd St N ~ Sioux Falls, SD 57104 1-877-886-5112 ~ 605-274-6055
support@avproedge.com

AVPro Edge presents its 18Gbps over copper extender. Using ICT (Invisible Compression Technology) we have achieved what was thought to be impossible. We can deliver a virtually lossless high bandwidth 4K HDR signal with support for all signals up to 18Gbps. Deep Color and HDR Metadata remain intact making the transmission free of artifacts like banding. Other similar devices will deliver a sub-par image that has very visible banding and color shifting.

Product Overview

Model Numbers:

- **AC-EX100-444-T-GEN2** ~ HDBaseT Transmitter w/ Audio Extraction, IR, RS-232, EDID, ARC, Test Patterns and Scaler
- **AC-EX100-444-R-GEN2** ~ HDBaseT Receiver w/ IR, RS-232, ARC, Test Patterns

Features

- HDMI 2.0(a/b)
- 18Gbps Bandwidth Support (Using ICT)
- Up to 4K60 4:4:4 Support
- HDR, HDR10+, HLG, and Dolby Vision Support
- HDR, HDR10+ and HLG Support
- 4K --> 1080P Down-scaling for mixed systems
- Audio Return Channel on HDMI or TOSLINK (ARC)
- EDID Management and EDID emulate
- 4K & HD Test Patterns built into Tx and Rx for troubleshooting
- Audio Extraction via TOSLINK on Tx
- Audio Input via TOSLINK on RX
- HDCP 2.2 (and all earlier versions supported)
- USB Extension (Selectable Host)
- CEC Pass Through
- 3D Support
- 70M (230ft) on 1080P (Cat6a)
- Up to 40M (131ft) on 4K (up to 4K60 4:4:4, HDR) (Cat6a)
- Bi-directional 48v PoH (Power Over HDBaseT, only one Power Supply Needed)
- I-Pass Feature for control system "pass-through"
- 3-20v protection circuit built in for safe IR transport
- Bi Directional RS232 Transport
- LED Status, Link, Power indication lights
- Use single UTP/STP LAN cable (CAT-6A) with substitute HDMI cable to achieve long distance transmission
- Supports uncompressed PCM 2- Ch., LPCM 5.1 & 7.1, Dolby Digital, DTS, Dolby TrueHD, DTS HD-Master Audio, Atmos on HDMI
- ESD protection circuitry (Inputs & Outputs) to 7KV
- Can Cascade

Whats in the box

- AC-EX100-444-T-GEN2 (Transmitter)
- AC-EX100-444-R-GEN2 (Receiver)
- 48V Power Supply (One supplied)
- 1 x IR Tx Unit
- 1 x IR Rx Unit
- 4x 3 Pin Terminal blocks for Audio and RS232 Ports
- Mounting Brackets

***NOTE: Optional 3PIN to STEREO Audio Cables available for purchase "AC-CABLE-3PIN-2CH"**

VIDEO:	
VIDEO RESOLUTIONS	UP TO 4K 60HZ 4:4:4
VESA RESOLUTIONS	UP TO DCI 4K (4096X2160)
HDR FORMATS/RESOLUTIONS	420, 422, 444 (10 AND 12 DEEP COLOR) HDR10, HDR10+, DOLBY VISION (24/30 FRAMES), AND HLG
COLOR SPACE	YUV (COMPONENT), RGB (CSC: REC. 601, REC. 709, BT2020, DCI, P3 D6500)
CHROMA SUBSAMPLING	4:4:4, 4:2:2, 4:2:0 SUPPORTED
DEEP COLOR	UP TO 16 BIT (1080), UP TO 12 BIT (4K)
DOWN SCALING	4K (AND HDR) DOWN TO 1080P
AUDIO:	
AUDIO FORMATS SUPPORTED HDMI	PCM 2.0 CH, LPCM 5.1 & 7.1, DOLBY DIGITAL, DTS 5.1, DOLBY DIGITAL PLUS, DOLBY TRUEHD, DTS-HD MASTER AUDIO, DTS-X, DOLBY ATMOS
AUDIO FORMATS SUPPORTED EXTRACTED (TOSLINK, TX ONLY)	PCM 2.0 CH, LPCM 5.1 & 7.1, DOLBY DIGITAL, DTS 5.1, DOLBY DIGITAL PLUS, DOLBY TRUEHD, DTS-HD MASTER AUDIO
ARC:	
FORMATS SUPPORTED HDMI ARC OUT TX	PCM 2.0 CH, LPCM 5.1 & 7.1, DOLBY DIGITAL, DTS 5.1, DOLBY DIGITAL PLUS, DOLBY TRUEHD, DTS-HD MASTER AUDIO, DTS-X, DOLBY ATMOS
FORMATS SUPPORTED TOSLINK OUT TX	PCM 2.0 CH, LPCM 5.1 & 7.1, DOLBY DIGITAL, DTS 5.1, DOLBY DIGITAL PLUS, DOLBY TRUEHD, DTS-HD MASTER AUDIO
DISTANCE:	
HDBASET (CAT) DISTANCE (4K)	100 METERS / 330 FEET (CAT 6A)
HDBASET (CAT) DISTANCE (FULL HD)	100 METERS / 330 FEET (CAT 6A)
HDMI LEAD IN/OUT (4K60 4:4:4)	UP TO 50 FEET (USING BULLET TRAIN HDMI)
HDMI LEAD IN/OUT (W/ AOC CABLE) (4K60 4:4:4)	UP TO 130 FEET (USING BULLET TRAIN AOC)
OTHER:	
BANDWIDTH	18 GBPS (W/ ICT)
HDCP	HDCP 2.2 AND EARLIER
PORTS:	
HDMI (TX & RX)	TYPE A
HDBASET	RJ45 W/ POH FOR HDBASET RECEIVERS
EXTRACTED AUDIO (TX ONLY, RX IS AN AUDIO INPUT)	TOSLINK
IR TX (TX & RX)	3.5MM MONO (2 CONDUCTOR)
IR RX (TX & RX)	3.5MM STEREO (3 CONDUCTOR)
RS232 (TX & RX)	3 PIN TERMINAL BLOCK
POWER (TX & RX)	2 PIN TERMINAL BLOCK
ETHERNET (TX & RX)	4x RJ45 CONNECTIONS (10/100)
USB SELECTABLE HOST:	
VERSION	USB 2.0
TX PORT	USB HOST = USB TYPE B (X2) USB TYPE A (X1)
RX PORT	USB HOST = USB TYPE B (X2) USB TYPE A (X1)
ENVIRONMENTAL:	
OPERATING TEMPRATURE	23 TO 125°F (-5 TO 51°C)
STORAGE TEMPERATURE	-4 TO 140°F (-20 TO 60°C)
HUMIDITY RANGE	5-90% RH (NO CONDENSATION)
POWER:	
POWER CONSUMPTION (TOTAL)	12 WATTS MAX
POWER SUPPLY - MATRIX	INPUT: AC 100-240V ~ 50/60HZ OUTPUT: DC 48V 0.5A
DIMENSIONS:	
DIMENSIONS (SINGLE UNIT ONLY, HEIGHT/DEPTH/WIDTH)	MM: 113.68 X 196.85 X 21.8 INCH: 4.48 X 7.75 X 0.86
DIMENSIONS (KIT PACKAGED, HEIGHT/DEPTH/WIDTH)	MM: 184.15 X 317.5 X 79.38 INCH: 7.25 X 12.5 X 3.125
WEIGHT (SINGLE UNIT)	1.2 LB (0.54 KG)
WEIGHT (KIT PACKAGED)	3.6 LBS (1.63 KG)

*SPECIFICATIONS SUBJECT TO CHANGE WITHOUT NOTICE. MASS & DIMENSIONS ARE APPROXIMATE

Introduction, Features, In the Box..... 2

Specifications..... 3

Transmitter..... 5-7

Receiver..... 8-9

RS232..... 10-11

IR..... 11-12

Audio Extraction/ARC Examples..... 12-13

Ethernet..... 14

USB Select..... 15

Commands..... 16

Troubleshooting..... 17

Maintenance, Damage Requiring Service..... 18

Support, Warranty..... 19

■ The Transmitter

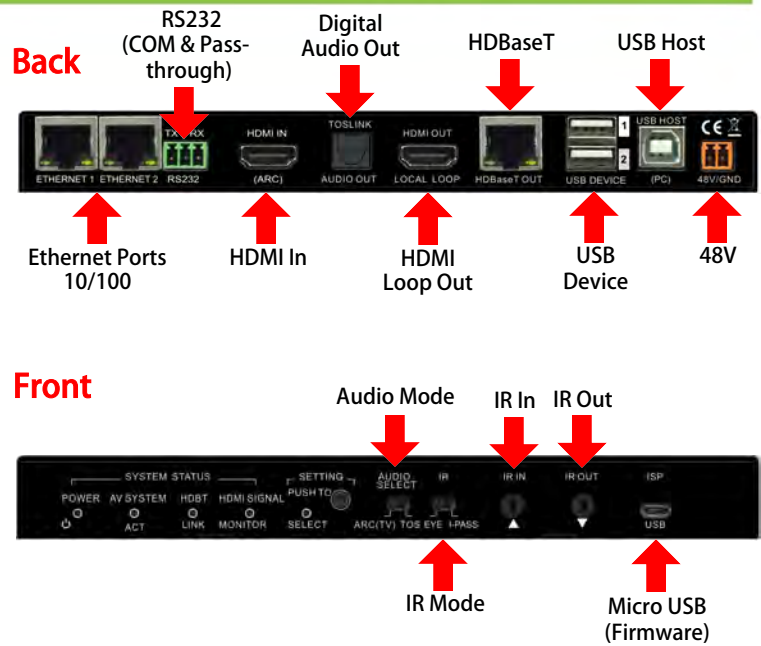
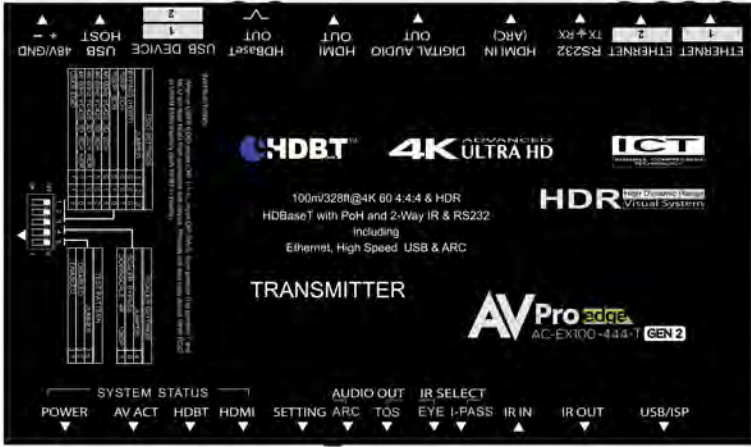

Indicator Troubleshooting Lights on the Transmitter:

POWER - On the front: (Red) This is an indicator that the power is connected.

There are only two states for light:

- Light Is On = Power supply is connected and functioning.
- Light Is Off = Power supply is not connected or there is no power present.
In order to have power: check the power supply, USP, Outlet, etc....

AV SYSTEMACT - On the front: (Blue)

This is an indicator of activity on the link - this light will blink randomly as data is sent/received

HDBaseT LINK - On the front: (Blue)

This is an indicator that that the RJ45 HDBaseT Link is stable. This light should always be SOLID

HDMI SIGNAL MONITOR - On the front: (Blue)

This indicator shows that the HDMI source is connected. This Light should always be SOLID

If the **BLUE HDMI SIGNAL MONITOR LIGHT** is OFF, check the following:

1. The source. Plug it directly into the display to be sure it's functioning properly
2. Try a longer HDMI cable. Some HDMI cables do not sync well at shorter lengths
3. Set the EDID to state #1 (See below)
4. Contact AVProEdge if these suggestions do not work

POWER FROM Slide Switch: (On the front) This is used to select where the power is coming from.

- TX (Default)= You will need to power the TRANSMITTER, the receiver will be powered over the CAT Cable (Default).
- RX = You will need to power the RECEIVER, the transmitter will be powered over the CAT Cable from the receiver (This is called "Reverse Power").



AUDIO IN SELECT Slide Switch: (On the front) This is used to select how you want audio from the display.

There are two options

- ARC(TV) - Audio is received back from the Receiver and played on the TOSLINK port (be sure to set audio in TV if you are limited to 2CH)
- TOS - Audio is extracted from the SOURCE ONLY to the TOSLINK port



Indicator Troubleshooting Lights on the Transmitter cont:

LINK - Above RJ45 (HDBT) Port: (GREEN) This indicator shows that the AV HDBT link between the Tx and Rx is in tact. This light should ALWAYS be solid. If this light is flashing or not present attempt following:

1. Check the length. The maximum distances are 100m (330ft) on 4K and 100m (330ft) on 1080P.
2. Remove any coils of cable and make sure that there is not excess cabling.
3. Bypass all patch panels and punch-down blocks.
4. Re-terminate connectors. Sometimes, even if a cable tester indicates the run is valid, something may be slightly off.
 - a. ***Standard RJ45 ends are recommended. Pass through style types can cause interference/crosstalk**
5. Contact AVProEdge if these suggestions do not work.

STATUS- Above RJ45 (HDBT) Port: (AMBER) This is an indicator showing that the power is present between the Transmitter and Receiver. This light ALWAYS BLINKS steadily indicating everything is OK. If you do not see this light, attempt the following:

1. Check the length. The maximum distances are 100m (330ft) on 4K and 100m (330ft) on 1080P.
2. Remove any coils of cable and make sure that there is not excess cabling.
3. Bypass all patch panels and punch-down blocks.
4. Re-terminate connectors. Sometimes, even if a cable tester indicates the run is valid, something may be just slightly off.
 - a. ***Standard RJ45 ends are recommended. Pass through style types can cause interference/crosstalk**
5. Try powering from the Receiver instead of the Transmitter (See Receiver page for more about PoE direction).
6. Contact AVProEdge if these steps do not work.

Ethernet Lights & Usage:

Ethernet usage is very straight-forward. It is used for driving network communication over the HDbaseT link. The purpose of these ports is to act as a "Hub", if you plug one port into a router all the other ports on both the Tx & Rx now have access to the network.

Usage Examples:

- Supplying a hardwire Ethernet connection to video zones for on-device streaming and/or local gaming devices and players.
- Supplying server based content from a server to a remote display.
- Supplying a zone with a hardwired Ethernet connection for a Wi-Fi access-point in remote zones.

Usage is plug-&-play - the ports are always active and so long as ONE of the FOUR combined ports between the Tx and Rx is connected to the network the other three have access.

Ethernet Indicator Lights:

- **AMBER** - This indicates and Ethernet connection is made, and the connection is stable. This should be SOLID.
- **GREEN** - This indicates that there is activity on the line. This light flashes randomly as data is transmitted. If this light is steady OFF there is no data coming through or you may need to reset the Ethernet router.

▪ **Functions & Setup of the Transmitter:**

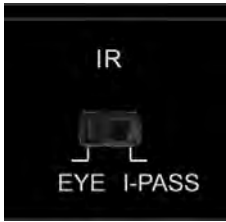

IR Mode Slide Switch: (On Front) This is used to select a preferred IR Mode - There are two modes:

- IR-EYE - The IR Input will be configured to operate with an IR Receiver Eye.
- I-PASS - The IR Input will be configured to safely operate with a direct connection from a control system using a mono or stereo 3.5mm cable. It's protected @ 3v-20v. Default mode is IR-EYE.

EDID Management:

Dip Switch Located on side of Transmitter

UP = 0 = Off
Down = 1 = On



INSTRUCTIONS:

When in USER EDID mode (DIP 1-1-1), move DIP SW-5, from position 0 to position 1 and MCU will read EDID from connected sink device. Process will also copy actual SINK EDID to USER EDID memory (with HDBT in priority).

EDID SETTINGS				
	JUMPER	1	2	3
BYPASS (HDBT)		0	0	0
1080P 2CH		0	0	1
1080P 8CH		0	1	0
4K 60Hz YC420 3D 2CH		0	1	1
4K 60Hz YC420 3D 8CH		1	0	0
4K 60Hz YC420 3D 2CH HDR		1	0	1
4K 60Hz YC420 3D 8CH HDR		1	1	0
USER EDID		1	1	1

SCALER SETTINGS			
	JUMPER		
		4	
SCALER BYPASS		0	
SCALE 4K 1080P		1	

TEST PATTERN	
JUMPER	
5	
DISABLED	0
ENABLED	1

COPY EDID Function:

- Set DIP Switches 1, 2, and 3 to the DOWN position (ON)
- While everything is powered up, set DIP Switch 5 to the DOWN position (ON). Wait a moment, then Set DIP Switch 5 back UP (OFF) to disable the TEST PATTERN. This will copy the EDID to the USER EDID memory with HDBaseT in Priority. This means the that it will copy from the display plugged into the Receiver.

Why do this?

This is commonly used when there is a need for a specific, known EDID that the installer may prefer. It can also be used if you want to bypass an EDID of an AVR or another connected device. (IE, plug the extender kit directly into a display and COPY the EDID. Plug it back into an AVR that may not have a current/good EDID).

SCALER SETTINGS:

- DIP Switch 4, UP (OFF) - The scaler is OFF
- DIP Switch 4, DOWN (ON) the incoming 4k signal will be downscaled to 1080P

TEST PATTERN:

- DIP Switch 5, UP (OFF/DISABLED) - The test pattern is off
- DIP Switch 5, DOWN (ON/ENABLED) - A 1080p test pattern is generated

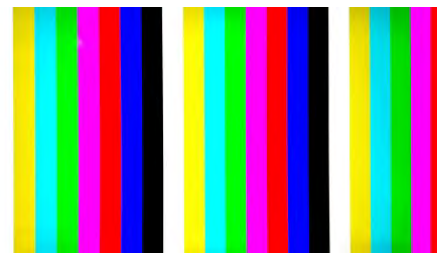

■ The Receiver

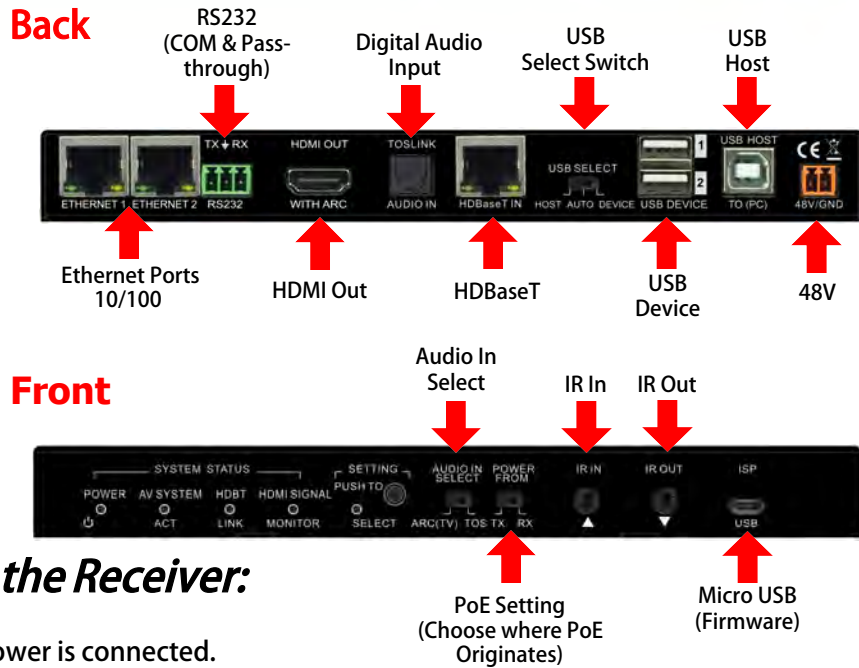

Indicator Troubleshooting Lights on the Receiver:

POWER - On the front: (Red) This is an indicator that the power is connected.

There are only two states for light:

- Light Is On = Power supply is connected and functioning
- Light Is Off = Power supply is not connected or there is no power present. In order to have power: check the power supply, USP, Outlet, etc...
- If you are powering from the Transmitter, verify the POWER FROM is set to TX

AV SYSTEMACT-Onthe front: (Blue)

This is an indicator of activity on the link - this light will blink randomly as data is sent/received

HDBaseT LINK-Onthe front: (Blue)

This is an indicator that that the RJ45 HDBaseT Link is stable. This light should always be SOLID

HDMI SIGNAL MONITOR - Onthe front: (Blue)

This indicator shows that the HDMI Display is connected. This Light should always be SOLID

If the **BLUE HDMI SIGNAL MONITOR LIGHT** is OFF, check the following:

1. Try a longer HDMI cable. Some HDMI cables do not sync well at shorter lengths
2. Try another port on the Display if possible
3. Contact AVProEdge if these suggestions do not work

- **TX (Default)**= You will need to power the TRANSMITTER, the receiver will be powered over the CAT Cable (Default).
- **RX** = You will need to power the RECEIVER, the transmitter will be powered over the CAT Cable from the receiver (This is called "Reverse Power").



AUDIO IN SELECT Slide Switch : (On the front) This is used to select how you want the extracted audio is originated from.

There are two options (you are choosing where the audio is extracted from at the Transmitter:

- **ARC(TV)** - Audio is sent back to the TRANSMITTER via the ARC HDMI port (be sure to choose ARC port and enable on display)
- **TOS** - Audio is sent back to the TRANSMITTER via the TOSLINK Port of the display (be sure to set audio type in TV if you are limited to 2CH)



Indicator Troubleshooting Lights on the Receiver cont.:

LINK - Above RJ45 (HDBT) Port: (Green) This indicator shows that the AV HDBT link between the Transmitter and Receiver is in tact. This light will ALWAYS be solid. If this light is flashing or not present do the following:

1. Check the length. The maximum distances are 70m (230ft) on 4K and 100m (330ft) on 1080P.
2. Remove any coils of cable and make sure that there is not excess cabling.
3. Bypass all patch panels and punch-down blocks.
4. Re-terminate connectors. Sometimes, even if a cable tester indicates the run is valid, something may be slightly off.
 - a. **Standard RJ45 ends are recommended. Pass through style types can cause interference/crosstalk**
5. Contact AVProEdge if these suggestions do not work.

STATUS- Above RJ45 (HDBT) Port: (Amber) This indicator shows that the power is present between the Transmitter and Receiver. This light ALWAYS BLINKS steadily indicating everything is correct. If you do not see this light, try the following:

1. Check the length. The maximum distances are 70m (230ft) on 4K and 100m (330ft) on 1080P.
2. Remove any coils of cable and make sure that there is not excess cabling.
3. Bypass all patch panels and punch-down blocks.
4. Re-terminate connectors. Sometimes, even if a cable tester indicates the run is valid, something may be slightly off.
 - a. **Standard RJ45 ends are recommended. Pass through style types can cause interference/crosstalk**
5. Try powering from the Receiver instead of the Transmitter (See Receiver page for more about PoE direction).
6. Contact AVProEdge if these suggestions do not work.

Ethernet Lights & Usage:

Ethernet usage is very straight-forward. It is used for driving network communication over the HDBaseT link. The purpose of these ports is to act as a "hub", if you plug one port into a router all the other ports on both the Tx & Rx now have access to the network.

Usage Examples:

- Supplying a hardwire Ethernet connection to video zones for on-device streaming and/or local gaming devices and players.
- Supplying server based content from a server to a remote display.
- Supplying a zone with a hardwired Ethernet connection for a Wi-Fi access-point in remote zones.

Usage is plug-&-play - the ports are always active and as long as ONE of the FOUR combined ports between the Tx and Rx is connected to the network the other three have access.

Ethernet Indicator Lights:

- **AMBER** - This indicates an Ethernet connection is made, and the connection is stable. This should be SOLID.
- **GREEN** - This indicates that there is activity on the line. This light flashes randomly as data is transmitted. If this light is steady OFF there is no data coming through or you may need to reset the Ethernet router.

■ RS-232 Configuration

RS-232 can be used to pass control signals bi-directionally to & from any RS-232 compatible device. This is commonly

1. Control System --> Display/Projector (ie, Power On/Off)
2. Display/Projector --> Control System (ie, Display Status, Volume Status etc...)
3. When ultra long-range serial communication is needed (think concerts, live events). Use the extender.

The unit comes with 3 pin connectors to allow for any wire an integrator would like. The pin out configuration Left=TX, Center=Ground, Right=RX and looks like this:

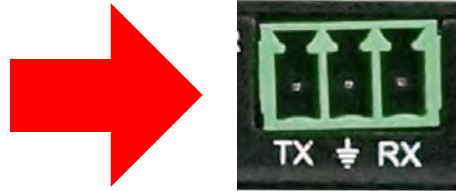

This is how the cable should look. If using the AC-CABLE-3.5-DB9F (Female) or AC-CABLE-3.5-DB9M (Male), the colors will be the same. With any other cable, please follow Tx, G, Rx as shown below. See RS-232 cable preparation diagram below



RS-232 CABLE FOR AVPRO EDGE

IN ORDER TO CONNECT YOUR COMPUTER TO THE SWITCH BY RS-232 YOU NEED TO MAKE YOUR OWN CABLE WITH ONE END A PHOENIX CONNECTOR AND THE OTHER END A RS-232 PORT. YOUR COMPUTER DOESN'T HAVE A RS-232 INPUT, GET A USB CONVERTER (AS SHOWN BELOW), AND PLUG THE USB END TO ANY COMPUTER

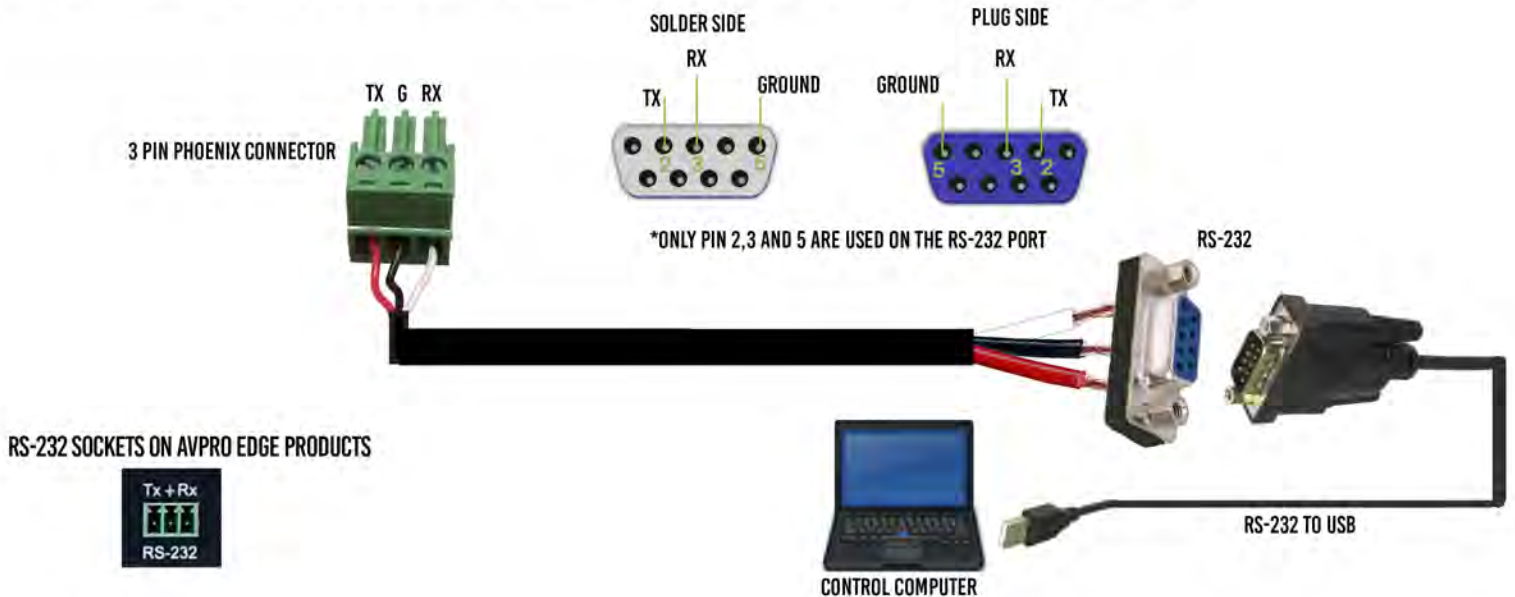

RS-232 SOCKETS ON AVPRO EDGE PRODUCTS



■ *RS-232 Sample Application*

444 EXTENDER RS-232 CONTROL

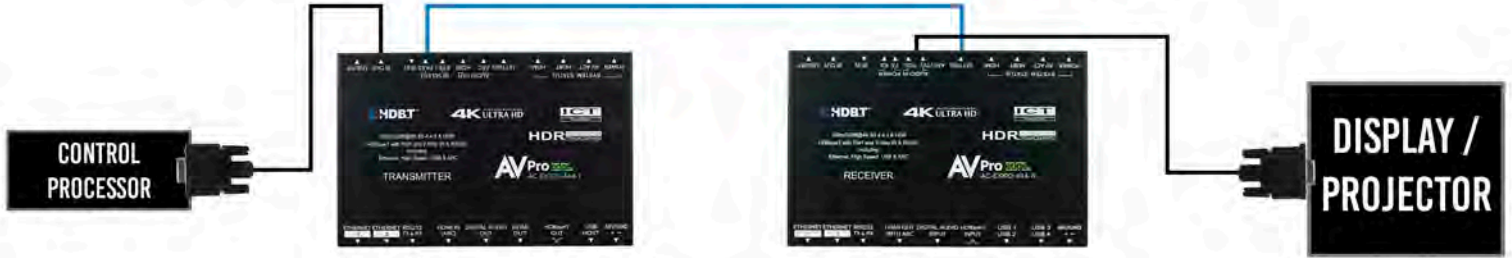

RS-232 CONTROL IS BI-DIRECTIONAL SO YOU ARE ABLE TO RECEIVE FEEDBACK

■ *IR Configuration*

IR can be used in three ways:

From Rack (Control System Direct): Plug a MONO 3.5mm cable into an emitter port of any control system directly into the "IR IN" port on the AC-EX40-444 Transmitter to pass IR signals directly to the remote end. NOTE - Be sure the IR MODE Slide Switch is set to "I-PASS" on the Transmitter

From Rack (Using IR-EYE): Plug an IR-Receiver Eye into the "IR IN" of the AC-EX40-444 Transmitter in order to pass infrared signals generated from a device or IR Remote. NOTE - Be sure the IR MODE Slide Switch is set to "IR-EYE" on the Transmitter.

From Remote End: Use an IR-Receiver Eye on the AC-EX40-444 Receiver (IR In Port) in order to send IR signals BACK to the rack and out of the TRANSMITTER IR Out Port with an emitter.

444 EXTENDER I-PASS IR CONTROL



444 EXTENDER IR CONTROL



■ **IR INPUT to AC-EX100-444-GEN2-T (Transmitter) has two options**

Set to the left, "EYE" Mode to use an IR Receiving Eye



Set to the right, "I-PASS" to connect directly to a control system

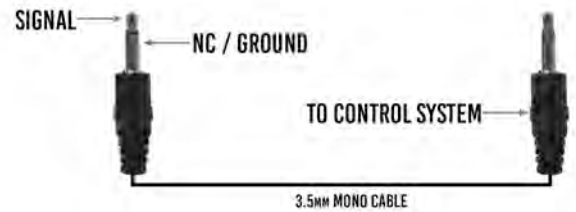

■ **IR OUTPUT (TX & RX)**

IR OUT Emitter (Non-Flashing)



■ **IR INPUT (RX)**

IR IN w/ Receiver Eye



■ **Audio Extraction on AC-EX100-444-GEN2-T TOSLINK Port**

This feature extracts up to 8ch Audio from the source device in order to be run to a separate amplifier or AVR. Both the Transmitter and Receiver have "AUDIO SELECT" toggle switch that need to be set depending on how your INPUTING/ EXTRACTING audio.

*NOTE: You can extract audio at the Transmitter via the TOSLINK port. The source of the audio can either be HDMI (ARC), or you can input via the TOSLINK port on the Receiver (see examples below and on the next page).

4K60 100M EXTENDER AUDIO EXTRACTION



ARC - Audio Return Channel Setup

The Audio Return Channel (ARC) in HDMI 1.4 and 2.0 enables a TV, via a single HDMI cable or Toslink, to send audio data "upstream" to an A/V receiver or surround audio controller, our extender will continue the upstream audio all the way to the Transmitter. There it can be connected via HDMI ARC or Toslink.



NOTE: Both connected devices must support ARC. Make sure the port you are plugging into is labeled ARC. Some devices may require the ARC function to be enabled. It is best to check that devices user manual to verify the ARC function is ON/ENABLED.



■ Using Ethernet:

Ethernet usage is very straight-forward. It is used for driving network communication over the HDBaseT link. This of these ports as a "hub", if you plug one port into a router all the other ports on both the Tx & Rx now have access to the network.

Usage Examples:

- Supplying a hardwire Ethernet connection to video zones for on-device streaming and/or local gaming devices and players.
- Supplying server based content from a server to a remote display.
- Supplying a zone with a hardwired Ethernet connection for a WiFi access-point in remote zones.

Usage is plug-&-play - the ports are always active and so long as ONE of the FOUR combined ports between the Tx and Rx is connected to the network the other three have access.

Ethernet Indicator Lights:

- **AMBER** - This indicates and Ethernet connection is made, and the connection is stable. This should be SOLID.
- **GREEN** - This indicates that there is activity on the line. This light flashes randomly as data is transmitted. If this light is steady OFF there is no data coming through or you may need to reset the Ethernet router.

Usage Diagram:



▪ **USB SELECT Switch on Receiver**

There are 3 options to select on the Receiver

- HOST - Select this if you are plugging the Host Device into the Receiver
- AUTO - Default, will automatically detect what port you are using. Issues, try selecting HOST or DEVICE
- DEVICE - Select this if you are plugging the Host Device into the Transmitter

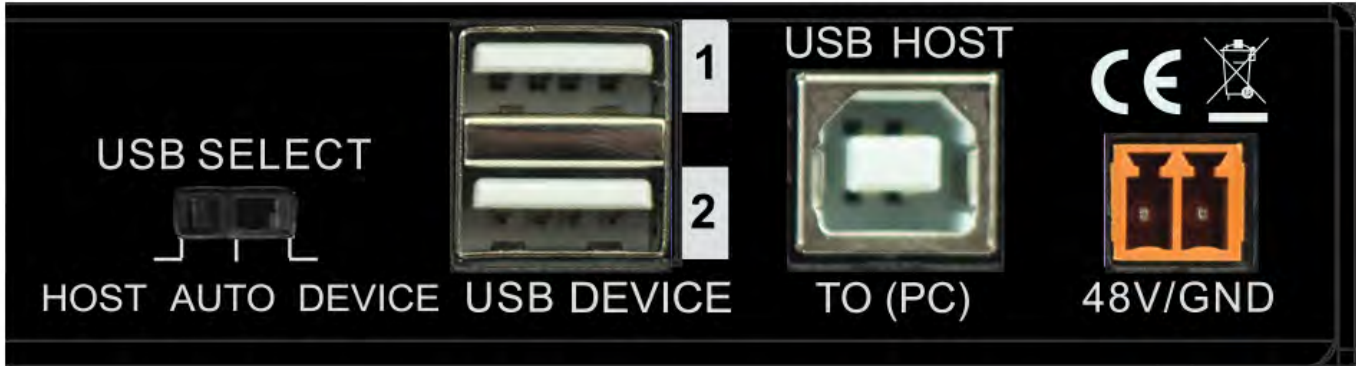

BI-DIRECTIONAL USB EXTENSION

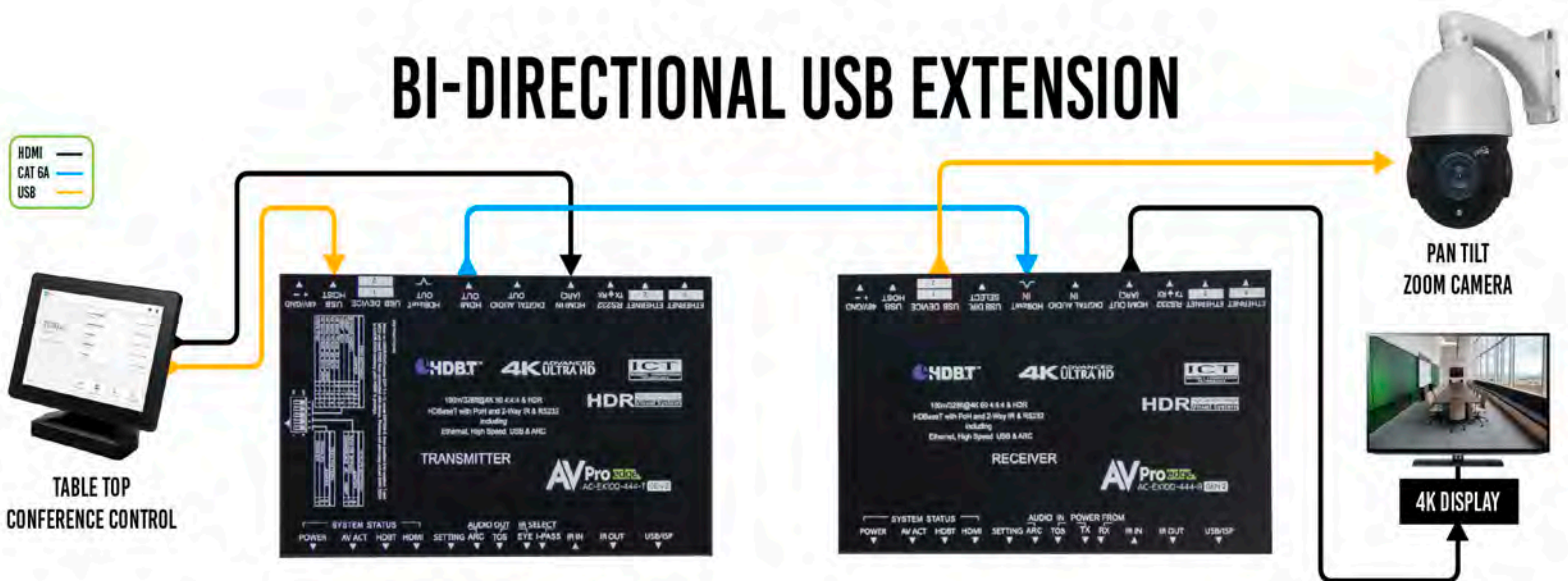

=				=	
=	H	:	Help	=	
=	STA	:	Show Global System Status	=	
=	SET RST	:	Reset to Factory Defaults	=	
=	SET ADDR xx	:	Set System Address to xx {xx=[00-99](00=Single)}	=	
=	GET ADDR	:	Get System Address	=	
=	GET STA	:	Get System Status	=	
=	GET IN SIG STA	:	Get Input Signal Status	=	
=				=	
=	Output Setup Commands:			=	
=	SET OUT1 HP VIDEOy	:	Set HDMI Output VIDEO Mode{y=[1,3](1=BYPASS,3=2K->4K)}	=	
=	SET OUT1 TP VIDEOy	:	Set HDBT Output VIDEO Mode{y=[2,5](2=4K->2K,5=ICT Mode)}	=	
=	SET OUT1 EXA EN/DIS	:	Set Ex-Audio Output Enable/Disable	=	
=	SET OUT1 HP SGM EN/DIS	:	Set HDMI Output Signal Generator Enable/Disable	=	
=	SET OUT1 TP SGM EN/DIS	:	Set HDBT Output Signal Generator Enable/Disable	=	
=	SET OUT1 HP STREAM ON/OFF	:	Set HDMI Output Stream ON/OFF	=	
=	SET OUT1 TP STREAM ON/OFF	:	Set HDBT Output Stream ON/OFF	=	
=	GET OUT1 HP VIDEO	:	Get HDMI Output Video Mode	=	
=	GET OUT1 TP VIDEO	:	Get HDBT Output Video Mode	=	
=	GET OUT1 HP EDID DATA	:	Get HDMI Output EDID DATA	=	
=	GET OUT1 TP EDID DATA	:	Get HDBT Output EDID DATA	=	
=	GET OUT1 EXA	:	Get Ex-Audio Output Enable/Disable Status	=	
=	GET OUT1 HP SGM	:	Get HDMI Output Signal Generator Enable/Disable Status	=	
=	GET OUT1 TP SGM	:	Get HDBT Output Signal Generator Enable/Disable Status	=	
=	GET OUT1 HP STREAM	:	Get HDMI Output Stream ON/OFF Status	=	
=	GET OUT1 TP STREAM	:	Get HDBT Output Stream ON/OFF Status	=	
=				=	
=	Input Setup Commands:			=	
=	SET IN1 EDID y	:	Set Input 1 EDID{y=[0~7]}	=	
=				=	
=	0:EDID_BYPASS		1:1080P_2CH	2:1080P_8CH	=
=	3:4K60HzY420_3D_2CH		4:4K60HzY420_3D_8CH	5:4K60HZ_3D_2CH_HDR	=
=	6:4K60HZ_3D_8CH_HDR		7:User_EDID		=
=					=
=	SET IN1 EDID CY OUT1 HP	:	Copy HDMI Output EDID To Input1(USER1 BUF)	=	
=	SET IN1 EDID CY OUT1 TP	:	Copy HDBT Output EDID To Input1(USER1 BUF)	=	
=	SET IN1 EDID U1 DATAz	:	Write EDID To User Buffer of Input1{z=[EDID Data]}	=	
=	GET IN1 EDID	:	Get Input1 EDID Index	=	
=	GET IN1 EDID y DATA	:	Get Input1 EDID y Data{y=[1~7]}	=	
=				=	

■ *Troubleshooting*

- Verify Power - Pg.5 & 8
 - Verify POE Switch is correct - Pg.10
- Verify Connections - Check that all cables are properly connected
 - TX Indicator Troubleshooting Lights - Pg. 5-6
 - RX Indicator Troubleshooting Lights - Pg. 8-9
- Not passing video, this may be an EDID issue. Out of the box the default is EDID BYPASS. Try a canned EDID or copy the connected displays EDID - Pg. 7
- Use DIP Switch 5 and turn on the built in 1080p Test Pattern to verify connection from the Transmitter to the Display - Pg. 7
- IR Issues - Verify correct connections - P. 12-13
 - Visibly flashing Emitters may not function properly, try the IR Cables that come in the box if you are experiencing issues
- Extracted Audio Issues - Pg. 13-14
 - Verify Source is set to output 8ch if using TOSLINK
 - *Note: This unit does NOT downmix*
- USB Issues - Pg. 16
 - Verify the USB SELECT switch is correct
- Still having issues, contact us
 - Support Direct - +1-605-977-3477
 - All inquiries - + 1-605-274-6055
 - Submit a support request ticket
 - <https://support.avproedge.com/hc/en-us/requests/new>

▪ Maintenance

To ensure reliable operation of this product as well as protecting the safety of any person using or handling this device while powered, please observe the following instructions.

- Use the power supplies provided. If an alternate supply is required, check voltage, polarity and that it has sufficient power to supply the device it is connected to.
- Do not operate these products outside the specified temperature and humidity range given in the above specifications.
- Ensure there is adequate ventilation to allow this product to operate efficiently.
- Repair of the equipment should only be carried out by qualified professionals as these products contain sensitive components that may be damaged by any mistreatment.
- Only use this product in a dry environment. Do not allow any liquids or harmful chemicals to come into contact with these products.
- Clean this unit with a soft, dry cloth. Never use alcohol, paint thinner or benzene to clean this unit.

▪ Damage Requiring Service

The unit should be serviced by qualified service personnel if:

- The DC power supply cord or AC adaptor has been damaged
- Objects or liquids have gotten into the unit
- The unit has been exposed to rain
- The unit does not operate normally or exhibits a marked change in performance
- The unit has been dropped or the housing damaged

▪ Support

Should you experience any problems while using this product, first, refer to the Troubleshooting section of this manual before contacting Technical Support. When calling, the following information should be provided:

- Product name and model number
- Product serial number
- Details of the issue and any conditions under which the issue is occurring

▪ Warranty

If your product does not work properly because of a defect in materials or workmanship, AVProEdge (referred to as “the warrantor”) will, for the length of the period indicated as below, (Parts/Labor (10) Years), which starts with the date of original purchase (“Limited Warranty period”), at its option either (a) repair your product with new or refurbished parts, or (b) replace it with a new or a refurbished product. The decision to repair or replace will be made by the warrantor. During the “Labor” Limited Warranty period there will be no charge for labor. During the “Parts” warranty period, there will be no charge for parts. You must mail-in your product during the warranty period. This Limited Warranty is extended only to the original purchaser and only covers product purchased as new. A purchase receipt or other proof of original purchase date is required for Limited Warranty service.

This warranty extends to products purchased directly from AVPro or an authorized dealer. AVPro is not liable to honor this warranty if the product has been used in any application other than that for which it was intended, has been subjected to misuse, accidental damage, modification or improper installation procedures, unauthorized repairs or is outside of the warranty period. Please direct any questions or issues you may have to your local dealer before contacting AVPro.

Thank you for choosing AVProEdge!

Please contact us with any questions, we are happily at your service!



AVProEdge
2222 E 52nd St N ~ Sioux Falls, SD 57104

1-877-886-5112 ~ 605-274-6055
support@avproedge.com