

SONY®

Sound Bar

Operating Instructions

HT-A3000

IMPORTANT – Read the End User Software License Agreement before using your Sony product. Using your product indicates your acceptance of the End User Software License Agreement. The software license agreement between you and Sony is available at the following URL: https://rd1.sony.net/help/vs/el22/h_zz/

WARNING

Do not install the speaker system in a confined space, such as a bookcase or built-in cabinet.

To reduce the risk of fire, do not cover the ventilation opening of the speaker system with newspapers, tablecloths, curtains, etc.

Do not expose the speaker system to naked flame sources (for example, lighted candles).

To reduce the risk of fire or electric shock, do not expose this speaker system to dripping or splashing, and do not place objects filled with liquids, such as vases, on the speaker system.

The speaker system is not disconnected from the mains as long as it is connected to the AC outlet, even if the speaker system itself has been turned off.

As the mains plug is used to disconnect the speaker system from the mains, connect the speaker system to an easily accessible AC outlet. Should you notice an abnormality in the speaker system, disconnect the mains plug from the AC outlet immediately.

CAUTION

Risk of explosion if the battery is replaced by an incorrect type.

Do not expose batteries or appliances with battery-installed to excessive heat, such as sunshine and fire.

Do not place this product close to medical devices.

This product (including accessories) has magnet(s) which may interfere with pacemakers, programmable shunt valves for hydrocephalus treatment, or other medical devices. Do not place this product close to persons who use such medical devices. Consult your doctor before using this product if you use any such medical device.

When connecting the speaker system to the Internet, use the router (ADSL modem or optical line termination device with the router function supplied with the Internet provider, or Wi-Fi access point). If you connect to the Internet without using the router, a security problem may occur. If you are not sure that the wall outlet for the network line has the router function, ask your manager of the apartment house or Internet provider.

Indoor use only.

Reduction in the Use of Hazardous Substances in Electrical & Electronic Equipment (Applicable in Republic of India)

This product and its components, consumables, parts or spares comply with the hazardous substances restriction of India's E-Waste (Management) Rules. The maximum allowable concentrations of the restricted substances are 0.1% by weight in homogenous materials for Lead, Mercury, Hexavalent Chromium, Polybrominated Biphenyls (PBB) and Polybrominated Diphenyl Ethers (PBDE), and 0.01% by weight in homogenous materials for Cadmium, except for the exemptions specified in Schedule II of the aforesaid Rules.

Recommended cables

Properly shielded and grounded cables and connectors must be used for connection to host computers and/or peripherals.

For the bar speaker

The nameplate is located on the bottom of the bar speaker.

This equipment has been tested and found to comply with the limits set out in the EMC regulation using a connection cable shorter than 3 meters.

For customers in Europe

Notice for customers: the following information is only applicable to equipment sold in countries applying EU directives and/or UK applying relevant statutory requirements

This product has been manufactured by or on behalf of Sony Corporation.

EU and UK Importer: Sony Europe B.V.

Inquiries to the EU Importer or related to product compliance in Europe should be sent to the manufacturer's authorized representative, Sony Belgium, bijkantoor van Sony Europe B.V., Da Vincilaan 7-D1, 1930 Zaventem, Belgium.

sony.com/country

Inquiries to the UK Importer or related to product compliance in the UK should be sent to the manufacturer's authorized representative, Sony Europe B.V., The Heights, Brooklands, Weybridge, Surrey KT13 0XW, United Kingdom.



Hereby, Sony Corporation declares that this equipment is in compliance with Directive 2014/53/EU.

The full text of the EU declaration of conformity is available at the following internet address:

<https://compliance.sony.eu>

Hereby, Sony Corporation declares that this equipment is in compliance with the UK relevant statutory requirements.

The full text of the declaration of conformity is available at the following internet address:

<https://compliance.sony.co.uk>

For this radio equipment, the following restrictions on putting into service or of requirements for authorisation of use apply in BE, BG, CZ, DK, DE, EE, IE, EL, ES, FR, HR, IT, CY, LV, LT, LU, HU, MT, NL, AT, PL, PT, RO, SI, SK, FI, SE, UK, UK(NI), IS, LI, NO, CH, AL, BA, MK, MD, RS, ME, XK, TR: 5150 - 5350 MHz band is restricted to indoor operations only.

This radio equipment is intended to be used with the approved version(s) of software that are indicated in the Declaration of Conformity. The software loaded on this radio equipment is verified to comply with the essential requirements of the Radio Equipment Regulations.

The software version can be found by selecting [System Information] under  [Setup] - [Advanced Settings] - [System Settings].

Internet Connection and IP address

Technical data such as IP address (or device details) is used when this product is connected to the internet for software update or receiving third party services. For software updates, these technical data may be communicated to our update servers in order to provide you with the software update appropriate to your device. If you do not want such technical data be used at all, do not set-up the wireless internet function.



Disposal of waste batteries and electrical and electronic equipment (applicable in the European Union

and other countries with separate collection systems)

This symbol on the product, the battery or on the packaging indicates that the product and the battery shall not be treated as household waste. On certain batteries this symbol might be used in combination with a chemical symbol. The chemical symbol for lead (Pb) is added if the battery contains more than 0.004% lead. By ensuring that these products and batteries are disposed of correctly, you will help to prevent potentially negative consequences for the environment and human health which could be caused by inappropriate waste handling. The recycling of the materials will help to conserve natural resources. In case of products that for safety, performance or data integrity reasons require a permanent connection with an incorporated battery, this battery should be replaced by qualified service staff only. To ensure that the battery and the electrical and electronic equipment will be treated properly, hand over these products at end-of-life to the appropriate collection point for the recycling of electrical and electronic equipment. For all other batteries, please view the section on how to remove the battery from the product safely. Hand the battery over to the appropriate collection point for the recycling of waste batteries. For more detailed information about recycling of this product or battery, please contact your local Civic Office, your household waste disposal service or the shop where you purchased the product or battery.

This equipment should be installed and operated keeping the radiator over 20 cm away from person's body.

For customers in India



Disposal of old electrical & electronic equipment (applicable in the European Union and other countries with separate collection systems)

collection systems)

To turn the wireless LAN function on/off

Press HOME on the remote control, select  [Setup] - [Advanced Settings] - [Network Settings] - [Wi-Fi Connection], and then select [On] to turn on the wireless LAN function or [Off] to turn it off.

Table of Contents

About Manuals of the Speaker System	7
---	---

What's in the Box	➔ Startup Guide (separate document)
-------------------	-------------------------------------

What You Can Do with the Speaker System	8
Guide to Parts and Controls	10
Using the Home Menu	14

Setting Up

Installing the Speaker System	15
Connecting to a TV	17
When Your TV Has the S-CENTER SPEAKER IN Jack	18
Connecting to the AC Outlet (mains)	19
Performing Initial Settings	20
Connecting the Optional Speaker	21

Watching Images

Watching TV	23
-------------------	----

Listening to Music/Sound

Listening to Sony TV Sound with the BLUETOOTH® Function	24
Listening to Music/Sound with the BLUETOOTH Function	26
Listening to Music on a USB Device	28
Listening to Sound of the Connected TV or Device Using Headphones	29

Listening to Music by

Connecting to a Network

What You Can Do by Connecting the Speaker System to a Network	31
---	----

Adjusting the Volume and Sound Quality

Adjusting the Volume	33
Enjoying Surround Effect (SOUND FIELD)	34
Making Dialogs Clearer (VOICE)	35
Enjoying Clear Sound with Low Volume at Midnight (NIGHT)	35
Adjusting the Delay Between the Picture and Sound	36
Enjoying Multiplex Broadcast Sound (AUDIO)	36
Adjusting the Dialog Volume While the DTS:X Content is Played Back	37

Using the Speaker System by Interlocking with a TV

Operating the Speaker System by Interlocking with a TV (Control for HDMI Function)	38
Operating the Speaker System by Interlocking with a TV Compatible with the "BRAVIA" Sync Function	39

Changing the Settings

Changing the Brightness of the Front Panel Display and Indicators (DIMMER)	40
Saving Power in Standby Mode	40
Entering the Network Standby Mode or Standby Mode Automatically	41
Performing Easy Setup	41
Performing Advanced Settings	42
Updating the Software	43

Troubleshooting

Troubleshooting	45
Resetting the Speaker System	52

Additional Information

Specifications	53
Radio Frequency Bands and Maximum Output Power	55
Playable Types of Audio Files	56
Supported Input Audio Formats	57
On BLUETOOTH Communication	58
Precautions	59
Copyrights and Trademarks	60
Index	62

About Manuals of the Speaker System

The information included in each manual is as shown below.

Startup Guide



Introduces the initial procedures concerning installation and connection for using the speaker system, and operations until you play music.

Operating Instructions (this document)



Explains the basic operations.

- Connection with a TV
- Playback for music/sound of devices connected with an HDMI cable or the BLUETOOTH function
- Sound adjustment, etc.

Help Guide (Web manual)

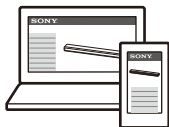

For customers in Americas

https://rd1.sony.net/help/ht/a3000/h_uc/



For customers in other countries/
regions

https://rd1.sony.net/help/ht/a3000/h_zz/



Provides all operations including advanced usage.

- Playback for music/sound with the network function
- Details on menu items, etc.

Tips

- The instructions in these manuals describe operations using the controls on the remote control.
You can use the buttons on the bar speaker if they have the same or similar names as those on the remote control.
- Characters in brackets [] appear on the TV screen or front panel display.
- Details are omitted from the illustrations.

What's in the Box

Refer to Startup Guide (separate document).

What You Can Do with the Speaker System

The speaker system supports object-based audio formats such as Dolby Atmos and DTS:X.

TV

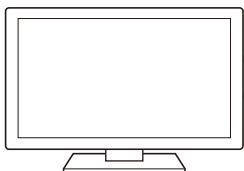

- "Watching TV" (page 23)
- "Listening to Sony TV Sound with the BLUETOOTH® Function" (page 24)



Blu-ray Disc™ player, set-top box, gaming console, etc.

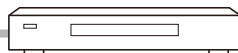

USB device



"Listening to Music on a USB Device" (page 28)

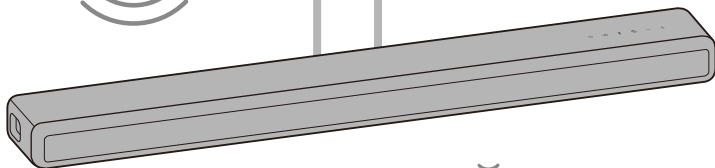

Mobile device

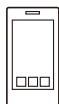
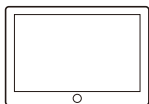

"Listening to Music/Sound with the BLUETOOTH Function" (page 26)



Headphones



"Listening to Sound of the Connected TV or Device Using Headphones" (page 29)

Network

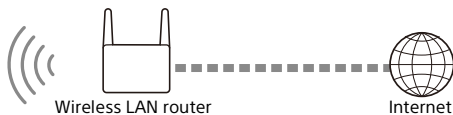

"What You Can Do by Connecting the Speaker System to a Network"
(page 31)

For the connecting method to the network and functions enabled with the network connection, refer to Help Guide (Web manual).

For customers in Americas

https://rd1.sony.net/help/ht/a3000/h_uc/



For customers in other countries/regions

https://rd1.sony.net/help/ht/a3000/h_zz/



Optional speakers

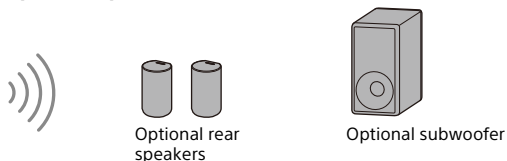

For the operations of the optional rear speakers and subwoofer, refer to their operating instructions.
For the supported optional speakers, confirm on the Sony website.

Guide to Parts and Controls

Bar Speaker

Front

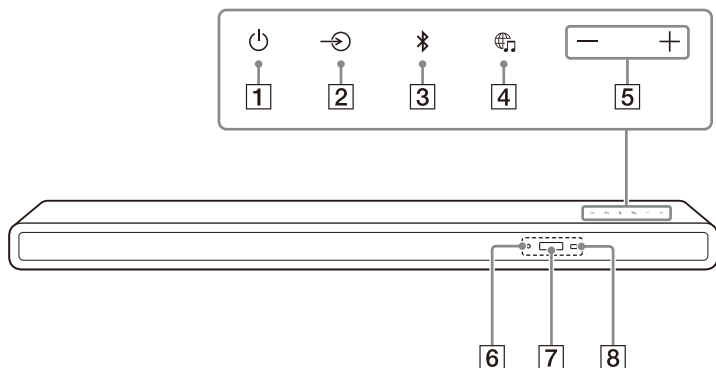

1 **⏻ (power) button**

Turns on the speaker system or sets it to standby mode.

2 **↻ (input select) button**

Selects the input for playback on the speaker system.

3 **📶 (BLUETOOTH) button** (page 24)

4 **🌐 (MUSIC SERVICE) button**

If you have previously played music on Spotify on the speaker system, you can resume playback by pressing this button. This button may not be available in some countries/regions.

5 **+/- (volume) buttons**

6 **BLUETOOTH indicator**

- Flashes quickly in blue: In the waiting status for BLUETOOTH pairing
- Flashes in blue: BLUETOOTH connection is being attempted.
- Lights in blue: BLUETOOTH connection has been established.

7 **Front panel display**

8 **Remote control sensor**

Point the remote control at the remote control sensor to operate the speaker system.

Rear

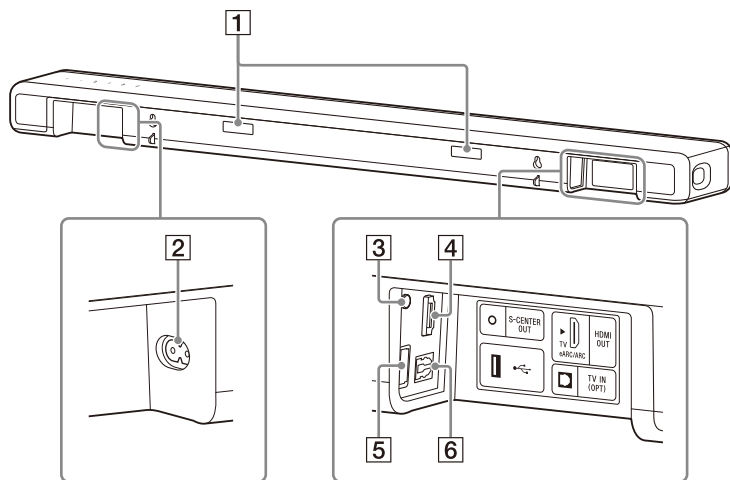

1 IR repeater

Transmits the remote signal of the TV remote control to the TV.

2 AC inlet

3 S-CENTER OUT jack (page 18)

4 HDMI OUT (TV eARC/ARC) jack

Connect a TV that has an HDMI input jack with an HDMI cable. The speaker system is compatible with eARC and ARC. ARC is the function that sends TV sound to an AV device such as the speaker system from the TV's HDMI jack. eARC is an extension of ARC and enables transmission of the object audio and multi-channel LPCM content that cannot be transmitted with ARC.

5 USB (USB) port (page 28)

6 TV IN (OPT) jack

Remote Control

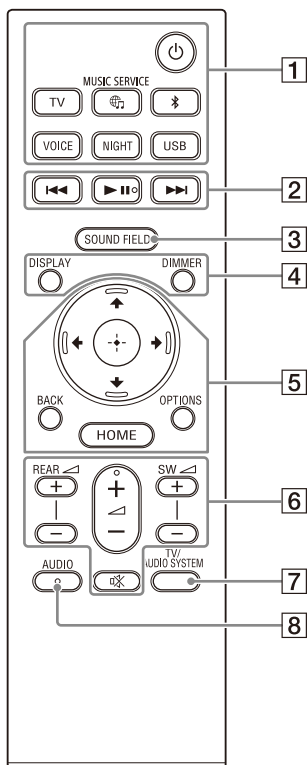

1 (power)

Turns on the speaker system or sets it to standby mode.

TV (page 23)

(MUSIC SERVICE)

If you have previously played music on Spotify on the speaker system, you can resume playback by pressing this button.

This button may not be available in some countries/regions.

(BLUETOOTH) (page 26)

VOICE (page 35)

NIGHT (page 35)

USB (page 28)

2 Playback operation buttons

(previous/next)

Selects the previous/next track or file.

Pressing and holding it searches backward or forward (rewind/fast forward) during playback.

* (play/pause)*

Starts, pauses, or re-starts playback (resume play).

3 SOUND FIELD (page 34)

4 DISPLAY

Displays stream information in the front panel display.

DIMMER (page 40)

5 ↑/↓/←/→ (up/down/left/right)
(page 14)

⊕ (enter) (page 14)

BACK (page 14)

OPTIONS (page 37)

Displays the options menu in the front panel display.

HOME (page 14)

6 REAR ◀ (rear speakers volume)
+/-

Adjusts the volume of the optional rear speakers when connecting them.

◀ (volume) +/-

Adjusts the volume.

SW ◀ (subwoofer volume) +/-

Adjusts the volume of the built-in subwoofer or optional subwoofer when connecting it.

⊗ (muting)

Turns off the sound temporarily.

7 TV/AUDIO SYSTEM

Switches the output for the connected TV sound between the TV and speaker system.

Note

This button works in the following conditions.

- The connected TV is compatible with the System Audio Control function.
- The Control for HDMI function of the speaker system is set to on (page 38).

8 AUDIO* (page 36)

* The AUDIO, ▶|| (play/pause), and ◀ (volume) + buttons have a tactile dot. Use it as a guide during operation.

About the replacement of batteries for the remote control

When the speaker system does not respond by operating with the remote

control, replace two batteries with new batteries.

Use R03 or LR03 (size AAA) batteries for replacement.

Using the Home Menu

You can display the home menu on the TV screen by connecting the speaker system and TV with an HDMI cable.

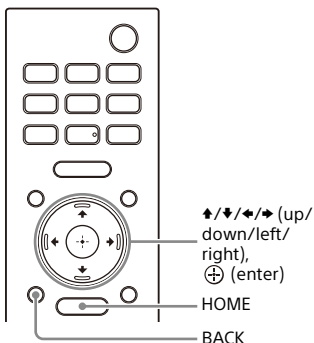

- 3** Press $\uparrow/\downarrow/\leftarrow/\rightarrow$ (up/down/left/right) to select the item that you want, then press \oplus (enter).



The selected input or setting display appears on the TV screen. To return to the previous screen, press BACK.

- 1** Press HOME.

The home menu appears on the TV screen.

- 2** Press $\uparrow/\leftarrow/\rightarrow$ (up/left/right) to select the category that you want, then press \downarrow (down) or \oplus (enter).

The items for the selected category appear under the category list on the TV screen.

Category	Explanation
 [Watch & Listen]	Selects the input of the TV or audio device that is connected to the speaker system or music service for playing back on the speaker system.
 [Setup]	Performs the basic initial settings by using [Easy Setup] or various advanced settings of the speaker system.

Setting Up

Installing the Speaker System

Installing the Bar Speaker

For the installation, refer to Startup Guide (separate document).

Mounting the Bar Speaker on a Wall

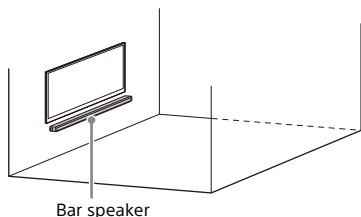

Notes

- Prepare screws (not supplied) that are suitable for the wall material and stability. Depending on the wall material, the wall may be damaged.
- Fasten the screws securely in the wall beam.
- Hang the bar speaker horizontally on the reinforced wall.
- Have the installation done by a Sony dealer or licensed contractor and pay special attention to safety during the installation.
- Sony shall not be held responsible for accidents or damage caused by improper installation, insufficient wall stability, improper screw installation, natural disasters, etc.
- Two or more persons are required to hang the bar speaker for safety.

- 1 Prepare two screws (not supplied) that are suitable for the wall mount holes on the rear of the bar speaker.

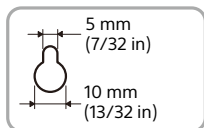
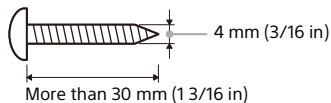

Hole on the rear of the bar speaker

- 2 Align the vertical line above the "↑ ① TV CENTER LINE" printed on the WALL MOUNT TEMPLATE (supplied) with the center of the width of your TV.

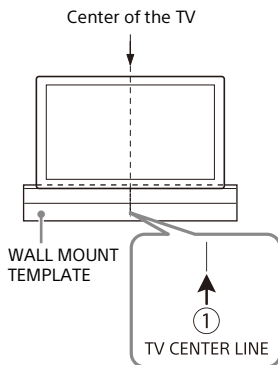

- 3** Align the “← ② TV BOTTOM LINE” printed on the WALL MOUNT TEMPLATE with the bottom of your TV, then adhere the WALL MOUNT TEMPLATE on the wall with a commercially available adhesive tape, etc.

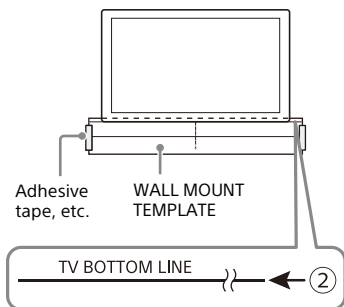

- 4** Fasten the screws prepared in step 1 securely into the screw marks on the “← ③ SCREW LINE” printed on the WALL MOUNT TEMPLATE.

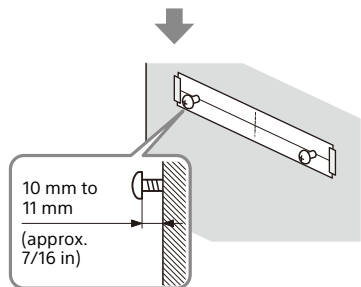
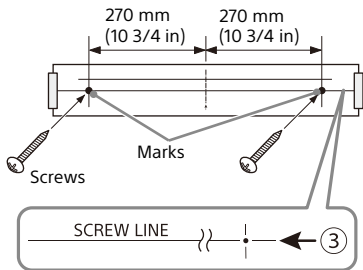

- 5** Remove the WALL MOUNT TEMPLATE.

- 6** Hang the bar speaker on the screws.

Align the holes of the rear of the bar speaker with the screws, then hang the bar speaker on the two screws.

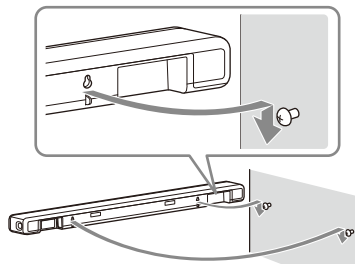

Notes

- When adhering the WALL MOUNT TEMPLATE on the wall, smooth it out fully.
- Install the bar speaker apart from the TV by 70 mm (2 7/8 in) or more.

Installing the Optional Speakers

Refer to the operating instructions of the optional speakers.

Connecting to a TV

Connecting a TV Compatible with ARC/eARC

- 1 Connect the HDMI IN jack compatible with ARC/eARC on the TV and HDMI OUT (TV eARC/ARC) jack on the speaker system with the HDMI cable (supplied).

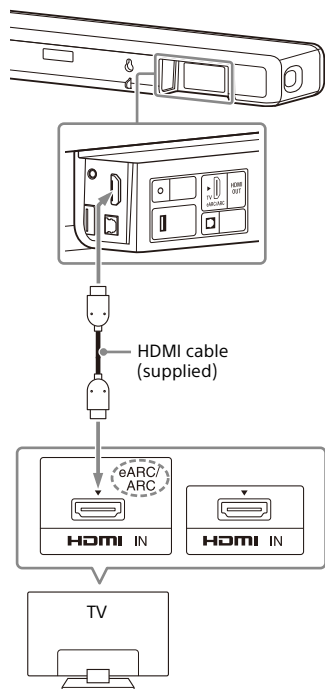

Notes

- Make sure that the connectors are firmly inserted.
- Enable the Control for HDMI function on the TV. If the Control for HDMI function on the TV is not enabled, TV sound will not be output from the speaker system.

Connecting a TV That Is not Compatible with ARC/eARC

- 1 Connect the HDMI IN jack on the TV and HDMI OUT (TV eARC/ARC) jack on the speaker system with the HDMI cable (supplied).

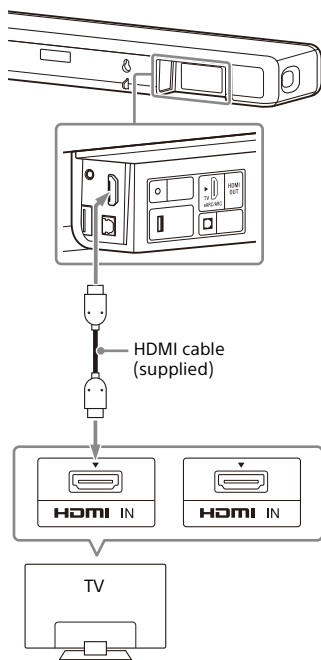

- 2** Connect the optical digital output jack on the TV and the TV IN (OPT) jack on the speaker system with an optical digital cable (not supplied).

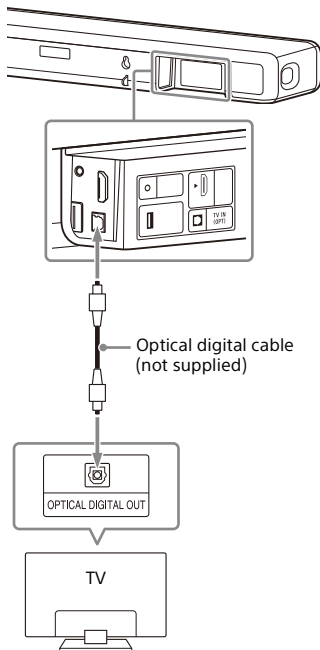

Notes

- Make sure that the connectors are firmly inserted.
- Insert a plug of the optical digital cable in the correct direction by checking the shape of the plug and connector on the bar speaker and TV. If the plug is forcibly inserted in the wrong direction, the connector and plug may be damaged.

When Your TV Has the S-CENTER SPEAKER IN Jack

You can output the center part of the speaker system sound from the TV by connecting the TV with the following method.

- 1** Connect the speaker system and TV with the HDMI cable (supplied) (page 17).
- 2** Connect the S-CENTER SPEAKER IN jack on the TV and the S-CENTER OUT jack on the speaker system with the TV center speaker mode cable (supplied).

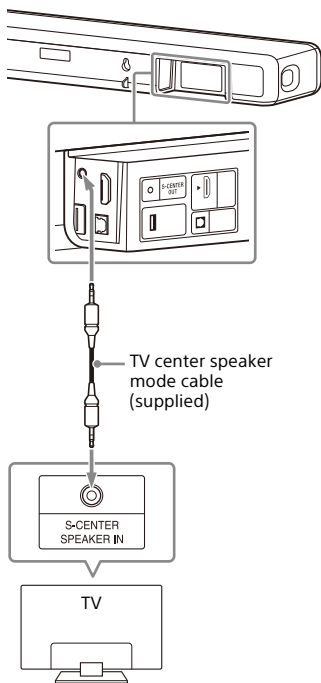

Note

Make sure that the connectors are firmly inserted.

Tip

If the length of the TV center speaker mode cable is not sufficient, use a commercially available stereo mini cable.

Connecting to the AC Outlet (mains)

- 1 Connect the AC power cord (mains lead) (supplied) to the AC inlet on the speaker system, then connect to the AC outlet (mains).

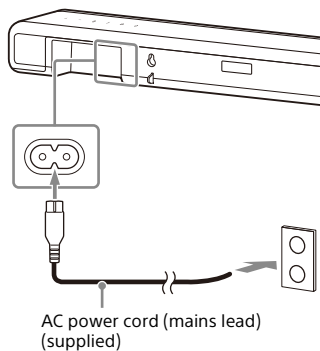

Performing Initial Settings

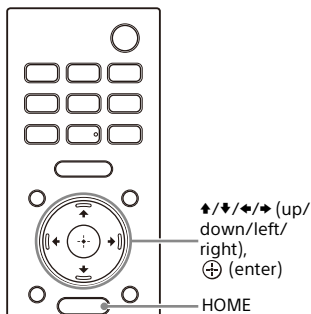

- 1 Press HOME on the remote control supplied with the speaker system to turn on the speaker system.**

Operate the remote control by pointing it toward the front of the bar speaker.

- 2 Wait until [PLEASE WAIT] in the front panel display disappears and next indication appears in the front panel display.**



- 3 Turn on the TV.**

- 4 Follow the instructions on the screen displayed on the TV to perform initial settings.**

If the initial setting screen is not displayed, use the TV remote control to switch the input on the TV to the HDMI input that is connected to the speaker system, then press HOME on the remote control of the speaker system.

Initial settings screen



- Press **▲/▼/◀/▶** (up/down/left/right) and **⊕** (enter) to select the item as instructed on the screen.
- If you use the optional subwoofer/rear speakers, connect them by following the instructions on the [Checking Wireless Speaker Connection] screen.
- Once [Setup is complete.] appears, select [Learn more].

Note

Depending on the order in which you turn on the TV and the speaker system, the speaker system may be muted and [MUTING] is displayed on the front panel display of the speaker system. If this happens, turn all devices off, then turn on the speaker system after turning on the TV.

Connecting the Optional Speaker

Connecting the Optional Speaker with the Manual Connection

The optional speaker is connected to the speaker system automatically when it is turned on. For details, refer to the operating instructions of the optional speaker.

If the optional speaker cannot be connected to the speaker system automatically, perform the manual connection by following the steps below.

- 1 Press HOME.**
The home menu appears on the TV screen.
- 2 Select  [Setup] - [Advanced Settings] on the home menu.**
- 3 Select [Speaker Settings] - [Wireless Speaker Settings] - [Start manual linking].**
The [Start manual linking] screen appears on the TV screen.
- 4 Press LINK on the optional speaker.**
The power indicator of the optional speaker that had LINK pressed flashes twice repeatedly in green.
- 5 Select [Start].**
The manual connection starts.
The connecting process appears on the TV screen.
To cancel the manual connection, select [Cancel].
- 6 When the optional speaker which you want to connect displays [Connected], select [Finish].**

7 Press (enter).

The manual connection is established and the power indicator of the optional speaker lights in green.

Notes

- If you perform [Start manual linking],  [Setup] - [Advanced Settings] - [Speaker Settings] - [Wireless Speaker Settings] - [Link mode] is set to [Manual] automatically.
- Only the speakers for which [Connected] has been displayed in step 6 connect to the speaker system. If the optional speaker is not properly connected, perform the operation again from step 1.

If Wireless Transmission Is Unstable

If you use multiple wireless systems, such as a wireless LAN, the wireless signals may become unstable. In this case, the transmission may be improved by changing the following setting.

- 1 Press HOME.**
The home menu appears on the TV screen.
- 2 Select  [Setup] - [Advanced Settings] on the home menu.**
- 3 Select [Speaker Settings] - [Wireless Speaker Settings] - [RF Channel].**
- 4 Select the setting you want.**
 - [On]: Normally select this. The speaker system automatically selects the better channel for transmission. A stronger mode for wireless interference.
 - [Off]: The speaker system selects a channel from the limited frequency band to prevent external wireless interference. If sound dropping occurs while [On]

is selected, it may be improved by selecting [Off].

Notes

- If you change the [RF Channel] setting from [Off] to [On], it may take 1 minute to reconnect.
- This setting does not appear depending on countries/regions.

Watching TV

- 1 Press HOME.**
The home menu appears on the TV screen.
- 2 Select  [Watch & Listen] - [TV] on the home menu.**
- 3 Select the program using the TV remote control.**
The selected TV program appears on the TV screen and the TV sound is output from the speaker system.
- 4 Adjust the volume (page 33).**

Note

When the bar speaker obstructs the remote control sensor of the TV and you cannot operate the TV by the TV remote control, enable the IR repeater function of the speaker system. For details, refer to Help Guide.

Tip

You can select [TV] directly by pressing TV on the remote control.

Listening to Sony TV Sound with the BLUETOOTH® Function

What You Can Do by Connecting a TV with the BLUETOOTH Function

When using Sony TV* with the BLUETOOTH function, you can listen to sound of the TV or device that is connected to the TV by connecting the speaker system and TV wirelessly.

* The TV needs to be compatible with A2DP (Advanced Audio Distribution Profile) of the BLUETOOTH profile.

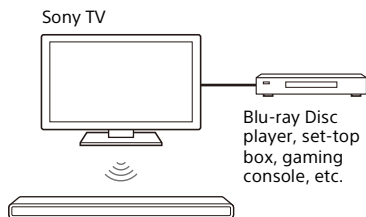

Note

If connecting the speaker system and TV by using the BLUETOOTH function, you cannot display the operation screen for the speaker system such as the home menu on the TV screen, and use functions of the speaker system other than the listening function for the sound of the TV or device that is connected to the TV.

To use all the functions of the speaker system, connect the speaker system and TV with the HDMI cable (supplied) (page 17).

Listening to TV Sound by Connecting the Speaker System and TV Wirelessly

You need to perform pairing of the speaker system and TV by using the BLUETOOTH function.

Pairing is the process required to mutually register the information on BLUETOOTH devices to be connected wirelessly in advance.

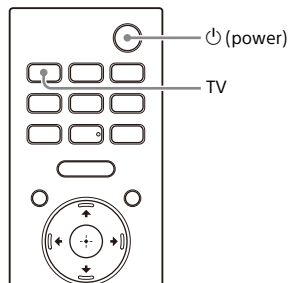

- 1 Turn on the TV.
- 2 Press **power** to turn on the speaker system.
- 3 Press and hold **BLUETOOTH** on the bar speaker and TV on the remote control simultaneously for 5 seconds.

The speaker system enters the BLUETOOTH pairing mode. [TV-BT ON] and [PAIRING] appear in order in the front panel display.

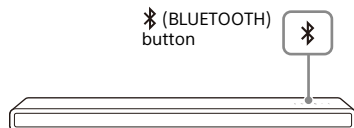

- 4** Make sure that the **BLUETOOTH indicator on the bar speaker flashes quickly in blue** and **[PAIRING]** appears in the front panel display.

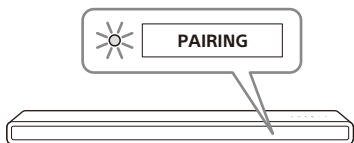

- 5** On the TV, search the speaker system by performing the pairing operation.

The list of the BLUETOOTH devices that are detected appears on the TV screen.

For the operation method to pair the BLUETOOTH device to the TV, refer to the operating instructions of the TV.

- 6** Pair the speaker system and TV by selecting "HT-A3000" from the list on the TV screen.

- 7** Make sure that the **BLUETOOTH indicator on the bar speaker lights in blue** and **[TV-BT]** appears in the front panel display.

A connection between the speaker system and TV has been established.

- 8** Select the program or input of the device by using the TV remote control.

The sound of the displayed image on the TV screen is output from the speaker system.

- 9** Adjust the volume of the speaker system by using the TV remote control.

When pressing the muting button on the TV remote control, the sound is muted temporarily.

Notes

- If the TV sound is not output from the speaker system, press TV and check the status of the front panel display and indicators on the bar speaker.
 - [TV-BT] appears in the front panel display: The speaker system and TV are connected, and TV sound is output from the speaker system.
 - The BLUETOOTH indicator flashes quickly and [PAIRING] appears in the front panel display: Perform pairing on the TV.
 - [TV] appears in the front panel display: Perform steps from the start.
- When you connect the speaker system and TV with an HDMI cable, the BLUETOOTH connection is canceled. To connect the speaker system and TV with the BLUETOOTH function again, disconnect the HDMI cable, then perform the connecting operation from the start.

Listening to Sound of the Paired TV

- 1** Turn on the TV with the TV remote control.

The speaker system is turned on by interlocking with the TV power and TV sound is output from the speaker system.

- 2** Select the program or input of the device by using the TV remote control.

The sound of the displayed image on the TV screen is output from the speaker system.

- 3** Adjust the volume of the speaker system by using the TV remote control.

When pressing the muting button on the TV remote control, the sound is muted temporarily.

Tip

When the TV is turned off, the speaker system is also turned off by interlocking with the TV power.

About operations with the remote control that is supplied with the speaker system

You can use the following buttons.

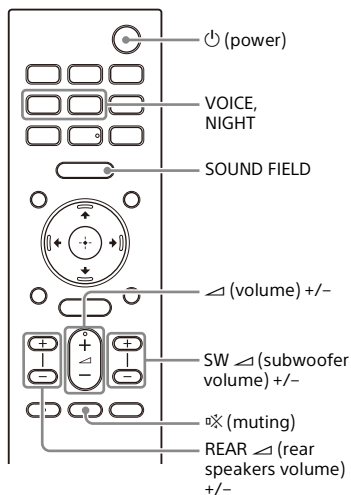

Notes

- If you select the input other than TV on the remote control supplied with the speaker system, the TV sound is not output from the speaker system. To output the TV sound, press TV on the remote control to change to the TV input.
- While the TV is connected with the BLUETOOTH function, the following remote control buttons do not work.
▲/▼/◀/▶ (up/down/left/right), ⏻ (enter), BACK, HOME, DISPLAY, OPTIONS, ▶|| (play/pause), ◀◀/▶▶ (previous/next)

Listening to Music/Sound with the BLUETOOTH Function

Listening to Music by Pairing the Mobile Device That Is Connected for the First Time

To use the BLUETOOTH function, you need to perform pairing of the speaker system and mobile device in advance.

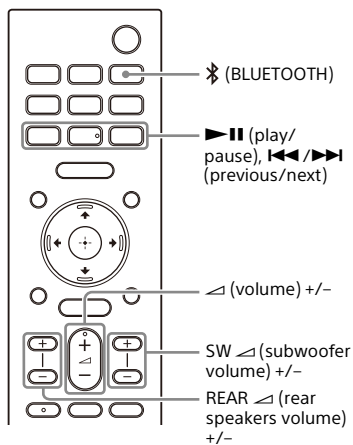

- 1 Press and hold 📶 (BLUETOOTH) for 2 seconds.

- 2** Make sure that the **BLUETOOTH** indicator on the bar speaker flashes quickly in blue and **[PAIRING]** appears in the front panel display.

The speaker system enters the pairing mode.

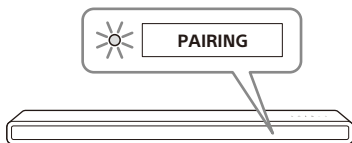

- 3** On the mobile device, search the speaker system by performing the pairing operation.

The list of the **BLUETOOTH** devices that are detected appears on the screen of the mobile device. For the operation method to pair the **BLUETOOTH** device to the mobile device, refer to the operating instructions of the mobile device.

- 4** Pair the speaker system and mobile device by selecting "**HT-A3000**" from the list on the screen of the mobile device.

If a passkey is requested, enter "0000."

- 5** Make sure that the **BLUETOOTH** indicator on the bar speaker lights in blue and **[BT]** appears in the front panel display.

A connection between the speaker system and mobile device has been established.

- 6** Start audio playback with the music app on the connected mobile device.

Sound is output from the speaker system.

- 7** Adjust the volume (page 33). You can play or pause the content by using the playback operation buttons on the remote control.

To check the connection status of the **BLUETOOTH** function

Status	BLUETOOTH indicator
In the waiting status for BLUETOOTH pairing	Flashes quickly in blue
Connection is being attempted	Flashes in blue
Connection has been established	Lights in blue

Tips

- If there is no mobile device that has been paired (ex. immediately after the purchase of the speaker system), the speaker system goes into pairing mode simply by changing the input to the **BLUETOOTH** input.
- Perform pairing for the second and subsequent mobile devices.

Listening to Music from the Paired Device

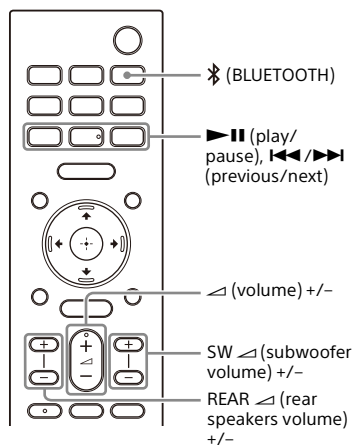

- 1** Turn the **BLUETOOTH** function of the mobile device to on.

2 Press **⌘** (BLUETOOTH).

The speaker system automatically reconnects to the mobile device it was most recently connected to.

3 Make sure that the **BLUETOOTH** indicator on the bar speaker lights in blue and **[BT]** appears in the front panel display.

A connection between the speaker system and mobile device has been established.

4 Start audio playback with the music app on the connected mobile device.

Sound is output from the speaker system.

5 Adjust the volume (page 33).

You can play or pause the content by using the playback operation buttons on the remote control.

Note

If sound delay occurs, it may be improved by setting **⌘** [Setup] - [Advanced Settings] - [Bluetooth Settings] - [Bluetooth Connection Quality] to [Priority on Stable Connection].

Tip

When the connection is not established, select "HT-A3000" on the mobile device.

To disconnect the mobile device

Perform any of the following items.

- Disable the BLUETOOTH function on the mobile device.
- Press **⌘** (BLUETOOTH) while the [Bluetooth Audio] screen appears on the TV screen.
- Set **⌘** [Setup] - [Advanced Settings] - [Bluetooth Settings] - [Bluetooth Mode] to [Transmitter] or [Off].
- Turn off the speaker system or mobile device.

Listening to Music on a USB Device

You can play music files stored on a connected USB device.

For playable types of files, see "Playable Types of Audio Files" (page 56).

1 Connect the USB device to the **⏏** (USB) port.

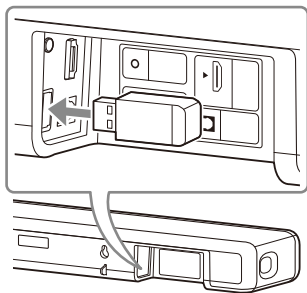

2 Press **HOME**.

The home menu appears on the TV screen.

3 Select **⏏** [Watch & Listen] - [USB (Connected)] on the home menu.

4 Select the folder on which songs are stored, then select a song.

The selected song is played and sound is output from the speaker system.

5 Adjust the volume (page 33).

Note



Do not remove the USB device during operation. To avoid data corruption or damage to the USB device, turn the speaker system off before connecting or removing the USB device.

Tip

You can select the USB input directly by pressing USB on the remote control.

Listening to Sound of the Connected TV or Device Using Headphones

Listening to Sound by Pairing with Headphones

- 1 Set the BLUETOOTH compatible headphones to pairing mode.**
Refer to the operating instructions of the headphones for the pairing method.
- 2 Press HOME.**
The home menu appears on the TV screen.
- 3 Select  [Setup] - [Advanced Settings] on the home menu.**
- 4 Select [Bluetooth Settings] - [Bluetooth Mode] - [Transmitter].**
The speaker system enters BLUETOOTH transmission mode.
- 5 Select the name of the headphones from the [Device List] in [Bluetooth Settings].**
When the BLUETOOTH connection is established, [Connected] appears. If you cannot find the name of your headphones in [Device List], select [Scan].
- 6 Return to the home menu, select  [Watch & Listen], and select the input.**
The image of the selected input appears on the TV screen, [BT TX] appears in the front panel display, then the sound is output from the headphones.
Sound from the speaker system is muted at the same time.

- 7 Adjust the volume.**
Adjust the volume level of the headphones first. Then, adjust the volume level of the headphones with +/- on the bar speaker or  (volume) +/- on the remote control.

To remove the paired headphones from the device list

- 1 Press HOME.**
The home menu appears on the TV screen.
- 2 Select  [Setup] - [Advanced Settings] on the home menu.**
- 3 Select [Bluetooth Settings] - [Device List].**
- 4 Move the cursor to the name of the headphones that you want to remove, and then press DISPLAY.**
To remove all the paired headphones from the device list, press AUDIO.
- 5 Follow the on-screen instructions to remove the desired headphones from the device list.**

Note

To display the paired headphones on the device list, Set  [Setup] - [Advanced Settings] - [Bluetooth Settings] - [Bluetooth Mode] to [Transmitter].

Listening to Sound with Paired Headphones

1 Set the BLUETOOTH function of the headphones to on.

2 Press HOME.

The home menu appears on the TV screen.

3 Select  [Setup] - [Advanced Settings] on the home menu.

4 Select [Bluetooth Settings] - [Bluetooth Mode] - [Transmitter].

The speaker system enters BLUETOOTH transmission mode and the speaker system automatically reconnects to the headphones that was most recently connected to.

5 Return to the home menu, select  [Watch & Listen], and select the input.

The image of the selected input appears on the TV screen, [BT TX] appears in the front panel display, then the sound is output from the headphones.



Sound from the speaker system is muted at the same time.

6 Adjust the volume.

Adjust the volume level of the headphones first. Then, adjust the volume level of the headphones with +/- on the bar speaker or  (volume) +/- on the remote control.

To disconnect the paired headphones

Perform any of the following items.

- Disable the BLUETOOTH function on the headphones.
- Set  [Setup] - [Advanced Settings] - [Bluetooth Settings] - [Bluetooth Mode] to [Receiver] or [Off].
- Turn off the speaker system or headphones.
- Select the device name of the connected headphones from  [Setup] - [Advanced Settings] - [Bluetooth Settings] - [Device List]. [Connected] of the device name disappears.

About the Connection of the Headphones

- You may not be able to adjust the volume level depending on the BLUETOOTH compatible headphones.
- Input of BLUETOOTH is disabled when  [Setup] - [Advanced Settings] - [Bluetooth Settings] - [Bluetooth Mode] is set to [Off] or [Transmitter].
- You can register up to 9 BLUETOOTH devices. If a 10th BLUETOOTH device is registered, the oldest connected BLUETOOTH device will be overwritten by the new one.
- The speaker system can display up to 15 detected BLUETOOTH devices in the [Device List] (page 29).
- You cannot change the sound effect or settings while transmitting sound to the BLUETOOTH compatible headphones.
- Playback of audio/music on the BLUETOOTH device is delayed compared to that on the speaker system due to the characteristics of BLUETOOTH wireless technology.
- You can enable or disable the reception of LDAC audio from the BLUETOOTH device in [Bluetooth Settings].

What You Can Do by Connecting the Speaker System to a Network

You can perform streaming playback of music content via the speaker system by operating a smartphone, tablet, or iOS device, or play music stored on a computer via the speaker system by connecting to the network.

For details of functions and operations, refer to Help Guide.



Speaker system

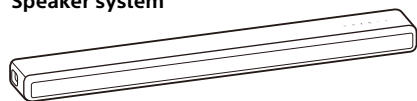

iOS device/smartphone/ tablet

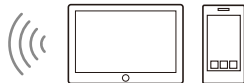

- 360 Reality Audio
- Spotify
- Chromecast built-in
- AirPlay
- Sony | Music Center

Computer



- AirPlay
- Home Network

360 Reality Audio

You can play 360 Reality Audio contents on the speaker system by selecting it on the streaming service app compatible with 360 Reality Audio.

Spotify

You can select music on the Spotify app and play it on the speaker system. Use your phone, tablet or computer as a remote control for Spotify. Go to spotify.com/connect to learn how.

Chromecast built-in™

You can select music on the Chromecast-enabled app and play it on the speaker system.

AirPlay

The speaker system supports AirPlay. You can play music on the speaker system by operating an iOS device or a computer.

Sony | Music Center

You can control the speaker system wirelessly by installing the “Sony | Music Center” app on your smartphone or tablet device.

Home Network

You can play music files stored on your computer on a network location via your home network.

Adjusting the Volume and Sound Quality

Adjusting the Volume

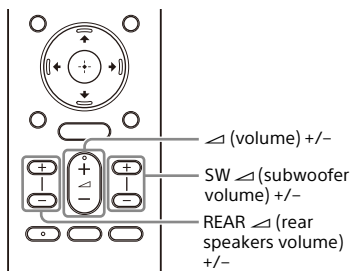

To adjust the speaker system volume

Press \triangleleft (volume) +/-.

The volume level appears in the front panel display.

To adjust the subwoofer volume

Press SW \triangleleft (subwoofer volume) +/-.

The volume level appears in the front panel display.

Note

The subwoofer is designed for playback of bass or low frequency sound. When the input source, such as in TV programs, does not contain much bass sound, the bass sound from the subwoofer may be difficult to hear.

Tip

When connecting the optional subwoofer, the optional subwoofer level is adjusted instead of the built-in subwoofer level.

To adjust the optional rear speaker volume

Press REAR \triangleleft (rear speakers volume) +/-.

The volume level appears in the front panel display.

Notes

- The optional rear speakers are designed for playback of the surround part of the multi-channel sound and surround sound that is created from the 2-channel sound using virtual processing. When the input source does not contain much surround sound, the surround sound from the optional rear speakers may be difficult to hear.
- REAR \triangleleft (rear speakers volume) +/- does not work when the optional rear speakers are not connected.

Enjoying Surround Effect (SOUND FIELD)

You can turn the surround effect on or off to suit sound sources.

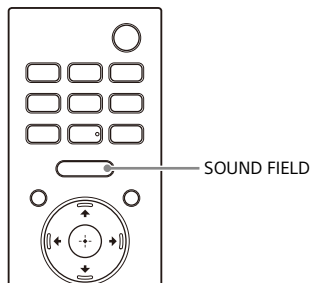

1 Press SOUND FIELD to select the setting.

The setting appears in the front panel display.

Setting	Explanation
[SF.ON]	The sound is output with the surround effect. This setting is suitable for experiencing the surround sound with presence regardless of the genre.
[SF.OFF]	The sound is output without the surround effect.

Notes

- You cannot change the setting in the following conditions even if you press SOUND FIELD.
 - The BLUETOOTH device is connected in BLUETOOTH transmission mode (page 29).
 - A test tone is emitted.
- This setting may be fixed depending on the sound source.
- You cannot change the setting of [Sound Field Setting] in [Setup] - [Advanced Settings] - [Audio Settings] when

[Setup] - [Advanced Settings] - [Audio Settings] - [360 Spatial Sound Mapping] is set to [On].

Tip

You can select the type of the surround effect in [Setup] - [Advanced Settings] - [Audio Settings] - [Sound Field Setting].

Making Dialogs Clearer (VOICE)

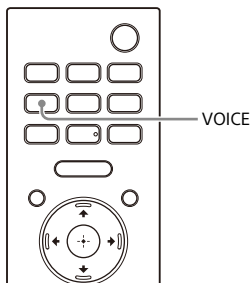

1 Press VOICE to select the setting.

The setting appears in the front panel display.

Setting	Explanation
[Vo.ON]	Dialog is easily heard by enhancing dialog range.
[Vo.OFF]	Deactivates the voice mode function.

Note

When the BLUETOOTH device is connected in BLUETOOTH transmission mode (page 29), the voice mode is disabled.

Enjoying Clear Sound with Low Volume at Midnight (NIGHT)

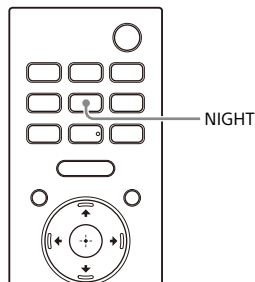

1 Press NIGHT to select the setting.

The setting appears in the front panel display.

Setting	Explanation
[N.ON]	Sound is output at low volume with minimum loss of fidelity and clarity of dialog.
[N.OFF]	Deactivates the night mode function.

Notes

- When you turn the speaker system off, this setting is set to [N.OFF] automatically.
- When the BLUETOOTH device is connected in BLUETOOTH transmission mode (page 29), the night mode is disabled.

Adjusting the Delay Between the Picture and Sound

When the sound does not match the pictures on the TV screen, you can adjust the delay between the picture and sound.

The setting method differs depending on the input.

For details, refer to Help Guide.

Enjoying Multiplex Broadcast Sound (AUDIO)

You can enjoy multiplex broadcast sound when the speaker system receives a Dolby Digital multiplex broadcast signal.

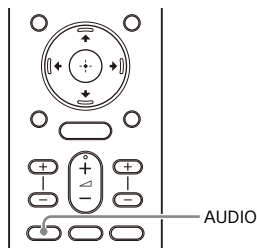

1 Press **AUDIO** to select the setting.

The setting appears in the front panel display.

Setting	Explanation
[MAIN]	Sound of the main language is output.
[SUB]	Sound of the sub language is output.
[MN/SB]	Main sound is output from the left speaker and sub sound is output from the right speaker.

Notes

- To output Dolby Digital sound, you need to connect a TV that is compatible with eARC or ARC (page 17) to the HDMI OUT (TV eARC/ARC) jack with the HDMI cable (supplied).
- If your TV's HDMI IN jack is not compatible with eARC or ARC (page 17), connect the TV to the TV IN (OPT) jack with an optical digital cable (not supplied) to output Dolby Digital sound.

Adjusting the Dialog Volume While the DTS:X Content is Played Back

By adjusting the dialog volume, you can easily listen to dialog since it stands out from the ambient noise. This function works while playing content that is compatible with the DTS:X dialog control function.

The setting method differs depending on the input.

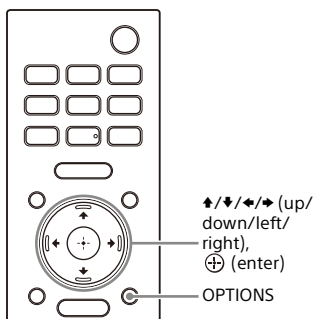

1 Press **OPTIONS**, display **[DIALOG]** in the front panel display using **⬆️/⬇️** (up/down), then press **⊕** (enter).

2 Adjust the dialog volume using **⬆️/⬇️** (up/down), then press **⊕** (enter).

You can adjust from 0.0 dB to 6.0 dB in 1.0 dB increments.

3 Press **OPTIONS**.

The options menu in the front panel display turns off.

Using the Speaker System by Interlocking with a TV

Operating the Speaker System by Interlocking with a TV (Control for HDMI Function)

Connecting a TV compatible with the Control for HDMI function using an HDMI cable enables you to interlock the speaker system operation such as power on/off or volume adjustment with a TV.

About the Control for HDMI function

The Control for HDMI function is a function that enables operation of devices connected with an HDMI (High-Definition Multimedia Interface) cable by interlocking them.

Although this function works for devices compatible with the Control for HDMI function, it may not work if connecting devices other than those manufactured by Sony.

Preparing to Operate by Interlocking with a TV

Enable the Control for HDMI function settings of the TV connected to the speaker system with an HDMI cable. The default setting of the Control for HDMI function of the speaker system is [On].

Tips

- When connecting a device such as a Blu-ray Disc player to a TV with an HDMI cable, enable its Control for HDMI function.
- To enable the Control for HDMI function of a TV or Blu-ray Disc player, refer to their operating instructions.

- If you enable the Control for HDMI ("BRAVIA" sync) function when using a TV manufactured by Sony, the Control for HDMI function of the speaker system is also enabled automatically. When the setting is complete, [DONE] appears in the front panel display.

Performing Power Operation or Volume Adjustment by a TV Remote Control

When turning the TV on/off or adjusting the volume using the TV remote control, the speaker system power operation or volume adjustment is interlocked.

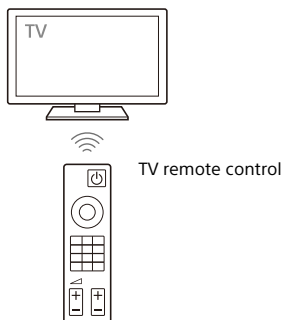

Power interlocking

When you turn on or off the TV, the speaker system will turn on or off automatically.

Note

If you turn off the speaker system before turning off the TV, the speaker system may not turn on automatically even though you turn on the TV next time. In this case, perform the following operation.

- Select the speaker system for the sound output device in the TV menu.
- When using Sony TV, turn on the speaker system while the TV is turned on.

Volume adjustment

The sound of the TV you are watching is output from the speaker system automatically. You can adjust the speaker system volume by the TV remote control.

Other Interlocking Functions

Menu Operation by TV Remote Control

You can operate the menu of the speaker system by selecting the name of the speaker system when changing input or operating the Sync Menu on the TV.

Note

Some Sony TVs support the Sync Menu. Refer to the operating instructions of your TV to see if your TV supports the Sync Menu.

Language Follow

When you change the language for the on-screen display of the TV, the speaker system's on-screen display language is also changed.

Tip

You can change the Control for HDMI settings by selecting  [Setup] - [Advanced Settings] - [HDMI Settings] on the home menu.

Operating the Speaker System by Interlocking with a TV Compatible with the "BRAVIA" Sync Function

"BRAVIA" Sync is an extended function developed by Sony based on the Control for HDMI function. By connecting "BRAVIA" Sync-compatible devices such as a TV or a Blu-ray Disc player using an HDMI cable, you can control the devices by interlocking them with each other.

To use "BRAVIA" Sync

"BRAVIA" Sync is enabled by enabling the Control for HDMI function of the Sony device. For the operation to enable the Control for HDMI function, see "Preparing to Operate by Interlocking with a TV" (page 38).

What You Can Do with "BRAVIA" Sync

Control for HDMI function

- Power interlocking (page 38)
- Volume adjustment (page 39)
- Menu Operation by TV Remote Control (page 39)
- Language Follow (page 39)

Home Theatre Control Function

Setting the speaker system, input switching, etc. can be done without switching the TV input.

Changing the Settings

Changing the Brightness of the Front Panel Display and Indicators (DIMMER)

You can change the brightness of the front panel display and BLUETOOTH indicator. The brightness of the indicators for the optional subwoofer and rear speakers also changes.

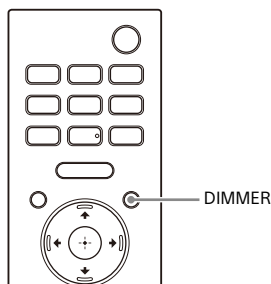

- 1 Press **DIMMER** to select the setting.

The setting appears in the front panel display.

Setting	Explanation
[BRIGHT]	The front panel display and indicators light brightly.
[DARK]	The front panel display and indicators light darkly.
[OFF]	The front panel display and indicators are turned off.

Note

The front panel display and indicators are turned off when [OFF] is selected. They turn on automatically when you press any button, then turn off again if you do not operate the speaker system for about 10

seconds. However, in some cases, the front panel display and indicators may not turn off. In this case, the brightness of the front panel display and indicators are the same as [DARK].

Saving Power in Standby Mode

Check that  [Setup] - [Advanced Settings] - [System Settings] - [Network/Bluetooth Standby] is set to [Off].

Entering the Network Standby Mode or Standby Mode Automatically

- 1 Press HOME.**
The home menu appears on the TV screen.
- 2 Select  [Setup] - [Advanced Settings] on the home menu.**
- 3 Select [System Settings] - [Auto Standby] - [On].**
When you do not operate the speaker system while no signal is input for about 20 minutes, the speaker system enters the network standby mode or standby mode automatically.

Note

Disabling the [Auto Standby] function will increase the power consumption of this speaker system because the speaker system will not turn off automatically when not being used.

Performing Easy Setup

You can make basic initial settings, speaker settings, and network settings for the speaker system easily by performing Easy Setup.

- 1 Press HOME.**
The home menu appears on the TV screen.
- 2 Select  [Setup] - [Easy Setup] on the home menu.**
The [Easy Setup] screen appears on the TV screen.
- 3 Select the desired setting.**
 - [Easy Initial Setup]: Performs the basic initial settings including the speaker settings and network settings.
 - [Easy Sound Setup]: Performs the basic speaker settings for optimizing the surround sound for your environment.
 - [Easy Network Setup]: Performs the basic network settings.
- 4 Perform settings by following the on-screen instructions.**

Performing Advanced Settings

Using the [Advanced Settings] Menu

You can make various adjustments to items such as picture and sound on the [Advanced Settings] menu.

1 Press HOME.









The home menu appears on the TV screen.

2 Select [Setup] - [Advanced Settings] on the home menu.

The [Advanced Settings] screen appears on the TV screen.

3 Select the setting item.

For details about the setting items, refer to Help Guide.

Setting item	Explanation
 [Speaker Settings]	Makes the speakers settings for installing and connections.
 [Audio Settings]	Makes the audio output settings.
 [HDMI Settings]	Makes the HDMI settings.
 [Bluetooth Settings]	Makes detailed settings for the BLUETOOTH function.
 [System Settings]	Makes the speaker system-related settings.
 [Network Settings]	Makes detailed settings for the Internet.
 [Resetting]	Resets the speaker system to the factory default settings.
 [Software Update]	Updates the software of the speaker system or optional subwoofer/rear speakers.

Updating the Software

By updating your software to the latest version, you can take advantage of the newest functions.

For information about update functions, visit the following website:

- For customers in Americas
<https://www.sony.com/am/support>
- For customers in Europe
<https://www.sony.eu/support>
- For customers in Asia-Pacific, Oceania, Middle East, and Africa
<https://www.sony-asia.com/support>

Notes

- It may take up to 20 minutes for the update to be completed.
- An Internet environment is necessary to perform updates via the Internet.
- While the updating operation is in progress, do not turn on or off the speaker system, disconnect the AC power cord (mains lead), disconnect/connect an HDMI cable, or operate the speaker system or TV. Wait for the software update to complete.
- Set  [Setup] - [Advanced Settings] - [Network Settings] - [Auto Update Settings] - [Auto Update] to [On] when you want to perform software updates automatically. Software update may be performed even if you select [Off] in [Auto Update] depending on the details of the updates. For details, refer to Help Guide.

- 1 When using the optional subwoofer, make sure that it is turned on and connected to the speaker system. When using the rear speakers, make sure that they are connected to the wall outlet (mains), turned on, and connected to the speaker system.**

The power indicator(s) of the optional subwoofer and/or rear speaker light(s) in green.

- 2 Press HOME.**

The home menu appears on the TV screen.



- 3 Select  [Setup] - [Advanced Settings] on the home menu.**

If the speaker system detects update information for the speaker system on the network, the update notification and [Software Update] appear on the home menu. In this case, select [Software Update] and follow the on-screen instructions.

- 4 Select [Software Update].**

The [Software Update] screen appears on the TV screen.

- 5 Select the item for updating.**

Select the updating item from the following items by pressing / (up/down) and  (enter), then update the software by following the on-screen instructions.

When a software update starts, the speaker system automatically reboots.

During a software update, [UPDATE] appears in the front panel display. After the update is complete, the speaker system automatically reboots.

[Network Update]

Updates the software using the available network. Make sure that the network is connected to the Internet.



[USB Update]

Updates the software using a USB memory. For details on updating, refer to the instructions that are displayed when downloading the update file.

[Wireless Speakers Update]

Updates the software of the optional subwoofer and rear speakers when the software of the speaker system is the latest version.

Notes

- You can perform [USB Update] by pressing and holding  (BLUETOOTH) and  (power) on the bar speaker for 7 seconds.
- If updating of the optional subwoofer or rear speakers does not work, move them to a location near the bar speaker and update.

Troubleshooting

If the speaker system does not work properly, handle it in the following order.

1 Search for the cause and solution of the issue by referring to these Operating Instructions or Help Guide.

The troubleshooting method is listed in "Troubleshooting."
For the functions that are not mentioned in Operating Instructions, refer to Help Guide.

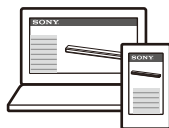

- For customers in Americas

https://rd1.sony.net/help/ht/a3000/h_uc/



- For customers in other countries/regions

https://rd1.sony.net/help/ht/a3000/h_zz/



2 Search for the cause and solution of the issue on the Sony support site.

Sony support site provides latest support information and Frequently Asked Questions.

- For customers in Americas
<https://www.sony.com/am/support>
- For customers in Europe
<https://www.sony.eu/support>
- For customers in Asia-Pacific, Oceania, Middle East, and Africa
<https://www.sony-asia.com/support>



3 Reset the speaker system.

All the settings of the speaker system return to their initial status (page 52).



4 Should any problems persist, consult your nearest Sony dealer.



Power

The speaker system does not power up.

- Check that the AC power cord (mains lead) is connected securely.
- Disconnect the AC power cord (mains lead) from the wall outlet (mains), and then reconnect after several minutes.

The speaker system does not turn on even when the TV is turned on.

- Set  [Setup] - [Advanced Settings] - [HDMI Settings] - [Control for HDMI] to [On]. The TV must support the Control for HDMI function (page 38). For details, refer to the operating instructions of your TV.
- Check the speaker settings of the TV. The speaker system power syncs with the speaker settings of the TV. For details, refer to the operating instructions of your TV.
- Depending on the TV, if the sound was output from the speakers of the TV the previous time, the speaker system may not turn on by interlocking with the TV power even when the TV is turned on.

The speaker system turns off when the TV is turned off.

- Check the setting of  [Setup] - [Advanced Settings] - [HDMI Settings] - [Standby Linked to TV]. When [Standby Linked to TV] is set to [On] or [Auto], the speaker system turns off automatically when you turn off the TV.

The speaker system does not turn off even when the TV is turned off.

- Check the setting of  [Setup] - [Advanced Settings] - [HDMI Settings] - [Standby Linked to TV]. To turn the speaker system off automatically, regardless of the input when you turn off the TV, set [Standby Linked to TV] to [On]. The TV must support the Control for HDMI function (page 38).

For details, refer to the operating instructions of your TV.

The speaker system cannot be turned off.

- The speaker system may be in demo mode. To cancel demo mode, reset the speaker system. Press and hold  (power) and - (volume) on the bar speaker for more than 5 seconds (page 52).

Picture

There is no picture or the picture is not output correctly.

- Select the appropriate input (page 23).
- When there is no picture while the TV input is selected, select the TV channel that you want using the TV remote control.
- Disconnect an HDMI cable, then connect it again. Make sure that the cable is firmly inserted.

The picture on the TV screen is distorted.

- Interference of the wireless function between the TV/other wireless devices and the speaker system may have occurred. Install the speaker system far away from the TV/other wireless devices.
- There is an interference of the frequency band between the wireless LAN and the wireless connection of the optional speakers. Switch the band of the wireless LAN connection of the TV or device that is playing an image to 2.4 GHz.



Sound

The speaker system cannot connect to a TV with the BLUETOOTH function.

- When you connect the speaker system and TV with an HDMI cable,

the BLUETOOTH connection is canceled.

No TV sound is output from the speaker system.

- Check the type and connection of an HDMI cable, TV center speaker mode cable, or optical digital cable that is connected to the speaker system and the TV (page 17).
- Disconnect the cables that are connected to the TV and the speaker system, then connect them firmly again. Disconnect the AC power cords (mains leads) of the TV and the speaker system from the AC outlets (mains), then connect them again.
- When the speaker system and TV are connected with an HDMI cable, check the following.
 - The HDMI jack of the connected TV is labeled with "eARC" or "ARC."
 - The Control for HDMI function of the TV is set to on.
 - The eARC or ARC function of the TV is enabled.
 - The number of connected devices that can be controlled by the Control for HDMI function has not exceeded the limit.
 - On the speaker system,  [Setup] - [Advanced Settings] - [HDMI Settings] - [Control for HDMI] is set to [On] and  [Setup] - [Advanced Settings] - [HDMI Settings] - [TV Audio Input Mode] is set to [Auto].
- If your TV is not compatible with eARC, set  [Setup] - [Advanced Settings] - [HDMI Settings] - [eARC] to [Off].
- If your TV is not compatible with eARC or ARC, connect an optical digital cable (page 17). If the TV is not compatible with eARC or ARC, TV sound will not be output from the speaker system even if the speaker system is connected to the TV's HDMI IN jack.
- Switch the input of the speaker system to the TV input.

- Increase the volume on the speaker system or cancel muting.
- Depending on the order in which you turn on the TV and the speaker system, the speaker system may be muted and [MUTING] is displayed on the front panel display of the speaker system. If this happens, turn on the TV first, then the speaker system.
- Press TV/AUDIO SYSTEM on the remote control to switch the output for the connected TV sound or set the speakers setting of your TV to Audio System. Refer to the operating instructions of your TV regarding how to set the TV.

The sound is output from both the speaker system and TV.



- Mute the sound of the speaker system or TV.
- When you connect the speaker system and TV with the TV center speaker mode cable and set  [Setup] - [Advanced Settings] - [Speaker Settings] - [TV Center Speaker Settings] - [TV Center Speaker Mode] to [On], the center part of the speaker system sound is output from the TV. For detail, refer to Help Guide.

The TV sound from this speaker system lags behind the image.

- Set the adjustment value of the delay between the picture and sound to 0 msec if it is set to the range between 25 msec and 300 msec. For details, refer to Help Guide.
- A time gap between the sound and picture may occur depending on the sound source. If your TV has a function that delays the image, use it for adjustment. For details, refer to the operating instructions of your TV.

No sound or only a very low-level sound of the device connected to the speaker system is heard.

- Press  (volume) + on the remote control and check the volume level (page 12).

- Press  (muting) or  (volume) + on the remote control to cancel the muting function (page 12).
- Make sure the input source is selected correctly. You should try other input sources by pressing the input select button on the remote control (TV/USB/BLUETOOTH).
- Make sure that the connectors are firmly inserted.

The surround effect cannot be obtained.

- Depending on the combination of the setting of SOUND FIELD (page 34) and input signal, surround sound processing may not work effectively. The surround effect may be subtle, depending on the program or disc.

Sound is not output from some speakers.

- Depending on the combination of the setting of SOUND FIELD (page 34) and sound source, some speakers may not output sound.

Sound Field Optimization

Sound Field Optimization failed.

- When using the optional rear speakers, install them upright so that the labels on the bottom of the speakers are directed downwards.
- Perform Sound Field Optimization again in a situation where the surrounding is quiet.
- If the distance between the bar speaker and optional rear speakers/ subwoofer is too close or far away from each other, Sound Field Optimization cannot be performed properly. Adjust the distance between speakers and perform Sound Field Optimization again.
- If there is any obstacle between speakers or the microphone for measurement of the speaker is blocked by an obstacle, Sound Field Optimization cannot be performed

properly. Remove it if there is any obstacle between speakers or in front of speakers.

USB Device Connection

The USB device is not recognized.

- Try the following:
 - ① Turn the speaker system off.
 - ② Remove and reconnect the USB device.
 - ③ Turn the speaker system on.
- Make sure that the USB device is securely connected to the  (USB) port (page 28).
- Check to see if the USB device is damaged.
- Make sure that the USB device is turned on.
- If the USB device is connected via a USB hub or cable, disconnect it and connect the USB device directly to the speaker system.
- When connecting a WALKMAN® or smartphone, its internal storage or external storage (such as a memory card) may not be recognized.

Mobile Device Connection

Pairing cannot be achieved.

- Bring this speaker system and the BLUETOOTH device closer together.
- Make sure this speaker system is not receiving interference from a wireless LAN device, other 2.4 GHz wireless devices, or a microwave oven. If a device that generates electromagnetic radiation is nearby, move the device away from this speaker system.

BLUETOOTH connection cannot be completed.

- Make sure that the BLUETOOTH indicator of the bar speaker is lit (page 27).

- Make sure the BLUETOOTH device to be connected with is turned on and the BLUETOOTH function is enabled.
- Bring this speaker system and the BLUETOOTH device closer together.
- Pair this speaker system and the BLUETOOTH device again. You may need to cancel the pairing with this speaker system using your BLUETOOTH device first.
- Pairing information may be deleted. Perform the pairing operation again (page 26).

Sound of the connected BLUETOOTH mobile device is not output from the speaker system.

- Make sure that the BLUETOOTH indicator of the bar speaker is lit (page 27).
- Bring this speaker system and the BLUETOOTH device closer together.
- If a device that generates electromagnetic radiation, such as a wireless LAN device, other BLUETOOTH devices, or a microwave oven is nearby, move the device away from this speaker system.
- Remove any obstacle between this speaker system and the BLUETOOTH device or move this speaker system away from the obstacle.
- Reposition the connected BLUETOOTH device.
- Switch the wireless LAN frequency of any nearby wireless LAN router or PC to the 5 GHz range.
- Increase the volume on the connected BLUETOOTH device.

Headphones Connection with the BLUETOOTH Function

Pairing cannot be achieved.

- Bring this speaker system and the BLUETOOTH headphones closer together.

- Make sure this speaker system is not receiving interference from a wireless LAN device, other 2.4 GHz wireless devices, or a microwave oven. If a device that generates electromagnetic radiation is nearby, move the device away from this speaker system.

BLUETOOTH connection cannot be completed.

- Make sure that the BLUETOOTH indicator of the bar speaker is lit (page 27).
- Make sure the BLUETOOTH headphones to be connected with is turned on and the BLUETOOTH function is enabled.
- Bring this speaker system and the BLUETOOTH headphones closer together.
- Pair this speaker system and the BLUETOOTH headphones again. You may need to cancel the pairing for the BLUETOOTH headphones with this speaker system first. See "To remove the paired headphones from the device list" (page 29).
- Pairing information may be deleted. Perform the pairing operation again (page 29).

No sound is output from the connected BLUETOOTH headphones.

- Make sure that the BLUETOOTH indicator of the bar speaker is lit (page 27).
- Bring this speaker system and the BLUETOOTH headphones closer together.
- If a device that generates electromagnetic radiation, such as a wireless LAN device, other BLUETOOTH devices, or a microwave oven is nearby, move the device away from this speaker system.
- Remove any obstacle between this speaker system and the BLUETOOTH

- headphones, or move this speaker system away from the obstacle.
- Reposition the connected BLUETOOTH headphones.
- Switch the wireless LAN frequency of any nearby wireless LAN router or PC to the 5 GHz range.
- Increase the volume on the connected BLUETOOTH headphones.
- Set  [Setup] - [Advanced Settings] - [Bluetooth Settings] - [Wireless Playback Quality] to [LDAC Stable Connection (Auto)] or [SBC Stable Connection (Auto)].
- Some content may not be output due to content protection.

Remote Control

The remote control of this speaker system does not function.



- Point the remote control at the remote control sensor on the bar speaker (page 10).
- Remove any obstacles in the path between the remote control and the speaker system.
- Replace both batteries in the remote control with new ones if they are weak.
- Make sure you are pressing the correct button on the remote control.



TV remote control does not work.

- This problem might be solved by enabling the IR repeater function. For details, refer to Help Guide.



Optional Speakers

No sound or only a very low-level sound is heard from the optional speaker.

- Press SW  (subwoofer volume) + on the remote control to increase the subwoofer volume, or press REAR  (rear speakers volume) + to increase the rear speaker volume (page 33).

- Check the wireless connection status in  [Setup] - [Advanced Settings] - [Speaker Settings] - [Wireless Speaker Settings] - [Check wireless connection].
- Set the night mode to off (page 35).
- If you change the  [Setup] - [Advanced Settings] - [Speaker Settings] - [Wireless Speaker Settings] - [RF Channel] setting from [Off] to [On], it may take 1 minute for the sound to be output (page 21).
- Refer to the operating instructions of the optional rear speakers/subwoofer.

Sound skips or has noise.

- If there is a device nearby that generates electromagnetic waves, such as a wireless LAN or a microwave oven in use, set the optional speaker and the speaker system apart from it.
- If there is an obstacle between the optional speaker and the speaker system, move or remove it.
- Set the optional speaker and the speaker system in a position as close as possible.
- Change the  [Setup] - [Advanced Settings] - [Speaker Settings] - [Wireless Speaker Settings] - [RF Channel] setting to [Off], and then change to [On] again.
- Switch the network connection of the TV or Blu-ray Disc player from wireless to wired.
- Set  [Setup] - [Advanced Settings] - [Speaker Settings] - [Wireless Speaker Settings] - [Wireless Playback Quality] to [Connection].

Others

The Control for HDMI function does not work properly.

- Check the connection with the speaker system (page 17).
- Enable the Control for HDMI function on the TV. For details, refer to the operating instructions of your TV.

- Wait a while, and then try again. If you unplug the speaker system, it will take a while before operations can be made. Wait for 15 seconds or longer, and then try again.
- Make sure the TV connected to the speaker system support the Control for HDMI function.
- The type and number of devices that can be controlled by the Control for HDMI function are restricted by the HDMI CEC standard as follows:
 - Recording devices (Blu-ray Disc recorder, DVD recorder, etc.): up to 3 devices
 - Playback devices (Blu-ray Disc player, DVD player, etc.): up to 3 devices (this speaker system uses one of them)
 - Tuner-related devices: up to 4 devices
 - Audio system (receiver/ headphones): up to 1 device (used by this speaker system)

[PRTCT] flashes in the front panel display for 5 seconds and the speaker system is turned off.

- Disconnect the AC power cord (mains lead) and make sure nothing is obstructing the ventilation holes of the speaker system.

[PRTCT], [PUSH], speaker name ([SUB], [RL], or [RR]), and [POWER] flash alternately in the front panel display.

- Press  (power) on the corresponding speaker ([SUB]: optional subwoofer, [RL]: optional left rear speaker, [RR]: optional right rear speaker) to turn each off. For the optional rear speaker, disconnect the AC power cord (mains lead), then restart the speaker system. For the optional subwoofer, disconnect the AC power cord (mains lead) and make sure nothing is obstructing the ventilation holes of the optional subwoofer, then restart the speaker system. If they are

reconnected properly, the display in the front panel display returns to the normal display.

[HIGH], [TEMP], and [ERROR] appear alternately for 2 seconds each in the front panel display, [STANDBY] appears in the front panel display, then the speaker system is turned off.

- High-temperature is detected in the speaker system. Press  (power) to restart the speaker system.

[BT TX] appears in the front panel display.

- Set  [Setup] - [Advanced Settings] - [Bluetooth Settings] - [Bluetooth Mode] to [Receiver]. [BT TX] appears in the front panel display if [Bluetooth Mode] is set to [Transmitter].

Sensors of the TV do not work properly.

- The bar speaker may block some sensors (such as the brightness sensor), the remote control receiver of your TV or the emitter for 3D glasses (infrared transmission) of a 3D TV that supports the infrared 3D glass system, or wireless communication. Move the bar speaker away from the TV within a range that allow those parts to operate properly. For the locations of the sensors and remote control receiver, refer to the operating instructions of the TV.

Wireless functions (wireless LAN, the BLUETOOTH function, or optional subwoofer/rear speakers) are unstable.

- Do not place metal objects other than a TV around the speaker system.

Music that you are not familiar with suddenly plays.

- The pre-installed sample music may have been played. Press  (input select) on the bar speaker to stop playback.

The speaker system cannot be turned off or [Advanced Settings] cannot be used. When pressing  (power), [.DEMO] appears in the front panel display and the speaker system cannot be turned off.

→ The speaker system may be in demo mode. To cancel demo mode, reset the speaker system (page 52). Press and hold  (power) and – (volume) on the bar speaker for more than 5 seconds.

The speaker system restarts.

→ When connecting to a TV with a resolution that is different from that of the speaker system, the speaker system may restart to reset the picture output setting.

Resetting the Speaker System

If the speaker system still does not operate properly, reset the speaker system as follows.

- 1 Press HOME.**
The home menu appears on the TV screen.
- 2 Select  [Setup] - [Advanced Settings] on the home menu.**
- 3 Select [Resetting].**
- 4 Select the menu item you want to reset.**
- 5 Select [Start].**

To cancel resetting

Select [Cancel] in step 5.

If You Cannot Perform Resetting Using the Home Menu

- 1 Press and hold  (power) and – (volume) on the bar speaker for more than 5 seconds.**

The settings return to their initial status.

Note

By resetting, the link with the optional subwoofer and rear speakers may be lost. In this case, reconnect them by referring to their operating instructions.

Additional Information

Specifications

Sound Bar (HT-A3000)

Amplifier section

POWER OUTPUT (rated)

Front L + Front R: 33 W + 33 W (at 6 ohms, 1 kHz 1 %THD)

POWER OUTPUT (reference)

Front L/Front R speaker blocks: 50 W (per channel at 6 ohms, 1 kHz)

Center speaker block: 50 W (at 6 ohms, 1 kHz)

Subwoofer blocks: 50 W (per channel at 6 ohms, 100 Hz)

Inputs

TV IN (OPT)

Outputs

HDMI OUT (TV eARC/ARC)

S-CENTER OUT

HDMI Section

Connector

Type A (19pin)

USB section

⚡ (USB) port: 1 A

Type A (For connecting USB memory)

Wireless LAN section

Communication system

IEEE 802.11 a/b/g/n/ac

Frequency band

2.4 GHz, 5 GHz

BLUETOOTH section

Communication system

BLUETOOTH Specification version 5.0

Output

BLUETOOTH Specification Power Class 1

Maximum communication range

Line of sight approx. 30 m¹⁾

Maximum number of devices to be registered

9 devices

Frequency band

2.4 GHz band (2.4000 GHz - 2.4835 GHz)

Modulation method

FHSS (Freq Hopping Spread Spectrum)

Compatible BLUETOOTH profiles²⁾

A2DP (Advanced Audio Distribution Profile)

AVRCP (Audio Video Remote Control Profile)

Supported Codecs³⁾

SBC⁴⁾, AAC⁵⁾, LDAC

Transmission range (A2DP)

20 Hz - 40,000 Hz (LDAC sampling frequency 96 kHz with 990 kbps transmission)

20 Hz - 20,000 Hz (Sampling frequency 44.1 kHz)

- 1) The actual range will vary depending on factors such as obstacles between devices, magnetic fields around a microwave oven, static electricity, cordless phone use, reception sensitivity, the operating system, software applications, etc.
- 2) BLUETOOTH standard profiles indicate the purpose of BLUETOOTH communication between devices.
- 3) Codec: Audio signal compression and conversion format
- 4) Abbreviation for Subband Codec
- 5) Abbreviation for Advanced Audio Coding

Front L/Front R/Center speaker block section

Speaker

46 mm × 93 mm cone type

Speaker system

Acoustic suspension

Built-in subwoofer section

Speaker

45 mm × 108 mm cone type

Speaker system

Bass reflex

General

Power requirements

220 V - 240 V AC, 50 Hz/60 Hz

Power consumption

On: 50 W

Network standby mode ([Network/Bluetooth Standby] is set to [On]):

Less than 3 W

Standby mode ([Network/Bluetooth Standby] is set to [Off]):

Less than 0.5 W

The Wi-Fi port of the speaker system have a router function which can forward audio data to another Sony audio product.

Dimensions* (approx.) (w/h/d)

950 mm × 64 mm × 128 mm

* Not including projection portion

Mass (approx.)

4.6 kg

Devices you can stream audio from

- iPhone, iPad, or iPod touch with iOS 11.4 or later
- Apple TV 4K or Apple TV HD with tvOS11.4 or later
- HomePod with iOS 11.4 or later
- Mac with either iTunes 12.8 or later or macOS Catalina
- PC with iTunes 12.8 or later

Wireless Transmitter/ Receiver Section

Communication system

Wireless Sound Specification version

4.0

Frequency band

5 GHz

Modulation method

OFDM

Supplied Accessories

- Remote control (1)
- Battery (2)
- WALL MOUNT TEMPLATE (1)
- HDMI cable (supports the specification equal to High Speed HDMI Cable with Ethernet) (1)
- TV center speaker mode cable (1)
- AC power cord (mains lead) (1)
- Startup Guide
- Operating Instructions (this document)

Design and specifications are subject to change without notice.

Radio Frequency Bands and Maximum Output Power

	Frequency band	Maximum output power
BLUETOOTH	2400 - 2483.5 MHz	< 9.9 dBm
Wireless LAN	2400 - 2483.5 MHz	< 19.9 dBm
	5150 - 5250 MHz	< 19.8 dBm
	5250 - 5350 MHz	< 19.8 dBm
	5470 - 5725 MHz	< 19.8 dBm
	5725 - 5850 MHz	< 13.96 dBm
Wireless Speaker	5150 - 5250 MHz	< 16 dBm
	5250 - 5350 MHz	< 16 dBm
	5470 - 5600 MHz	< 16 dBm
	5650 - 5725 MHz	< 16 dBm
	5725 - 5850 MHz	< 13.9 dBm

Playable Types of Audio Files

Codec	Extension
MP3 (MPEG-1 Audio Layer III)	.mp3
AAC/HE-AAC	.m4a, .aac, .mp4, .3gp
WMA9 Standard	.wma
LPCM	.wav
FLAC	.flac
DSF	.dsf
DSDIFF*	.dff
AIFF	.aiff, .aif
ALAC	.m4a
Vorbis	.ogg
Monkey's Audio	.ape

* The speaker system does not play DST encoded files.

Notes

- Some files may not play depending on the file format, file encoding, recording condition, or other conditions.
- Some files edited on a PC may not play.
- Fast forward or fast reverse may not be available with some files.
- The speaker system does not play coded files such as DRM.
- The speaker system cannot recognize a file/folder depending on the name/meta-data.
- Some USB devices may not work with this speaker system.
- The speaker system can recognize Mass Storage Class (MSC) devices (such as flash memory).

Supported Input Audio Formats

Supported audio formats differ depending on the input setting of the speaker system. "O" indicates the supported audio format and "-" indicates the unsupported audio format in the table below.

Format	TV input (eARC)	TV input (ARC)	TV input (OPT)
LPCM 2ch	O	O	O
LPCM 5.1ch	O	-	-
LPCM 7.1ch	O	-	-
Dolby Digital	O	O	O
Dolby TrueHD	O	-	-
Dolby Digital Plus	O	O	-
Dolby Atmos	O	-	-
Dolby Atmos - Dolby TrueHD	O	-	-
Dolby Atmos - Dolby Digital Plus	O	O	-
DTS	O	O	O
DTS-ES Discrete 6.1, DTS-ES Matrix 6.1	O	O	O
DTS 96/24	O	O	O
DTS-HD High Resolution Audio	O	-	-
DTS-HD Master Audio	O	-	-
DTS:X	O	-	-

On BLUETOOTH Communication

- BLUETOOTH devices should be used within approximately 10 meters (33 feet) (unobstructed distance) of each other. The effective communication range may become shorter under the following conditions.
 - When a person, metal object, wall or other obstruction is between the devices with a BLUETOOTH connection
 - Locations where a wireless LAN is installed
 - Around microwave ovens that are in use
 - Locations where other electromagnetic waves occur
- BLUETOOTH devices and wireless LAN (IEEE 802.11 b/g/n) use the same frequency band (2.4 GHz). When using your BLUETOOTH device near a device with wireless LAN capability, electromagnetic interference may occur. This could result in lower data transfer rates, noise, or inability to connect. If this happens, try the following remedies:
 - Use this speaker system at least 10 meters (33 feet) away from the wireless LAN device.
 - Turn off the power to the wireless LAN device when using your BLUETOOTH device within 10 meters (33 feet).
 - Install this speaker system and BLUETOOTH device as close to each other as possible.
- The radio waves broadcast by this speaker system may interfere with the operation of some medical devices. Since this interference may result in malfunction, always turn off the power on this speaker system and BLUETOOTH device in the following locations:
 - In hospitals, on trains, in airplanes, at gas stations, and any place where flammable gasses may be present
 - Near automatic doors or fire alarms
- This speaker system supports security functions that comply with the BLUETOOTH specification to ensure secure connection during communication using BLUETOOTH technology. However,

this security may be insufficient depending on the setting content and other factors, so always be careful when performing communication using BLUETOOTH technology.

- Sony cannot be held liable in any way for damages or other loss resulting from information leaks during communication using BLUETOOTH technology.
- BLUETOOTH communication is not necessarily guaranteed with all BLUETOOTH devices that have the same profile as this speaker system.
- BLUETOOTH devices connected with this speaker system must comply with the BLUETOOTH specification prescribed by the Bluetooth SIG, Inc., and must be certified to comply. However, even when a device complies with the BLUETOOTH specification, there may be cases where the characteristics or specifications of the BLUETOOTH device make it impossible to connect, or may result in different control methods, display or operation.
- Noise may occur or the audio may cut off depending on the BLUETOOTH device connected with this speaker system, the communications environment, or surrounding conditions.

If you have any questions or problems concerning your speaker system, please consult your nearest Sony dealer.

Precautions

On safety

- Should any solid object or liquid fall into the speaker system, unplug the speaker system and have it checked by qualified personnel before operating it any further.
- Do not climb on the speaker system, as you may fall down and injure yourself, or speaker system damage may result.

On power sources

- Before operating the speaker system, check that the operating voltage is identical to your local power supply. The operating voltage is indicated on the nameplate on the bottom of the bar speaker.
- If you are not going to use the speaker system for a long time, be sure to disconnect the speaker system from the wall outlet (mains). To disconnect the AC power cord (mains lead), grasp the plug itself; never pull the cord.
- One blade of the plug is wider than the other for the purpose of safety and will fit into the wall outlet (mains) only one way. If you are unable to insert the plug fully into the outlet, contact your dealer.
- AC power cord (mains lead) must be changed only at a qualified service shop.

On heat buildup

Although the speaker system heats up during operation, this is not a malfunction. If you continuously use this speaker system at high volume, the speaker system temperature at the rear and bottom rises considerably. To avoid burning yourself, do not touch the speaker system.

On placement

- Do not place the speaker system near heat sources or in a place subject to direct sunlight, excessive dust, or mechanical shock.
- Do not place anything at the rear of the speaker system that might block the ventilation holes and cause malfunctions.

- Do not place metal objects other than a TV around the speaker system. Wireless functions may be unstable.
- If the speaker system is being used in combination with a TV, VCR, or tape deck, noise may result and picture quality may suffer. In such a case, place the speaker system away from the TV, VCR, or tape deck.
- Use caution when placing the speaker system on a surface that has been specially treated (with wax, oil, polish, etc.), as staining or discoloration of the surface may result.
- Take care to avoid any possible injury from the corners of the speaker system.
- Keep 3 cm (1 3/16 in) or more space under the speaker system when you hang it on a wall.
- The speakers of this speaker system are not of magnetically shielded type. Do not place magnetic cards on the speaker system or near it.

On operation

Before connecting other devices, be sure to turn off and unplug the speaker system.

If you encounter color irregularity on a nearby TV screen

Color irregularities may be observed on certain types of TV sets.

If color irregularity is observed...

Turn off the TV set, then turn it on again after 15 to 30 minutes.

If color irregularity is observed again...

Place the speaker system further away from the TV set.

On cleaning

Clean the speaker system with a soft, dry cloth. Do not use any type of abrasive pad, scouring powder, or solvent such as alcohol or benzine.

If you have any question or problem concerning your speaker system, please consult your nearest Sony dealer.

Disclaimer regarding services offered by third parties

Network services, content and the (operating system and) software of this product may be subject to individual terms and conditions and changed, interrupted or discontinued at any time and may require fees, registration and credit card information.

Notes on updating

This speaker system allows you to update the software automatically when connected to the Internet via a wireless network.

You can add new features and use the speaker system with more convenience and safety by updating the speaker system. If you do not want to update automatically, you can disable the function by using Sony | Music Center installed on your smartphone or tablet. However, the speaker system may update the software automatically for reasons such as safety, even if this function is disabled. You can also update the software using the settings menu when this function is disabled. For details, refer to Help Guide. You may not use the speaker system while the software is being updated.

Copyrights and Trademarks

This speaker system incorporates Dolby® Digital and the DTS® Digital Surround System.

* Dolby, Dolby Atmos, and the double-D symbol are registered trademarks of Dolby Laboratories Licensing Corporation. Manufactured under license from Dolby Laboratories. Confidential unpublished works. Copyright © 2012–2022 Dolby Laboratories. All rights reserved.

**For DTS patents, see <http://patents.dts.com>. Manufactured under license from DTS, Inc. DTS, DTS:X, and the DTS:X logo are registered trademarks or trademarks of DTS, Inc. in the United States and other countries. © 2022 DTS, Inc. ALL RIGHTS RESERVED.

The Bluetooth® word mark and logos are registered trademarks owned by Bluetooth SIG, Inc. and any use of such marks by Sony Group Corporation and its subsidiaries is under license.

The terms HDMI™, HDMI High-Definition Multimedia Interface, and the HDMI Logo are trademarks or registered trademarks of HDMI Licensing Administrator, Inc.

Google, Google Play, Google Home and Chromecast built-in are trademarks of Google LLC. Google Assistant is not available in certain languages and countries.

Apple, AirPlay, iPad, iPhone and iPod touch are trademarks of Apple Inc., registered in the U.S. and other countries.

Use of the Works with Apple badge means that an accessory has been designed to work specifically with the technology identified in the badge and has been certified by the developer to meet Apple performance standards.

"BRAVIA" logo is a trademark of Sony Corporation.

WALKMAN® and WALKMAN® logo are registered trademarks of Sony Corporation.

"PlayStation" is a registered trademark or trademark of Sony Interactive Entertainment Inc.

MPEG Layer-3 audio coding technology and patents licensed from Fraunhofer IIS and Thomson.

Windows Media is either a registered trademark or trademark of Microsoft Corporation in the United States and/or other countries.

This product is protected by certain intellectual property rights of Microsoft Corporation. Use or distribution of such technology outside of this product is prohibited without a license from Microsoft or an authorized Microsoft subsidiary.

Wi-Fi®, Wi-Fi Protected Access® and Wi-Fi Alliance® are registered trademarks of Wi-Fi Alliance.

Wi-Fi CERTIFIED™, WPA™, and WPA2™ are trademarks of Wi-Fi Alliance.

LDAC™ and LDAC logo are trademarks of Sony Corporation.

LDAC is an audio coding technology developed by Sony that enables the transmission of High-Resolution (Hi-Res) Audio content, even over a Bluetooth connection. Unlike other Bluetooth compatible coding technologies such as SBC, it operates without any down-conversion of the Hi-Res Audio content*, and allows approximately three times more data** than those other technologies to be transmitted over a Bluetooth wireless network with unprecedented sound quality, by means of efficient coding and optimized packetization.

* excluding DSD format contents

**in comparison with SBC (Subband Coding) when the bitrate of 990 kbps (96/

48 kHz) or 909 kbps (88.2/44.1 kHz) is selected

This product contains software that is subject to the GNU General Public License ("GPL") or GNU Lesser General Public License ("LGPL"). These establish that customers have the right to acquire, modify, and redistribute the source code of said software in accordance with the terms of the GPL or the LGPL.

For details of the GPL, LGPL and other software licenses, please refer to [Software License Information] under  [Setup] - [Advanced Settings] - [System Settings] on the product.

You may find a copy of the relevant source code as required under the GPL/LGPL (and other licenses) at the following URL.

You may obtain the source code as required by the GPL/LGPL on a physical medium from us for a period of three years after our last shipment of this product by applying through the form at the following URL.

This offer is valid to anyone in receipt of this information.

<https://oss.sony.net/Products/Linux/>

Please note that Sony cannot answer or respond to any inquiries regarding the content of this source code.

"TRILUMINOS" and "TRILUMINOS" logo are a registered trademark of Sony Corporation.

The Spotify Software is subject to third party licenses found here:
<https://www.spotify.com/connect/third-party-licenses>.

Spotify and Spotify logos are trademarks of the Spotify Group.*

* Depending on the country and region, this function may not be available.

All other trademarks are trademarks of their respective owners.

Index

Buttons

AUDIO 36
BLUETOOTH 26
DIMMER 40
NIGHT 35
SOUND FIELD 34
VOICE 35

A

ARC 11
Audio files 56
Audio format 57
Audio Return Channel 11

B

BLUETOOTH
 Function 26
 Pairing 26
"BRAVIA" Sync 39

C

Connection
 See "Wired connection" or "Wireless connection"
Control for HDMI 38

D

DTS Dialog control 37

E

eARC 11
Easy Setup 41
Enhanced Audio Return Channel 11

I

Installation 15

M

Multiplex broadcast sound 36

N

Night mode 35

P

PRTCT 51

R

Remote control 12
Resetting 52

S

Settings
 Resetting 52
 Setting item 42
Software update 43
Sound Field 34

U

USB device 28

V

Voice mode 35
Volume 33

W

Wall mount 15
Wired connection
 TV 17
 USB device 28
Wireless connection
 BLUETOOTH devices 26
 Headphones 29
 TV 24

The software of this system may be updated in the future. To find out details on any available updates, please visit the following URL.

- For customers in Europe
<https://www.sony.eu/support>
- For customers in Asia-Pacific
<https://www.sony-asia.com/support>

dts x

Dolby Atmos

LDAC

 Chromecast built-in

HDMI™



* 5 0 3 4 4 9 0 1 3 * (1)