

# INSTRUCTION MANUAL



## FSP200 & 915FS Optical Fiber Fusion Splicer



Read and understand all of the instructions and safety information in this manual before operating or servicing this tool.

# Table of Contents

Preface	3
Important Safety Information	4
Section 1. Identification	9
Section 2. Operation	11
Setup .....	11
Splice Mode.....	12
Fiber Preparation .....	13
Splicing Procedure.....	14
Heating Protection Sleeve .....	15
Cooling Tray .....	16
Splice-on Connectors .....	16
Button Functions.....	17
Appendixes .....	17
Section 3. Menu Operation	18
Splice Mode Menu (S-Mode) .....	18
Heater Mode Menu (H-Mode) .....	22
Maintenance.....	24
Splice Set .....	25
Data Save .....	26
Set .....	27
Section 4. Specifications	29
Section 5. Troubleshooting	30
Appendix A. FSP200 Fusion Splicer Cleaning	35
Appendix B. Practice Splicing	38
Appendix C. Tempo Communications Splice-on Connectors	39

## Preface

### FSP200 Description

The Tempo Communications FSP200 Optical Fiber Fusion Splicer is intended to fuse fibers, resulting in low splice loss and long-term stable splices. Splice loss depends on certain conditions such as fiber preparation, splicing parameters, and fiber condition.

The FSP200 fusion splicer uses a CDS (Core Detection System), which is also widely known as PAS (Profile Alignment System). Two cameras sense the center of the core of the fibers, with the fusion splicer then adjusting in the X, Y, and Z dimensions to automatically and precisely align the two fiber cores. A fusing arc is applied, which then provides the lowest loss fusion splice. The FSP200 with PAS technology is designed for splicing many types of optical fibers. It is small in size and lightweight, making it suitable for any operating environment. It is easy to operate, and it splices fast while maintaining low splice loss.

### 915FS Description

The Tempo Communications 915FS Optical Fiber Fusion Splicer is intended to fuse fibers, resulting in low splice loss and long-term stable splices. Splice loss depends on certain conditions such as fiber preparation, splicing parameters, and fiber condition.

The 915FS fusion splicer uses an active cladding alignment technology in which alignment of the fiber is performed in all three axis. This allows the technician to complete fusion splices with low splice losses as with core alignment splicers and far surpassing the performance of V-Groove splicers.

The 915FS is perfectly suited for all FTT(x) and P2P applications.

#### Contents List

- Fusion splicer
- 250 micron adapter pair
- 900 micron adapter pair
- SOC Oven adapter
- Spare electrodes (one pair)
- AC adapter (power supply) with North American line cord
- Battery pack (installed)
- Carry case with strap
- 1.5 mm hex wrench
- Plastic tweezers
- Cooling tray
- Electrode polisher with 10 polishing strips
- Cleaning brush
- USB Cable
- Quick reference card
- Shipping contents form

## Safety

Safety is essential in the use and maintenance of Tempo Communications tools and equipment.

This instruction manual and any markings on the tool provide information for avoiding hazards and unsafe practices related to the use of this tool. Observe all of the safety information provided.

## Purpose of This Manual

Keep this manual available to all personnel.

All specifications are nominal and may change as design improvements occur. Tempo Communications shall not be liable for damages resulting from misapplication or misuse of its products.

# Important Safety Information

## General

Use this unit for the manufacturer’s intended purpose only, as described in this manual. Any other use can impair the protection provided by the unit. Do not use the splicer on live fibers.

## Environmental Conditions

This tool is designed to operate at a maximum relative humidity of 95% and at altitudes up to 5000 m (16,400 ft).

## Before Applying Power

Verify that the tool is set to match the available line voltage.

## Do Not Operate in Explosive Atmosphere

Do not operate the tool in the presence of flammable gases or fumes.

## Do Not Remove Instrument Cover

Do not remove the cover of the unit for any reason. It contains no user-serviceable parts.

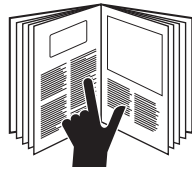

## SAFETY ALERT SYMBOL

This symbol is used to call your attention to hazards or unsafe practices which could result in an injury or property damage. The signal word, defined below, indicates the severity of the hazard. The message after the signal word provides information for preventing or avoiding the hazard.

### **⚠ DANGER**

Immediate hazards which, if not avoided, WILL result in severe injury or death.

### **⚠ WARNING**

Hazards which, if not avoided, COULD result in severe injury or death.

### **⚠ CAUTION**

Hazards or unsafe practices which, if not avoided, MAY result in injury or property damage.



### **⚠ WARNING**

Read and understand all of the instructions and safety information in this manual before operating or servicing this tool.

Failure to observe this warning could result in severe injury or death.

## Important Safety Information (cont'd)

	<b>⚠ WARNING</b>
	<p>Electric shock hazard: Contact with live circuits could result in severe injury or death.</p>

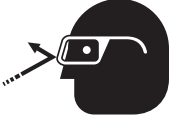
	<b>⚠ WARNING</b>
	<p>Wear eye protection when using this tool. Fiber fragments can be extremely dangerous if they come into contacts with eyes or skin or are ingested.</p>

<b>⚠ WARNING</b>
<p>Disconnect AC power cord from AC adapter inlet or wall socket (outlet) immediately if user observes the following or if the splicer receives the following faults:</p> <ul style="list-style-type: none"> <li>• Fumes, bad odor, noise, or overheat occurs.</li> <li>• Liquid or foreign matter falls into cabinet.</li> <li>• Splicer is damaged or dropped.</li> </ul> <p>If these faults occur, return unit to Tempo Communications service center for repair. Leaving splicer in a damaged state could cause equipment failure, electric shock or fire, and could result in severe injury or death.</p>

<b>⚠ WARNING</b>
<p>Electric shock hazard:</p> <ul style="list-style-type: none"> <li>• Use only AC adapter or battery charger designed for this splicer. Using an improper AC power source could cause fuming, electric shock, or equipment damage.</li> <li>• Do not disassemble or modify splicer, AC adapter, or battery. Do not remove or bypass any electrical or mechanical device (e.g., fuse or safety switch) incorporated into design and manufacturing of this equipment.</li> <li>• Never operate tool in an environment where flammable liquids or vapors exist. Risk of fire or explosion could result from the tool's electrical arc in such an environment.</li> <li>• Do not use compressed gas or canned air to clean tool. They may contain flammable materials that could ignite during electrical discharge.</li> <li>• Do not touch electrodes when splicer is on and power is supplied to unit. The electrodes generate high voltage and high temperatures that could cause a severe shock or burn.</li> <li>• Turn tool off and disconnect AC power cord before replacing electrodes.</li> </ul> <p>Failure to observe these warnings could result in severe injury or death.</p>

## Important Safety Information (cont'd)

### **⚠ WARNING**

Electric shock hazard: Use only proper power source.

- Check AC power source before use. Proper AC power source is 100–240 VAC, 50–60 Hz. Proper DC power source is 10–12 VDC. Improper AC or DC power source could cause fuming, electric shock, or equipment damage.
- AC generators commonly produce abnormally high AC output voltage or irregular frequencies. Measure output AC voltage with a circuit tester before connecting the AC power cord. Such abnormally high voltage or frequency from a generator could cause fuming, electric shock, or equipment damage. Make sure generator is regularly checked and serviced.

Failure to observe these warnings could result in severe injury or death.

### **⚠ WARNING**

Electric shock hazard:

- Do not modify, abuse, heat, or excessively pull on power cord. Use of a damaged cord could cause fuming, electric shock, or equipment damage.
- This tool uses a three-prong (core) AC power cord that contains an earthed ground safety mechanism. This tool must be grounded. Use only the supplied power cord. Never use a two-prong (core) power cord, extension cord, or plug.
- Connect AC power cord properly to splicer (inlet) and wall socket (outlet). When inserting AC plug, make sure there is no dust or dirt on terminals. Engage by pressing the female plug into the splicer (inlet) and the male plug into the wall socket (outlet) until both plugs are fully seated. Incomplete engagement could cause fuming, electric shock, or equipment damage.
- Do not short-circuit the terminals of AC adapter and optional battery. Excessive electrical current could cause fuming, electric shock, or equipment damage.
- Do not touch the splicer, AC power cord, and AC plugs with wet hands.
- Do not operate splicer near hot objects, in hot temperature environments, in dusty/humid atmospheres or when condensation is present on the tool. This may result in electric shock, splicer malfunction, or poor splicing performance.

Failure to observe these warnings could result in severe injury or death.

## Important Safety Information (cont'd)

### **⚠ CAUTION**

Battery safety:

- Do not allow anything to contact the battery terminals.
- Do not immerse batteries in liquid. Liquid may create a short circuit and damage the battery. If batteries are immersed, contact your service center for proper handling.
- Do not place the battery into a pocket, tool pouch, or tool box with conductive objects. Conductive objects may create a short circuit and damage the battery.
- Do not place a battery on moist ground or grass. Moisture may create a short circuit and damage the battery.
- Do not store the battery at more than 122 °F (50 °C) or less than -4 °F (-20 °C). Damage to the battery can result.
- Do not use another manufacturer's charger. Other manufacturers' chargers may overcharge and damage the battery.
- Do not attempt to open the battery. It contains no user-serviceable parts.

Failure to observe these precautions may result in injury and may damage the unit.

### **⚠ CAUTION**

- Do not store tool in areas of extremely high temperature and humidity.
- Do not touch protection sleeve or tube heater during or immediately after heating. These surfaces are very hot and touching them may result in burns.
- Do not place tool in an unstable or unbalanced position. Tool may shift or lose balance, causing unit to fall.
- This tool is precision adjusted and aligned. Do not allow unit to receive a strong shock or impact. Use supplied carrying case for transportation and storage. Carrying case protects tool from damage, moisture, vibration, and shock.

Failure to observe these precautions may result in injury and may damage the unit.

### **⚠ CAUTION**

Follow these instructions for handling electrodes:

- Use only specified electrodes.
- Set new electrodes in correct position.
- Replace electrodes as a pair.

Failure to observe this precaution may cause abnormal arc discharge, which may result in equipment damage or degradation in splicing performance.

## Important Safety Information (cont'd)

### **⚠ CAUTION**

- Do not use any chemical other than pure alcohol (99% or greater) to clean the objective lens, V-groove, LCD monitor, etc. Use of other chemicals may cause blurring, discoloration, damage, or deterioration.
- This tool requires no lubrication. Oil or grease may degrade the splicing performance and damage the splicer.
- This equipment must be repaired or adjusted by a qualified technician or engineer. Incorrect repair may cause fire or electric shock. Contact Tempo service center for repair.

Failure to observe these precautions may result in injury and may damage the unit.

## Section 1. Identification

### Components of Splicer

USB Port: Used to download the splice report and to upload new firmware for upgrade and revisions.

DC Output Port: Provides a 12V DC output at 1.5A.

DC Input Port: Provides connection for the power supply or external power cord.

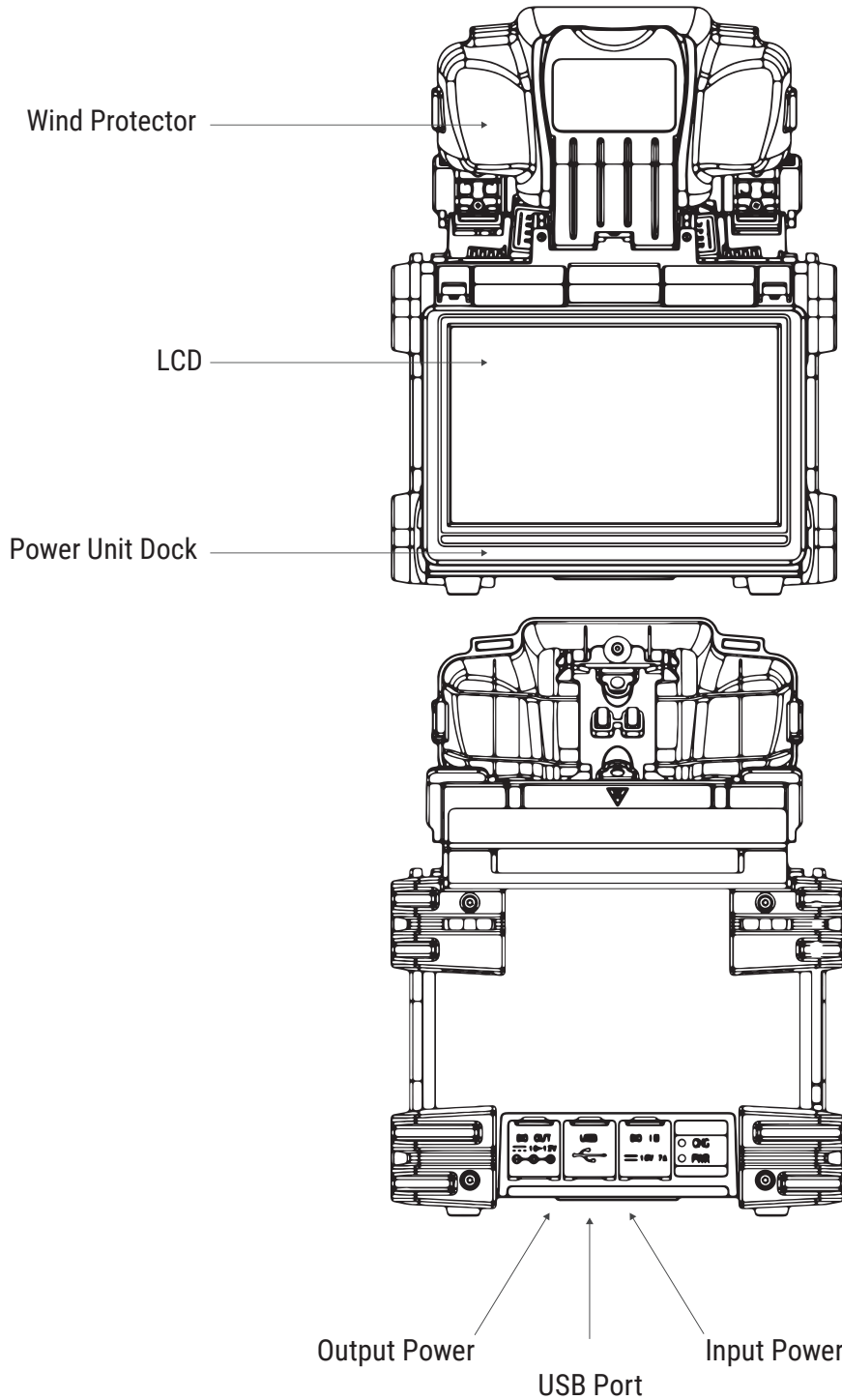

**Top View**

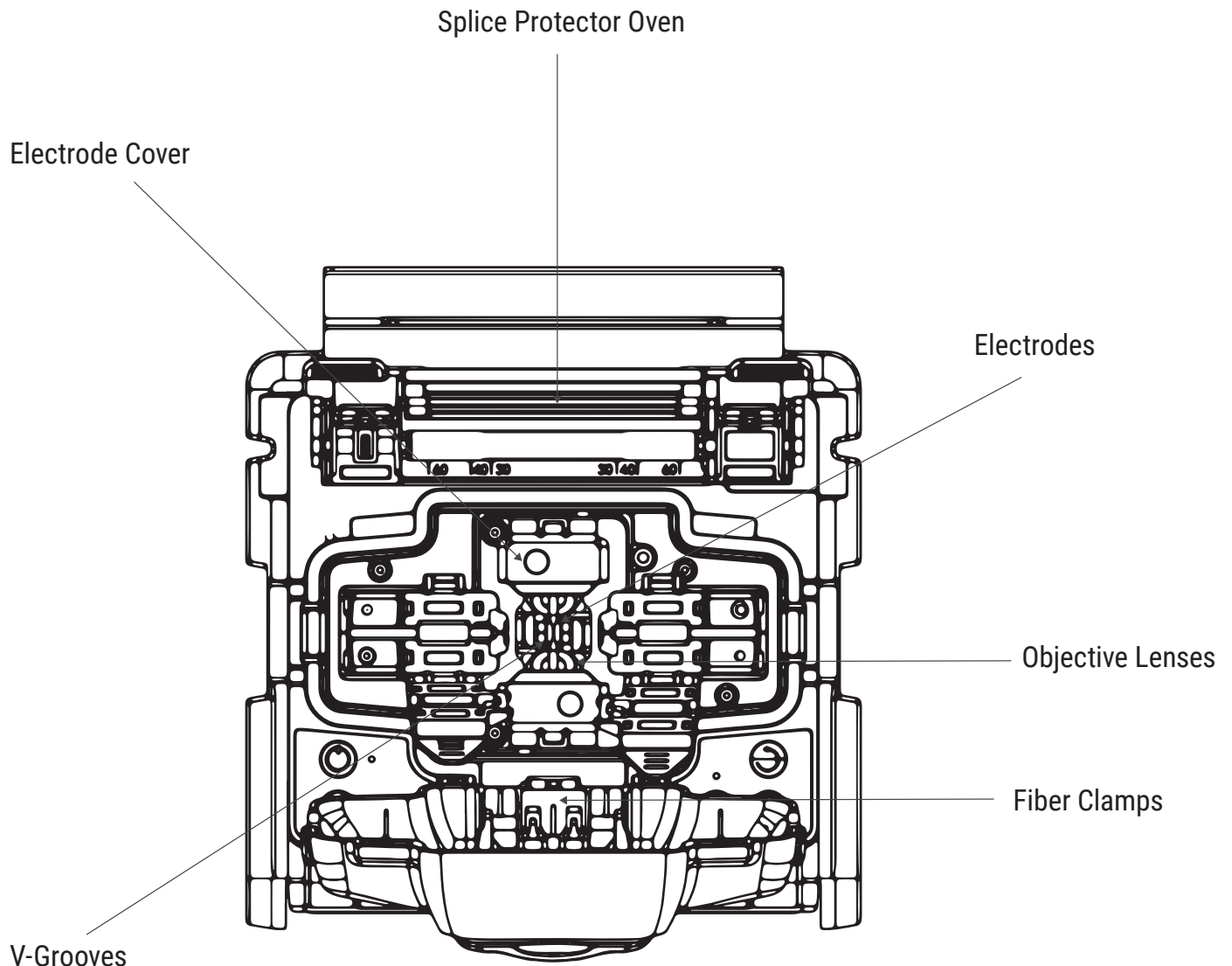

## Section 2. Operation

### Setup

#### Installing Battery in Splicer

The fusion splicer can be powered by an external power adapter and or the battery.

#### Inserting the Battery

Remove the protective cover from the battery contacts. Insert the battery into the battery compartment until it clicks into place.

#### Removing the Battery

Turn off the splicer. Push the release button, located on the side of the splicer body, and remove the battery.

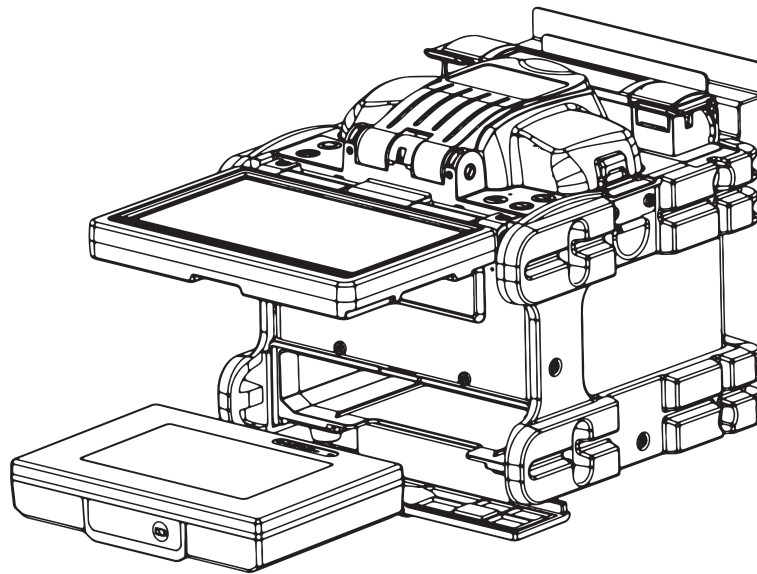

#### Two Methods of Checking Remaining Battery Capacity

- If the battery is already installed in the splicer, turn the splicer ON. The battery is automatically identified, and the remaining battery capacity is displayed on the “Ready” screen.
- Press the battery check button on the battery pack. The remaining battery capacity is indicated on the LED indicator.

Remaining battery capacity indicator	Remaining battery
5 LED	80~100%
4 LED	60~80%
3 LED	40~60%
2 LED	20~40%
1 LED	Less than 10%

## Turning Splicer ON

Press and hold  until the LED on the keypad turns ON (green color).

The "Ready" screen is displayed after all the motors reset to their initial positions.

The power source type is automatically identified. If the battery is used, the remaining battery capacity is displayed.

## Splice Mode

Use SM FAST splice mode for standard SM fiber (ITU-TG.652) splicing. It performs splices in 7 seconds and is the quickest mode for SM fiber splicing.

Use AUTO splice mode if fiber type is not identified. Splice takes 2 seconds longer but it covers most conventional fiber splicing for the following reasons:

- AUTO mode first identifies fiber type by analyzing fiber profile, and the splicing condition is chosen for the type of fiber. The types of fibers covered by AUTO are all the conventional fibers, such as SMF (G652), BIF (G657), NZDSF (G655), MMF (G651), etc. AUTO mode takes longer than the SM processes but is recommended in cases where the fiber type is not positively identified or if the user is new to fusion splicing.
- AUTO mode uses an automatic arc calibration function, which monitors the splicing process and ensures adequate arc power for the splice.

### Automatic Arc Calibration Function

When the automatic ARC calibration function is enabled the previous splice's ARC power is used. If the ambient conditions or type of fiber has changed an ARC calibration may be required. The automatic arc calibration function works in AUTO modes only. It is not active in the standard splice modes. When using those modes, performing arc calibration before splicing is strongly recommended.

## Fiber Preparation

### Placing Protection Sleeve over Fiber

Place the protection sleeve over the fiber. Clean optical fiber with alcohol-soaked gauze or lint-free tissue approximately 100 mm (4 in) from the tip.

Note: Splice-on connectors are pre-cleaved. Do not attempt to clean the fiber on the splice-on connector. Follow the instructions supplied with the splice-on connectors.

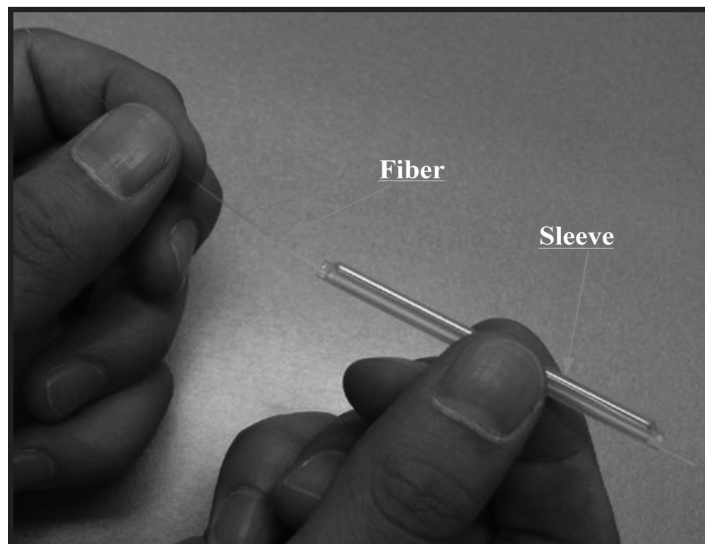

### ⚠ CAUTION

- Clean optical fiber with alcohol-soaked gauze or lint-free tissue. Dust particulates can enter the protection sleeve, resulting in a fiber break or attenuation increase.
- Make sure fiber is passed through the protection sleeve.
- When protection sleeve core tube is longer than the length of outer sheath, cut off excess sleeve to avoid micro bend after heating.

### Stripping and Cleaning Fiber

Use the supplied fiber stripping tool to strip the outer coating 30 to 40 mm (1.25 to 1.5 in) from its tip. Thoroughly clean the fiber with alcohol-soaked (99% or greater) gauze or lint-free tissue.

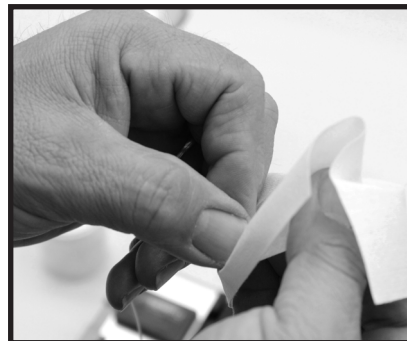

### Fiber Cleaving

Do not let the fiber end-face touch anything. Place the fiber into the universal adapter, and insert the adapter into the FCL200 or 915CL or 920CL. Follow the instructions for the FCL200 or 915CL or 920CL to cleave the fiber.

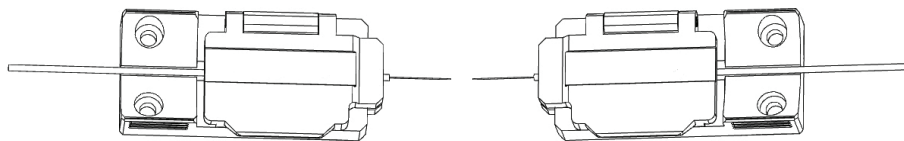

### Loading Fiber into Splicer

1. Open the wind protector and install the fiber adapters into the splicer, making sure the fiber is positioned into the center of the V-grooves.
2. Close the wind protector.

### Splicing Procedure

To ensure a good splice, the optical fiber is observed with the image processing system equipped in the FSP200 or 915FS. However, in some cases the image processing system cannot detect a faulty splice. Visual inspection with the monitor is often necessary for better splicing yield. Observe the following standard operating procedure:

- After fibers are loaded into the splicer, press **O** and the fibers will move toward each other. The fiber motion stops and the cleaning arc is performed. The cleave angle and end-face quality are checked. If the measured cleave angle is greater than its set threshold or fiber chipping is detected, the beeper sounds and an error message warns the operator. The splicing procedure pauses. If no error message is displayed, the below stated end-face conditions are used for visual

inspection. If observed, remove the fiber from the splicer and repeat fiber preparation. These fiber cleave defects may cause a faulty splice.

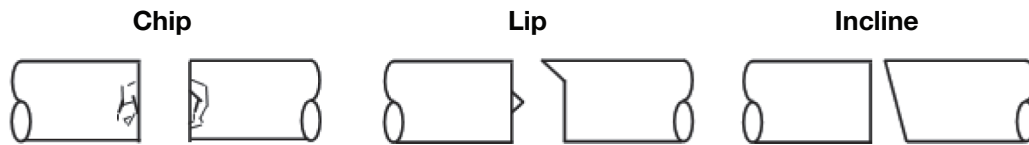

- After fiber inspection, the fibers are aligned core-to-core or cladding-to-cladding. Cladding axis offset and core axis offset measurements can be displayed.
- After completion of fiber alignment, an arc discharge is performed to splice the fibers.
- Estimated splice loss is displayed upon completion of splicing. Splice loss is affected by factors stated in Section 5. These factors are taken into account to calculate, or estimate, splice loss. The calculation is based on dimensional parameters, such as MFD, cleave quality, and fusion splice shape after the splice. If either the cleave angle measured or the estimated splice loss exceeds its set threshold, an error message is displayed. If the spliced fiber is detected as abnormal, such as “Fat”, “Thin” or “Bubble”, an error message is displayed. If no error message is displayed but the splice looks poor by visual inspection through the monitor, it is strongly recommended to resplice.

#### Notes:

- Splice point sometimes looks a bit fatter than other parts. This is considered a normal splice and does not affect splice loss.
- To change threshold for estimated splice loss or cleave angle, refer to “Splice Mode” in this manual for details.
- Splice loss may be improved in some cases by additional arc discharges. Splice loss estimate and splice check are performed again. Splice loss may be worsened in some cases by additional arc discharges (re-arcs). Additional arc discharge can be set to “disabled”, or limited to the number of additional arcs.
- Splicing result is automatically saved in splicer memory.

### Arc Calibration

When a splicing session is first started or if the splicing environment has changed, it is recommended that the technician perform an arc calibration.

1. Navigate to the “Maintenance” menu and select “Arc Calibration.”
2. Place cleaved fibers into the splicer.
3. Follow the on-screen prompts until ARC OK message is displayed.

Note: Always use the same fiber as you are splicing for the ARC Calibration.

### Heating Protection Sleeve

1. Transfer the fiber with protection sleeve from the centering device to the tube heater.
2. Close the tube heater lid.

#### Notes:

- Make sure the splice point is located at the center of the protection sleeve.
  - Make sure the strength member in the protection sleeve is placed downward.
  - Make sure the fiber is not distorted.
  - The splice-on connector must be installed on the right-hand side of the splicer heater. Follow the manufacturer's splice on connector instructions.
3. Press **↵** to start tube heating. The beeper sounds and the HEAT LED (red color) turns off when tube heating is completed.
  4. Open the tube heater lids and remove the protected fiber from the tube heater. Apply some tension to the fiber while removing it from the tube heater.
  5. Visually inspect the finished sleeve to verify that no bubbles or debris/dust is present in the sleeve.











## Cooling Tray

Place the splice into the cooling tray on the back of the FSP200 or 915FS splicer.



The Tempo fusion splicers are compatible with various splice on connectors available in the market. The appropriate adapter is available as an optional item as listed on the datasheet. The splice on connector adapter is loaded into the righthand side of the splicer.

## Button Functions

Button	Description
	Turns the splicer ON/OFF
	Enter key
	Return/Exit key
	Main Menu
	On-Board Instruction Manual
	Screen Capture
	LCD Brightness
	Start/Stop heating protection
	Re ARC
	Resets the motor position
	Starts splicing work

## Appendixes

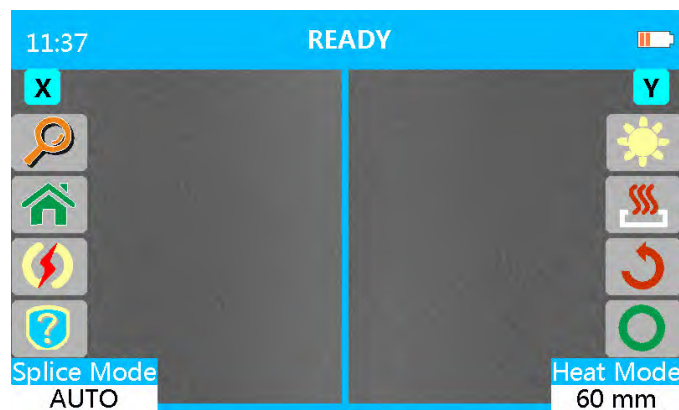

Refer to the following appendixes at the end of this manual for additional operating information:

- Appendix A—Fusion Splicer Cleaning
- Appendix B—Practice Splicing

## Section 3. Menu Operation

Press  to enter the splicer menu. There are six main menus:

1. Splice Mode Menu (S-Mode)
2. Heater Mode Menu (H-Mode)
3. Maintenance
4. Splice Set
5. Data Save
6. Set

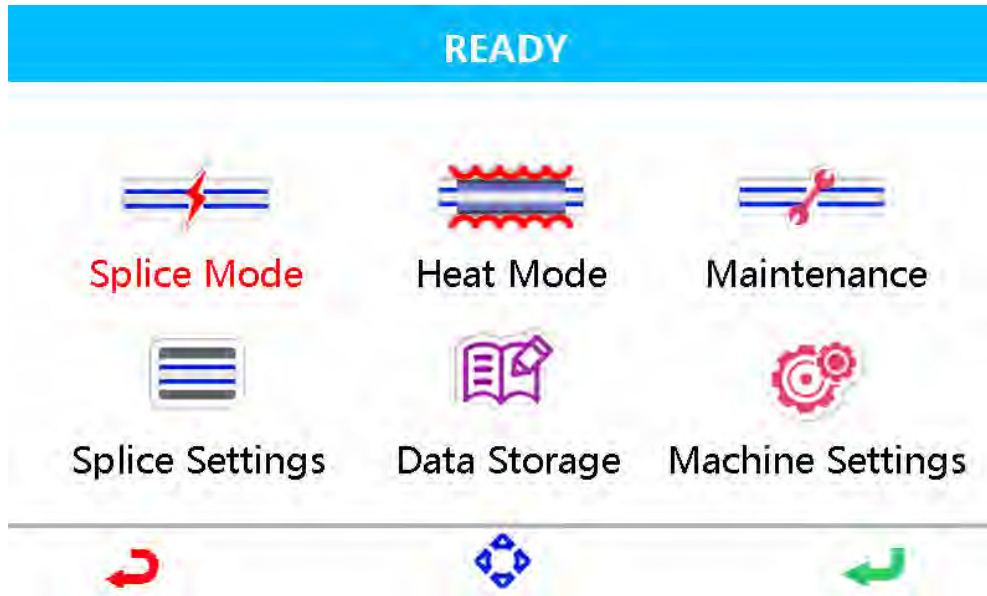

### Splice Mode Menu (S-Mode)

#### (1) Select Splice Mode

Select "S-Mode" to access the available splicing modes. Use the arrow keys to highlight the desired splicing mode.

Select an appropriate splice mode for the type of fiber to be spliced, and use the arrow keys to select the splice mode.

Note: "1 AUTO SM/NZ/DS/MM" mode is recommended for splicing in most cases. In this mode, the splicer automatically adjusts splice parameters according to the fiber type.

#### (2) Edit Splice Mode

Splicing parameters in each splice mode can be modified.

Use the arrow keys to select the parameter to be modified.  
Use the arrow keys to modify the parameter.

Note: In AUTO mode, certain parameters cannot be changed.

- Fiber Type
- Mode title 1
- Mode title 2
- Cleave limit
- Loss limit
- ARC1 power
- ARC1 time
- Cleaning ARC
- Rearc time

Parameter	Description
Arc2 Power	In SM/DS/MM/NZ/AUTO modes the arc power is fixed at 40 bits.
Arc2 Time	Arc time is fixed at 1500 ms for SM and DS modes, 2000 ms for NZ mode, and 3000 ms for MM mode. This is automatically set depending on the fiber type when AUTO mode is selected.

**Edit Mode for Splicing**

- Fiber Type: Select or enter the name of fiber being spliced.
- Mode Title1: Enter the name of the type of fiber.
- Mode Title2: Enter alternate name of fiber.
- Manual align: In manual mode the user can control the motors by hand.
- Proof Test: Enable or disable the tension test after splicing.
- Cleave Limit: Set or disable the cleave error limit in degrees.
- Loss Limit: Set the splice loss level in dB.
- Axis Offset Limit: Set or disable the axis offset error limit in degrees.
- Cleaning Arc: Set or disable the duration of the cleaning arc.
- Gap: Increase the gap if the fibers are “soft” and melt too easily. Decrease the gap if the fibers are “hard to melt”.
- Gap Set: Set the gap closer to the larger diameter core fiber when splicing dissimilar-sized fibers. This may also be necessary when splicing what the user may consider to be the same size fiber but the two fibers are from different manufacturers.
- Prefuse Power: Set or disable the power to the electrode during the initial fusing cycle.
- Prefuse Time: Set or disable the duration of the prefuse cycle.
- Overlap: Set or disable the overlap closer if the fibers are hard to splice or the core diameter is thick. (The harder the closer, the thicker the closer; the softer the farther, the thinner the farther.)
- Arc1 Power: Increase or decrease or disable the Arc1 power.
- Arc1 Time: Increase or decrease or disable the Arc1 duration.
- Arc2 Power: Increase or decrease or disable the Arc2 power.
- Arc2 Time: Increase or decrease or disable the Arc2 duration.
- Arc2 ON Time: Set or disable the Arc2’s working (arcing) duration.
- Arc2 OFF Time: Set or disable the Arc2’s off duration.
- Rearc Time: Set or disable the duration of the Rearc.

### Summary of electrode activation

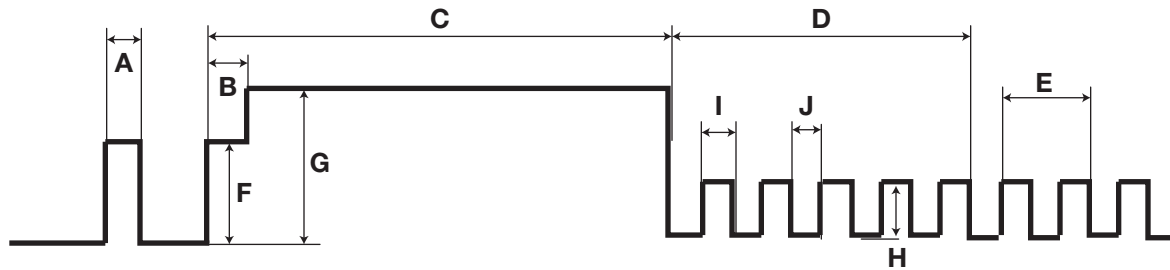

- A: Cleaning Arc
- B: Prefuse Time
- C: Arc1 Time
- D: Arc2 Time
- E: Rearc Time
- F: Prefuse Power
- G: Arc1 Power
- H: Arc2 Power
- I: Arc2 ON Time
- J: Arc2 OFF Time

Note: Not all settings are available in the AUTO modes.

This is a general guideline for the user to control the fusion settings. Every type of fiber has its own characteristics and properties that may require the manual setting of these parameters. The user will have to perform careful experiments with their individual fibers to obtain optimum results.

## Heater Mode Menu (H-Mode)

There are 30 user-programmable heating modes. Select the one most suitable for the protection sleeve used.

Each tube-heating mode is optimized for a type of protection sleeve. These modes can be found in the database area for reference. The operator can copy the one and paste it into the user-programmable area for customized protection sleeves.

### (1) Select Heater Mode

Select "H-Mode" to access the available heater modes. Use the arrow keys to highlight the desired heater mode.

Select the heater mode most suitable for the protection sleeve to be used.

### (2) Edit Heater Mode

Tube-heating conditions stored in heater mode can be edited or changed.

Editable parameters include Heat Time and Heat Temp (heating temperature). Heat Time will automatically adjust according to atmospheric conditions, e.g., ambient temperature. The actual Heat Time may vary from set Heat Time.

Sets Heating Temperature: Fiber coating may melt if Heat Temp is over 190 °C (374 °F).

Sets Finish Temp (Finish Temperature): When heater approaches this temperature, the buzzer beeps, announcing the sleeve is cooled down and is ready to be removed from the heater.

In "Select Heater Mode", use the right arrow key to enter the "Edit Heater Mode" menu.

## Edit Mode for Heater Settings

- Sleeve Type: Enter the protection sleeve name.
- Mode Title1: Enter the heater mode setting name.
- Mode Title2: Enter the alternate heater mode setting name.
- Heat Time: Enter the heater duration.
- Heater Control: Enter the splice protector size as Long, Mid or Micro.
- Center Heat Temp: Enter the center of the oven temperature.
- L-R Heat Temp: Enter the left- and right-hand sides oven temperature.
- Cool Time: Disable it when not needed. Also, to disable the beep. (The “beep” is activated when the “cool time” has been set as “x” seconds; there is no “beep” when the cool time has been set to zero seconds.)
- Heater Mode: Enter the mode as center and sides activated or center only activated.

## Maintenance

Routine maintenance can be performed on the fusion splicer.. In “Maintenance”, the operator can calibrate arc, set motor drive, calibrate motors, adjust screen, replace electrodes, and stabilize electrodes.

### Arc Calibration

When a splicing session is first started or if the splicing environment has changed, it is recommended that the technician perform an arc calibration.

1. Navigate to the “Maintenance” menu and select “Arc Calibration.”
2. Place cleaved fibers into the splicer.
3. Follow the on-screen prompts until ARC OK message is displayed.

Always use the same fiber as you are splicing for the ARC Calibration.

### Cleaning the Electrodes

It may be necessary to clean the electrodes if the ARC calibration fails or if the splicer is not splicing properly.

1. Turn splicer off. Remove battery and unplug from AC power.
2. Remove the electrodes and clean the electrodes using the electrode polisher.
3. Insert the electrode tip into the hole of the electrode polisher and gently rotate the electrode.
4. Wipe the electrodes with 99% pure IPA. Do not touch the electrode surface with your fingers. Now is a good time to clean the objective lens while the electrodes are not in the way.
5. Re-install the electrodes into the splicer.
6. Turn splicer on.
7. Perform an ARC calibration to calibrate the power to the electrodes.

### Motor Drive

Used to manually control the motors.

1. Press the arrow keys to move to the selected drive motor.
2. Press OK to change the speed of the motor.
3. Press the appropriate arrow key to select the desired motor.
4. Press the BACK to exit.

### Motor Calibration (FSP200 only)

Used to auto adjust the motor's position.

1. Prepare and load left and right fibers.
2. Press OK and wait for the splicer to automatically calibrate the motor positions.

### Screen Adjust

Used to adjust the fiber position when the fibers are displayed outside of the displayed screen boundaries.

1. Prepare and load left and right fibers.
2. Press OK and then press the arrow keys to switch between X and Y screen views.
3. Use the arrow keys to adjust the fiber positions.
4. Press OK to confirm modification.
5. Press BACK to exit.

### Replace Electrodes

1. Turn splicer OFF. Remove battery and unplug from AC power.
2. Replace the electrodes.
3. Power splicer ON.
4. Select "Replace Electrodes" from menu.
5. Follow on-screen prompts. (This process may take 10 minutes.)

### Stabilize Electrodes

Perform this function when the splicer is not performing properly and/or when the arc display is not a uniform light pattern.

1. Prepare and load left and right fibers.
2. Press OK and wait for the splicer to automatically stabilize the electrodes.

## Splice Set

Splice setting options include splicing control, display settings, and splice limit settings for all splice profiles.

Navigate to the “Splice Set” icon and press OK.

Each menu item can be enabled or disabled per the user’s preference.

- Auto Start: The splice will automatically be started when the windshield is closed.
- Pause 1: Enabling allows the technician to inspect the fiber end faces before the cleaning ARC by causing the fusion splicer to pause.
- Pause 2: Enabling allows the technician to inspect the fiber alignment before the splicing operation by causing the fusion splicer to pause.
- Display Cleaving Angle: Displays the cleave angle of both fibers.
- Display Axis Offset: Displays the axial offset between the two fibers.
- Display Loss: Displays the estimated loss of the splice.
- Cleave Limit: Will display
- Axis Offset Limit: Enable to force the splicer to attempt a splice even though the axial offset limit between the two fibers is violated.
- Auto Fiber Forward: Enabling allows the fusion splicer to advance the fibers towards each other upon closure of the windshield.
- Realign after pause 2: Enabling allows the technician to realign the fibers prior to the splice being started.
- Max. Number of Rearcs: This number will provide a limit as to how many Re Arcs are permitted for the current splice.
- Adjust ARC position: The technician can enable or disable the splicer from automatically adjusting the ARC position.
- Display Fiber Type: The technician can enable or disable the splicer from displaying each fiber type.
- Diagnostic Test: Enabling will prompt the fusion splicer to automatically check the condition of the motors and windshield. When this function is enabled, all motors are fully tested and the fusion splicer boot time is slower. When this function is disabled, only the left and right motors are checked, and the boot time is faster. If there is a fault, the display will prompt the technician that there is a windshield or motor failure.
- Align: The technician can set the FSP200 for full core alignment mode or clad alignment mode.
- ECF: Enabling the ECF will allow the FSP200 to automatically adjust slightly mis-aligned fibers.

Interaction between cladding alignment, core eccentricity, core alignment, and surface tension. Left side diagram shows fiber following alignment but prior to splicing, corresponding right side depicts outcome of splice. Figures depicts core with a solid heavy line and center of cladding with a dashed line.

- (a) Concentric fiber cores with claddings misaligned. Note the characteristic core deformation of misaligned cores. The resulting deformation generally results in elevated splice loss.
- (b) Eccentric core fibers aligned to each others claddings. Such lateral misalignment of the cores results in high splice loss.
- (c) Eccentric core fibers aligned to each other’s core. Usually, the fact that the cores are laterally misaligned far from the completed splice results in high loss even though the cores are aligned locally at the finished splice.
- d) Eccentric fibers offset an extra amount to ensure that cores are aligned far from the completed splice despite local deformation at the splice. This case often results in lower loss than case (c).

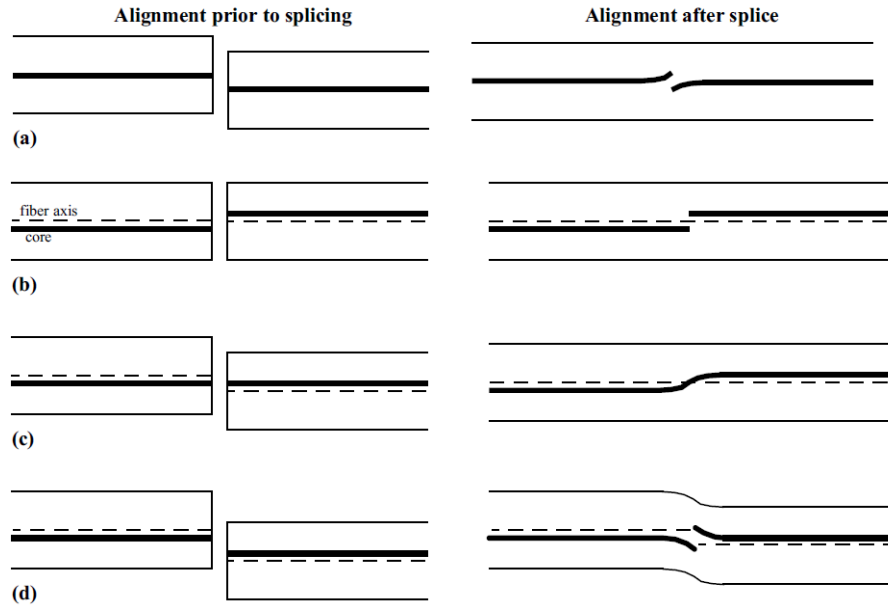

## Data Save

The FSP200 & 915FS stores up to 5000 splicing results.

## Splice Memory

The Splice Memory function allows the user to display, export, and clear splice memory. Use arrow keys to select "Splice Memory" in Data Save menu, and press Enter to confirm.

## Display Splice Memory

Allows the user to display all of the splices made on the splicer.

## Export Splice Memory

Allows the user to export the splice records within the splicer via the USB port.

## Clear Splice Memory

Allows the user to delete all splice records from the splicer.

## Format Memory

Allows the user to format the entire memory.

## Clear Arc Count

Allows the user to reset the ARC count to zero. This is particularly useful to reset to zero when replacing the electrodes so that the number of ARC's can be tracked.

## Maintenance INFO

- Total Fusion Count: Displays the total number of splices made on the fusion splicer.
- Software Version: Displays the software version of the splicer.
- Serial Number: Displays the fusion splicer serial number.

The FSP200 and 915FS can save up to 100 screen shots. Press the camera icon to make a screen shot. The screen shots can be downloaded via USB.

## Set

This menu is used to set system settings.

### Language

Navigate to select the desired language.

### Beep Switch

Set or disable the beeper notification.

### Screen Direction

Set for front or back operation.

### LCD Auto Turn-Over

Enable or disable the splicer for the LCD to display the splice screens when the LCD screen is tilted to a different axis.

### Auto Heat Switch

When enabled the heater will automatically start when the heater door is closed.

### Power Save

The Power Save function conserves energy by turning off the LCD and/or the entire splicer.

### Monitor Shut Down

The user can select or disable when/if the LCD can be turned off after a period of inactivity. The time is adjustable from 0-20 minutes.

### Splicer Shut Down

The user can select or disable when/if the LCD can be turned off after a period of inactivity. The time is adjustable from 0-20 minutes.

### LCD Brightness

The brightness of the LCD can be adjusted to compensate for ambient lighting conditions.

### Set Calendar

The date and local time can be set.

### Sensor Value

The barometric pressure and temperature at the electrode are displayed here.

### Load Default

The user can reset all settings to factory settings

## Update

Provides the utility to update the firmware.

## Password

Provides the technician the opportunity to create a password to prevent the FSP200 & 915FS from being used by unauthorized users. The fusion password will allow the splicer to be accessed but a splice can not be made without the password. The fusion limit password will allow a preset number of splices to be made before access will be denied. This is useful in demonstration or rental situations.

When the password function is enabled, select "Set Password". Select characters, add spaces, delete characters, or confirm. (The password max. length is 8, and it can be uppercase letters, lowercase letters, numbers, or symbols ). Finish setting by selecting "FINISH".

When the splicer is restarted, the password interface is displayed. Customer can use the password to unlock.

To cancel the password function, select "Set password", and then select "FINISH" (input nothing for password).

## For service







In the password interface, there is "Super password," and the "[XX]" following is the coordinate of "super-password.xlsx."

By using the super password, the user or service staff can unlock the splicer to renew the password. The super password is obtained from Tempo Communications customer service. For each restart, the [XX] is changed, so the user cannot use the last super password again and needs to contact customer service.

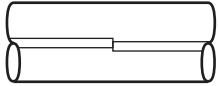

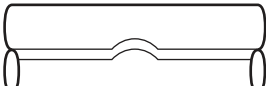
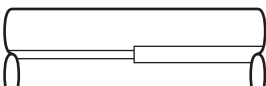
(1) Fast mode. (2) 90s/cycle splice time and power save functions activated. Number of cycles may vary depending on battery status and ambient operating conditions. (3) Dust resistance and rain resistance test do not guarantee that the product will not be damaged under these conditions. (4) Dependent on splice protector used and ambient conditions. Time quoted is assuming that the oven is not cold.  
\*Specifications subject to change without notice.

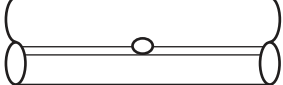
## Section 5. Troubleshooting

### High Splice Loss Cause and Remedy

Symptom	Cause	Remedy
Core axial offset 	Dust on V-groove or fiber clamp chip.	Clean V-groove and fiber clamp chip.
Core angle 	Dust on V-groove or fiber clamp chip damaged.	Clean V-groove and fiber. Check clamp chip.
	Bad fiber end-face quality.	Check if fiber cleaver is clean and in good condition.
Core step 	Dust on V-groove or fiber clamp chip.	Clean V-groove and fiber clamp chip.
Core curve 	Bad fiber end-face quality.	Check if fiber cleaver is clean and in good condition.
	Prefuse power too low, or prefuse time too short.	Increase "Prefuse Power" and/or "Prefuse Time".
MFD mismatch 	Arc power too low.	Increase "Arc Power" and/or "Arc Time".
Combustion 	Bad fiber end-face quality.	Check if fiber cleaver is clean and in good condition.
	Dust still present after cleaning fiber or cleaning arc.	Clean fiber thoroughly and/or increase "Cleaning Arc Time."
Bubbles 	Bad fiber end-face quality.	Check if fiber cleaver is clean and in good condition.
	Prefuse power too low, or prefuse time too short.	Increase "Prefuse Power" and/or "Prefuse Time".
Separation 	Fiber stuffing too small.	Perform "Motor Calibration".
	Prefuse power too high, or prefuse time too long.	Decrease "Prefuse Power" and/or "Prefuse Time".

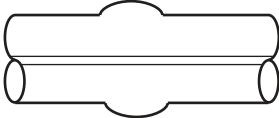
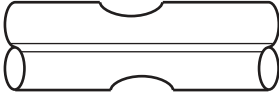
## High Splice Loss Cause and Remedy (cont'd)

Symptom	Cause	Remedy
<p>Fat</p> 	Fiber stuffing too much.	Decrease "Overlap" and perform "Motor Calibration".
<p>Thin</p> 	Arc power not adequate.	Perform "Arc Calibration".
	Some arc parameters not adequate.	Adjust "Prefuse Power", "Prefuse Time", or "Overlap".
<p>Line</p> 	Some arc parameters not adequate.	Adjust "Prefuse Power", "Prefuse Time", or "Overlap".

Note: A vertical line sometimes appears at the splice point when MM fibers or dissimilar fibers (different diameters) are spliced. This does not affect splice quality, such as splice loss or tensile strength.

Note: If the user is getting high splice losses, make sure that the splicer is not in Splice Mode #10, which is used to make attenuator splices.

### Cleaver

If the cleaver does not cleave, make sure that the 250 micron acrylic coating is being removed during the fiber stripping process. Also make sure that there is no debris on the presser pads as debris will prevent the fiber to be cleaved from being held properly.

## Error Messages

Error Message	Reason	Solution
Left/Right/L-R fiber set too close!	<ul style="list-style-type: none"> <li>The fiber end-face is placed on the electrode centerline, or beyond it.</li> <li>The cleave length (bare fiber part) is too long.</li> <li>Dust or dirt is on the objective lens or the wind protector mirror.</li> </ul>	<ul style="list-style-type: none"> <li>Confirm the setting position of the stripped fiber end on the fiber cleaver. Check the cleave length.</li> <li>Clean the lens or the mirror when dust or dirt exists.</li> </ul>
Left/Right/L-R fiber set too far!		
Reset Left/Right fibers!		
Clear Left/Right fibers!	<ul style="list-style-type: none"> <li>Dust or dirt is on the objective lens or the wind protector mirror.</li> <li>“Cleaning Arc” time is too short or OFF.</li> <li>Splicing indistinct core fibers with the SM or DS modes.</li> <li>“Align” is set to “Core” to splice indistinct core fibers when using other splice modes.</li> <li>“Focus” is incorrectly set when using other splice modes.</li> </ul>	<ul style="list-style-type: none"> <li>Completely prepare the fiber again (strip, clean, and cleave).</li> <li>Clean the lens or the mirror if dust or dirt exists.</li> <li>Set the “Cleaning Arc” time to “30ms.” When splicing carbon-coated fibers, set to “100ms.”</li> <li>Use the MM mode to splice indistinct core fibers (i.e., MM fiber).</li> <li>Set “Align” to “Clad” to splice indistinct fibers (i.e., MM fiber).</li> <li>Set “Focus” to “Edge” to splice indistinct core fibers (i.e., MM fiber). To splice distinct core fibers, enter “Auto” or the correct focus value.</li> </ul>
Left/Right fiber X/Y set error!	<ul style="list-style-type: none"> <li>The fiber is not set correctly at the bottom of the V-groove. The fiber position is out of focus range.</li> <li>Dust or dirt is on the fiber surface resulting in focus failure.</li> <li>Dust or dirt is on the objective lens or the wind protector mirror.</li> </ul>	<ul style="list-style-type: none"> <li>Press <b>X</b>, and re-position the fiber to seat it correctly at the bottom of the V-groove.</li> <li>If fibers are not shown, use “screen adjust.” Follow the procedure displayed to enable the entire fiber to be displayed.</li> <li>Completely prepare the fiber again (strip, clean, and cleave).</li> <li>Clean the lens or the mirror if dust or dirt exists.</li> </ul>
X/Y Motor out of range!		
Cover is open!	The wind protector is opened during splicing operation.	Press <b>X</b> after closing the wind protector.
Left/Right/L-R fiber angle errors, shape errors and clear left & right errors	<ul style="list-style-type: none"> <li>“Core Angle Limit” is set too low.</li> <li>Dust or dirt is on the V-groove or the clamp chip.</li> <li>Bad fiber end-face.</li> </ul>	<ul style="list-style-type: none"> <li>The splicer measures the core angle only when using other splice modes. Increase the “Core Angle Limit” to an adequate limit. (1.0 degree is standard.)</li> <li>Clean the V-groove and clamp chip, and set the fibers again. If the error occurs again, strip, clean, and cleave the fibers.</li> <li>Check the condition of fiber cleaver. If the blade is worn, rotate the blade to a new position.</li> </ul>

**Error Messages (cont'd)**

<b>Error Message</b>	<b>Reason</b>	<b>Solution</b>
Display "Wait Download.."	ON/OFF and ENTER buttons are held at the same time.	Power off. Power back on.
	Component damage – keypad.	Keypad replacement required.
LEFT_FIBER_DIRTY RIGHT_FIBER_DIRTY LR_FIBER_DIRTY	Fibers are dirty.	Clean fiber and recleave.
	V-grooves are dirty.	Clean V-grooves.
	V-grooves are damaged.	V-grooves need to be factory replaced.
	Fiber presser foot is dirty.	Clean presser foot of the splicer.
	Fiber adapters are dirty.	Clean fiber adapters.
	Mirrors are dirty.	Clean mirrors .
	Lenses are dirty.	Clean lenses.
LR_ARC_VALUE_ERR	Fibers are dirty, passing the limit of checking process.	Clean fiber and recleave.
	Cleave angle is too big.	Recleave fibers to obtain good cleave angle.
	Failure to do the arc calibration.	Do arc calibration.
	Electrodes are oxidized.	Clean electrodes or replace with a new pair.
	Lenses are dirty.	Clean lenses.
FIBER_PUSH_ERR	Fiber is not in V-groove.	Replace fiber and check if fiber is in the V-groove.
	Fiber holder is not tight.	Reposition the fiber.
	Backward tension is on fiber.	Release any tension on fiber.
	The adapter holder is dirty.	Clean the fiber adapter holder.
ARC_OFFSET_TOO_LARGE	Failure to do the arc calibration.	Do arc calibration.
	Electrodes position error.	Check and or replace electrodes.
	Electrodes are broken.	Replace electrodes.
	Electrodes are oxidized.	Replace electrodes.
LENS_OFFSET_TOO_LARGE	Fiber is beyond observation range.	Perform "Screen Adjust" to allow fibers to be displayed on the screen.
COVER_OPEN when the windshell is closed	The magnet on windshell is missing.	Magnet needs to be factory replaced.
Notified to replace electrodes	Electrodes require calibration or replacement.	Stabilize electrodes as per Menu 3; replace electrodes.

## If High Estimated Loss

Reason	Solution
Insufficient fiber cleaning.	Dust or dirt on the fiber surface results in bad splice loss and low tensile strength. <ul style="list-style-type: none"> <li>• Clean the fiber surface sufficiently.</li> <li>• Do not clean the fiber after cleaving to prevent dust on the fiber end-face.</li> <li>• Avoid any contact with the fiber end-face.</li> <li>• Press  to perform an arc calibration as defined in this instruction manual.</li> </ul>
Bad fiber end-face.	<ul style="list-style-type: none"> <li>• Check the condition of fiber cleaver. If the blade is worn, rotate the blade to a new position.</li> <li>• Confirm the “Cleave Limit” setting; 2.0° or less is recommended.</li> </ul>
Dust or dirt is on the V-groove or the clamp chip.	Dust or dirt on the V-groove or clamp chip causes poor fiber movement during fiber adjusting. Clean them periodically.
Dust or dirt is on the lens or mirror.	If dust or dirt exists, clean the lenses or mirrors.
Bad electrode condition.	Replace the electrodes if they appear worn (rounded tip shape), dirty, or bent.
Inadequate arc power.	Calibrate the arc power with the “Arc Calibration” function.
Using unsuitable splice mode.	Select a suitable splice mode for the fibers to be spliced.
“Loss Limit” is set too low.	Increase “Loss Limit” to an adequate limit.
Fibers were spliced after Error was canceled.	Select the appropriate splice mode from the Other modes.
Inadequate arc parameters in other splice modes.	Confirm the arc parameters are adequate to splice the fibers.
Inadequate estimating parameters in Other mode.	Confirm the estimating parameters are adequate to estimate the loss. The MFD mismatch function does not work for certain types of specialty fibers. In these cases, set the “MFD Mismatch” to OFF.

Note: The fiber identification may mis-report the fiber type up to 15% of the time due to fiber optic cable manufacturers fiber variations from what is classified as a particular fiber type.

## Appendix A. Fusion Splicer Cleaning

### Precautions When Cleaning

- Turn off splicer.
- Use only lint-free cotton swabs.
- Use only 99% pure isopropyl alcohol or an approved substitute.
- Do not touch the electrodes.
- Never use compressed air.
- Use the cleaning brush only to clean debris from general working area, never on the lenses, or V-grooves.

### Cleaning V-grooves (recommended daily)

Refer to Figure 1.

Clean the bottom of the V-groove with an isopropyl alcohol-impregnated lint-free cotton swab. Remove excess alcohol from the V-groove with a clean, dry lint-free cotton swab.



Figure 1

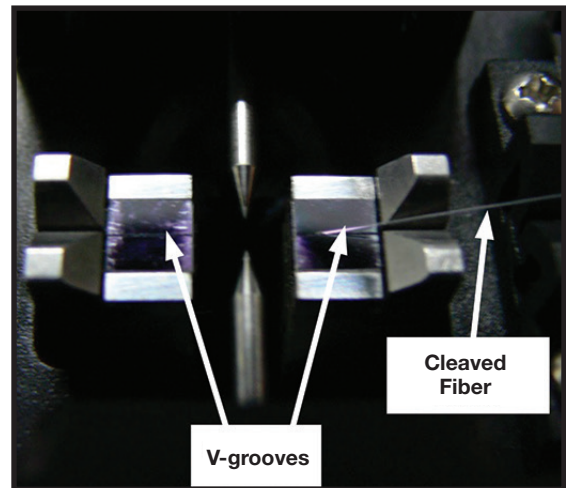

Figure 2

If the contaminants in the V-groove cannot be removed with an alcohol-impregnated lint-free cotton swab, use a cleaved fiber end-face to dislodge contaminants from the bottom of the V-groove. Refer to Figure 2. Repeat cleaning the V-grooves as in Figure 1.

### Cleaning Fiber Clamps (recommended daily)

If contaminants are present on the clamps, proper clamping may not occur, resulting in poor quality splices. The fiber clamps should be inspected frequently and cleaned periodically during normal operation. To clean the fiber clamps, do the following: Clean the surface of the clamps with an alcohol-impregnated lint-free cotton swab. Remove excess alcohol from the clamps with a clean, dry lint-free cotton swab.

### Cleaning Objective Lenses (recommended weekly)

Refer to Figure 3.

If the surfaces of the objective lenses become dirty, normal observation of the core position may be incorrect, resulting in higher splice loss or poor splicer operation. Therefore, clean both of them at regular intervals. Otherwise, dirt may accumulate and become impossible to remove. To clean the objective lenses, do the following:

- Before cleaning the objective lenses, always turn off the splicer.
- Gently clean the lenses' (X-axis and Y-axis) surfaces with a dry lint-free cotton swab. Using the swab, start at the center of the lens and move the swab in a circular motion until you spiral out to the edge of the lens surface.
- The lens surface should be clean and free of streaks or smudges.
- Turn on the power and make sure no smudges or streaks are visible on the monitor screen. Press X/Y to change the screen and check the state of the lens surface on both the X- and Y-screens.

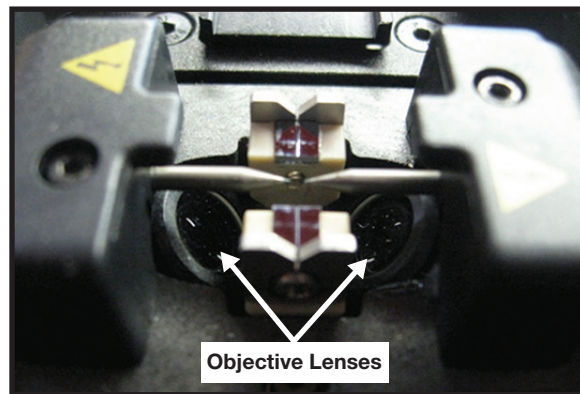

Figure 3

**NOTE:**

- Do not touch the electrodes when cleaning.
- It is recommended to clean the objective lenses when replacing the electrodes.

### Cleaning the Electrodes

1. Insert the electrode tip into the hole of the electrode polisher and gently rotate the electrode.
2. Wipe the electrodes with 99% pure IPA. Do not touch the electrode surface with your fingers.
3. Re-install the electrodes into the splicer.
4. Perform a stabilize electrodes to calibrate the power to the electrodes.

### General Fusion Splicer Cleaning (recommended daily)

- Use the cleaning brush only to clean debris from general working area, never on the lenses, V-grooves, or mirrors.
- Periodically clean the fiber adapters with isopropyl alcohol and a lint-free cotton swab. Never touch the fiber clamping area of the fiber adapters.

### Cleaning Fiber Cleaver (recommended daily)

Refer to Figure 4.

If the circular blade or clamp pads of the fiber cleaver become contaminated, the cleaving quality could degrade. This may lead to fiber surface or end-face contamination, resulting in higher splice loss. Clean the circular cleaving blade and clamp pads with a lint-free cotton swab soaked with isopropyl alcohol.

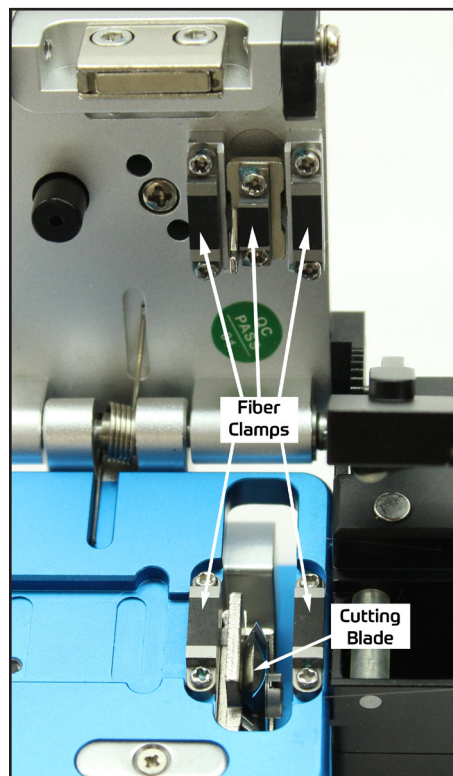

Figure 4

## Appendix B. Practice Splicing

### General Precautions

- Refer to the contents of this instruction manual.
- Clean all connectors before making a connection.

**It is highly recommended that new users use the AUTO mode splicing profile until they have become proficient at splicing.**

### Checking the Splice Quality

The user should practice splicing with the type of fiber that they will use in their installation before attempting to splice fibers in those installations.

The following procedure should be used to practice fusion splicing fiber cables:

1. Identify the field fiber type by consulting the fiber manufacturer's data sheet.
2. Obtain an approximately 10 m length of fiber (same as field fiber).
3. Determine if this fiber type has a pre-programmed splicing profile. Use this profile for splicing.
4. If there is not an exact matching splice profile, use the AUTO mode splicing profile.
5. Splice a fiber pigtail with a suitable connector for their source/power meter of like fiber to one end of the 10 m fiber.
6. Splice a fiber pigtail with a suitable connector for the source/power meter of like fiber to the other end of the 10 m fiber.
7. Connect a laser (SM) or LED (MM) source to one end of the fiber and a power meter to the other end of the fiber. Refer to Figure 1.
8. Zero the power meter. Refer to Figure 2.
9. Cut the 10 m piece of fiber in the middle and splice it back together. The power meter should read 0dB PLUS allowable splice loss X2.
10. The splicing technician should repeat step 9 until they are able to reliably splice using the desired fiber.

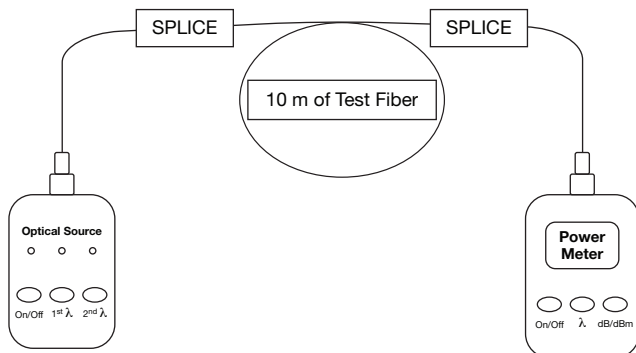

Figure 1

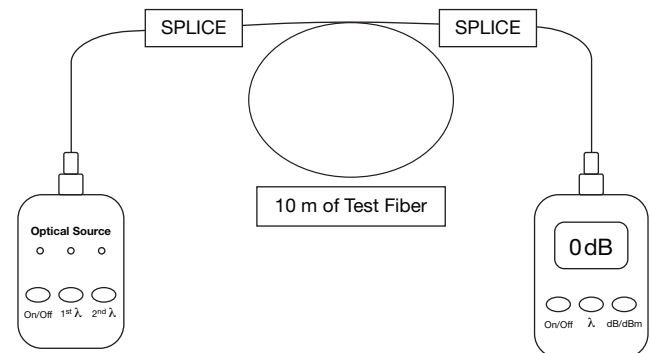

Figure 2

### **Limited Warranty**

Tempo Communications Inc. warrants to the original purchaser of these goods for use that these products will be free from defects in workmanship and material for three years, excepting normal wear and abuse.

For all Test instrument repairs, you must first request a Return Authorization Number by contacting our Customer Service department at:

toll free in the US and Canada 800-642-2155

Telephone +1 760 510-0558.

Facsimile +1 760 598-9263.

Repair@tempocom.com

For items not covered under warranty (such as dropped, abused, etc.) repair cost quote available upon request.

### **Tempo Communications**

1390 Aspen Way • Vista, CA 92081 • USA

800-642-2155

Tempo Europe Ltd. • Brecon House, William Brown Close

Cwmbran, NP44 3AB, UK • Tel: +44 1633 927 050

**[www.TempoCom.com](http://www.TempoCom.com)**