

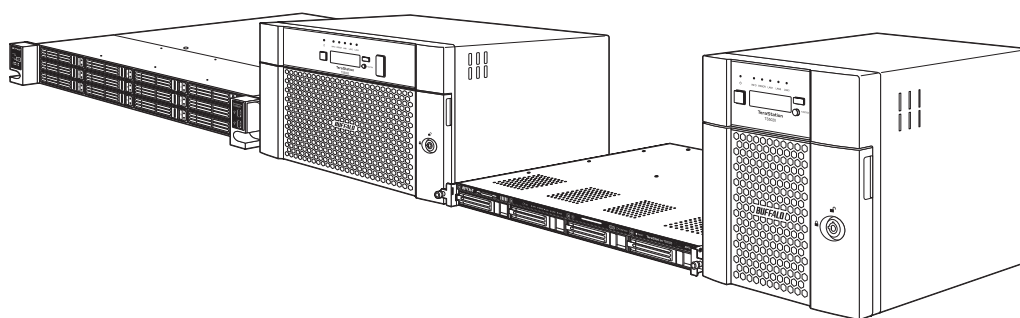

**Network Attached Storage  
TeraStation 5020**

# **User Manual**



Please make sure to read this manual before using and follow the procedures. If you have any inquiries about the product, contact the number on the warranty statement or the packing box. Do not discard the included documents, the warranty statement, or the packing box.

***[www.buffaloamericas.com](http://www.buffaloamericas.com)***

35022387-03  
February 2023

# Table of Contents

<b>Chapter 1 Notice .....</b>	<b>10</b>
Regulatory Compliance Information.....	10
Warning Symbols and Graphical Icons on the Product.....	10
Safety Precautions .....	10
<b>Chapter 2 Getting Started .....</b>	<b>12</b>
Diagrams.....	12
4-Bay and 8-Bay Desktop Models, 4-Bay Rackmount Model .....	12
12-Bay Rackmount Model .....	15
Turning the TeraStation On and Off.....	17
Creating a USB Initialization Drive .....	17
Accessing Settings .....	17
Opening Settings .....	18
Configuring Settings via Setup Wizard .....	20
Checking the Device Information from Dashboard .....	21
Shutting Down or Restarting the TeraStation from Settings .....	22
<b>Chapter 3 File Sharing .....</b>	<b>23</b>
Configuring Shared Folders .....	23
Adding a Shared Folder .....	23
Recycle Bin.....	25
Read-Only Shares.....	25
Hidden Shares .....	26
Configuring Users .....	26
Adding a User .....	26

<b>Importing User Information.....</b>	<b>29</b>
<b>Adding a Group .....</b>	<b>29</b>
<b>Configuring Access Restrictions .....</b>	<b>32</b>
<b>Restricting Local User Access to Shared Folders .....</b>	<b>32</b>
<b>Restricting AD Domain User Access to Shared Folders.....</b>	<b>34</b>
<b>Restricting Access to Subfolders .....</b>	<b>37</b>
<b>Enhancing Compatibility for macOS Client Access .....</b>	<b>39</b>
<b>NFS .....</b>	<b>40</b>
<b>Enabling NFS .....</b>	<b>40</b>
<b>NFS Mount Commands .....</b>	<b>45</b>
<b>Offline Files for Windows.....</b>	<b>45</b>

## **Chapter 4 RAID Modes and Drive Management .....** **48**

<b>Available RAID Modes .....</b>	<b>48</b>
<b>Working with RAID Arrays .....</b>	<b>49</b>
<b>Using JBOD .....</b>	<b>49</b>
<b>Creating a RAID Array .....</b>	<b>50</b>
<b>Shutting Down the TeraStation Automatically If an Error Occurs.....</b>	<b>51</b>
<b>Rebuilding the RAID Array Automatically for the TS51220RH.....</b>	<b>53</b>
<b>Configuring Actions for If a Drive Used for the RAID Array Has Not Been Detected .....</b>	<b>55</b>
<b>Configuring a Hot Spare.....</b>	<b>57</b>
<b>Managing a RAID Array Without Deleting Data .....</b>	<b>59</b>
<b>RAID Scanning.....</b>	<b>63</b>
<b>Configuring Low Drive Space Alerts .....</b>	<b>64</b>
<b>Adding an External Drive .....</b>	<b>65</b>
<b>Dismounting Drives .....</b>	<b>66</b>
<b>Using the Function Button .....</b>	<b>67</b>

Using Settings .....	67
<b>Checking Drives .....</b>	<b>68</b>
<b>S.M.A.R.T. ....</b>	<b>69</b>
Displaying S.M.A.R.T. Information .....	70
Checking the Drive Condition.....	71
<b>Formatting Drives .....</b>	<b>71</b>
<b>Encrypting Drives.....</b>	<b>73</b>
<b>Erasing Data on the TeraStation Completely .....</b>	<b>73</b>
<b>Quotas.....</b>	<b>74</b>
Limits for Shared Folders .....	74
Limits for LVM Volumes .....	75
<b>Using the TeraStation as an iSCSI Device .....</b>	<b>78</b>
Introduction .....	78
Creating an iSCSI Volume .....	79
Connecting Volumes.....	81
Formatting Volumes .....	82
Disconnecting Volumes.....	82
Configuring Access Restrictions .....	82
Connecting Access-Restricted Volumes .....	85
Expanding Volume Sizes .....	86
Deleting Volumes.....	88
Enabling the iSNS Protocol .....	89
Advanced iSCSI Volume Settings.....	90
<b><u>Chapter 5 Backup .....</u></b>	<b><u>91</u></b>
<b>Snapshots .....</b>	<b>91</b>
Overview .....	91
Application for iSCSI Volume Snapshots .....	91

Manually Creating a Snapshot.....	91
Accessing the Snapshots via SMB.....	95
Restoring Snapshots.....	97
Configuring Schedule Snapshot.....	101
Configuring Snapshot Archive Settings.....	105
<b>Backing Up Data on the TeraStation.....</b>	<b>111</b>
Backup Modes.....	112
Preparing a Backup Destination.....	115
Configuring a Backup Job .....	117
If Backing Up from rsync-Compatible Devices to the TeraStation .....	122
Restoring Backup Data .....	123
Backup Logs for If Backup Fails .....	127
<b>Replication.....</b>	<b>130</b>
Preparing a Replication Destination .....	131
Configuring a Replication Job .....	133
Synchronizing Between Source and Destination TeraStations Periodically.....	135
<b>Failover .....</b>	<b>136</b>
Before Configuring Failover.....	137
Usage Restrictions .....	138
Configuring Failover.....	139
Changing Settings While Failover Is Configured.....	141
Maintenance Mode .....	141
Synchronizing Between Main and Backup TeraStations Periodically.....	144
Switching to the Backup TeraStation Manually.....	146
Reconfiguring After Failover Occurs .....	146
Stopping Failover.....	148
<b>Backing Up Your Mac with Time Machine .....</b>	<b>150</b>

## **Chapter 6 Cloud Services and Remote Access..... 156**

<b>Synchronizing with Amazon S3 .....</b>	<b>156</b>
<b>Creating an Amazon S3 Job .....</b>	<b>156</b>
<b>Uploading Files to Amazon S3.....</b>	<b>159</b>
<b>Synchronizing with Dropbox .....</b>	<b>163</b>
<b>Creating a Dropbox Sync Job.....</b>	<b>163</b>
<b>Changing Job Settings .....</b>	<b>166</b>
<b>Creating a Shared Link (Windows Only).....</b>	<b>169</b>
<b>Using Microsoft Azure for Data Preservation .....</b>	<b>169</b>
<b>Creating an Azure Storage Sync Backup Job.....</b>	<b>169</b>
<b>Creating an Azure Storage Sync Restore Job.....</b>	<b>177</b>
<b>Changing Job Settings .....</b>	<b>182</b>
<b>Synchronizing with Microsoft OneDrive .....</b>	<b>185</b>
<b>Creating a OneDrive Sync Job.....</b>	<b>185</b>
<b>Changing Job Settings .....</b>	<b>196</b>
<b>Corrective Actions for in Case of Error .....</b>	<b>198</b>
<b>WebAccess .....</b>	<b>201</b>
<b>Configuring WebAccess.....</b>	<b>201</b>
<b>Accessing via WebAccess.....</b>	<b>204</b>
<b>Unable to Create a BuffaloNAS.com Name .....</b>	<b>205</b>
<b>FTP.....</b>	<b>206</b>
<b>Enabling FTP .....</b>	<b>206</b>
<b>Accessing the TeraStation with an FTP Client.....</b>	<b>207</b>

## **Chapter 7 Security Enhancement..... 209**

<b>Two-Factor Authentication .....</b>	<b>209</b>
<b>Enabling Two-Factor Authentication .....</b>	<b>209</b>
<b>Restricting Logins for Non-Admin Users.....</b>	<b>214</b>

Disabling Two-Factor Authentication .....	216
<b>Encrypting Data Transmission .....</b>	<b>218</b>
Encrypting Settings Data .....	218
Encrypting FTP Transfer Data .....	219
SSL.....	219

## **Chapter 8 Settings Backup/Restoration ..... 221**

<b>Saving and Applying Settings.....</b>	<b>221</b>
Saving Settings .....	222
Applying Settings .....	222
<b>Transferring Another Buffalo NAS Device's Settings .....</b>	<b>223</b>
Creating a Config File (.nas_config).....	224
Transferring Settings.....	224
<b>Restoring Factory Defaults.....</b>	<b>225</b>
Initializing from Settings .....	225
Initializing Using the USB Initialization Drive .....	226
<b>Resetting the Administrator Password .....</b>	<b>227</b>

## **Chapter 9 Network Settings ..... 229**

<b>Wake-on-LAN .....</b>	<b>229</b>
<b>Port Trunking.....</b>	<b>229</b>
<b>SNMP .....</b>	<b>232</b>
<b>Proxy Server .....</b>	<b>234</b>
<b>Jumbo Frames .....</b>	<b>235</b>
<b>Changing the IP Address .....</b>	<b>236</b>
<b>Mapping IP Address and Hostname .....</b>	<b>238</b>

## **Chapter 10 Advanced Features ..... 240**

<b>Email Notification .....</b>	<b>240</b>
<b>Enabling Email Notification .....</b>	<b>240</b>
<b>Changing Events for Email Reports .....</b>	<b>241</b>
<b>Sleep Mode .....</b>	<b>242</b>
<b>UPS (Uninterruptible Power Supply) .....</b>	<b>244</b>
<b>One PSU Device Is Installed.....</b>	<b>245</b>
<b>Two PSU Devices Are Installed.....</b>	<b>246</b>
<b>Automatic Shutdown If Power Supply Fails .....</b>	<b>247</b>
<b>Logs .....</b>	<b>248</b>
<b>Displaying TeraStation’s Logs .....</b>	<b>248</b>
<b>Transferring Logs to the Syslog Server .....</b>	<b>249</b>
<b>Creating a Shortcut to the Logs in the Shared Folder .....</b>	<b>250</b>
<b>Changing Archive Rules for File Access Logs .....</b>	<b>251</b>
<b>Updating the Firmware.....</b>	<b>252</b>
<b>Updating Manually Using Settings .....</b>	<b>252</b>
<b>Enabling Automatic Update.....</b>	<b>253</b>
<b>Configuring Update Notification.....</b>	<b>254</b>
<b>Name, Date, Time, and Language .....</b>	<b>255</b>
<b>Beep Alerts .....</b>	<b>257</b>
<b>LCD and LEDs.....</b>	<b>258</b>

## **Chapter 11 Drive Replacement and Troubleshooting ... ..... 260**

<b>Replacing a Defective Drive on the TS51220RH .....</b>	<b>260</b>
<b>Drive Replacement for a Redundant RAID Array.....</b>	<b>260</b>
<b>Drive Replacement for a RAID 0 Array .....</b>	<b>262</b>

Drive Replacement for a JBOD.....	263
Drive Replacement for a Hot Spare .....	263
<b>Replacing a Defective Drive on Models Other Than the TS51220RH .....</b>	<b>263</b>
Drive Replacement for a Redundant RAID Array (TeraStation Is On)	264
Drive Replacement for a Redundant RAID Array (TeraStation Is Off)	267
Drive Replacement for a RAID 0 Array .....	268
Drive Replacement for a JBOD.....	269
Drive Replacement for a Hot Spare .....	269
<b>Replacing a Non-Malfunctioning Drive.....</b>	<b>270</b>
<b>Re-Inserting Drives .....</b>	<b>270</b>
<b>TeraStation Does Not Work Properly .....</b>	<b>272</b>
Power LED Keeps Blinking .....	272
Booting the TeraStation in Emergency Mode.....	273
<b>Unable to Access Shared Folders .....</b>	<b>273</b>
Opening the Network Credentials Window .....	274
Restoring Owner and Permission Settings .....	274
Configuring Compatible SMB Protocols .....	276
<b>Cleaning the Dustproof Filter .....</b>	<b>277</b>

## **Chapter 12 Utilities..... 280**

---

<b>NAS Navigator2 .....</b>	<b>280</b>
Windows .....	280
macOS.....	280
<b>NovaBACKUP .....</b>	<b>280</b>

**Chapter 13 Appendix ..... 281**

**LCD Panel ..... 281**

**Modes .....281**

**Errors.....282**

**Notices .....283**

**Information Events .....284**

**Default Settings ..... 286**

**Specifications ..... 287**

# Chapter 1 Notice

---

## Regulatory Compliance Information

---

### For Customers in the United States

This device complies with Part 15 of the FCC Rules. Operation is subject to the following two conditions: (1) this device may not cause harmful interference, and (2) this device must accept any interference received, including interference that may cause undesired operation.







This equipment has been tested and found to comply with the limits for a Class A digital device, pursuant to part 15 of the FCC Rules. These limits are designed to provide reasonable protection against harmful interference when the equipment is operated in a commercial environment. This equipment generates, uses, and can radiate radio frequency energy and, if not installed and used in accordance with the instruction manual, may cause harmful interference to radio communications. Operation of this equipment in a residential area is likely to cause harmful interference in which case the user will be required to correct the interference at his own expense.

---

## Warning Symbols and Graphical Icons on the Product

---

Warning symbols are used on the product for safety operation and prevention of injury to you and damage to the unit. The following explains the meanings of symbols used on the product.

	This symbol indicates important warnings or cautions for operation and maintenance. Additional information will follow this symbol.
	This symbol indicates the presence of an alternating current.
	This symbol indicates that the equipment may carry risk of electric shock.
	This symbol indicates danger of hazardous high voltage.
	This symbol indicates a protective earthing terminal.
	This symbol indicates that the protective conductor should be connected first to the protective earthing terminal.
	This symbol indicates that the rack-mounted equipment should not be used for a shelf or a work space.

---

## Safety Precautions

---

Before using your device, basic safety instructions should always be followed.

- (1) Read these instructions.
- (2) Keep these instructions.
- (3) Heed all warnings and follow all instructions.

- (4) The device can only be used in a fixed location, such as a telecommunication center or a dedicated computer room. When you install the device, ensure that the protective earthing connection of the socket-outlet is verified by a technician.
- (5) The socket-outlet shall be installed near the equipment and shall be easily accessible.
- (6) Only use the cables and accessories that are included in the package. Don't use other accessories or cables unless specifically instructed to in the documentation.



- (7) **Caution:** Slide/rail mounted equipment is not to be used as a shelf or a work space.



- (8) **Caution:** Do not remove the cover.



- (9) Do not ingest battery in case of a chemical burn hazard. This product contains a coin/button cell battery. If the battery is swallowed, it can cause severe internal burns within 2 hours and may lead to death. If you think batteries might have been swallowed or placed inside any part of the body, seek immediate medical attention.



- (10) **Caution:** Do not replace the battery. There is risk of explosion if the battery is replaced with one that is an incorrect type.



- (11) High touch current. Connect to earth before connecting to supply.



- (12) **Warning:** Hazardous moving parts. Keep away from moving fan blades.

- (13) This equipment is not suitable for use in locations where children are likely to be present.

# Chapter 2 Getting Started

## Diagrams

Depending on the number or type of drives in the unit, the model name will be different. Check the sticker on the packing box for your unit's model name.

### 4-Bay and 8-Bay Desktop Models, 4-Bay Rackmount Model

#### TS5420DN

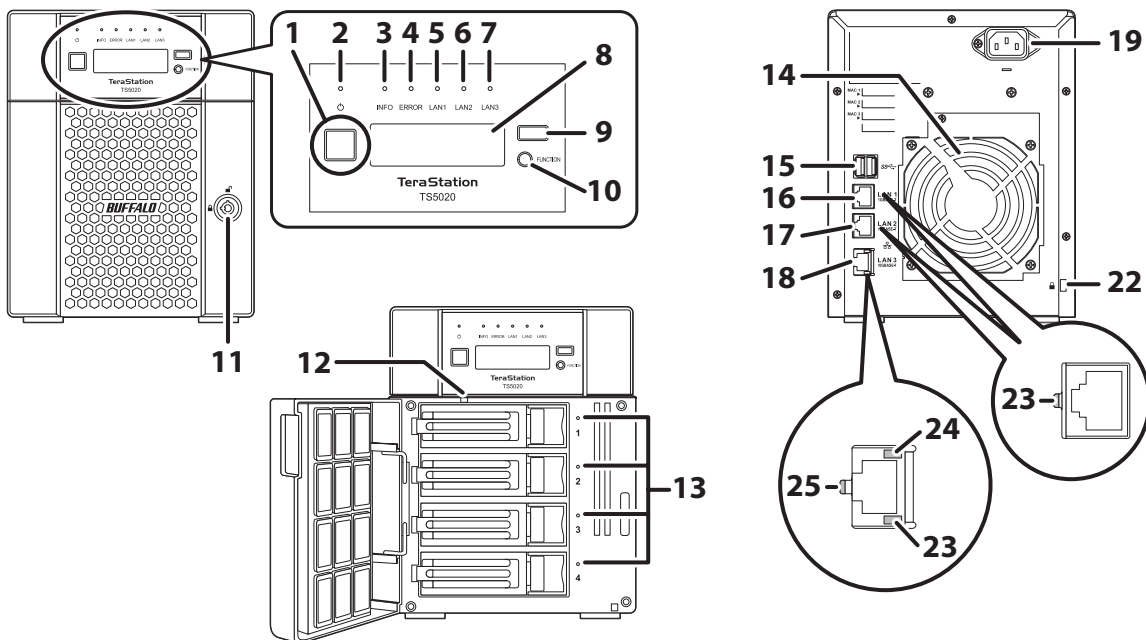

#### TS5420RN

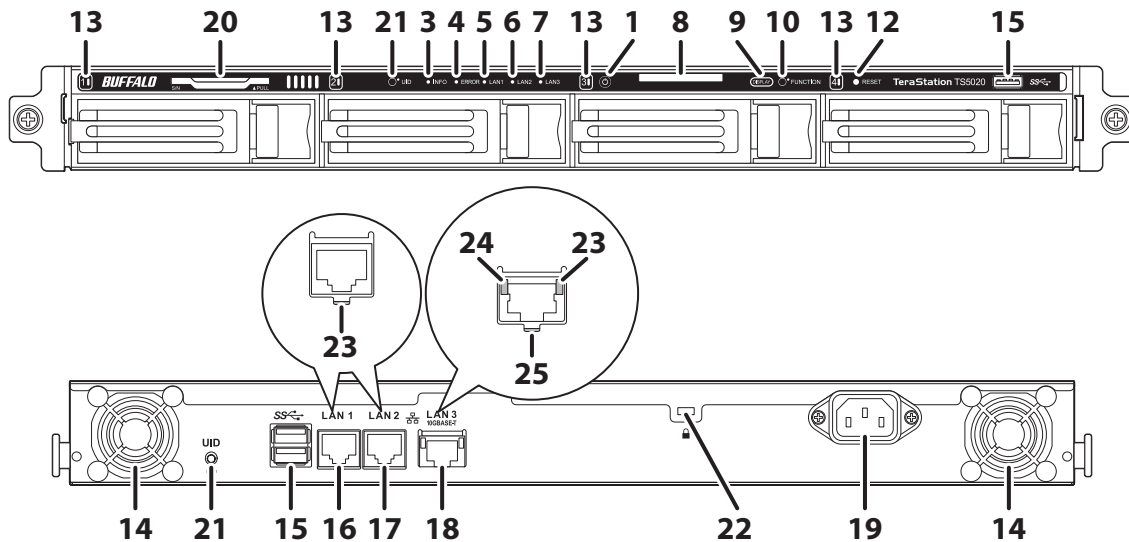

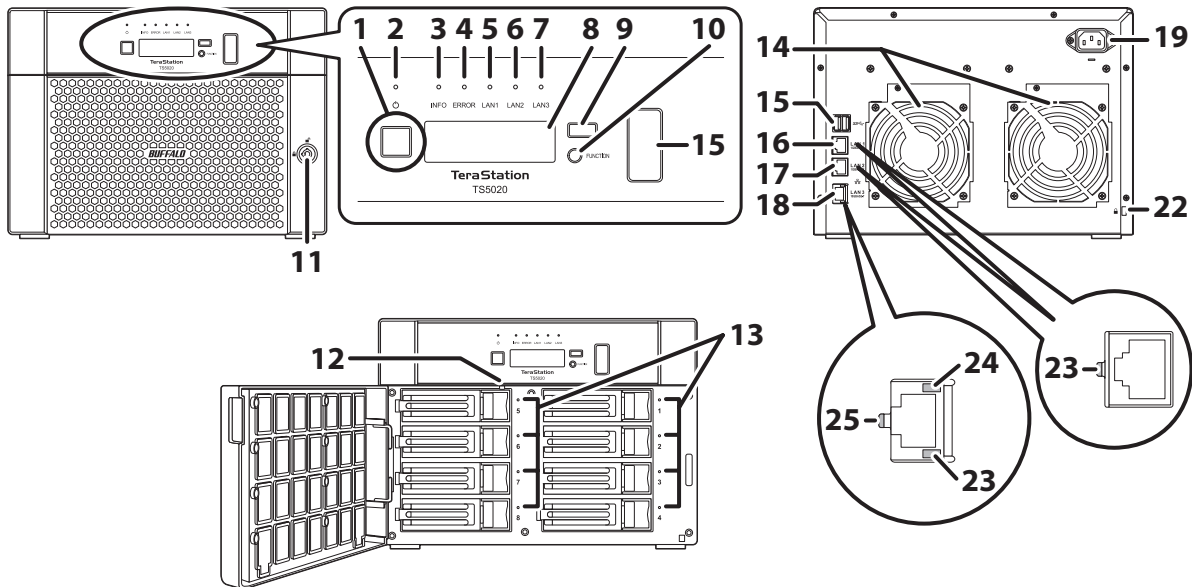
**TS5820DN****1** Power Button

Press this button to power on the TeraStation. To power off the TeraStation, press and hold down the power button for five seconds.

If the TeraStation beeps, pressing and holding this button for a short period will stop the beeping.

**2** Power LED

When the TeraStation is on, the LED glows green.

**3** Info LED

If there is a status message, the info LED will light up amber. Check the LCD panel to see the status message.

**4** Error LED

If there is an error, the error LED will light up red. Check the LCD panel to see the error message.

**5** LAN1 LED

When LAN port 1 is connected, this LED glows green and blinks when the connection is experiencing activity.

**6** LAN2 LED

When LAN port 2 is connected, this LED glows green and blinks when the connection is experiencing activity.

**7** LAN3 LED

When LAN port 3 is connected and the connection is experiencing activity, this LED glows blue.

**8** LCD Panel

This display shows the status of many TeraStation settings. It also displays errors and messages when available.

**9** Display Button

Press to switch between the different display modes. Also, if the TeraStation is beeping, press this button to stop it.

**10** Function Button

Use this button for dismounting USB devices, rebuilding RAID arrays, configuring failover, stopping the TeraStation's beeping, and initializing settings using a USB drive.

## 11 Drive Lock

Open the front panel with the key to replace drives or access the init button.

## 12 Reset Button

Press and hold down this button with something pointed to initialize the TeraStation's admin username and password, two-factor authentication settings, IP settings, SSL, and service port restriction settings to their factory default values. The effects of this button can be changed in Settings.

During initialization, the TeraStation will beep and the **I23** message will appear as a notification. When initialization finishes, the **I23** message will disappear.

## 13 Drive Status LEDs

Normally, these LEDs blink green when drives are accessed. If a drive fails, its LED will turn red.

## 14 Fan

Spins to prevent overheating inside. Do not block the fan.

## 15 USB Port

Compatible USB drives, USB memory devices, and USB UPS devices can be connected. USB hubs are not supported.

For the TS5820DN TeraStation model, the USB port in front is covered by a protector. Remove it before use.

## 16 LAN Port 1 (1GbE)

Connect an Ethernet cable to use this port for your network. It is available for communicating at max. 1000 Mbps.

## 17 LAN Port 2 (1GbE)

Connect an Ethernet cable to use this port for your network. It is available for communicating at max. 1000 Mbps.

## 18 LAN Port 3 (10GbE)

Connect an Ethernet cable to use this port for your network. It is available for communicating at max. 10 Gbps if using the included Ethernet or category 6A cable.

**Note:** To communicate at up to 10 Gbps, all connected network devices must be compatible with 10GbE.

## 19 Power Connector

Use the included power cable to connect to a UPS, surge protector, or outlet.

## 20 Serial Number

This sticker shows the TeraStation's serial number.

## 21 UID Button

Press this button to cycle the blue LED on and off.

## 22 Anti-Theft Security Slot

Use this slot to secure your TeraStation with a cable lock (not included).

## 23 Link/Act LED

Glows green when the TeraStation is connected to a network at 1000 Mbps. It blinks when the connection is experiencing activity.

## 24 Link/Act LED

Glows amber when the TeraStation is connected to a network at 100 Mbps, 2.5 Gbps, or 5 Gbps. It blinks when the connection is experiencing activity.

## 25 Link/Act LED

Glowes blue when the TeraStation is connected to a network at 10 Gbps. It blinks when the connection is experiencing activity.

# 12-Bay Rackmount Model

## TS51220RH

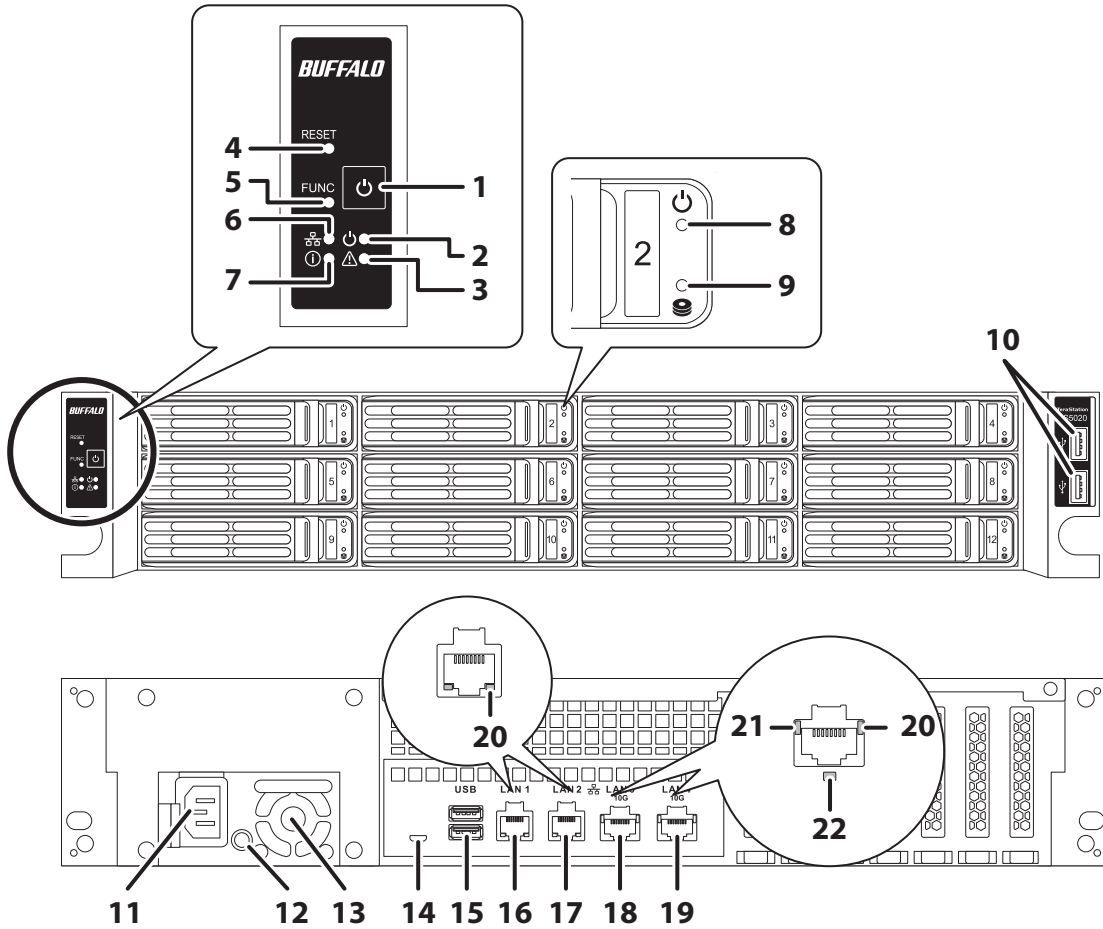

### 1 Power Button

Press this button to power on and off the TeraStation. If the TeraStation beeps, pressing and holding this button for a short period will stop the beeping.

### 2 Power LED

When the TeraStation is on, the LED glows green.

### 3 Error LED

If there is an error, the error LED will light up red.

**Note:** The error LED will be extinguished if the TeraStation is powered off. Check the Settings interface or NAS Navigator2 to see the error message before powering off the TeraStation.

#### **4** Reset Button

Press and hold down this button with something pointed to initialize the TeraStation's admin username and password, two-factor authentication settings, IP settings, SSL, and service port restriction settings to their factory default values. The effects of this button can be changed in Settings.

During initialization, the TeraStation will beep and the I23 message will appear as a notification. When initialization finishes, the I23 message will disappear.

#### **5** Function Button

Use this button for rebuilding RAID arrays, configuring failover, stopping the TeraStation's beeping, and initializing settings using a USB drive.

#### **6** LAN LED

When any LAN ports are connected, this LED glows blue.

#### **7** Info LED

If there is a status message, the info LED will light up amber. Check the Settings interface or NAS Navigator2 to see the status message.

#### **8** Drive Status LED

Glow blue when drives are detected. It blinks when drives are accessed.

#### **9** Drive Error LED

Normally, this LED is extinguished. If a drive fails, its LED will turn red.

#### **10** USB 2.0 Port

Compatible USB UPS devices can be connected. USB drives and USB hubs are not supported.

#### **11** Power Connector

Use the included power cable to connect to a UPS, surge protector, or outlet.

#### **12** Beep Off Button (for Power Supply Unit)

If a PSU error occurred, you will hear the beep from the TeraStation. To stop beeping, press this button.

#### **13** Fan (for Power Supply Unit)

Spins to prevent overheating inside. Do not block the fan.

#### **14** Factory use only.

#### **15** USB 3.2 Gen 1 Port

Compatible USB drives, USB memory devices, and USB UPS devices can be connected. USB hubs are not supported.

#### **16** LAN Port 1 (1GbE)

Connect an Ethernet cable to use this port for your network. It is available for communicating at max. 1000 Mbps.

#### **17** LAN Port 2 (1GbE)

Connect an Ethernet cable to use this port for your network. It is available for communicating at max. 1000 Mbps.

#### **18** LAN Port 3 (10GbE)

Connect an Ethernet cable to use this port for your network. It is available for communicating at max. 10 Gbps if using the included Ethernet or category 6A cable.

**Note:** To communicate at up to 10 Gbps, all network devices must be compatible with 10GbE.

## 19 LAN Port 4 (10GbE)

Connect an Ethernet cable to use the port for your network. The port supports communicating at max. 10 Gbps if using the included Ethernet or category 6A cable.

**Note:** To communicate at up to 10 Gbps, all network devices must be compatible with 10GbE.

## 20 Link/Act LED

Glows green when the TeraStation is connected to a network. It blinks when the connection is experiencing activity.

## 21 Link/Act LED

Glows amber when the TeraStation is connected to a network at 100 Mbps, 2.5 Gbps, or 5 Gbps. It blinks when the connection is experiencing activity.

## 22 Link/Act LED

Glows blue when the TeraStation is connected to a network at 10 Gbps. It blinks when the connection is experiencing activity.

---

## Turning the TeraStation On and Off

---

Press the power button on the TeraStation to turn it on.

To turn off the TeraStation, press and hold down the power button for three seconds. When the power LED turns off, the shutdown process is finished.

Don't unplug the power cable without powering the TeraStation off first.

**Note:** Do not disconnect or reconnect the internal drives while turning the TeraStation on or off.

You can also shut down or restart the TeraStation remotely from Settings. For the detailed procedure, refer to the ["Shutting Down or Restarting the TeraStation from Settings"](#) section below.

---

## Creating a USB Initialization Drive

---

We recommend creating a USB initialization drive as soon as possible. This USB drive can be used to initialize the TeraStation's settings to its factory default values or recover the system if your TeraStation encounters an error that prevents the unit from booting. For the detailed procedure, refer to the ["Creating a USB Initialization Drive"](#) subsection in chapter 8.

---

## Accessing Settings

---

Configure and manage your TeraStation using the Settings interface, accessible from a browser window. Open the interface using the appropriate procedure below or type the TeraStation's IP address into the URL field of your browser.

**Note:** Microsoft Edge, Firefox, Google Chrome, Internet Explorer 9 or later, and Safari 9 or later are supported. If you have difficulty viewing Settings, check the following:

- If there are a large number of registered users, groups, or shared folders, use another browser instead of Internet Explorer.
- If you have a proxy server enabled in the browser settings, configure the exception settings for Settings or disable the proxy server.
- With Internet Explorer, set security to *Local intranet*. On Windows Server operating systems, higher-level security is configured by default. Set the security to a lower level temporarily.

## Opening Settings

- 1 Double-click the NAS Navigator2 icon (  ) to start NAS Navigator2.
- 2 Right-click your TeraStation's icon and select *Open Settings*. For macOS, select the TeraStation's icon while holding down the control key, then select *Open Settings*.

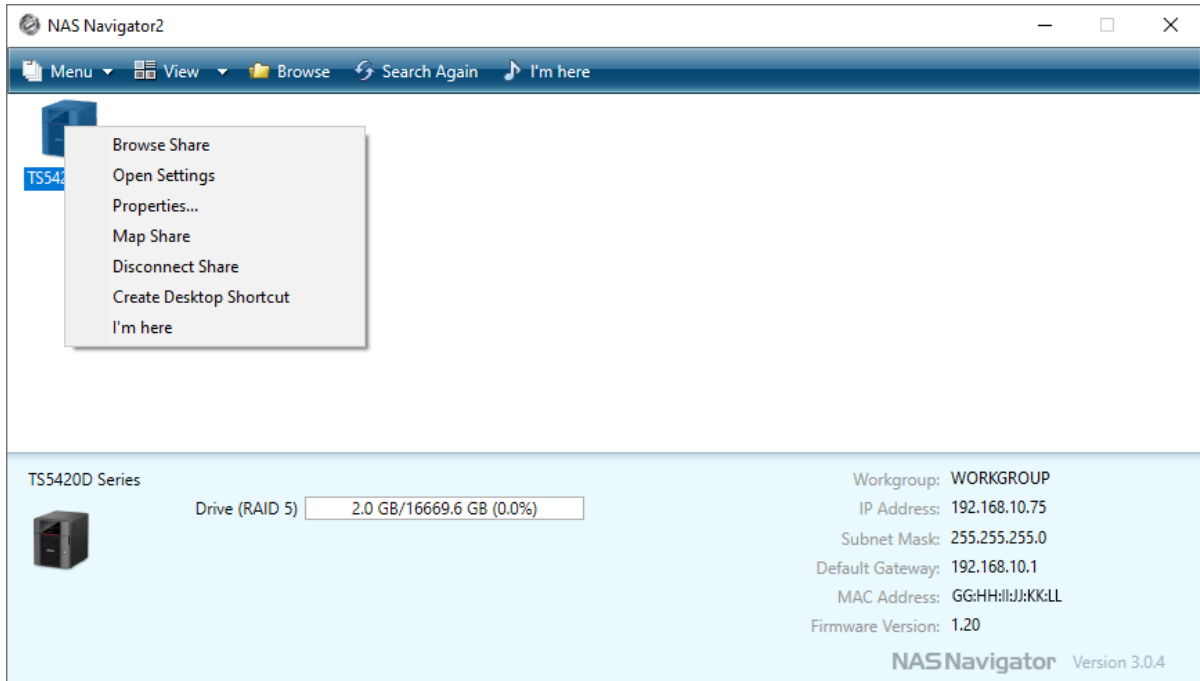

- 3 Enter the username and password, then click *OK*.

### Notes:

- If the time-out period is set to "10 minutes", you will be logged out of Settings after 10 minutes of inactivity.

- Click *Secure Connection* to log in using an encrypted connection. For detailed information about encrypted connections, refer to the [“Encrypting Data Transmission”](#) section in chapter 7.

**4** If you did not enable two-factor authentication, skip to step 5. Otherwise, refer to the authenticator app on your mobile device for the verification code. Enter the verification code and click OK.

**Note:** For detailed information about two-factor authentication, refer to the [“Two-Factor Authentication”](#) section in chapter 7.

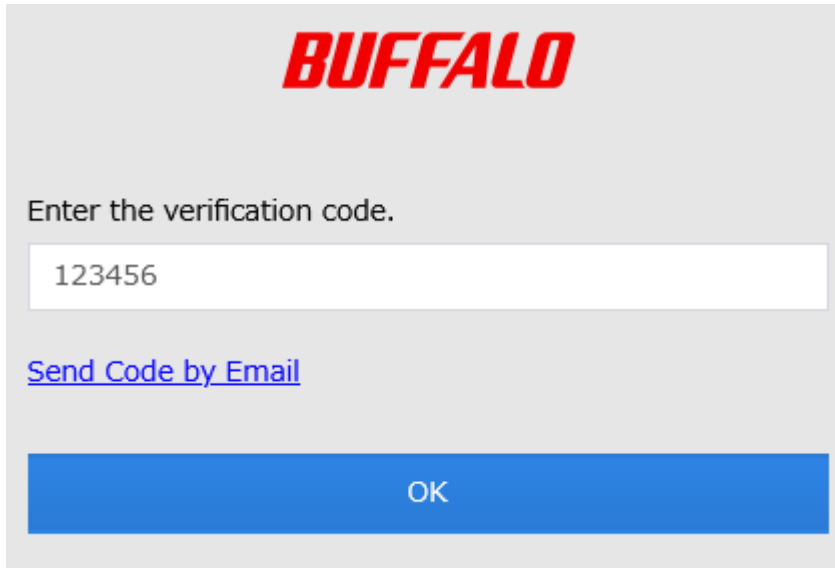

**5** The process is complete when Settings is opened.

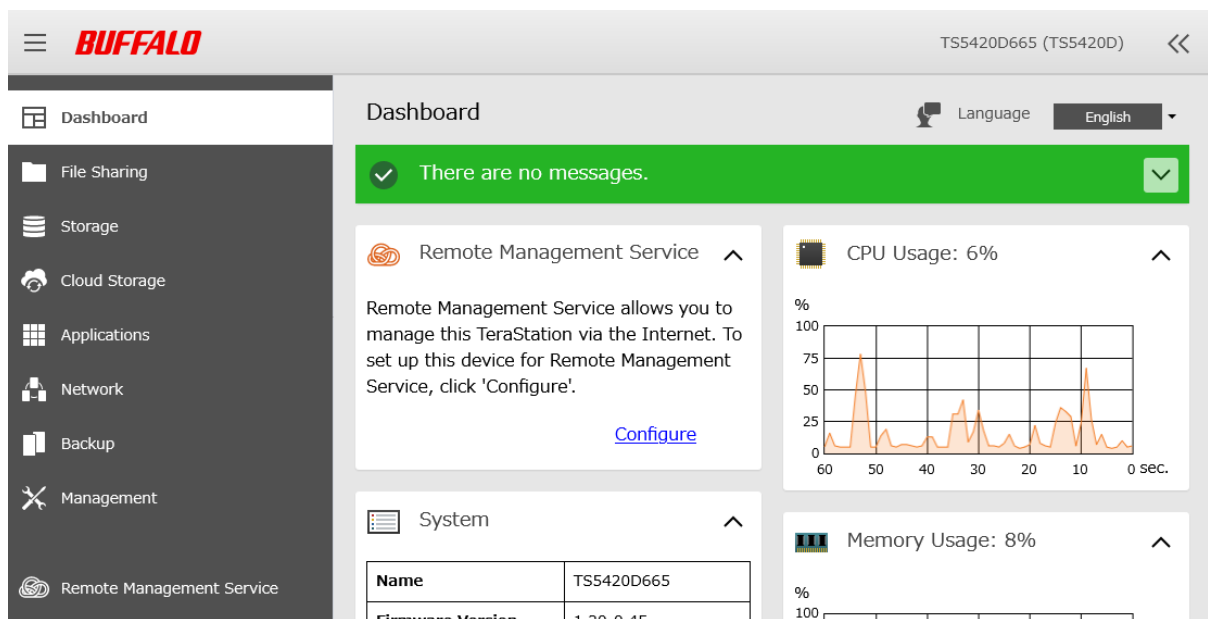

**Notes:**

- Username/Password Combinations:

Username	Password	Settings Available
admin (default)	password (default)	All
guest	blank	Guest user information

Username	Password	Settings Available
Your username	Your password	If a user is assigned as an administrator, all settings are available. If assigned to a power users group, creating or editing shared folders, users, and groups is available. If assigned to a general users group, only changing the password of logged-in users is available.

- Click  at the top-right of Settings and choose *I'm here* to have the TeraStation beep so it can be located easily.

## Configuring Settings via Setup Wizard

When you access Settings for the first time, or after initializing the TeraStation's settings, the setup wizard will automatically appear to help you configure several TeraStation settings, such as RAID mode and proxy server settings.

An example screen of the setup wizard is displayed below. Step through the wizard to configure any desired settings. If there is any setting you would like to configure later, click *Skip* to move to the next setup wizard screen, or click *Cancel* to exit the wizard. You may run the setup wizard at a later time after initial setup, or after system initialization.

### Example of Setup Wizard Screen

Administrator Password

---

**Change the administrator password.**  
For security reasons, please enter a new admin password below.

Show entered password

Password:  

Enter the password again to confirm.

Password (Confirm):

To launch the setup wizard at a later time, follow the procedure below.

- 1 From Settings, click *Management*.



- 2 Click the settings icon (  ) to the right of "Restore/Erase".



### 3 Click *Execute Wizard*.



### 4 The “Confirm Operation” screen will open. Enter the confirmation number, then click *OK*.

### 5 Follow the procedure on the screen and finish the setup wizard.

### 6 The process is complete once you close the wizard.

## Checking the Device Information from Dashboard

When opening the Settings interface, the Dashboard page will appear first. Dashboard will show the following device information:

- Notices, such as information events and errors
- System information, such as hostname, firmware version, IP address, etc.
- Drive information, such as used space of internal drives, LVM volumes, iSCSI volumes, etc.
- CPU and system memory usage
- Network information, such as IP address, link speed, sent and received rates, etc.

Name	TS5420D665
Firmware Version	1.20-0.45

#### Notes:

- If the number of files on the TeraStation increases, it will also increase the memory usage of the TeraStation. This memory usage will decrease after a certain period of time passes. To reduce the memory usage immediately, try the following operations:
  - Restarting the TeraStation.
  - Dismounting the USB drive.
- If there is not enough free space on the TeraStation, it may cause abnormal system behavior. Make sure that there is always at least 1 GB or more of free space on the TeraStation.
- You can click the *Clear* button to delete any messages from the Dashboard.

## Shutting Down or Restarting the TeraStation from Settings

You can shut down or restart the TeraStation remotely. Follow the procedure below to remotely shut down or restart the TeraStation from Settings.

- 1 Log in to Settings using NAS Navigator2.
- 2 Click  at the top-right of Settings and choose *Shut Down* or *Restart*.

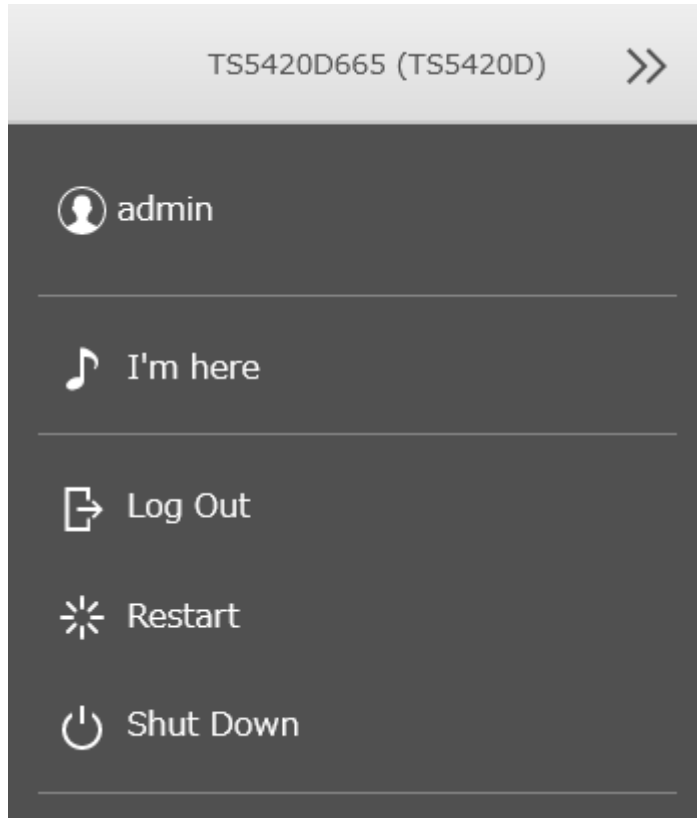

- 3 Click Yes.
- 4 The "Confirm Operation" screen will open. Enter the confirmation number, then click *OK*.
- 5 The process is complete when the power LED is extinguished if you shut down, or turns blinking to glowing if you restart.

# Chapter 3 File Sharing

You can create users and groups to access the shared folders on the TeraStation and configure access restrictions to limit access to key data.

## Configuring Shared Folders

### Adding a Shared Folder

1 From Settings, click *File Sharing*.



2 Click the settings icon (  ) to the right of "Folder Setup".



3 Click *Create*.

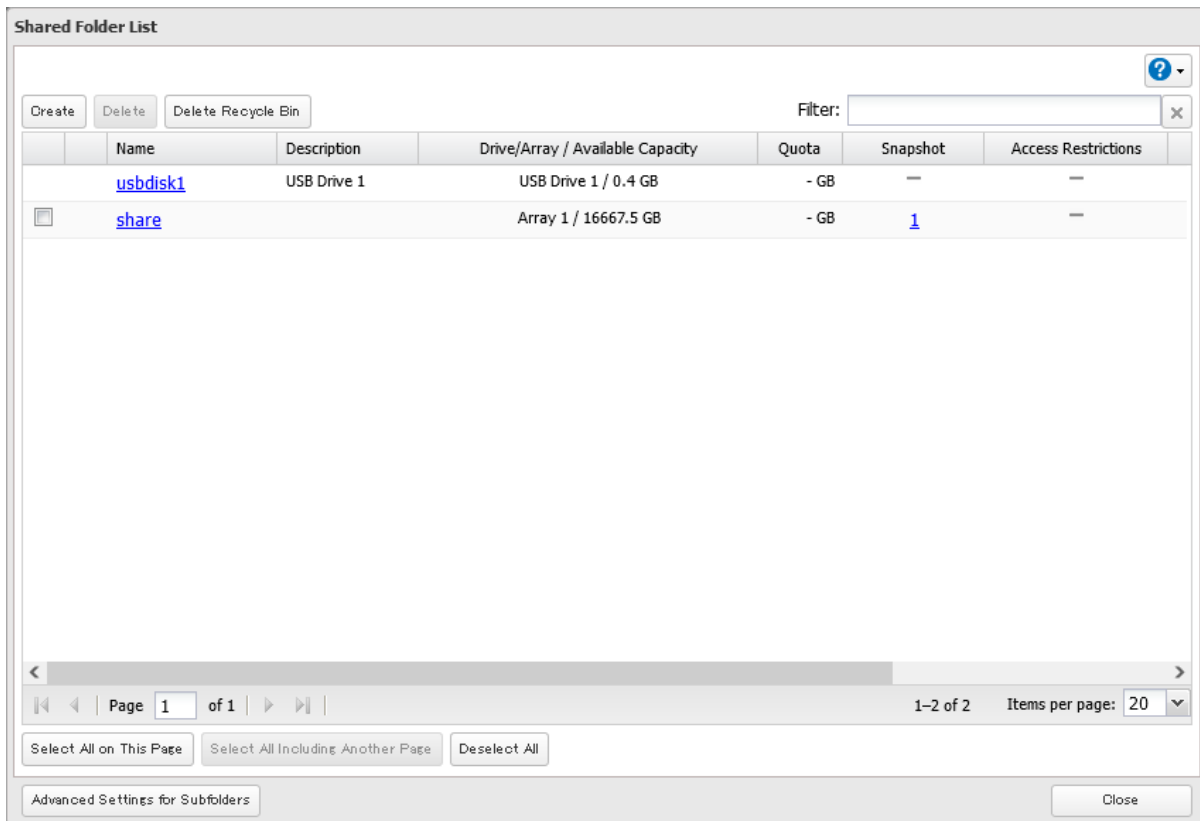

#### 4 Configure the desired settings, then click *OK*.

**Shared Folder Settings** \*Required ?

**Basic** | Option 1 | Option 2 | Access Restrictions

Copy Settings from:

Name \* :

Drive/Array:

Recycle Bin:  Enable  Disable

LAN Protocol Support:  SMB (Windows/Mac)  Backup

FTP  WebAccess

SFTP

NFS

— NFS Path \_\_\_\_\_

OK Cancel

#### 5 The process is complete once you close the confirmation window that appears.

##### Notes:

- Names may contain up to 27 alphanumeric characters, hyphens (-), and underscores (\_). Multibyte characters are supported. The first character should not be a symbol.
- When you click the *Option 1* tab, you can enter the folder description. Descriptions may contain up to 75 alphanumeric characters, hyphens (-), underscores (\_), and spaces. Multibyte characters are supported. The first character should not be a space.
- You may create up to 400 shared folders.
- If the names of shared folders accessed via FTP connections contain multibyte characters, configure the client language in *Management > Name/Time/Language* to match the characters. If the setting and display language do not match, the shared folder name will not be displayed correctly.
- The following characters are handled differently by macOS and Windows devices. Avoid using these characters when sharing data between macOS and Windows devices:  
— ~ // - ¢ £ ¬
- Windows does not support some characters that macOS and the TeraStation allow. If you create a filename on a macOS device that includes any of the following symbols, it will not display correctly on a Windows computer.  
?][/\=+><;: ",|\*
- Do not use a name already in use as an iSCSI volume name; do not use any of the following words for the name of a shared folder as these words are reserved for internal use by the TeraStation: *authstest*, *global*, *homes*, *info*, *lost+found*, *lp*, *msdfs\_root*, *mt-daapd*, *printers*, *ram*, *spool*, *usbdisk x* (where “x” is a number, for example: *usbdisk1*)
- Don’t use the following unsupported characters in shared folder names, workgroup names, or filenames:



**Notes:**

- Configure the share attribute only through Settings. Configuring folder attributes through Windows is not supported and may cause unexpected behavior.
- To set a read-only share or USB drive to another attribute, follow the procedure above and change the attribute in step 2 from “Read only” to the desired attribute.

## Hidden Shares

---

If a shared folder becomes hidden, it will not be displayed under Network, and only certain users will be allowed to access it. To hide a shared SMB folder, follow the procedure below.

- 1** From Settings, navigate to *File Sharing > Folder Setup* and choose a shared folder to make hidden.
- 2** Click the *Option 2* tab and select the “Hidden share (SMB only)” checkbox, then click *OK*.
- 3** The process is complete once you close the confirmation window that appears.

**Notes:**

- If protocols other than “SMB (Windows/Mac)” or “Backup” under “LAN Protocol Support” on the *Basic* tab are enabled, the hidden shares option will be grayed out and cannot be selected.
- Configure hidden share attributes only through Settings. Configuring them through Windows is not supported and may cause unexpected behavior.

To access a hidden folder, open File Explorer in your computer and enter “\\TeraStation name\shared folder name\$” into the address bar. For example, if the TeraStation name is “TSXXX001” and the shared folder name is “share”, enter “\\TSXXX001\share\$” to open it.

---

## Configuring Users

---

### Adding a User

---

**Note:** You may add up to 300 users, which include the default users “admin” and “guest”.

- 1** From Settings, click *File Sharing*.

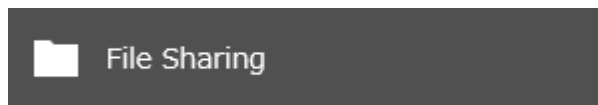

- 2** Click the settings icon (  ) to the right of “Users”.



### 3 Click Create.

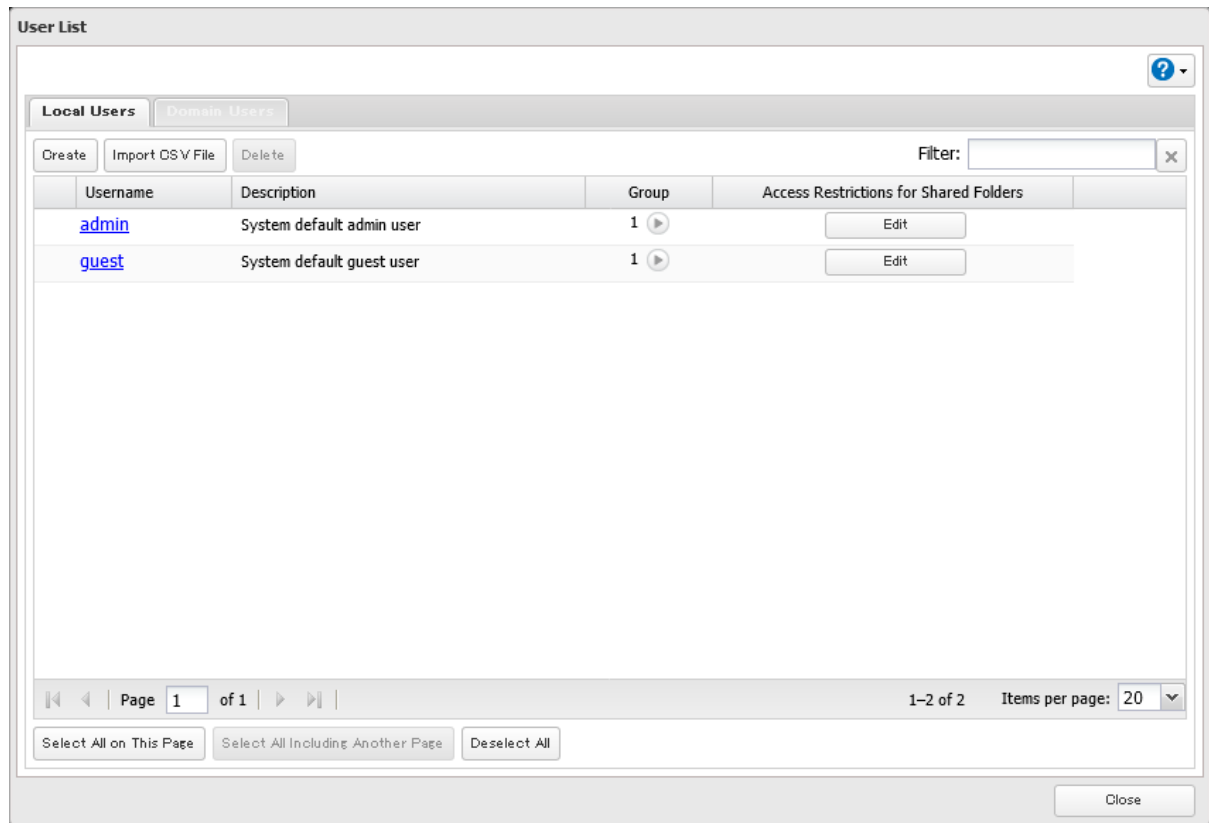

#### 4 Enter the desired settings, then click *OK*.

**User Settings**

\*Required ?

Username \* :

User ID:  
Enter a number between 1000 and 1999.

Email Address:

Password \* :

Password (Confirm) \* :

Description:

Filter: [ ]

Group
<input checked="" type="checkbox"/> hdusers
<input type="checkbox"/> admin

Select All Deselect All

Primary Group:  
hdusers

OK Cancel

#### 5 The process is complete once you close the confirmation window that appears.

##### Notes:

- Usernames may contain up to 128 alphanumeric characters, hyphens (-), underscores (\_), periods (.), and the symbols ! # & @ \$ \* ^ %. The first character should not be a symbol.
- The user ID should be a number from 1000 to 1999. Each user ID should be unique. If this field is left blank, a user ID is assigned automatically.
- Do not duplicate user IDs, group IDs, usernames, or group names. Each should be distinct and unique.
- User descriptions may contain up to 75 alphanumeric characters, hyphens (-), underscores (\_), and spaces. Multibyte characters are supported. The first character should not be a symbol or space.
- Passwords may contain up to 20 alphanumeric characters, hyphens (-), underscores (\_), spaces, commas (,), periods (.), semicolons (;), tildes (~), and the symbols ! # & @ \$ \* ^ % + = ? ] [ } { \. The first character should not be a symbol unless it is an underscore.
- Use the same username and password for both Windows and the TeraStation or you may be unable to access shared folders.
- Do not use a name already in use as a group name; do not use any of the following words as a username as these words are reserved for internal use by the TeraStation: \_lldpd, adm, admin, administrator, admins, all, apache, audio, avahi, avahi-autoipd, backup, bin, cdrom, crontab, daemon, dialout, dip, disk, fax, floppy, ftp, ftpuser, fuse, games, gnats, guest, guests, halt, hdusers, irc, kmem, libuuid, list, lp, mail, man, messagebus, mysql, netdev, news, nobody, nogroup, none, ntp, openldap, operator, plugdev, proftpd, proxy, puppet, root, rpc, rpcuser, sambashare,

sasl, shadow, shutdown, snmp, splx, src, ssh, sshd, staff, statd, sudo, sync, sys, syslog, tape, tmhttpd, tty, users, utmp, uucp, video, voice, winbindd\_priv, www, www-data

## Importing User Information

---

You can import users in *File Sharing > Users* by clicking *Import CSV File*.

An example format for user data: Username (required), password (required), and user description (optional).

Example 1: Importing usernames, passwords, and comments

```
username1,password1,comment1  
username2,password2,comment2  
username3,password3,comment3
```

Example 2: Importing usernames and passwords

```
username1,password1,  
username2,password2,  
username3,password3,
```

### Guidelines:

- Use commas (,) as separators. Do not put spaces before or after commas. If you don't want user descriptions, use a comma after the password at the end.
- If a line is in an incorrect format, the username entered on that line will not be registered.
- If an unavailable name is used by a user or if the username already exists, an error will occur and cancel the import process. User whose usernames were entered during or after the error occurs will not be imported.
- Do not use commas (,) in the username, password, or user description.

**Note:** Imported users are added to the "hdusers" group automatically.

---

## Adding a Group

---

**Note:** You may add up to 300 groups.

- 1** From Settings, click *File Sharing*.

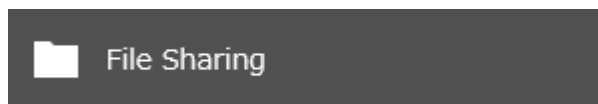

- 2** Click the settings icon (  ) to the right of "Groups".



### 3 Click Create.

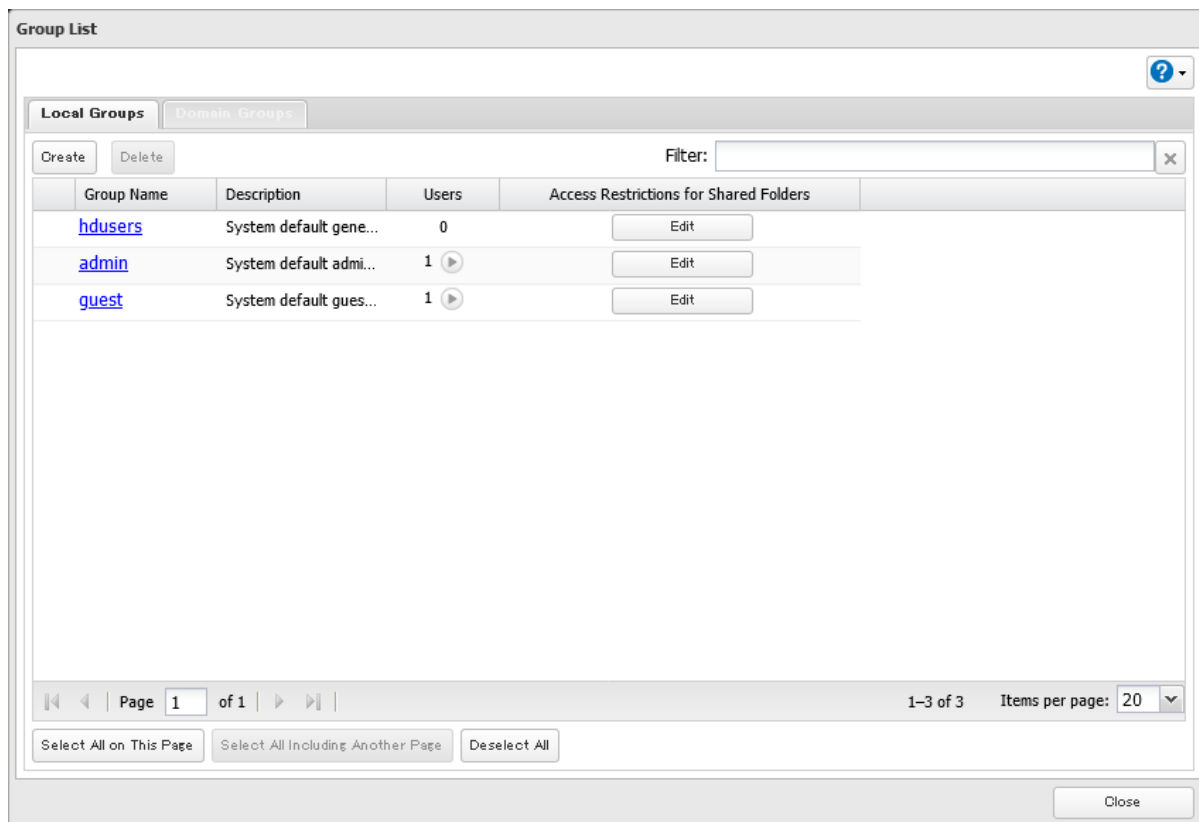

#### 4 Enter the desired settings, then click *OK*.

**Group Settings**

**Group Name \* :**

**Group ID:**  
Enter a number between 1000 and 1999.

**Group Privileges:**  
General users

**Notifications Recipient:**  
 User (with email address configured)  
 Email address

Disabled

**Description:**

Filter:

Username
<input type="checkbox"/> admin

Select All Deselect All

OK Cancel

#### 5 The process is complete once you close the confirmation window that appears.

##### Notes:

- Group names may contain up to 20 alphanumeric characters, hyphens (-), underscores (\_), and periods (.). The first character should not be a symbol.
- Group descriptions may contain up to 75 alphanumeric characters, hyphens (-), underscores (\_), and spaces. Multibyte characters are supported. The first character should not be a symbol or space.
- If the group ID field is left blank, a group ID is automatically assigned. Use numbers between 1000 and 1999 to set a group ID manually. Don't use duplicate group IDs.
- If you are logged in as an administrator, you can change any setting, including other users' passwords. If you are logged in as a member of the power users group, you can create and edit shared folders, users, and groups. If you are logged in as a member of the general users group, you can only change your own password.
- Do not use a name in use as a username; do not use any of the following words as a group name as these words are reserved for internal use by the TeraStation: \_lldpd, adm, admin, administrator, admins, all, apache, audio, avahi, avahi-autoipd, backup, bin, cdrom, crontab, daemon, dialout, dip, disk, fax, floppy, ftp, ftpuser, fuse, games, gnats, guest, guests, halt, hdusers, irc, kmem, libuuid, list, lp, mail, man, messagebus, mysql, netdev, news, nobody, nogroup, none, ntp, openldap, operator, plugdev, proftpd, proxy, puppet, root, rpc, rpcuser, sambashare, sasl, shadow, shutdown, snmp, splx, src, ssh, sshd, staff, statd, sudo, sync, sys, syslog, tape, tmhttpd, tty, users, utmp, uucp, video, voice, winbindd\_priv, www, www-data

## Configuring Access Restrictions

You may restrict access for specific shared folders, including external USB drives.

### Notes:

- Configure access restrictions only through Settings. Configuring access restrictions through Windows is not supported and may cause unexpected behavior.
- Shared folders with limited access can still be used as backup destinations.
- If you grant both read-only and read and write access to the users or groups, the attributes will become as below:

	Group with read and write access	Group with read-only access	Group with no access
User with read and write access	R/W	R	R/W
User with read-only access	R	R	R
User with no access	R/W	R	-

R/W: Read and write, R: Read-only, -: No access

- If you change access restrictions for a user or group while they are accessing files, unexpected behavior may occur.

## Restricting Local User Access to Shared Folders

- 1 From Settings, click *File Sharing*.

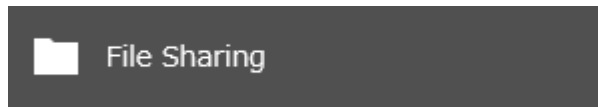

- 2 Click the settings icon (  ) to the right of "Folder Setup".



**3** Click the shared folder that you want to set access restrictions for.

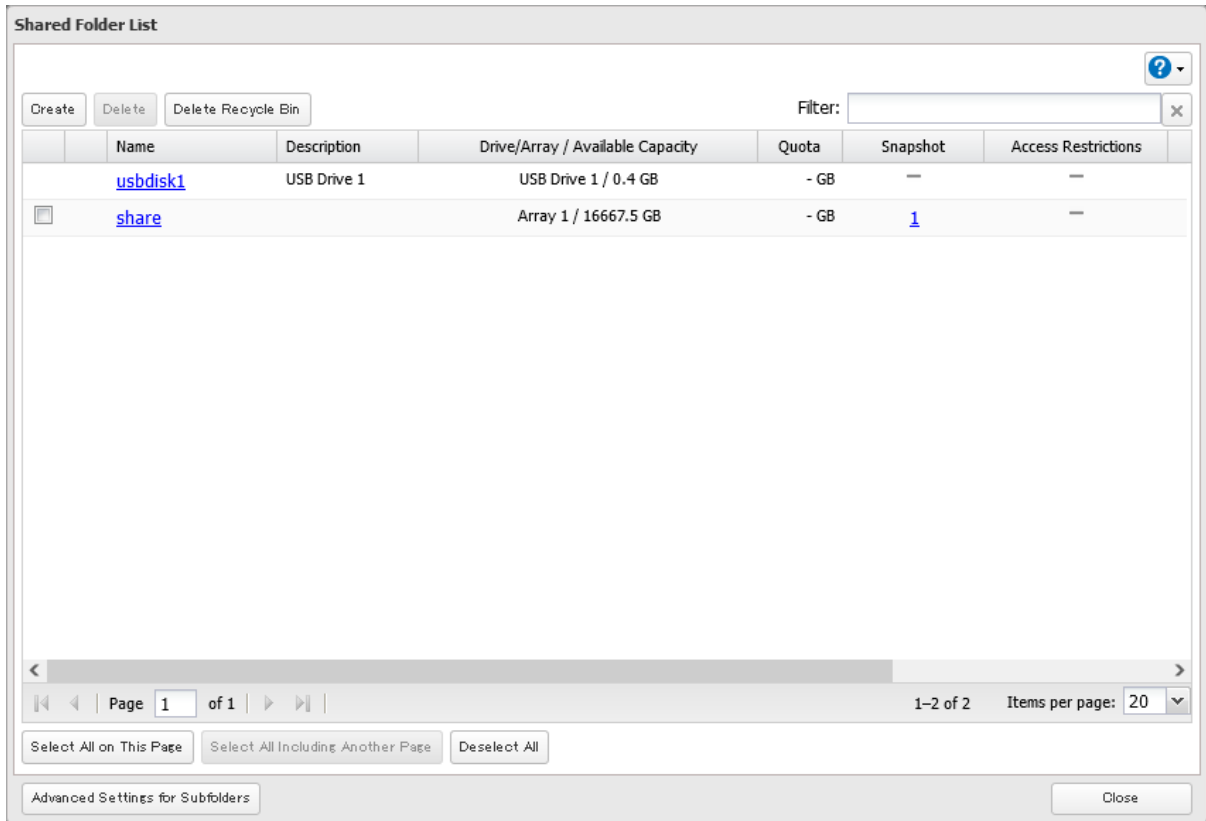

**4** Click the *Access Restrictions* tab.

**5** Enable “Access Restrictions for Shared Folders”.

Access Restrictions for Shared Folders:  Enable  Disable

**6** Select the level of access for the user or group and click *OK*.

: Read and write    : Read-only    : No access

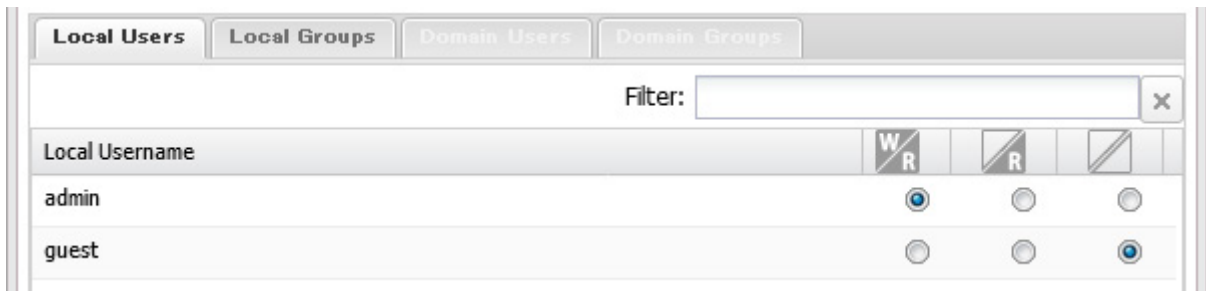

**Note:** The example above shows access restrictions by users. To restrict access by group, click the *Local Groups* tab and select group permissions.

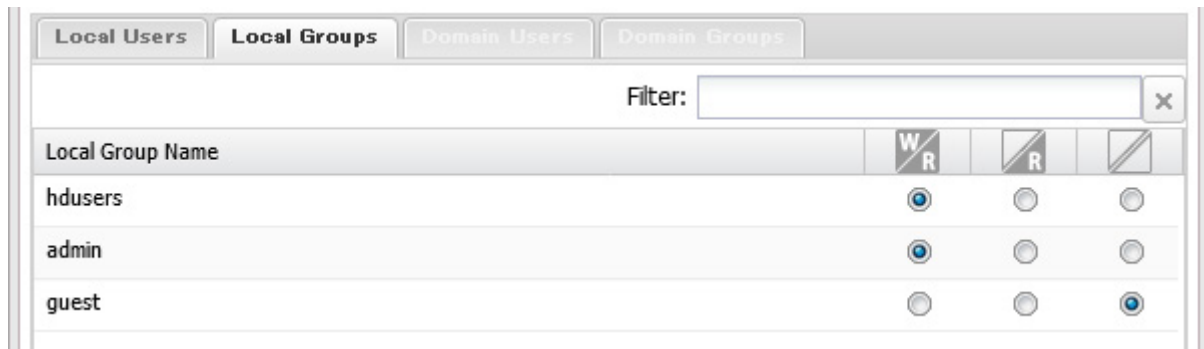

**7** The process is complete once you close the confirmation window that appears.

**Note:** For an access-restricted shared folder, if you change the access restrictions of all users and groups from read and write or read-only to access prohibited from the user or group list page in Settings, that shared folder can only be accessed by admin users and groups.

## Restricting AD Domain User Access to Shared Folders

If there is an Active Directory environment, the TeraStation will use account information from the Active Directory domain controller to set access restrictions for shared folders on the TeraStation. There is no need to perform individual account management for the TeraStation. If multiple TeraStations are installed on the network, the account information will be centrally managed in Active Directory, greatly reducing the operations required for installation and management.

### Notes:

- If usernames or group names from Active Directory include multibyte characters, you will not be able to configure access restrictions for them.
- The TeraStation supports an Active Directory domain environment with a maximum of 10,000 users and groups total.

**1** From Settings, click *Network*.



**2** Click the settings icon (  ) to the right of "Workgroup/Domain".



**3** Click *Edit*.

- 4** Select “Active Directory”, then click *Next*.

**Workgroup/Domain Settings**

Authentication Method

Workgroup

Active Directory

Next Cancel

- 5** Enter the domain controller information and click *Search*. The domain controller on the same network will be detected and required settings will be populated into each field automatically. Alternatively, you can also manually enter the settings.

**Active Directory Domain Settings**

\*Required

Detect Domain Controller :  Search  
(IP Address, DNS Name, or Computer Name)

NetBIOS Name \* :

DNS Name \* :

Domain Controller Name \* :   
(Computer Name)

Administrator Name \* :

Administrator Password \* :

WINS Server IP Address:

Configure domain controller as an NTP server

OK Cancel

- 6** If there is a difference of more than five minutes between the TeraStation’s clock and the domain controller’s clock, joining the domain or authenticating domain users and groups may fail. For best results, select “Configure domain controller as an NTP server” if the domain controller can function as the NTP server.

- 7** Click *OK*.

- 8** From Settings, click *File Sharing*.

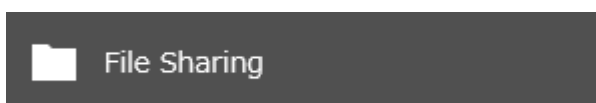

9 Click the settings icon (  ) to the right of “Folder Setup”.



10 Click the shared folder that you want to set access restrictions for.

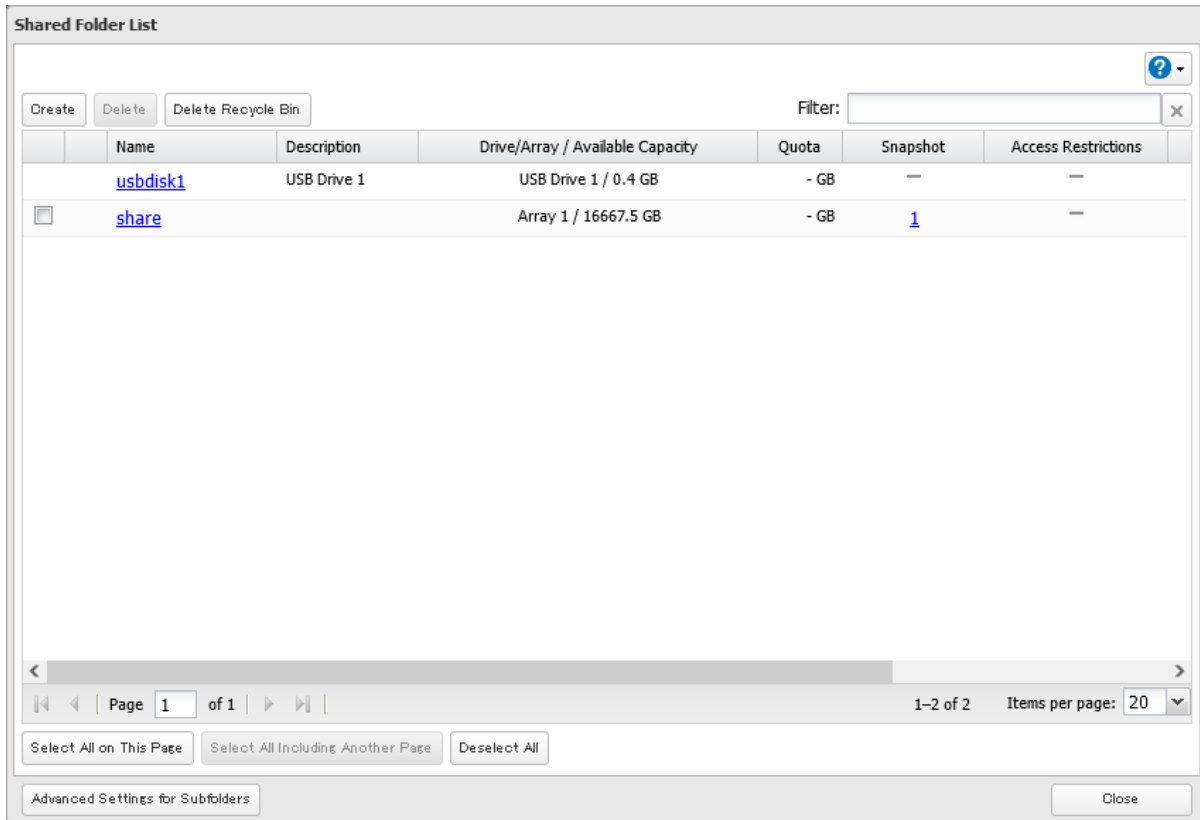

11 Click the *Access Restrictions* tab.

12 Enable “Access Restrictions for Shared Folders”.

Access Restrictions for Shared Folders:  Enable  Disable

13 Select the level of access for the user or group and click *OK*.

 : Read and write   : Read-only   : No access

14 The process is complete once you close the confirmation window that appears.

#### Notes:

- To have the TeraStation join an Active Directory domain, configure it to use a DNS server that can resolve names for the Active Directory domain.
- After building an Active Directory domain, the administrator password for joining the domain must be changed at least once, or joining the Active Directory domain will fail.
- The DNS name and NetBIOS name of Active Directory domains should be identical.
- If your TeraStation is a member server in an Active Directory domain and you change the authentication method to “Workgroup”, the account on the domain controller will not be deleted automatically.

- If FTP is enabled, local and domain group access restrictions from the AD network will not work. Use user access restrictions instead.
- For an access-restricted shared folder, if you change the access restrictions of all users and groups from read and write or read-only to access prohibited from the user or group list page in Settings, that shared folder can only be accessed by admin users and groups.
- If you allow read and write or read-only access for most users, group access restrictions are recommended.
- Depending on the domain controller's policy settings, the domain controller may force the TeraStation to leave the Active Directory domain. If this occurs, the TeraStation will lose the domain users and groups so if you have configured access restrictions using domain accounts, these users will no longer be able to access shared folders. In such a case, change the policy settings on the domain controller or let the TeraStation join the Active Directory domain again.
- If there is a local user with the same name as a domain user, access restrictions may not work properly.

## Restricting Access to Subfolders

---

You may restrict access to subfolders in shared folders by configuring access permissions from your computer using Windows File Explorer.

### Notes:

- Depending on the environment, the function may not work properly when enabled. We recommend verifying the functionality before using.
- Access permissions configuring from File Explorer is available for up to 18 files and 24 folders. This number of available access permissions may vary if access permissions are inherited from the parent object.

The number of available access permissions are not many so using group access permissions is recommended if the permission level is the same to the multiple users; it will save spending the number of available access permissions.

**1** From Settings, click *File Sharing*.

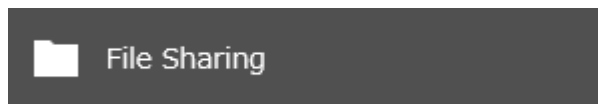

**2** Click the settings icon (  ) to the right of "Folder Setup".



**3** Click the shared folder that you want to set access restrictions for.

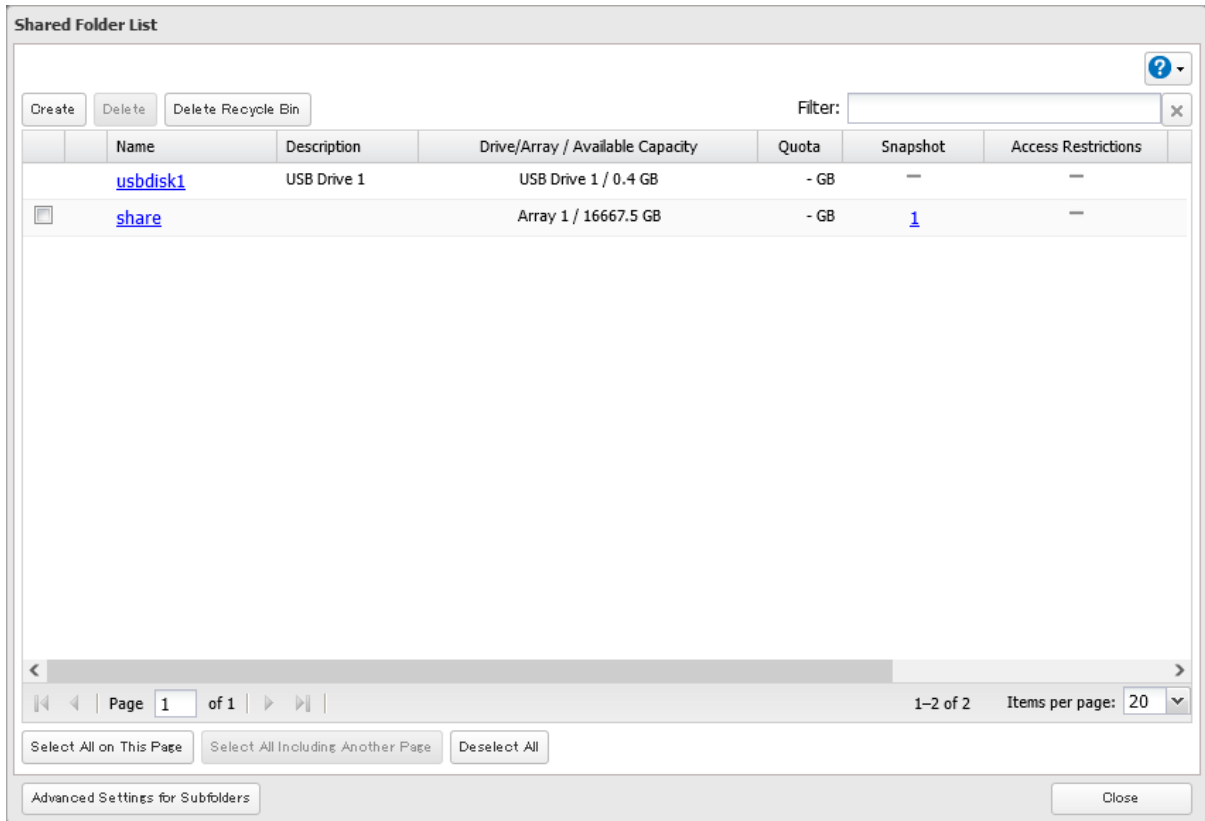

**4** If either or both of the “FTP” and “SFTP” checkboxes for “LAN Protocol Support” are selected, clear them all.

**5** Click the *Option 2* tab.

**6** Enable “Access Restrictions for Subfolders” and click *OK*.

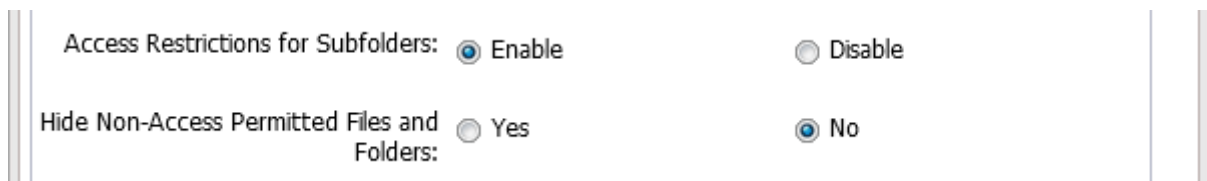

**Note:** If “Hide Non-Access Permitted Files and Folders” is enabled, non-access permitted sub-files and folders will not be displayed in shared folders.

**7** The process is complete once you close the confirmation window that appears.

Enabling subfolders’ access restrictions finished. Next, configure access permissions for each user or group to files and folders in subfolders from File Explorer.

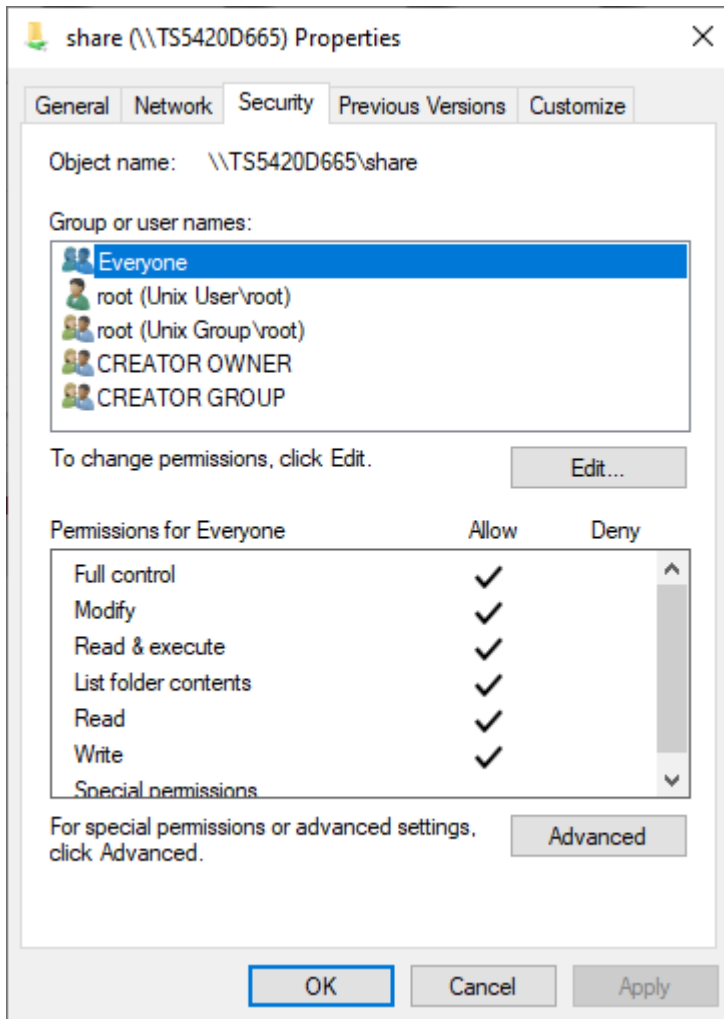

You may also configure access permissions for domain users and groups. You should have the TeraStation join your Active Directory domain before configuring access permissions from File Explorer.

**Notes:**

- If enabling subfolders' access restrictions for a USB drive, the drive should be formatted using Btrfs, XFS, or ext3.
- To back up or replicate files to backup or replication destinations while leaving access permissions of files and folders in subfolders unchanged, make sure the same workgroup name, user IDs, and group IDs are configured between backup or replication sources and destinations.
- If you enable subfolders' access restrictions and then clear the "Read & execute" checkbox under "Allow" on File Explorer for users or groups access permissions, these users or groups cannot be allowed to read and execute even if subfolders' access restrictions are disabled in Settings. If you deny reading and executing on the same window, this will remain after disabling subfolders' access restrictions.
- If the TeraStation's settings have been initialized but you configure the same UID and GID for new users and groups, access permissions to files and folders in subfolders may be inherited.

---

## Enhancing Compatibility for macOS Client Access

---

To access shared folders via SMB connections from macOS devices, configure access from macOS devices to be enhanced over other clients such as Windows devices. By enabling this setting, file transfer speed from macOS devices will be increased, while the CPU usage rate of this TeraStation will decrease. However, the file transfer speed for non-macOS SMB clients will drop slightly.

1 From Settings, click *File Sharing*.



2 Click the settings icon (  ) to the right of "SMB".



3 Click *Edit*.

4 Enable "Enhanced Compatibility with macOS Clients", then click *OK*.

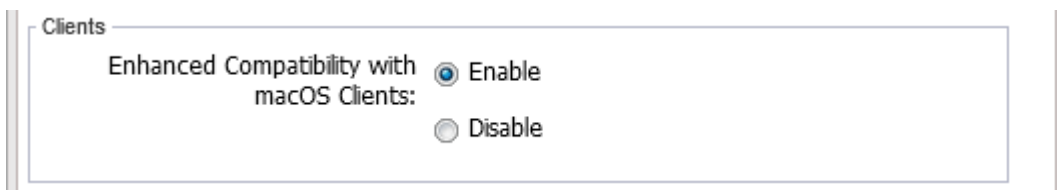

5 The process is complete when the file sharing menu list is displayed.

---

## NFS

---

**Note:** Buffalo's customer support will help configure the NFS settings on your TeraStation, and will support VMware and Windows clients but will not provide support for configuring your Linux or other UNIX clients. There are various types of UNIX and the procedures for configuring NFS with them will vary considerably. For help configuring your NetWare, Linux, or other UNIX clients for NFS support, please consult each client's own documentation and support.

### Enabling NFS

---

Follow the procedure below to enable NFS service to allow access from NFS clients.

1 From Settings, click *File Sharing*.

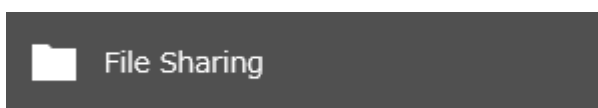

2 Click the settings icon (  ) to the right of "Folder Setup".



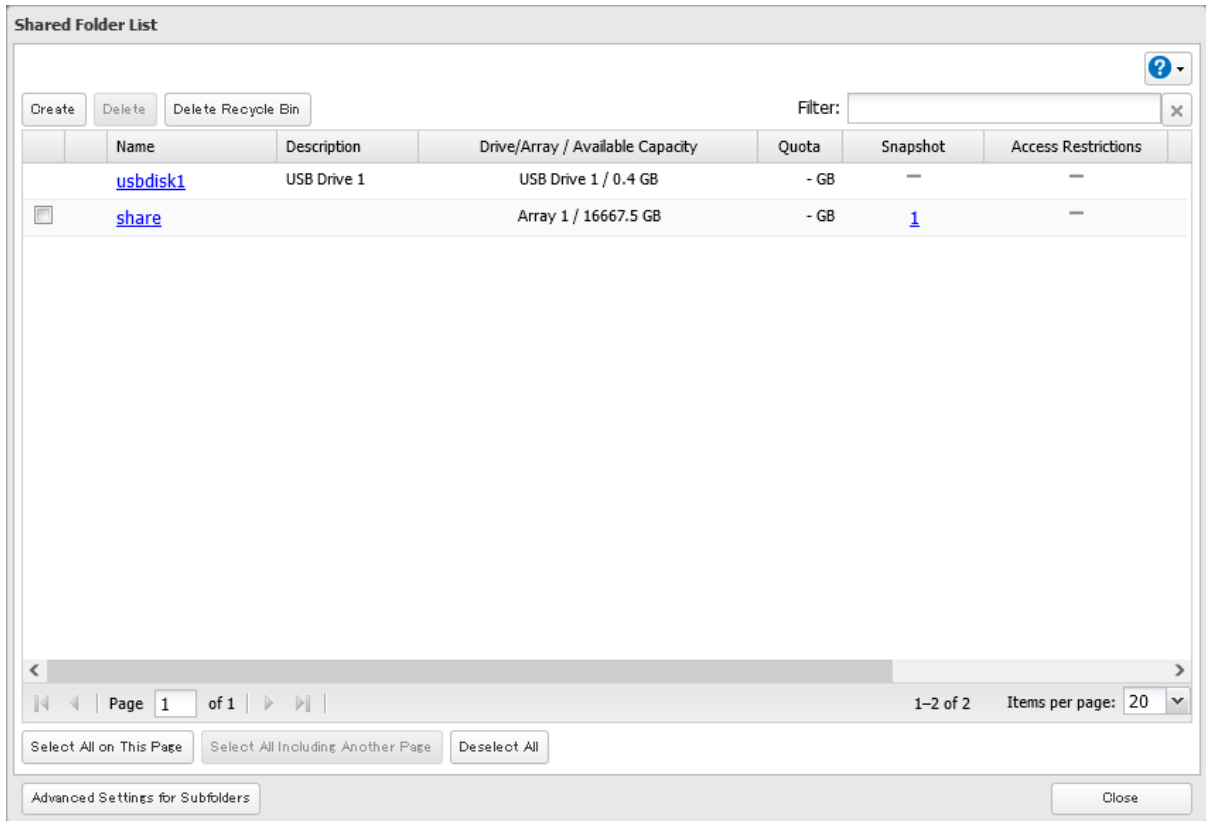

**3** Choose the shared folder that will be accessible from the NFS client.

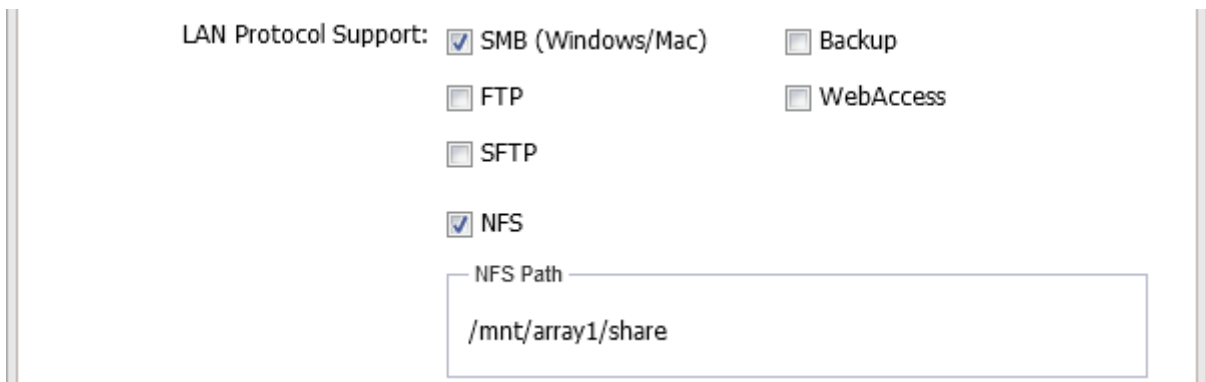

**4** Under “LAN Protocol Support”, select the “NFS” checkbox on the *Basic* tab and click *OK*. Note the NFS path. It will be used later for accessing data from an NFS client.



**5** Click *Close*.

**6** Move the NFS switch (  ) to the  position to enable NFS.



**7** Click the settings icon (  ) to the right of “NFS”.



8 Click the *Clients* tab.

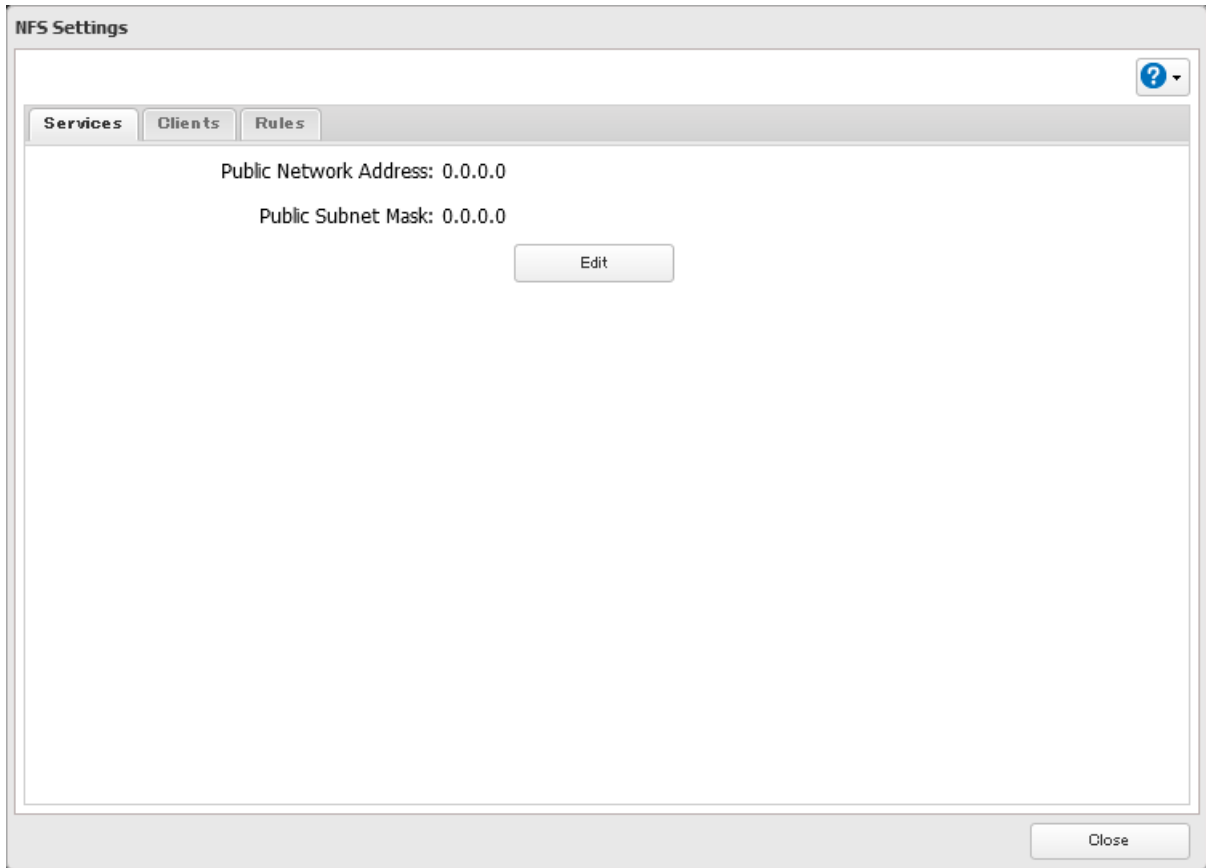

9 Click *Add*.

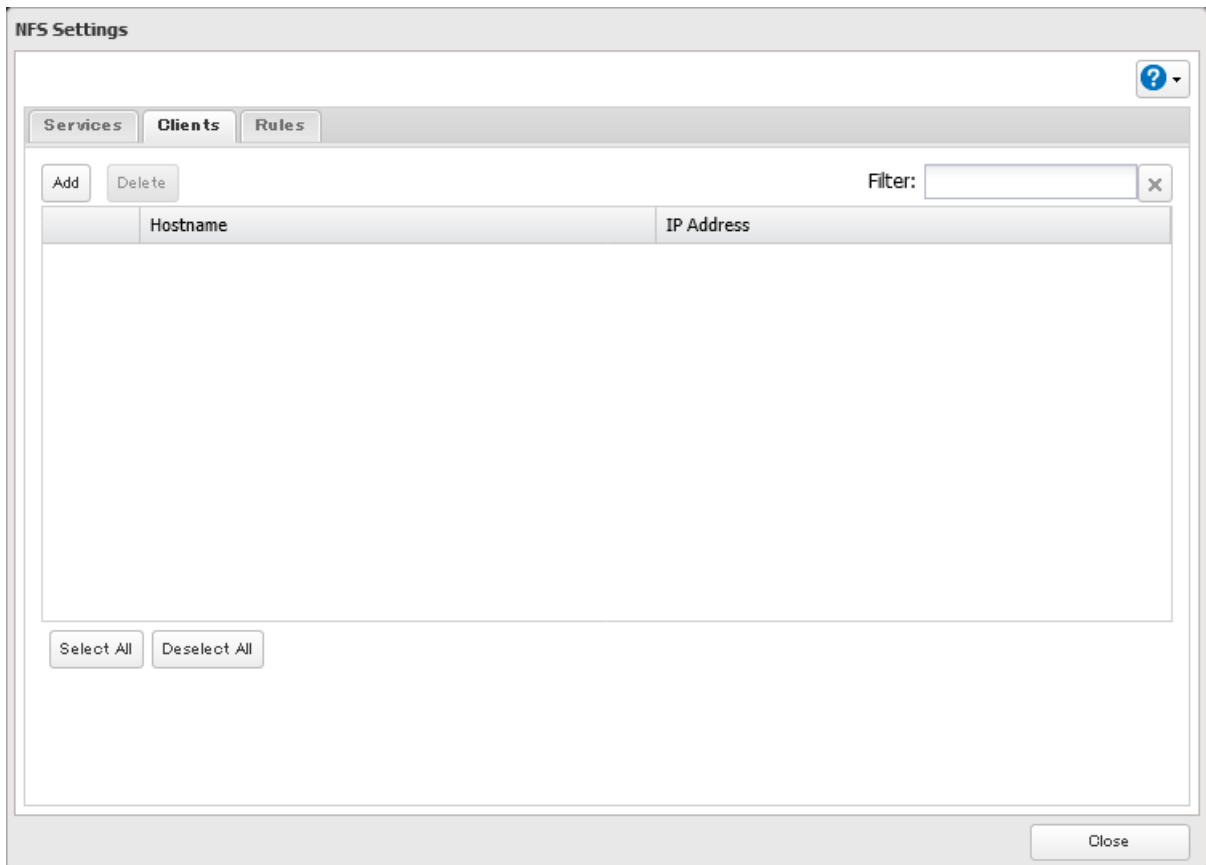

- 10** Enter the hostname and IP address of the NFS client, then click *OK*. You should add all NFS clients to access the shared folder.

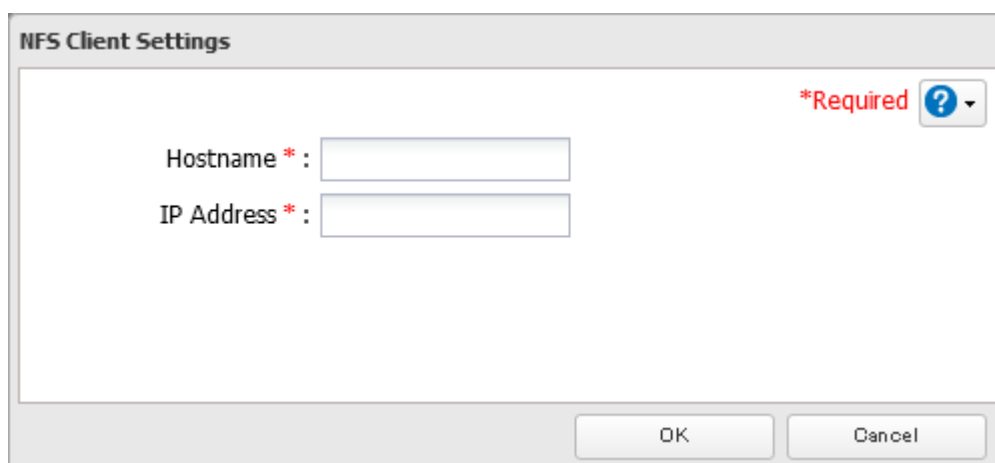

The **NFS Client Settings** dialog box contains two input fields: **Hostname \*** and **IP Address \***. A red asterisk and the word **\*Required** are positioned to the right of the fields. A help icon (a question mark in a blue circle) is located in the top right corner. At the bottom of the dialog are **OK** and **Cancel** buttons.

- 11** Click the *Rules* tab.

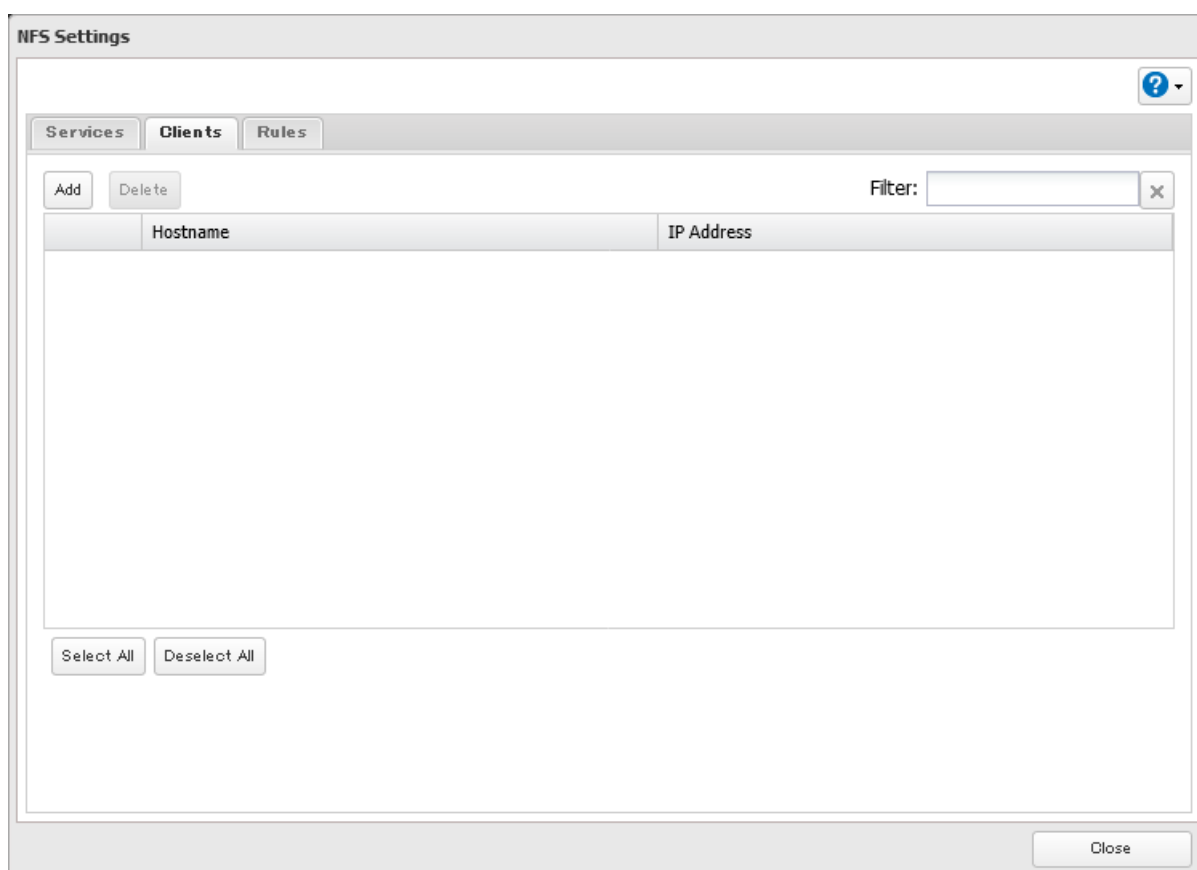

The **NFS Settings** dialog box features three tabs: **Services**, **Clients**, and **Rules**. The **Rules** tab is selected. Above the table are **Add** and **Delete** buttons, and a **Filter:** input field with a clear button (X). The table has two columns: **Hostname** and **IP Address**. Below the table are **Select All** and **Deselect All** buttons. A **Close** button is located at the bottom right of the dialog.

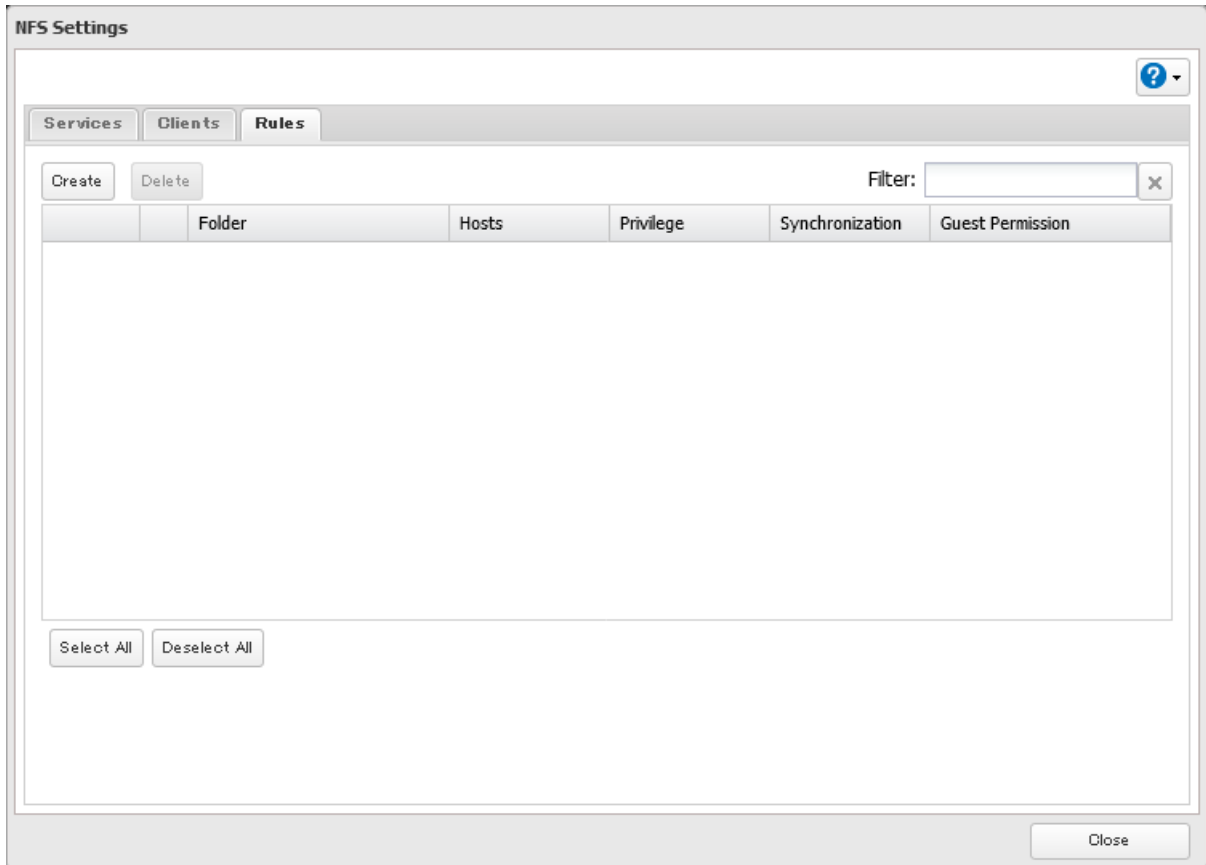
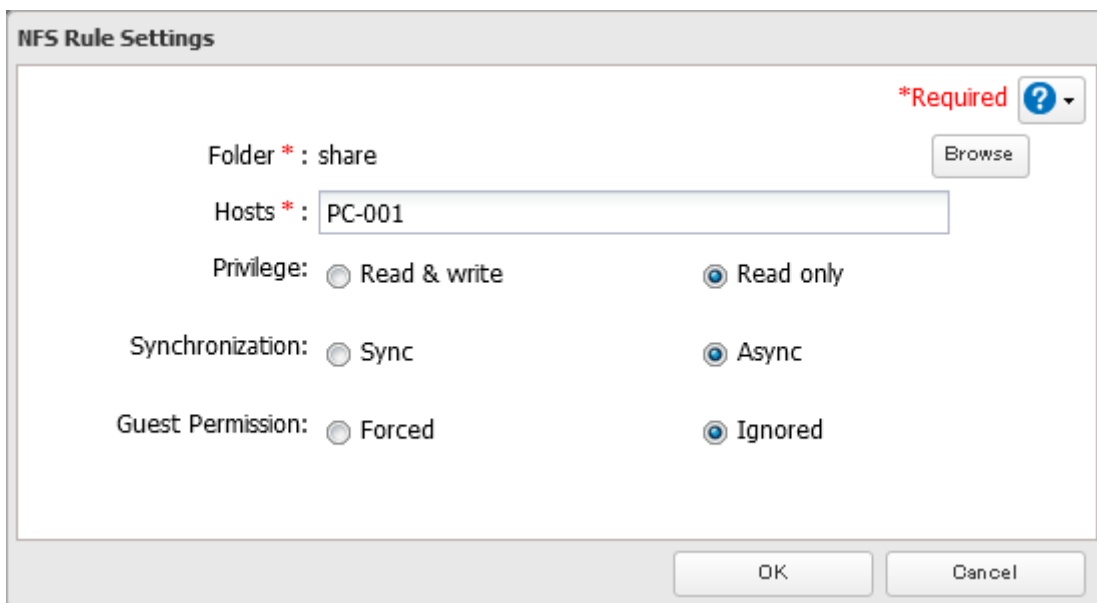
**12** Click *Create*.**13** Choose the folder to restrict access to, and enter the clients that will have restricted access into the “Hosts” field. Clients may be entered by hostname, IP address, or IP address range. Wildcards are supported. Separate multiple entries with commas. You may assign read-only or read and write access to the listed clients. Rules override any settings made from the *Services* tab.**14** Click *OK*. The process is complete once you close the confirmation window that appears.

**Notes:**

- To restrict NFS access to a specific network or client, navigate to *File Sharing > NFS > Services* and click *Edit*. Enter the address of the network. For example, if your local network subnet has a router at 192.168.1.1 and clients with IP addresses in the range from 192.168.1.2 through 192.168.1.48 with subnet mask 255.255.255.0, then the “Public Network Address” would be 192.168.1.0 and the “Public Subnet Mask” would be 255.255.255.0. This would mean that only clients on this local network would be able to access the NFS share. If the default settings are used (0.0.0.0 for both the public network address and the public subnet mask), then access to the NFS share will not be restricted.
- If you configure “Guest Permission” to “Forced” on the screen after navigating to *Rules > Add*, the user ID and group ID should be 65534 when the data is written from NFS clients; this is recommended for SMB and other protocols as well. If the TeraStation only enables the NFS connection, select “Ignored” instead.
- Be aware that some NFS clients may be able to access via NFS although the clients do not exist in the allowed NFS client list.

## NFS Mount Commands

---

Enter the mount command to access the shared folder from the NFS client. The mount command depends on your operating system. The examples below assume that IP address of your TeraStation is 192.168.11.10, “/mnt/array1/share” is the desired NFS path, and “/mnt/nas” or drive letter “z” is the mount point.

**For Linux:**

```
mount -t nfs 192.168.11.10:/mnt/array1/share /mnt/nas
```

**For Windows Service for Unix 3.5:**

```
mount 192.168.11.10:/mnt/array1/share z:
```

**Note:** A shared folder whose folder name contains multibyte characters cannot be accessed.

**For Solaris 10:**

```
mount -F nfs 192.168.11.10:/mnt/array1/share /mnt/nas
```

**For macOS:**

```
sudo mount -t nfs -o resvport 192.168.11.10:/mnt/array1/share /mnt/nas
```

## Offline Files for Windows

---

The “offline files” feature that is included with many versions of Windows can be used with files on the TeraStation. You will be able to work on files stored on the TeraStation even when your PC is disconnected from the network. When you next connect to the network, the updated files are written and synchronized. Follow the procedure below to configure offline files.

- 1 From Settings, click *File Sharing*.

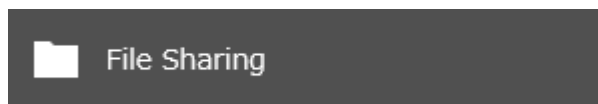

- 2 Click the settings icon (  ) to the right of “Folder Setup”.



### 3 Click the shared folder for offline files.

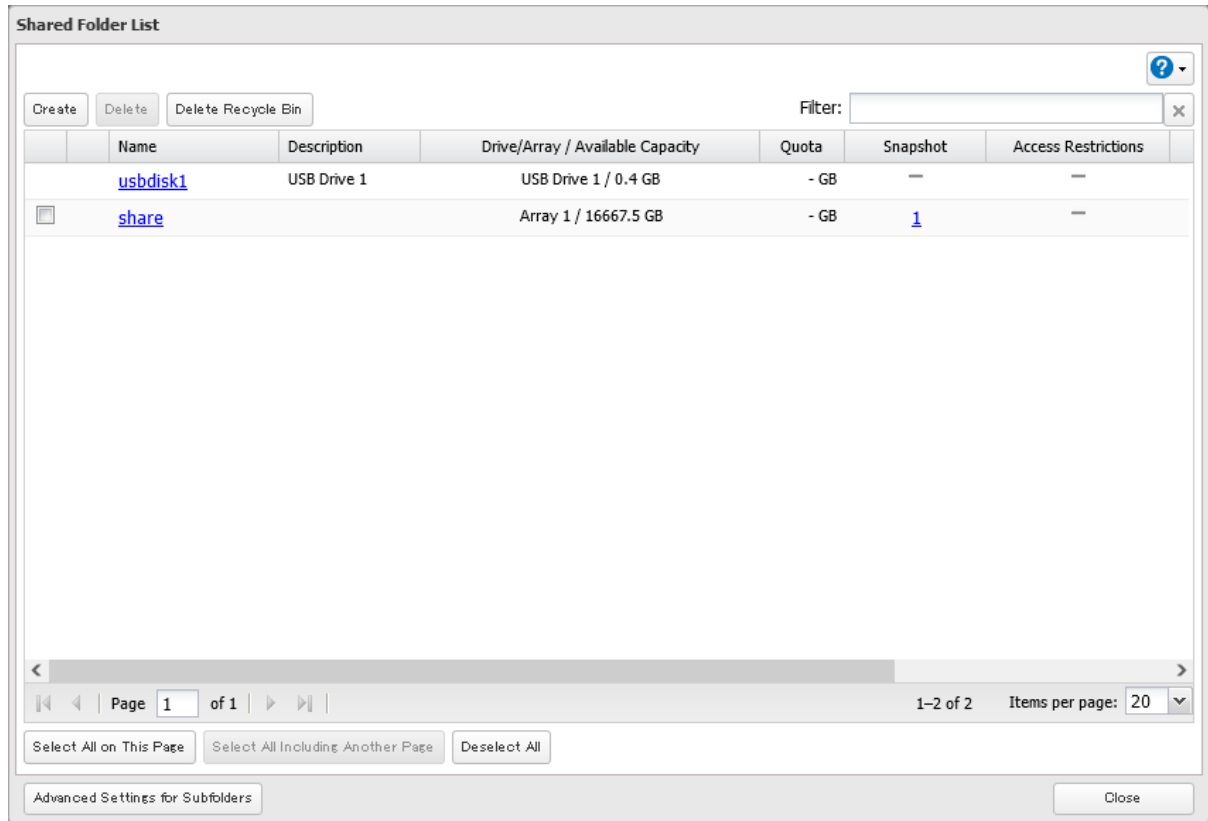

### 4 Choose either "Manual caching of documents", "Automatic caching of documents", or "Automatic caching of programs and documents" on the *Option 1* tab, then click OK.

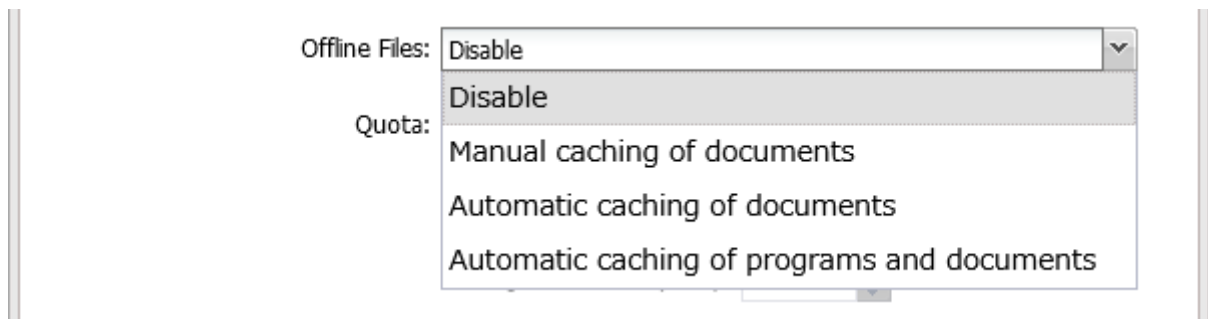



**Manual caching of documents:** User selects files that are cached.

**Automatic caching of documents:** Opened files can be cached locally for offline use. Previous versions of files that are not synchronized are automatically replaced by the latest versions.

**Automatic caching of programs and documents:** Opened files can be cached locally for use offline. Previous versions of files and applications executed on the network that are not synchronized are automatically replaced by the latest version of the files and applications.

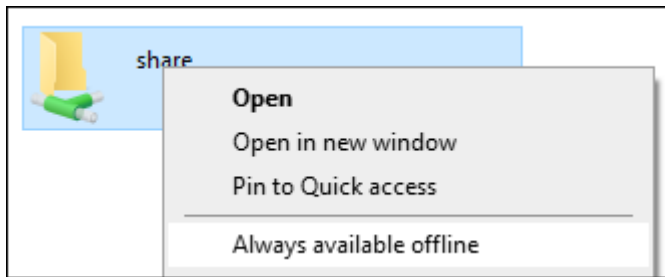
- 5** From File Explorer, right-click the icon of the shared folder on the TeraStation for which you have set the offline feature, then click *Always available offline*.



- 6** The process is complete when the shared folder icon is changed to .

When the configuration of offline settings and synchronization settings is finished, synchronization will begin. If the computer is disconnected from the network after synchronization is finished, the offline file function can be used. Offline files can be accessed by the original Universal Naming Convention (UNC) where the data was saved.

**Notes:**

- If you cannot access offline files, try the following procedure:
  - (1) Reconnect the computer to the network.
  - (2) From Control Panel, change the view to the icon view and click *Sync Center*. Click *Sync All* to synchronize all offline files.
  - (3) Disconnect the computer from the network and verify that you can access offline files.
- If you have configured the recycle bin for the shared folder, temp files may be created in the recycle bin.

# Chapter 4 RAID Modes and Drive Management

---

## Available RAID Modes

---

The TeraStation supports multiple types of RAID. The type of RAID arrays available for use depends on how many drives are installed on your TeraStation.

### Notes:

- If you change the RAID mode, all data on the array is deleted. This is true for every procedure in this chapter. Always back up any important data before performing actions that affect your RAID array.
- Some arrays will allow you to change the RAID mode without losing data by adding drives. To change a RAID mode by adding drives to the existing array, refer to the [“Managing a RAID Array Without Deleting Data”](#) section below.
- Drive capacity is displayed in Settings in actual gigabytes. The Properties window in Windows may show GiB instead, which will be a smaller number.
- If the TeraStation is restarted or shut down while changing the RAID mode, the message will change from I46 or I47 to I18.
- RAID 5, 6, and 10 are only available for TeraStation models that allow three or more drives to be inserted. Please check Settings on your model before changing the RAID mode.

### JBOD

This mode treats the drives inside the TeraStation as individual drives. The usable space is equal to the total capacity of all drives on the TeraStation. If any of the drives fail, then all data on that drive will be lost.

### RAID 6

A RAID 6 array is available for TeraStations with four or more drives. RAID 6 combines four or more drives into a single array. The usable space is equal to the sum of the capacity of all drives minus the capacity of two drives. For example, if four drives are combined into a RAID 6 array, the usable space is the sum of the capacity of two drives. If up to two drives in the array fail, you can recover data by replacing any failed drives. If three or more drives fail, then all data in the array will be lost.

### RAID 5

A RAID 5 array is available for TeraStations with three or more drives. RAID 5 combines three or more drives into a single array. The usable space is equal to the sum of the capacity of the drives minus the capacity of one drive. For example, if four drives are combined into a RAID 5 array, the usable space is the sum of three drives. If one drive in the array fails, you can recover data by replacing the failed drive. If two or more drives fail at the same time, then all data in the array will be lost.

### RAID 1

A RAID 1 array combines two or more drives into a mirrored array. The usable space is equal to the capacity of a single drive. Identical data is written to each drive. If a drive fails, data can be recovered by replacing the failed drive. As long as one drive in the array remains undamaged, all data in the array can be recovered.

## RAID 0

A RAID 0 array combines two or more drives into a single array. The usable space is equal to the total capacity of all drives in the array. This simple RAID mode offers faster performance than RAID modes that include parity. If a single drive in the array fails, then all data in the array will be lost.

## RAID 10

A RAID 10 array is available for TeraStations with four or more drives. In this mode, mirrored pairs of drives in RAID 1 arrays are combined into a RAID 0 array. The usable space is equal to the capacity of the smallest drive multiplied by the number of drives divided by two.

The default RAID mode is RAID 6.

# Working with RAID Arrays

## Using JBOD

With JBOD, each drive on the TeraStation is addressed separately. To put drives in an array into JBOD, follow the procedure below.

- 1 From Settings, click *Storage*.



- 2 Click the settings icon (  ) to the right of "RAID".



- 3 Click the array to delete.

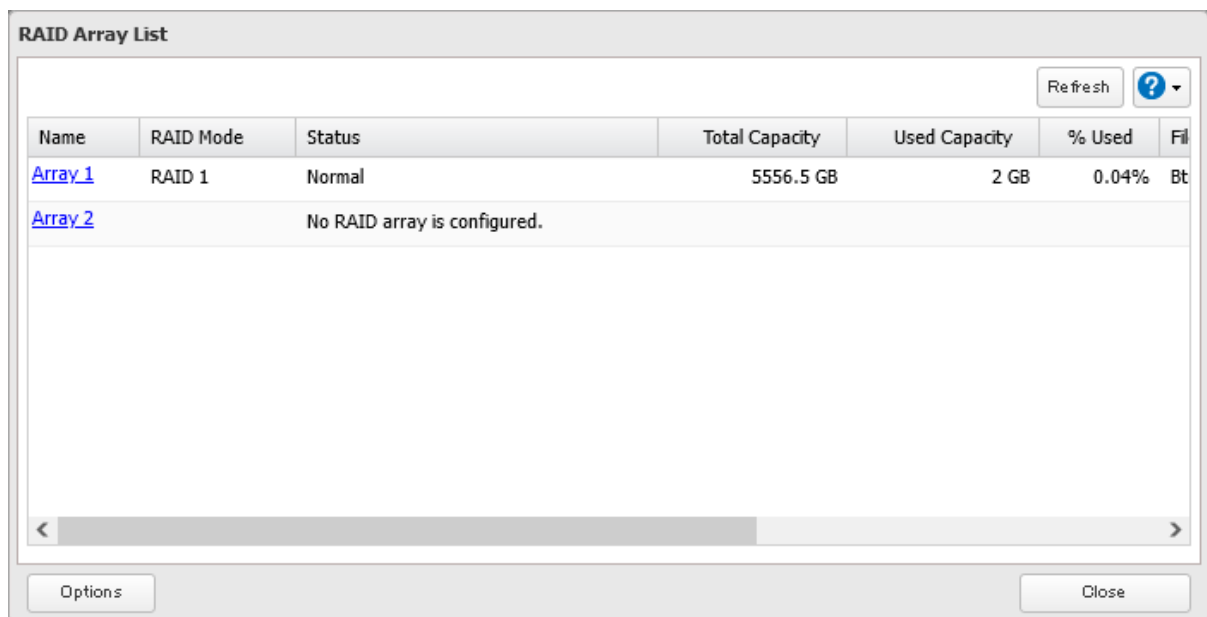

**4** Click *Delete RAID Array*.

Array 1

Current RAID Mode: RAID 1

New RAID Mode: RAID 1

Change at least one setting.

Select the drive to add to a RAID array.

Drive	Status	Model Name	Shared Folder	Capacity	Hot Spare
<input checked="" type="checkbox"/> Drive 1	Array 1 / Normal	WDC WD60EFZX-68B	-	5556.6 GB	-
<input checked="" type="checkbox"/> Drive 2	Array 1 / Normal	WDC WD60EFZX-68B	-	5556.6 GB	-
<input type="checkbox"/> Drive 3	Normal	WDC WD60EFZX-68B	-	5556.5 GB	<a href="#">Set as a hot spare</a>
<input type="checkbox"/> Drive 4	Normal	WDC WD60EFZX-68B	-	5556.5 GB	<a href="#">Set as a hot spare</a>

Select All Deselect All

Delete RAID Array Change RAID Array Cancel

**5** The “Confirm Operation” screen will open. Enter the confirmation number, then click *OK*.

**6** The process is complete once you close the confirmation window that appears.

When the drives are put into JBOD, next create a shared folder by referring to the [“Adding a Shared Folder”](#) section in chapter 3.

## Creating a RAID Array

---

Before creating a new RAID array, first put the drives into JBOD by referring to the [“Using JBOD”](#) section above. Then, follow the procedure below.

**1** From Settings, click *Storage*.



**2** Click the settings icon (  ) to the right of “RAID”.

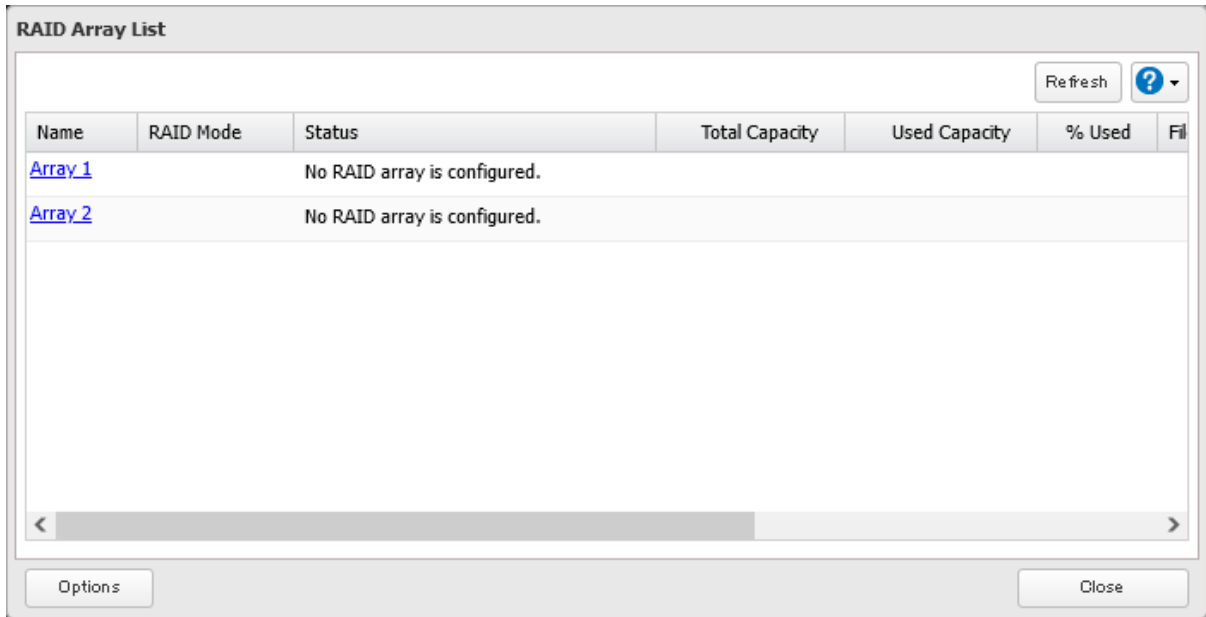
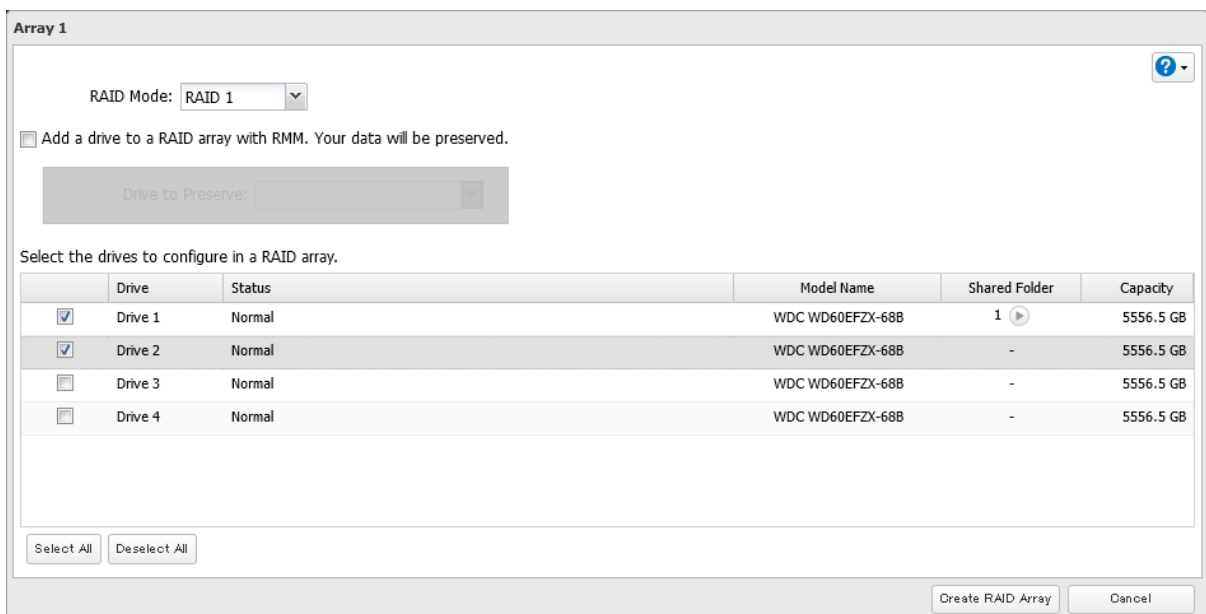

**3** Choose a RAID array.**4** Select a RAID mode and the drives to be used, then click *Create RAID Array*.

**5** Depending on the RAID configuration, the message will appear. Read the message carefully and click Yes to proceed.

**6** The “Confirm Operation” screen will open. Enter the confirmation number, then click OK.

**7** The process is complete once you close the confirmation window that appears.

When the RAID array has been created, next create a shared folder by referring to the [“Adding a Shared Folder”](#) section in chapter 3.

## **Shutting Down the TeraStation Automatically If an Error Occurs**

This function will shut down the TeraStation automatically if an error occurs on a drive that is used in a redundant RAID array.

For the TS51220RH TeraStation model users, also enabling email notifications is recommended if auto shutdown is enabled. LEDs on the TeraStation will extinguish when it shuts down so the failed drive will not be identified. In such a case, you can confirm the failed drive number in the notification email. To configure email notifications, refer to the [“Email Notification”](#) section in chapter 10.

To configure auto shutdown, follow the procedure below.

- 1 From Settings, click *Storage*.



- 2 Click the settings icon (  ) to the right of "RAID".

 RAID



- 3 Click *Options*.

**RAID Array List**



Name	RAID Mode	Status	Total Capacity	Used Capacity	% Used	Fil
<a href="#">Array 1</a>	RAID 1	Normal	5556.5 GB	2 GB	0.04%	Bt
<a href="#">Array 2</a>	No RAID array is configured.					

- 4 Click *Edit*.

**5** Change the “Error Behavior” option to “Shut down” and click *OK*.

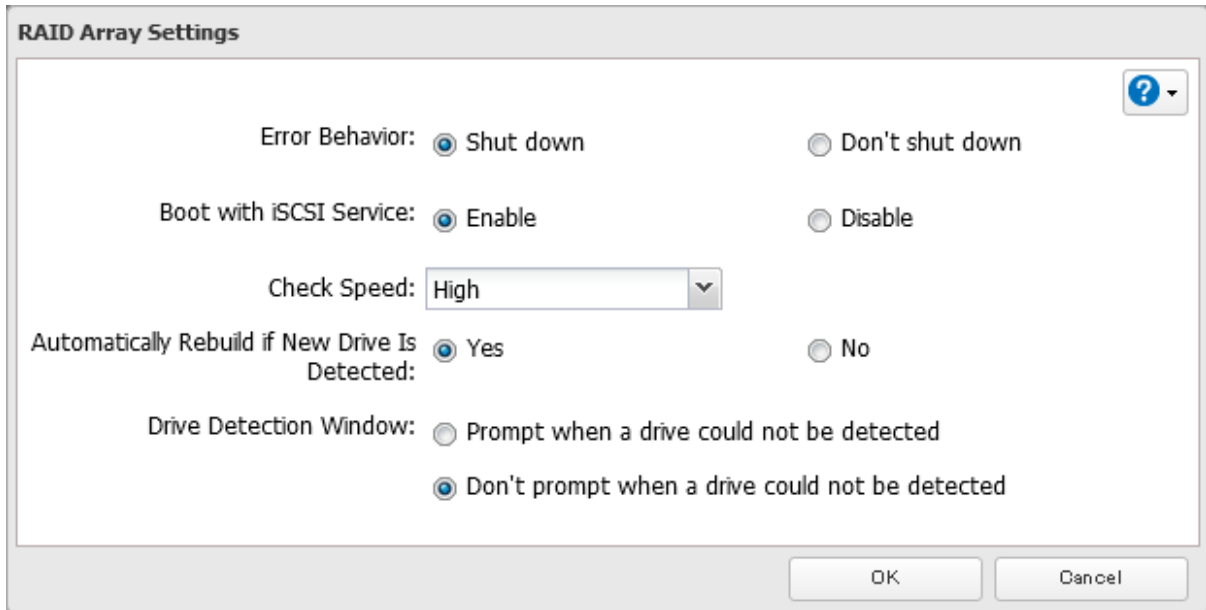

**6** The process is complete once you close the confirmation window that appears.

## Rebuilding the RAID Array Automatically for the TS51220RH

If auto RAID rebuild is enabled, RAID arrays will rebuild automatically after a failed drive is replaced. You may enable or disable auto RAID rebuild by following the procedure below.

**Note:** This function is only for the TS51220RH TeraStation model. Other models will not display this function in Settings.

**1** From Settings, click *Storage*.



**2** Click the settings icon (  ) to the right of “RAID”.



**3** Click *Options*.

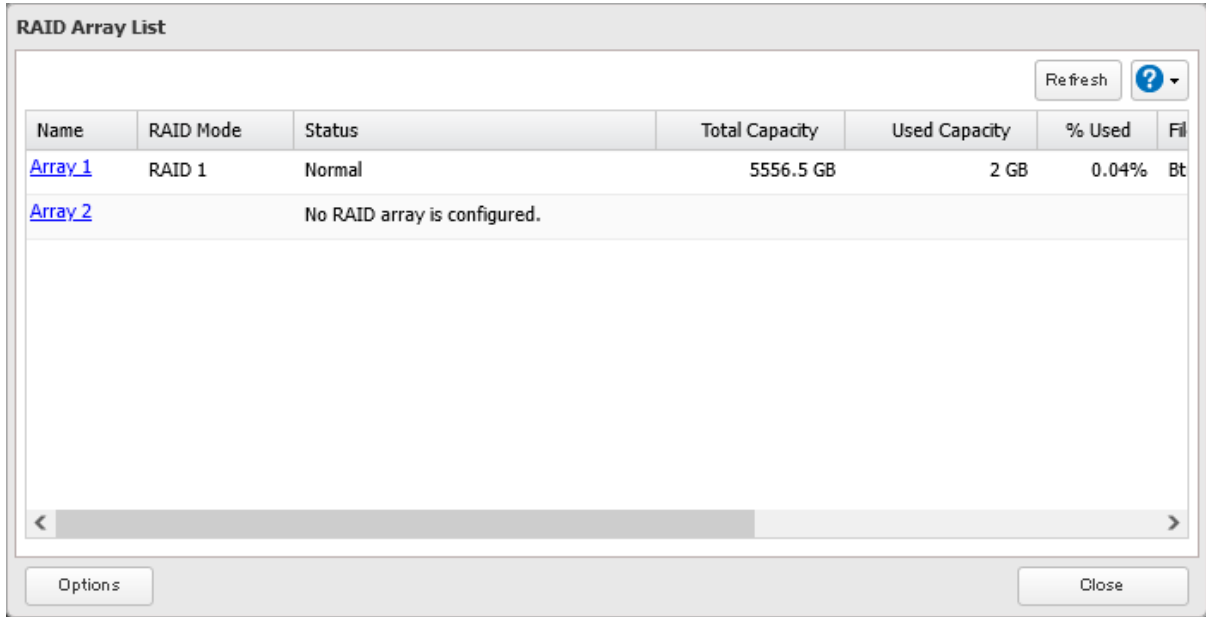

**4** Click *Edit*.

**5** Change the “Automatically Rebuild if New Drive Is Detected” option to “Yes” and click *OK*.

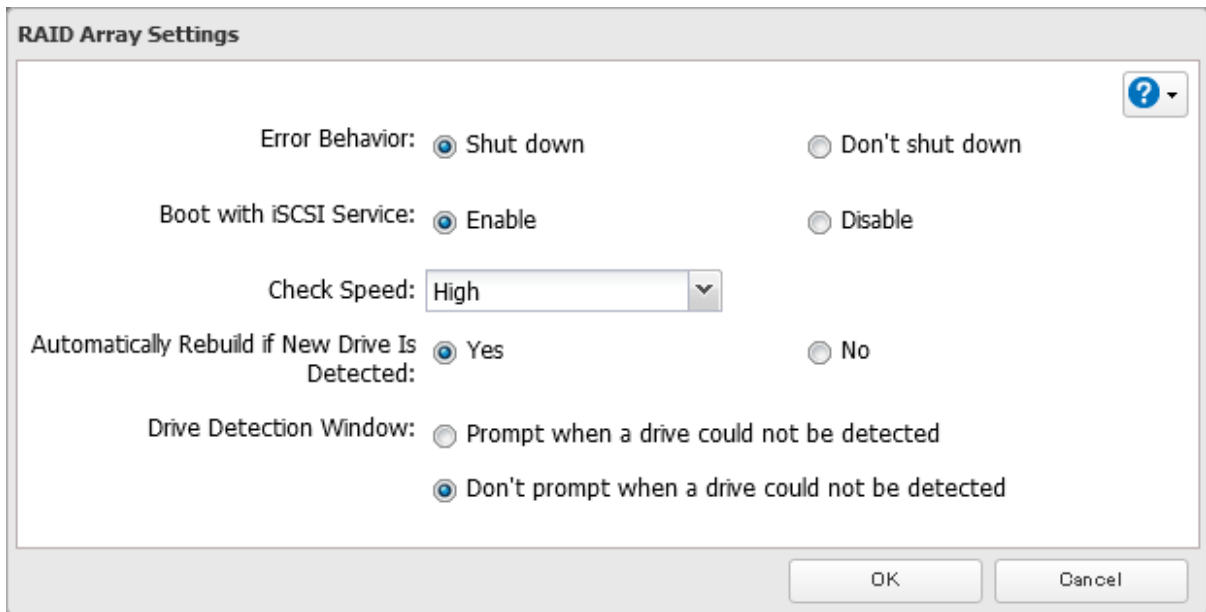

**6** Read the message carefully and select the checkbox, then click *OK*.

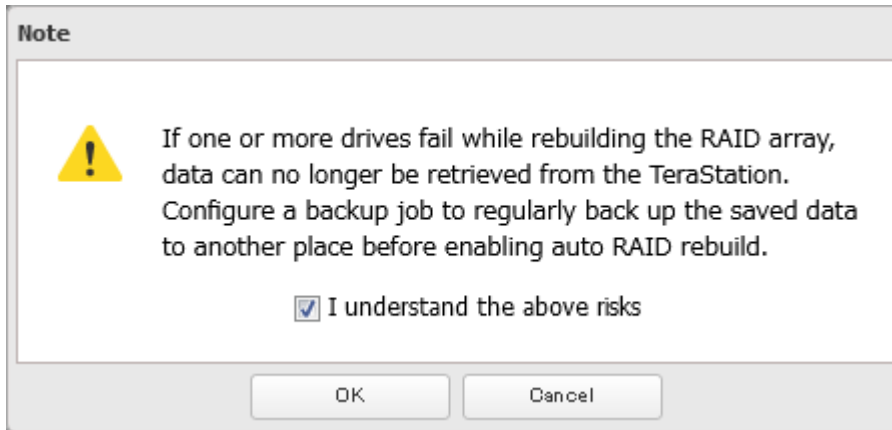

**7** The process is complete once you close the confirmation window that appears.

## Configuring Actions for If a Drive Used for the RAID Array Has Not Been Detected

---

You can configure actions to be taken by the TeraStation if a drive used for the RAID array cannot be mounted when booting.

### Hiding the Confirmation Screen

Configure to display or hide the confirmation screen that showcases the actions for if a drive used for the RAID array cannot be mounted when booting. The confirmation screen is configured to appear by default. To hide the screen, follow the procedure below.

**1** From Settings, click *Storage*.



**2** Click the settings icon (  ) to the right of "RAID".

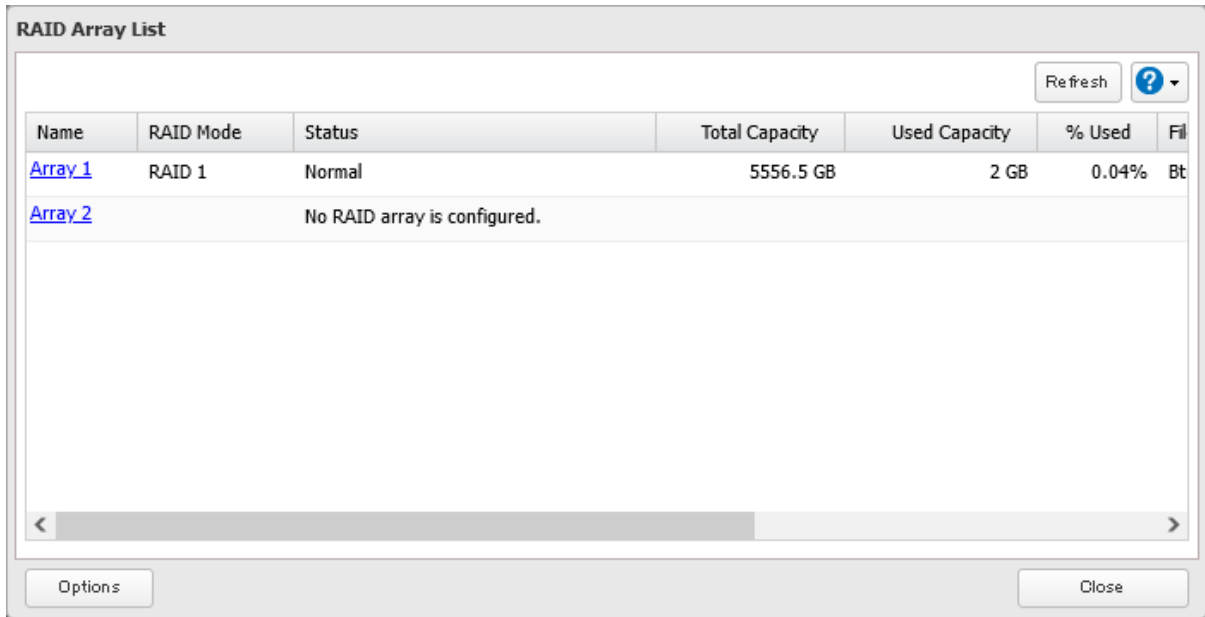
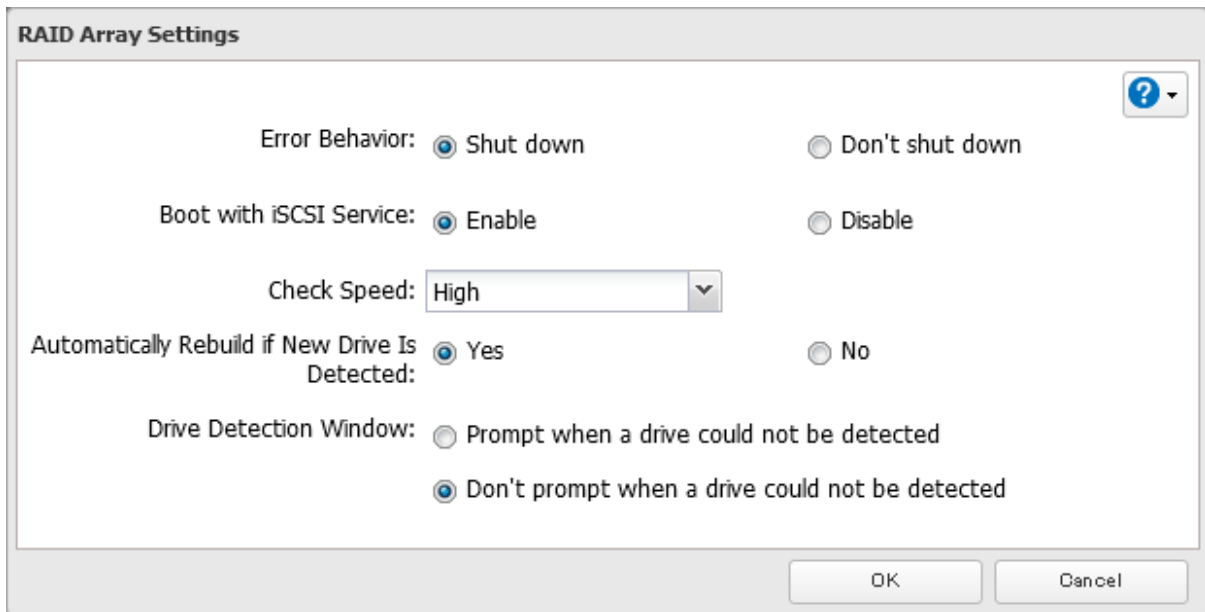

**3** Click *Options*.**4** Click *Edit*.**5** Change the “Drive Detection Window” option to “Don't prompt when a drive could not be detected” and click *OK*.**6** The process is complete once you close the confirmation window that appears.

If the confirmation screen is not set to appear, an undetected drive will automatically be dismounted from the TeraStation. Subsequently, the TeraStation will enter degraded mode if a redundant RAID mode has been configured and the RAID array will be corrupted if RAID 0 has been configured, resulting in data loss. It is recommended to proceed without changing settings that would prevent the confirmation screen from appearing.

### Selecting the Action on the Confirmation Screen

When the confirmation screen is displayed, the following screen will appear after logging in to Settings if the drive used for the RAID array could not be mounted. Select the action to run when the screen appears.

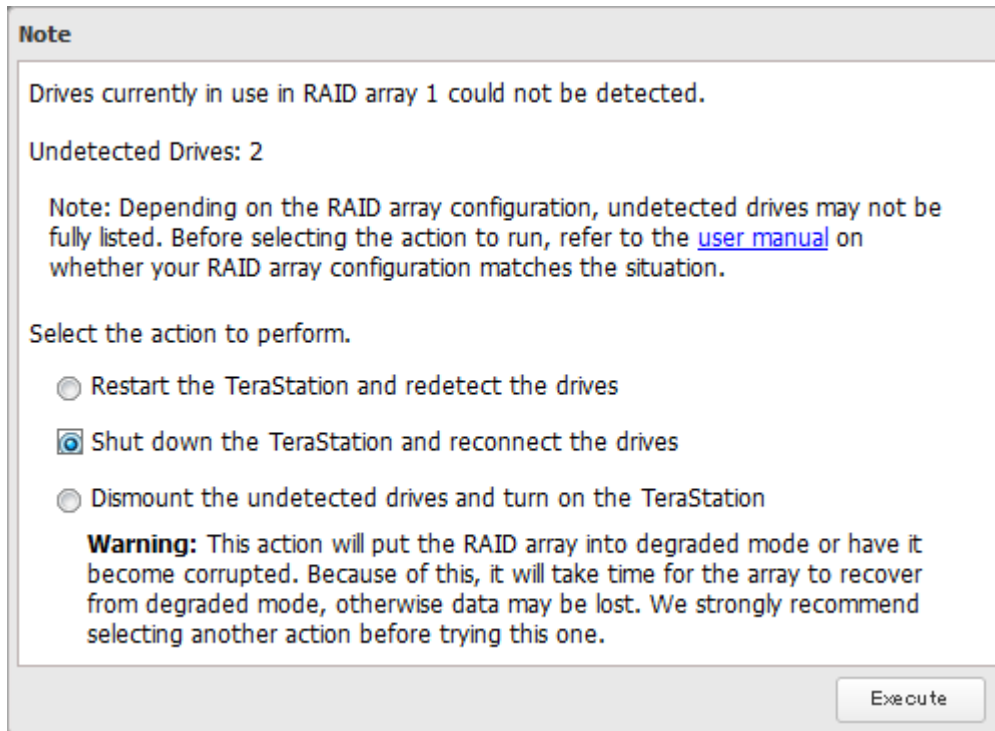

## Conditions and Corrective Actions If Undetected Drives Aren't Displayed Properly

Even when you configure the NAS to show the confirmation screen if a drive being used for the RAID array cannot be mounted, undetected drives will not be displayed under the following conditions. If you are using any of the RAID array configurations below, follow the corrective procedure.

Conditions	Corrective Actions
RAID 10 has been configured.	<ol style="list-style-type: none"> <li>1 Refer to the <a href="#">“Selecting the Action on the Confirmation Screen”</a> subsection above on how to access the confirmation screen.</li> <li>2 Select “Shut down the TeraStation and reconnect the drives” and click <i>Execute</i>.</li> <li>3 After the TeraStation shuts down, confirm that all drives have been inserted properly.</li> <li>4 Press the power button to power on the TeraStation.</li> <li>5 Log in to Settings and make sure the confirmation screen doesn't appear.</li> </ol>
Multiple arrays have been configured.	

## Configuring a Hot Spare

If you have a hot spare configured and an array fails, the TeraStation immediately switches over to the hot spare. To use a hot spare, you need a RAID 1 or RAID 5 array and an extra drive that's not part of an array.

### Notes:

- All data on the hot spare drive is deleted when it is configured as a hot spare and again when it changes from a spare to a drive in the array.
- The hot spare drive will be used for all RAID arrays, no matter which RAID array configurations are implemented. If multiple RAID arrays are configured and one of the drive fails, the malfunctioning drive will automatically be replaced to the hot spare.

For example, there are two arrays with RAID configured and the first array is selected to configure the hot spare in the following procedure, the hot spare can also be used by another array if a drive on the second RAID array fails.

**1** From Settings, click *Storage*.



**2** Click the settings icon (  ) to the right of "RAID".

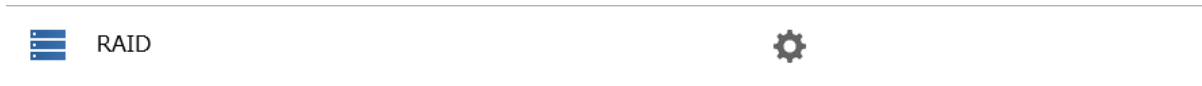

**3** Choose a RAID array.

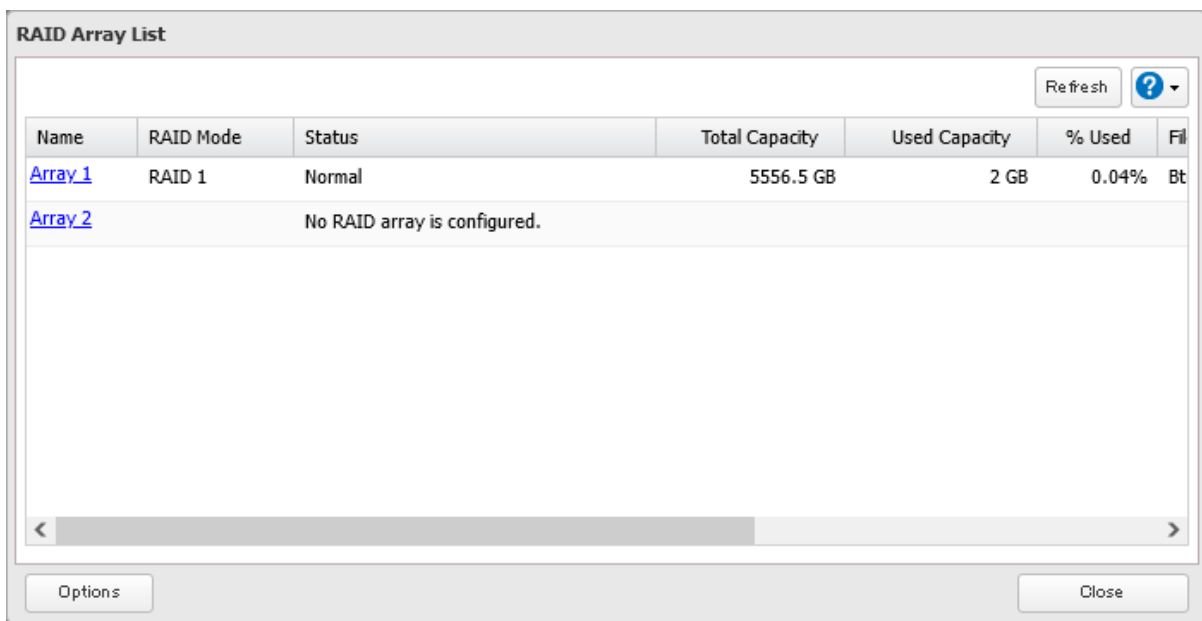

**4** Click *Set as a hot spare*.

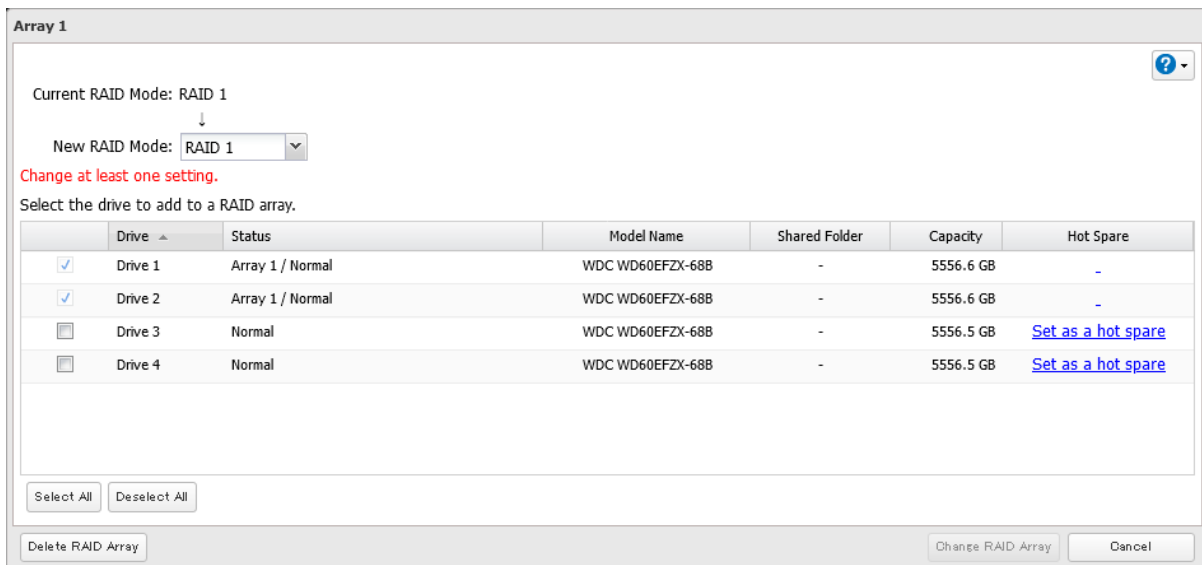

- 5** Read the message carefully and select the checkbox, then click *OK*.

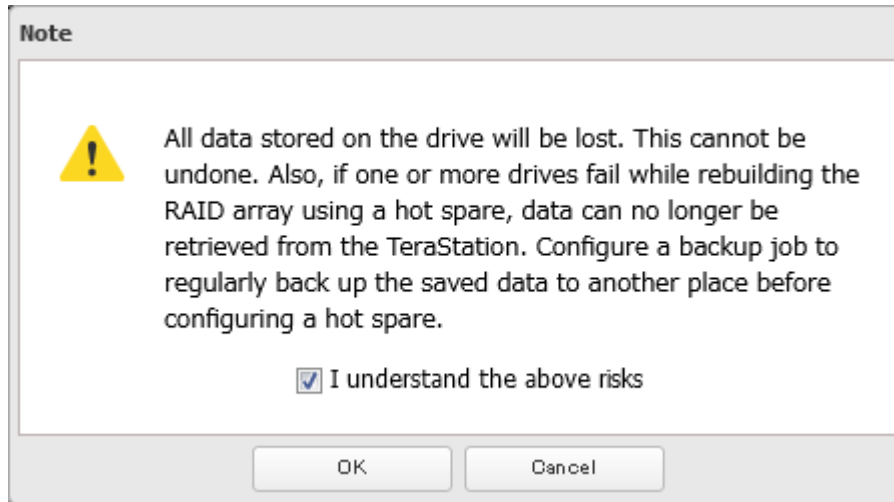

- 6** The “Confirm Operation” screen will open. Enter the confirmation number, then click *OK*.

- 7** The process is complete once you close the confirmation window that appears.

**Note:** To turn the hot spare back to a normal drive, choose *Set as a normal drive*.

## Managing a RAID Array Without Deleting Data

You can manage a RAID array without erasing data on the drives by using RMM (RAID Mode Manager). The following chart explains the transition status of drives after using RMM. The “n” in the chart below refers to the number of drives that make up the RAID array.

Current Drive Status	New RAID Mode	Capacity	Redundancy (Drive Failure Resistance)
JBOD	RAID 1	No increase	Improve (1 drive)
RAID 1	RAID 1	No increase	Improve ( $n - 1$ drives)
	RAID 5	Increase	No change (1 drive)
RAID 5	RAID 5	Increase	No change (1 drive)
	RAID 6	No increase	Improve (2 drives)
RAID 6	RAID 6	Increase	No change (2 drives)

**Note:** RMM can be used to expand an array by only one drive per operation. To expand by two or more drives, RMM must be activated multiple times. For example, if you want to create a RAID 6 array by adding two drives, change the RAID mode to RAID 5 first using one drive, then change it to RAID 6 using another drive.

If using a TeraStation model that currently has unoccupied drive slots, such as in the case of partially-populated models, follow the procedure below to add new drives first. Otherwise, refer to the procedures in this section to configure the RAID array. The following examples use the case of the TS5420DN TeraStation model.

### Adding a Drive

The procedure for adding a new drive will vary depending on your device.

- 1** Open the front cover with the included key.
- 2** Push the drive’s unlock button for the empty slot and swing the lock mechanism out.
- 3** Pull out the drive cartridge and remove it from the TeraStation.

- 4 Insert the new drive (sold separately) into the empty slot with the lock mechanism remaining open and swing the lock back down until it clicks into place.
- 5 Close the front cover.
- 6 When the drive is recognized, the status LED will flash red and the I32 message will appear as a notification.
- 7 From Settings, click *Storage*.



- 8 Click the settings icon (  ) to the right of "Drives".



- 9 Select the inserted new drive and click *Format Drive*.

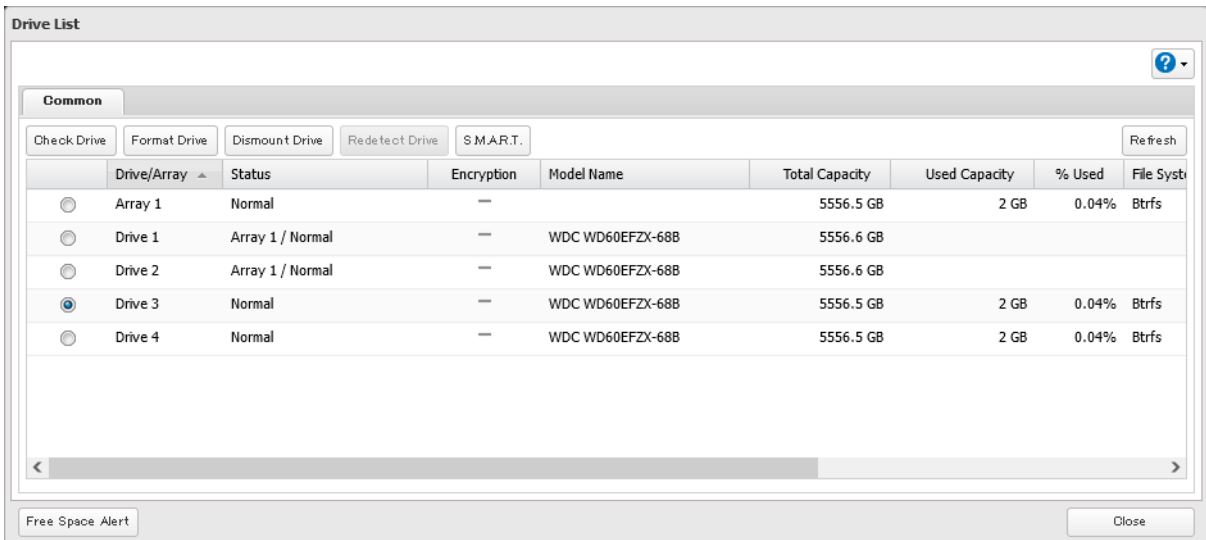

- 10 Select a format type and click *Format*.

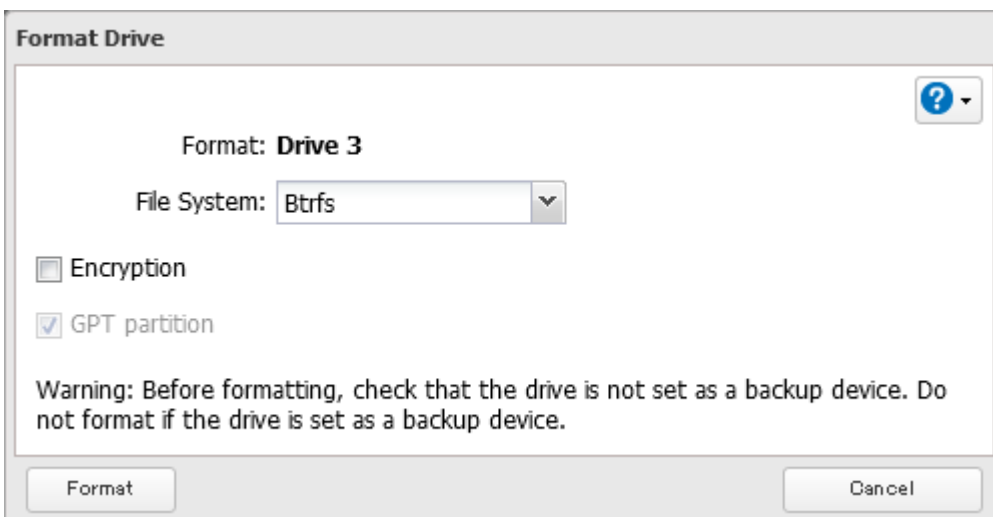

**11** The “Confirm Operation” screen will open. Enter the confirmation number, then click *OK*.

**12** The process is complete once you close the confirmation window that appears.

## Drives That Are Currently in JBOD

To use RMM for drives in JBOD, you must have at least two drives available in JBOD. Follow the procedure below.

**1** From Settings, click *Storage*.



**2** Click the settings icon (  ) to the right of “RAID”.



**3** Choose a RAID array.

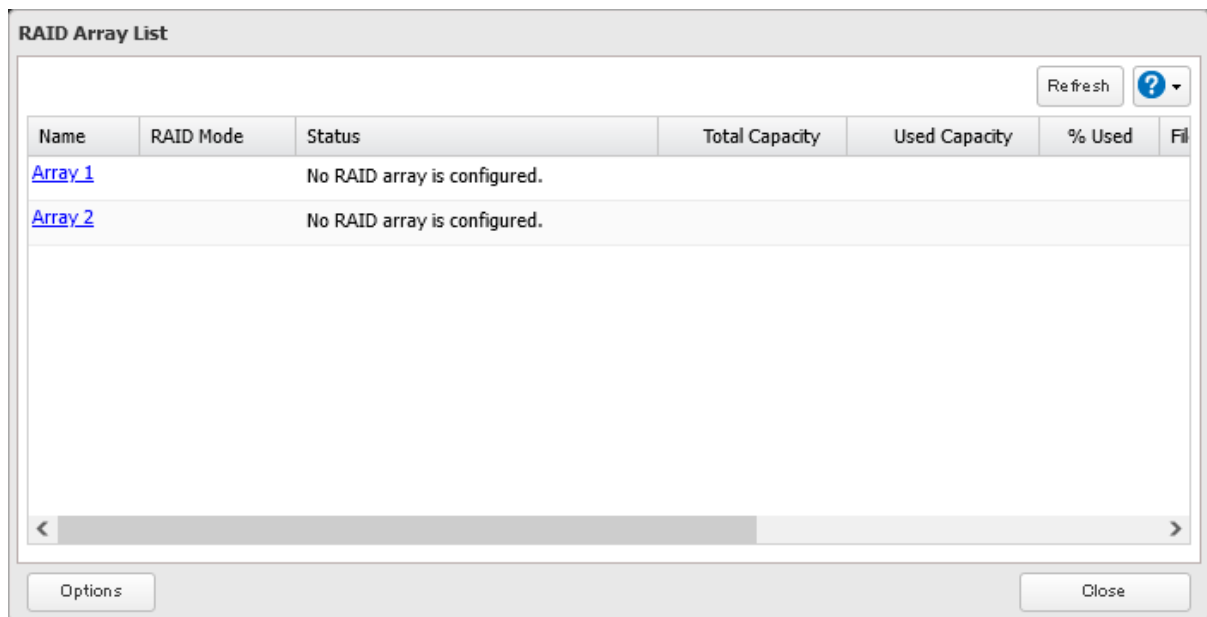

**4** Set the RAID mode to “RAID 1”.

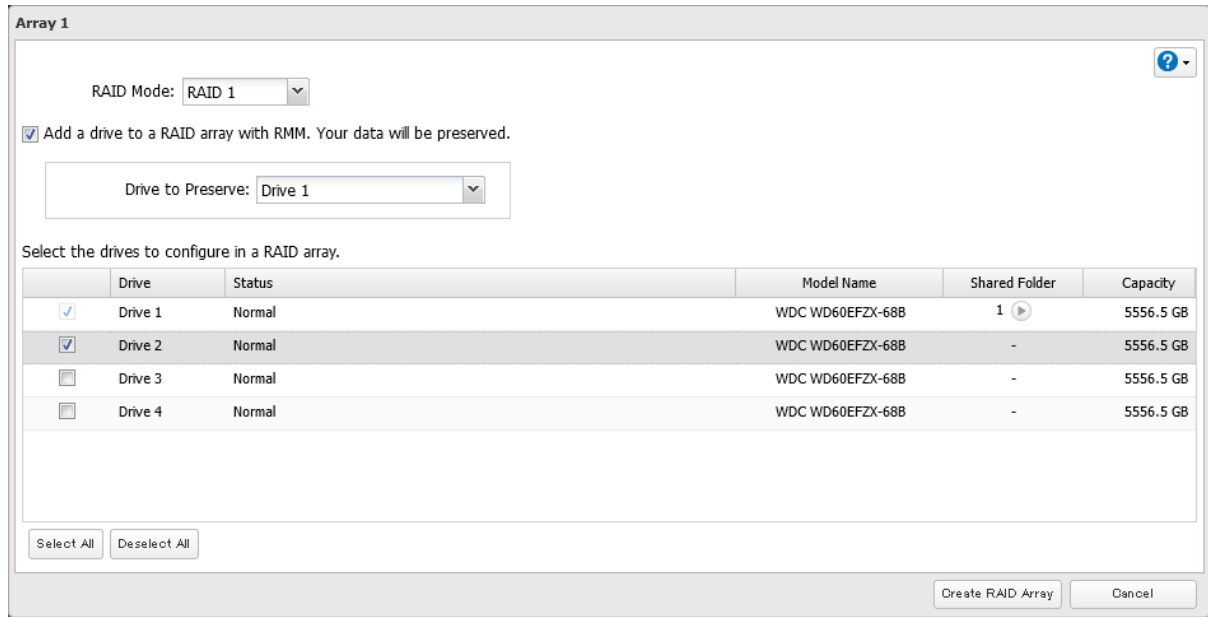

**5** Select the “Add a drive to a RAID array with RMM. Your data will be preserved.” checkbox.

**6** Select the drive whose data will be saved from the drop-down list.

**7** Select the drive to add to the RAID array.

**8** Click *Create RAID Array*.

**9** The “Confirm Operation” screen will open. Enter the confirmation number, then click *OK*.

**10** The process is complete once you close the confirmation window that appears.

**Drives That Are Currently in RAID 1, 5, or 6**

To use RMM for redundant RAID arrays (RAID 1, 5, or 6), you must have at least one drive available in JBOD. Follow the procedure below.

**1** From Settings, click *Storage*.



**2** Click the settings icon (  ) to the right of “RAID”.



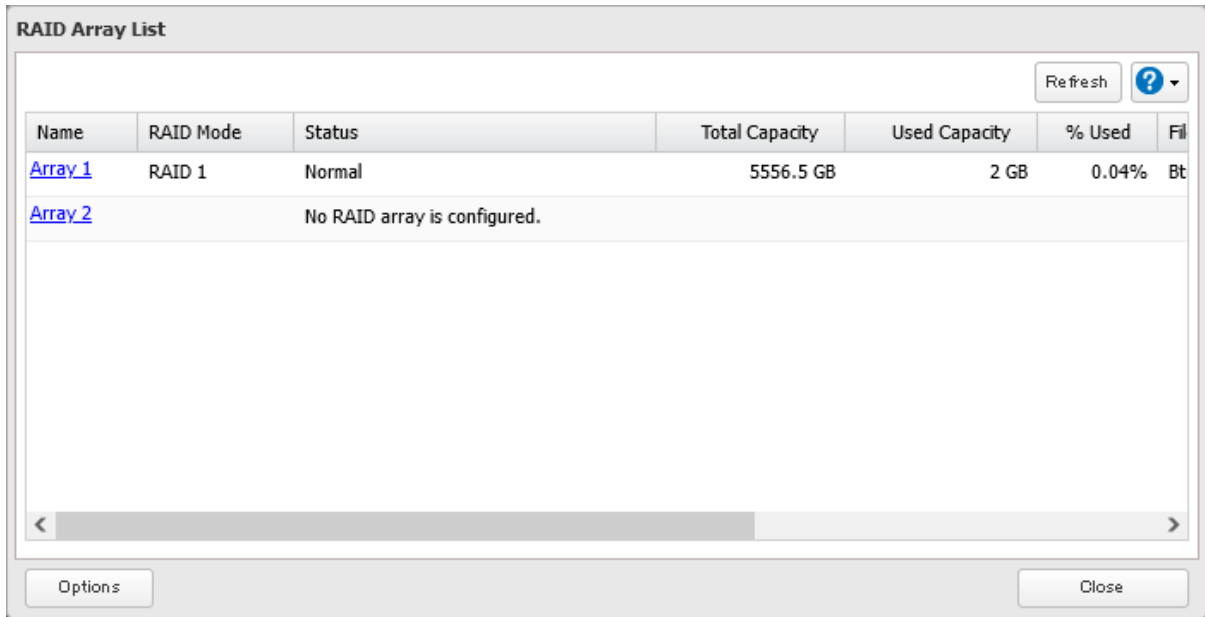
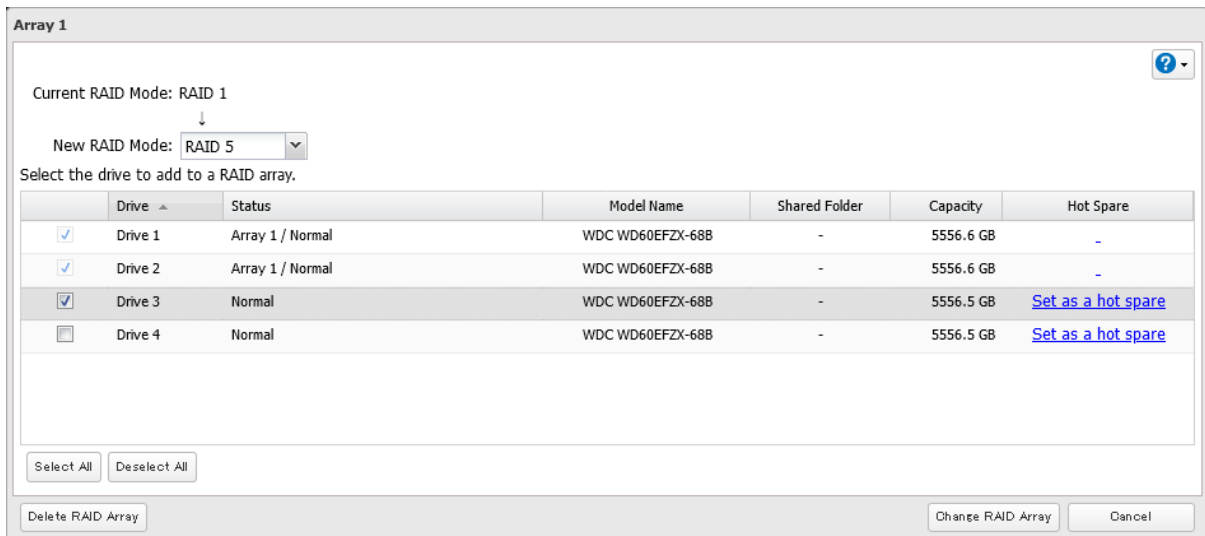

**3** Choose a RAID array.**4** Select one drive to add to the RAID array. If changing the RAID mode, choose the desired mode for the array from the drop-down list. Otherwise, keep the current RAID mode as is.**5** Click *Change RAID Array*.**6** The “Confirm Operation” screen will open. Enter the confirmation number, then click *OK*.**7** The process is complete once you close the confirmation window that appears.

## RAID Scanning

A RAID scan checks your RAID array for bad sectors and if it finds any, it automatically repairs them. Arrays other than RAID 0 are supported. For best results, run RAID scans regularly.

**1** From Settings, click *Storage*.

**2** Move the RAID scanning switch (  ) to the  position to enable RAID scanning.



**3** Click the settings icon (  ) to the right of "RAID Scanning".



**4** Click *Edit*.

**5** Select when to run the scan and click *OK*.

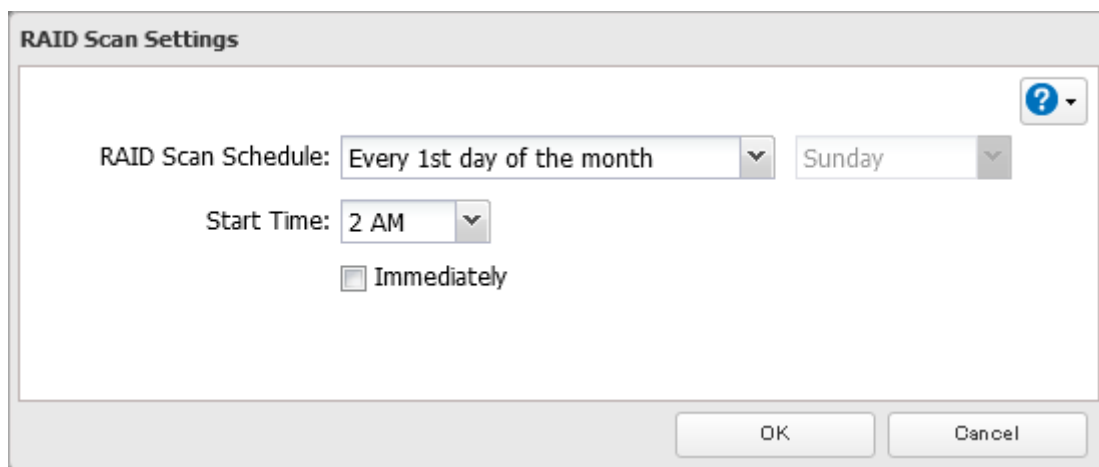

**6** The process is complete once you close the confirmation window that appears.

**Notes:**

- Select the "Immediately" checkbox to run a RAID scan immediately.
- To stop a RAID scan, click *Cancel RAID Scan*.

---

## Configuring Low Drive Space Alerts

---

You can configure the TeraStation to notify you when it is running low on free space, either by having a message displayed on the Dashboard in Settings or having the TeraStation send you an email notification. This function is applicable to internal drives, RAID arrays, and NAS volumes on the TeraStation.

**Note:** If you have configured low drive space alerts and created iSCSI volumes on the LVM-enabled area, the I65 message will appear as a notification.

**1** From Settings, click *Storage*.



2 Click the settings icon (  ) to the right of “Drives”.

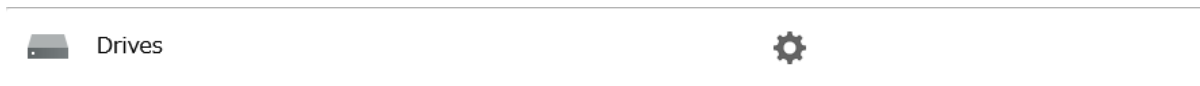

3 Click *Free Space Alert*.

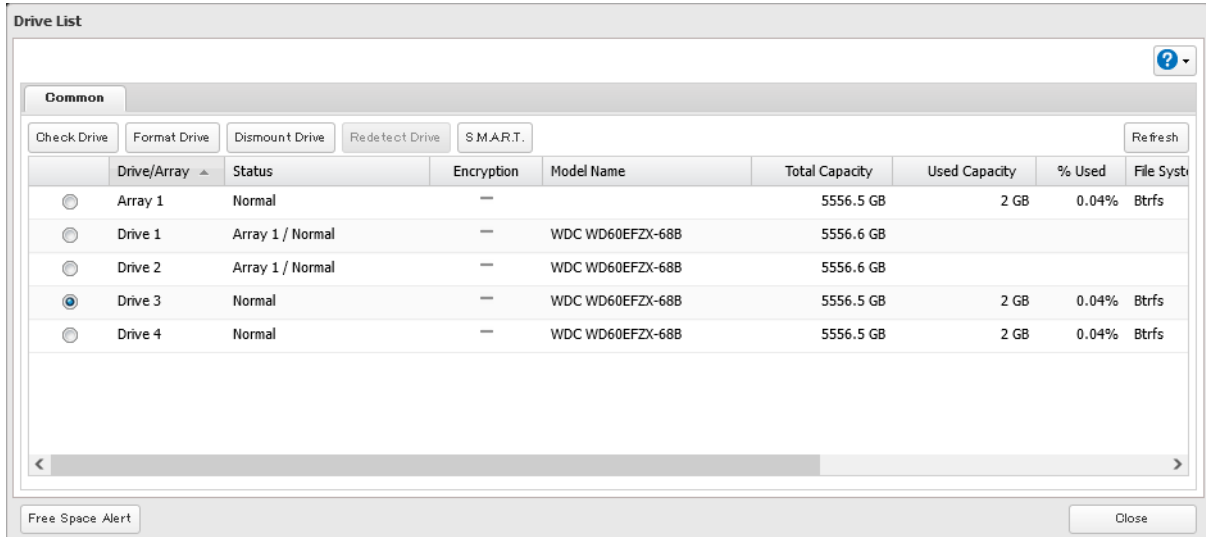

4 Enable “Free Space Alert” and enter the threshold value, then click *OK*.

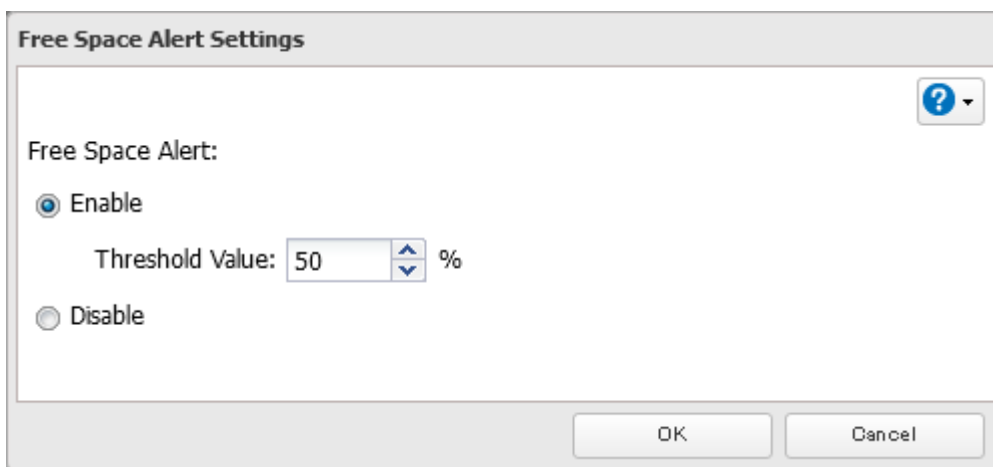

5 The process is complete once you close the confirmation window that appears.

The free space alert is now enabled. If the percentage of remaining free space on the TeraStation decreases past the threshold percentage, a notification will appear on the Dashboard in Settings. To configure free space alert email notifications, refer to the [“Email Notification”](#) section in chapter 10.

## Adding an External Drive

Your TeraStation features multiple USB ports, and you can connect an external drive to any of these ports except for the USB 2.0 port. Once connected, it appears as a shared folder on the TeraStation. A formatted drive is detected automatically. Unformatted drives should be formatted in Settings.

After a USB drive is recognized, the TeraStation adds “usbdisk x” to the shared folder list, where “x” is the USB port to which the drive is connected.

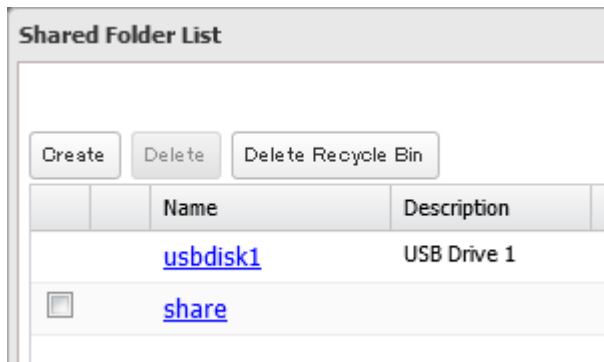

If a USB drive is unplugged without being dismounted first while the TeraStation is powered on, it may not be recognized properly when it is reconnected. If this occurs, restart the TeraStation and then reconnect the drive.

## Compatibility

Supported file systems for external USB drives are below:

File Systems	Recommended Situation
Btrfs	Connecting to this TeraStation.
XFS	Connecting to another Buffalo NAS device.
Ext3*1	Connecting to another Buffalo NAS device. XFS is recommended because the more files stored in one folder, the slower the performance. The available capacity will be less than the area formatted to XFS.
NTFS*2	Connecting to Windows computers. The NTFS-formatted drive can use many more functions of the operating system than an exFAT drive.
HFS Plus*2, 3, 4	Connecting to macOS computers. The HFS Plus-formatted drive can use many more functions of the operating system than an exFAT drive.
exFAT*1	Connecting to both Windows and macOS computers.
FAT32	Connecting to both Windows and macOS computers.

\*1 The available USB drive size is up to 16 TB.

\*2 This cannot be formatted from Settings.

\*3 This is read-only from the TeraStation. Files on the USB drive can be copied to the TeraStation.

\*4 This cannot be used if Apple Partition Map is used as the partition scheme when formatting.

Make sure only one device is connected to a USB port on the TeraStation. Note that only the first partition of a connected USB drive is mounted. Additional partitions are not recognized.

### Notes:

- If your USB 3.0 drive is not reconfigured after rebooting the TeraStation, unplug and reconnect it.
- When copying a file that is over 100 MB to a FAT32-formatted USB drive using File Explorer, an error message may appear. In such a case, use an FTP or SFTP connection to copy the file.
- When copying files from a shared folder to a FAT32-formatted USB drive, the progress bar may not be displayed or the file copying may fail. Using a file system other than FAT32 is recommended for the USB drive.
- After connecting an RDX drive to the TeraStation, click *Redetect Drive* anytime.

## Dismounting Drives

If the TeraStation is off, then all drives are already dismounted and may be unplugged safely. If the TeraStation is powered on, dismount drives (internal and external) before unplugging them by following the procedure below.

**Notes:**

- Do not dismount internal drives while a RAID array is rebuilding or RMM is being configured. If you do, data on the drives may be lost.
- To dismount an RDX cartridge from an RDX dock, first perform the dismount process either using the function button or from Settings, then press the eject button on the dock to disconnect the cartridge.
- While accessing files on a USB drive or if a USB drive has been set as a target folder for logs, the USB drive cannot be dismounted.
- If a USB drive is unplugged without being dismounted first while the TeraStation is powered on, it may not be recognized properly when it is reconnected. If this occurs, restart the TeraStation and then reconnect the drive.

## Using the Function Button

---

**Note:** If using the TS51220RH TeraStation model, dismount USB drives only from Settings.

When you press the function button, the TeraStation will beep once. Press and hold down the button until the TeraStation beeps again and the button starts blinking blue. It will take about six seconds. When the function button stops blinking and returns to glowing, the dismount is finished. You may now unplug any USB drives safely. After 60 seconds, the function button will go out and any drives that have not yet been unplugged will be remounted.

## Using Settings

---

**1** From Settings, click *Storage*.



**2** Click the settings icon (  ) to the right of "Drives" to dismount an internal drive or "USB Drives" to dismount an external drive.



- 3 Select the drive to dismount and click *Dismount Drive*.

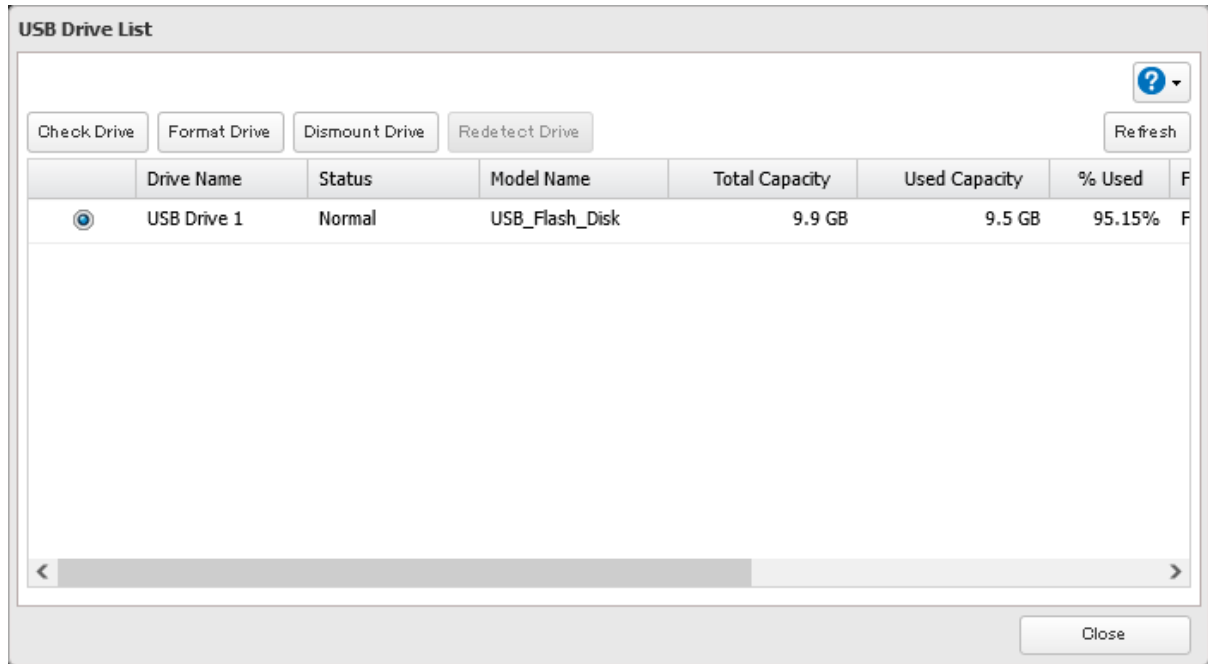

- 4 The "Confirm Operation" screen will open. Enter the confirmation number, then click *OK*.
- 5 The process is complete once you close the confirmation window that appears.

When the dismounting process is finished, it is safe to unplug the drive. Disconnect the drive from the TeraStation.  
**Note:** To remount the drive, unplug it and wait for approximately three minutes, then plug it back in.

## Checking Drives

A drive check tests the data on a drive on the TeraStation or one that is connected via USB for integrity. Detected errors are fixed automatically. With large drives, a drive check may run for many hours. Shared folders cannot be accessed during a drive check. Do not turn off the TeraStation until the drive check is finished. Follow the procedure below to run a drive check.

- 1 From Settings, click *Storage*.



- 2 Click the settings icon (  ) to the right of "Drives" to check an internal drive or "USB Drives" to check an external drive.



**3** Select the drive or array to test, then click *Check Drive*.

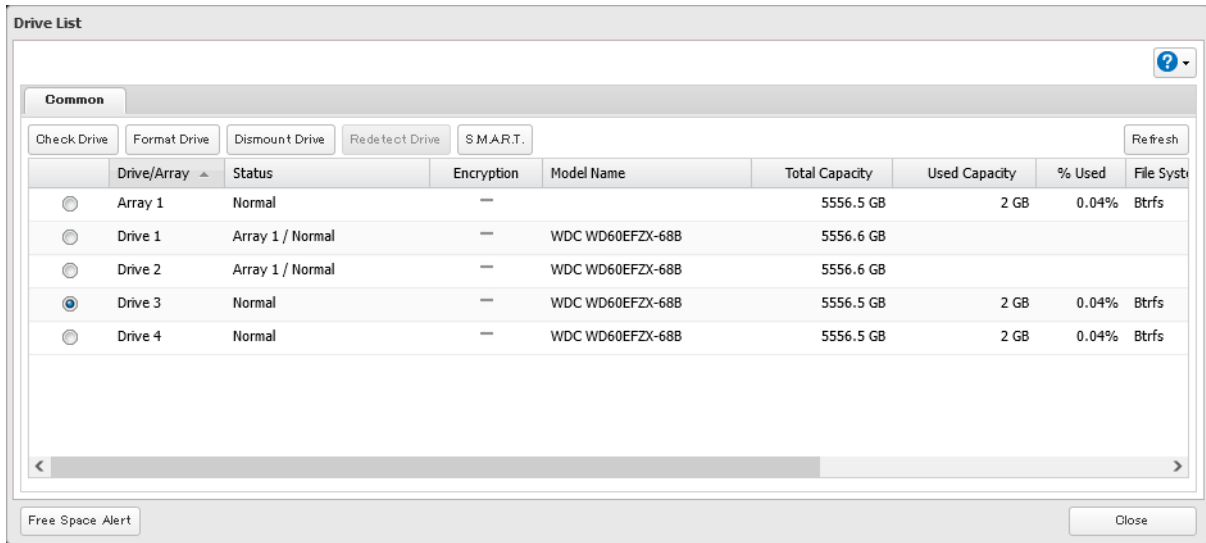

**4** Click *Check*. You have the option of deleting information files from macOS during the check if desired.

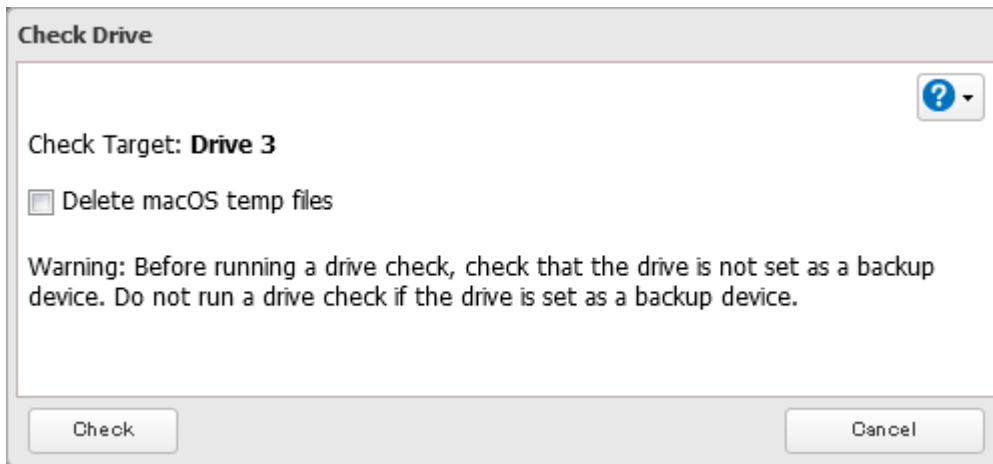

**5** Either the **I14** message for RAID arrays, the **I21** message for drives, or the **I27** message for USB drives will appear as a notification.

**6** The process is complete once you close the confirmation window that appears.

---

## S.M.A.R.T.

---

S.M.A.R.T. (Self-Monitoring, Analysis, and Reporting Technology) monitors internal drives to detect and report various indicators of reliability, in the hope of anticipating failures. If S.M.A.R.T. informs you of impending drive failure, you may choose to replace the drive to avoid outages and possible data loss. Follow the procedure below to check S.M.A.R.T. information for the TeraStation's internal drives.

**Note:** S.M.A.R.T. information is only available for internal drives.

## Displaying S.M.A.R.T. Information

**1** From Settings, click *Storage*.



**2** Click the settings icon (  ) to the right of "Drives".



**3** Select a drive to check and click *S.M.A.R.T.*

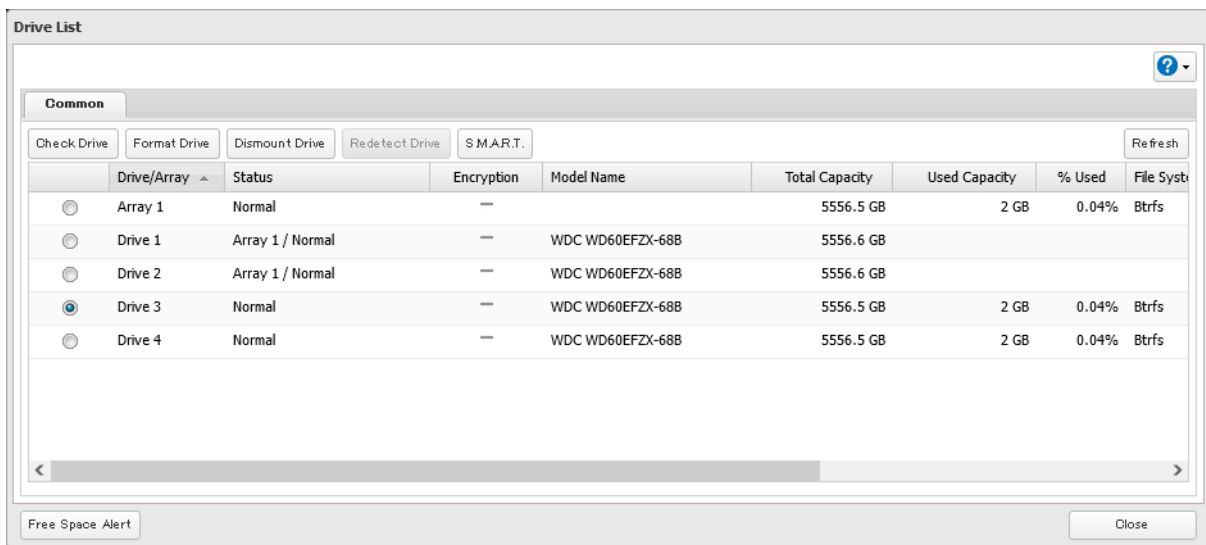

- 4** The process is complete when the S.M.A.R.T. information for the drive is displayed. Different information may be displayed depending on the brand of drives on your TeraStation. Critical attributes are displayed in bold.

S.M.A.R.T.

**Drive 1**

Model: WDC WD60EFZX-68B3FN0      Serial Number: WD-C816GYWG  
 Capacity: 6,001,175,126,016 bytes [6.00 TB]      Firmware Version: 81.00A81

Filter:

ID	Attribute	Status	Current Value	Worst Value	Threshold Value	Raw Value
1	Raw_Read_Error_Rate	OK	200	200	51	0
3	Spin_Up_Time	OK	248	190	21	4591
4	Start_Stop_Count	OK	100	100	0	513
5	<b>Reallocated_Sector_Ct</b>	OK	200	200	140	0
7	<b>Seek_Error_Rate</b>	OK	200	200	0	0
9	Power_On_Hours	OK	97	97	0	2254
10	<b>Spin_Retry_Count</b>	OK	100	100	0	0
11	Calibration_Retry_Count	OK	100	100	0	0
12	Power_Cycle_Count	OK	100	100	0	513
192	Power-Off_Retract_Count	OK	200	200	0	511
193	Load_Cycle_Count	OK	200	200	0	17

Close

## Checking the Drive Condition

Attributes with the worst value that is equal to or less than the threshold value may be significant. If an attribute reports a failure, or has had one in the past, it will be displayed in the status column. In such a case, replacing that drive is recommended.

## Formatting Drives

### Notes:

- Under some circumstances, data deleted when a drive is formatted can be recovered. To ensure that data is “gone forever”, a format might not be sufficient. Refer to the [“Erasing Data on the TeraStation Completely”](#) section below for more information.
- After a drive is formatted, the “% Used” and “Used Capacity” in Settings will not be 0. This is because some drive space is used for the system area.

- 1** From Settings, click *Storage*.



- Click the settings icon (  ) to the right of “Drives” to format an internal drive or “USB Drives” to format an external drive.



- Select the drive or array to format, then click *Format Drive*.

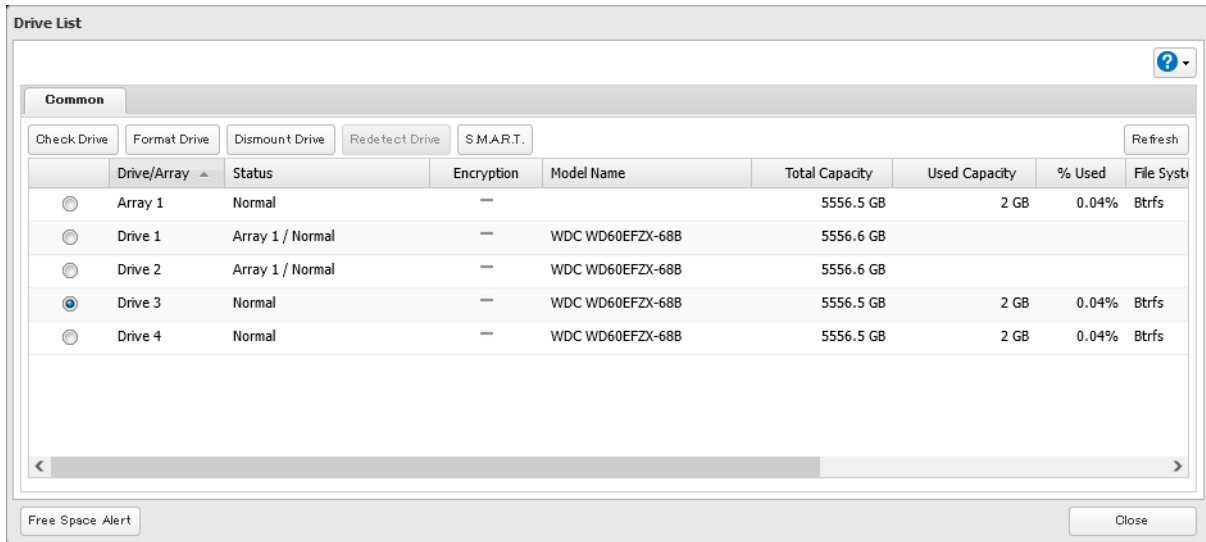

- Select a format type, then click *Format*.

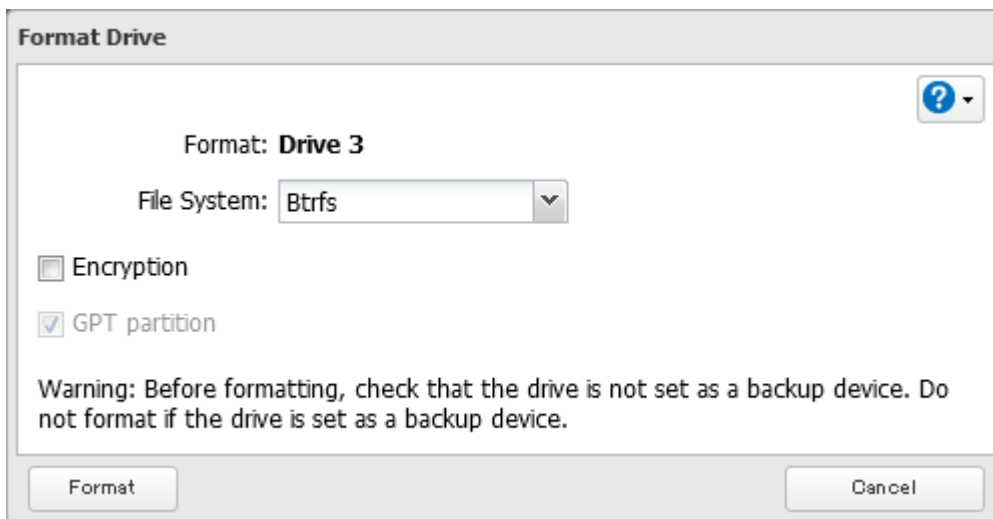

- The “Confirm Operation” screen will open. Enter the confirmation number, then click *OK*.
- Depending on the size and the formatted file system of your drive, the format may take several minutes or several hours to complete. Either the **I13** message for RAID arrays, the **I20** message for drives, or the **I28** message for USB drives will appear as a notification.
- The process is complete once you close the confirmation window that appears.

**Notes:**

- Do not turn off or disconnect power to the TeraStation while formatting a drive.
- For drives that are 2.2 TB or larger, make sure that the “GPT partition” checkbox is selected.

---

## Encrypting Drives

---

Internal drives (and arrays) can be encrypted with 256-bit AES during formatting. Encrypted drives and arrays are then readable only from that specific TeraStation. To decrypt a drive or array, clear the “Encryption” checkbox and format it again.

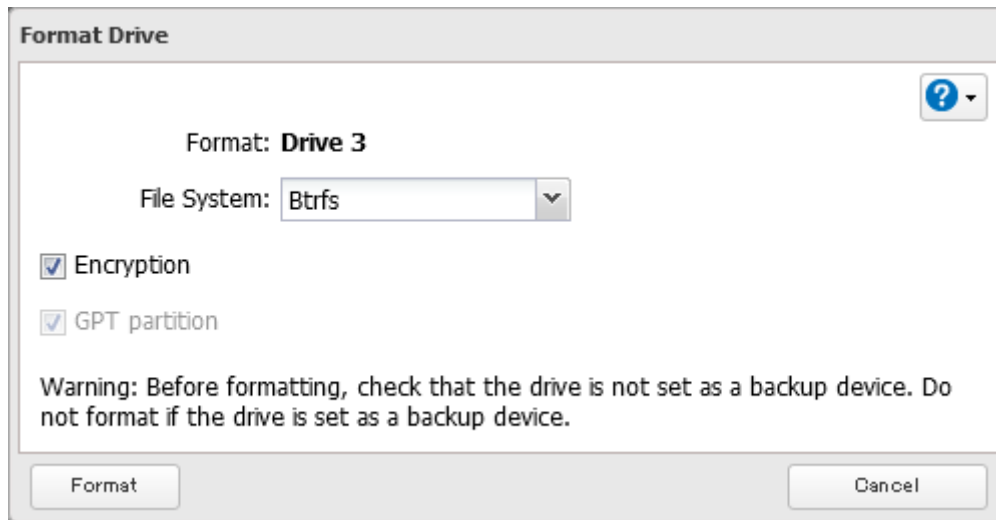

---

## Erasing Data on the TeraStation Completely

---

Under some circumstances, data from formatted drives can be recovered. The drive erasure process in this section does a much more thorough job of erasing data. This procedure is recommended for removing all data from a drive in a way that makes it nearly impossible to recover with current tools. The TeraStation will then be in the following state:

- All drives in JBOD
- An empty shared folder on each drive
- All settings returned to their default values
- All logs deleted

Follow the procedure below to completely and permanently erase all data from your TeraStation.

**1** From Settings, click *Management*.

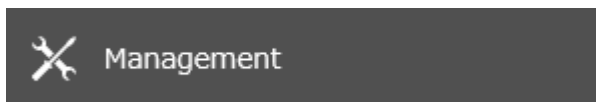

**2** Click the settings icon (  ) to the right of “Restore/Eraser”.



**3** Click *Erase TeraStation*.

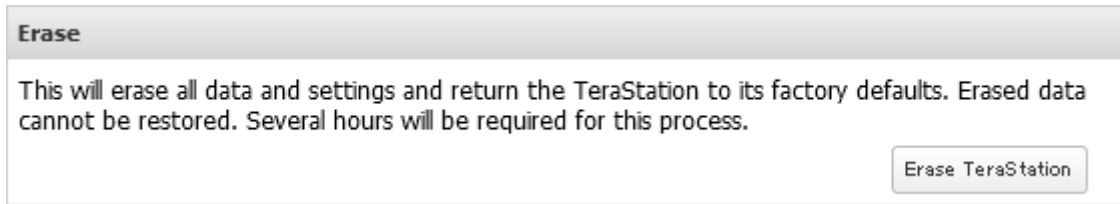

**4** The “Confirm Operation” screen will open. Enter the confirmation number, then click *OK*.

**5** The complete format process will begin. The process is complete when the TeraStation shuts down automatically. To power on the TeraStation, press the power button.

**Note:** If you remove a drive and then erase all data on the TeraStation, the E22 error along with the number of the removed drive will appear as a notification. You can still use the TeraStation.

---

## Quotas

---

### Limits for Shared Folders

---

You can set a quota for each shared folder, as well as a threshold alert where you will receive an email notification if the space used exceeds the configured threshold. To configure email notifications for the quota, refer to the [“Email Notification”](#) section in chapter 10.

**Notes:**

- When using quotas, disable the recycle bin or empty the trash folder often. The limited space includes the space used for trash.
- Quotas cannot be set for external drives connected to the TeraStation.

Follow this procedure to limit the shared folder space available for a user.

**1** From Settings, click *File Sharing*.



**2** Click the settings icon (  ) to the right of “Folder Setup”.



**3** Click the shared folder that you want to give a quota.

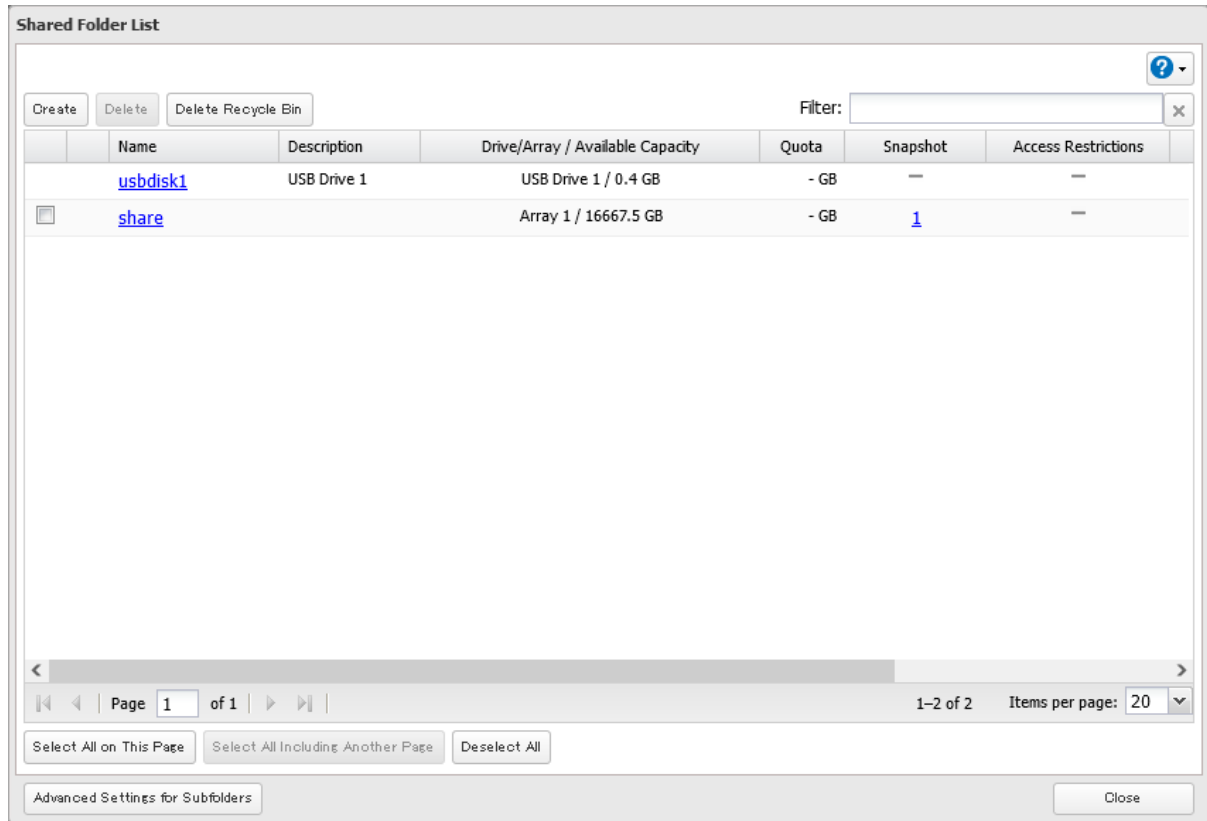

**4** Click the *Option 1* tab.

**5** Enable "Quota" and choose the alert and the maximum amount of space the user will be allowed to use, then click OK.

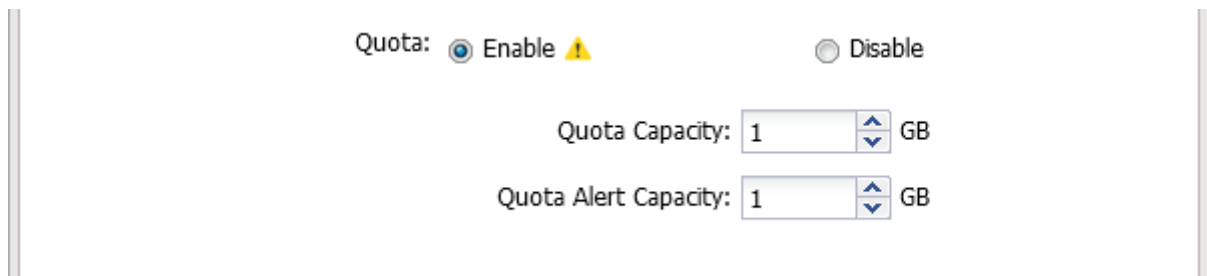

**6** The process is complete once you close the confirmation window that appears.

## Limits for LVM Volumes

If LVM is enabled, volumes can be created with maximum size limits.

### Notes:

- When creating an LVM volume, all data in the area you specified for the LVM volume will be erased. Before changing any settings, back up any important data.
- Do not use any of the following words for the name of a volume as these words are reserved for internal use by the TeraStation: array *x*, authstest, disk *x*, global, homes, info, lost+found, lp, medicartridge *x*, msdfs\_root, mt-daapd, printers, ram, spool, usbdisk *x*. Any instances of "x" denote a number (for example: array1 or disk3)

1 From Settings, click *Storage*.



2 Click the settings icon (  ) to the right of "LVM".



3 Select the drive or array where the volume will be located and click *Enable LVM*.

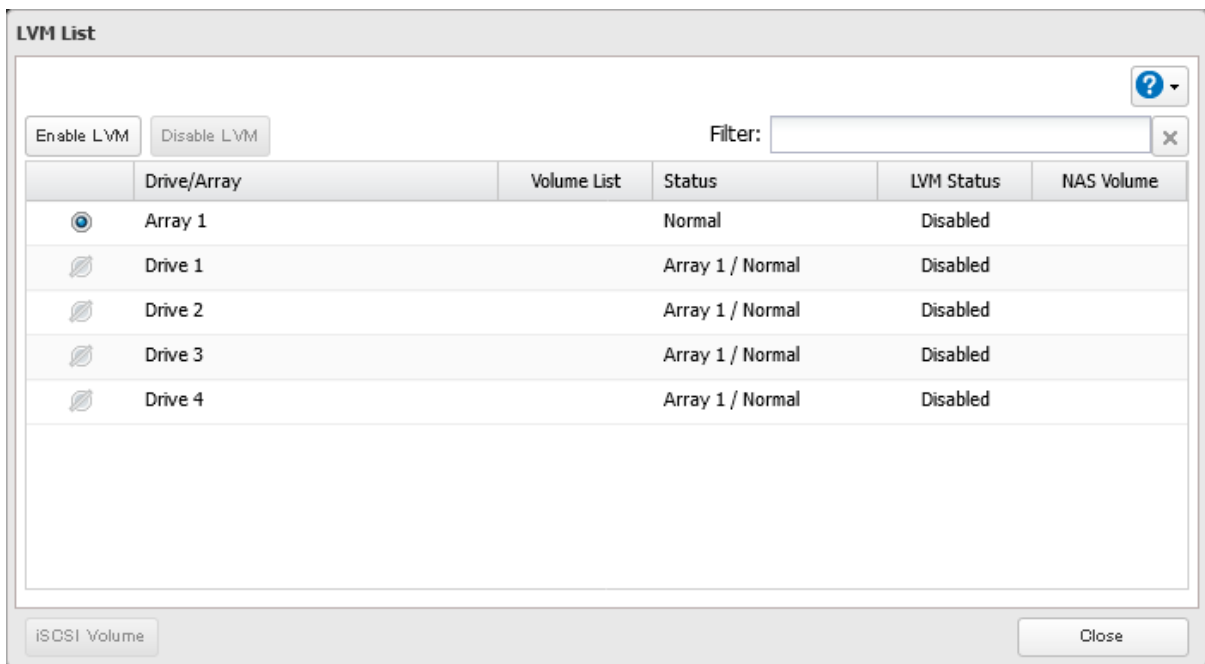

4 Read the message carefully and click *Yes*.

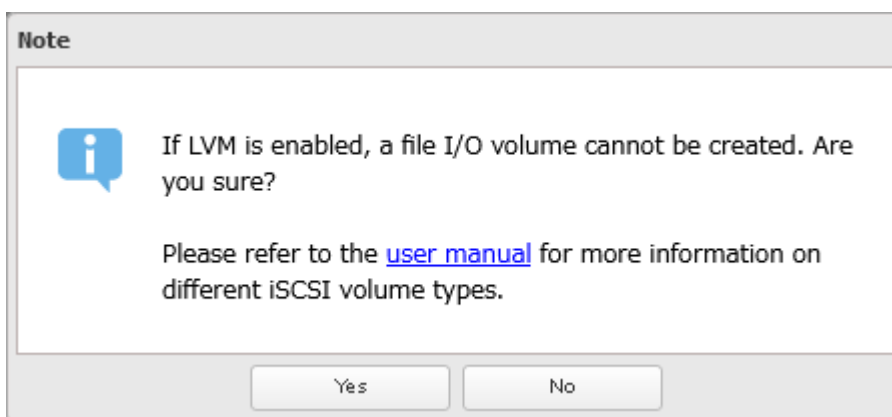

5 The "Confirm Operation" screen will open. Enter the confirmation number, then click *OK*.

**6** Click *Edit* under “NAS Volume”.

**LVM List**

Enable LVM    Disable LVM    Filter:

	Drive/Array	Volume List	Status	LVM Status	NAS Volume
<input checked="" type="radio"/>	Array 1	Show	LVM Enabled / Normal	Enabled	Edit
<input type="radio"/>	Drive 1		Array 1 / Normal	Disabled	
<input type="radio"/>	Drive 2		Array 1 / Normal	Disabled	
<input type="radio"/>	Drive 3		Array 1 / Normal	Disabled	
<input type="radio"/>	Drive 4		Array 1 / Normal	Disabled	

iSCSI Volume    Close

**7** Click *Create Volume*.

**NAS Volume List: Array 1**

Create Volume    Delete Volume    Filter:

	Volume Name	Total Capacity	Used Capacity	% Used
--	-------------	----------------	---------------	--------

Close

8 Enter a volume name and size, then click *OK*.

9 The process is complete once you close the confirmation window that appears.

The usable capacity can now be limited by selecting the volume that you created for “Drive/Array” on the *Basic* tab when creating a shared folder.

**Notes:**

- If you click *Show* under “Volume List”, the volumes will be listed on the screen and you can see if these volumes are being used as iSCSI or NAS.
- If an LVM volume could not be mounted, try restarting the TeraStation. If an issue still exists, delete the LVM volume and recreate it. Deleting the LVM volume will erase all data on the volume.
- The available capacity will be less than the capacity you entered when creating an LVM volume. This is because some free space will be occupied by the system.

---

## Using the TeraStation as an iSCSI Device

---

### Introduction

iSCSI is a protocol for carrying SCSI commands over IP networks. Unlike traditional SAN protocols such as Fibre Channel, which requires special-purpose cabling, iSCSI can be run over long distances using existing network infrastructure. Normal Windows formatting such as NTFS is supported.

### Differences Between NAS and iSCSI

With iSCSI, the TeraStation is connected to a single computer, such as a server. Other computers on the network access files on the TeraStation through the computer it’s connected to. The TeraStation can be used as a local drive from Windows Server. Features of Windows Server such as Active Directory can be used normally.

As a NAS, the TeraStation is a server, and computers (including other servers) on the network can access shared folders on it directly. A separate server is not required, and features such as backup are built-in.

### Network Configuration

Use gigabit or faster network equipment with iSCSI. For best results, a dedicated network for iSCSI is recommended, separate from the regular network. By default, the IP address of the TeraStation is automatically assigned from a DHCP server. However, in this case, if you turn off and restart the TeraStation, the IP address may be changed and the volumes on the TeraStation may not be accessible. To avoid changing the IP address unexpectedly, using a static IP address for the TeraStation is recommended.

## Connection Tool

The Microsoft iSCSI Software Initiator is already installed on your computer. You don't need to download and install it.

## Creating an iSCSI Volume

To use the TeraStation as an iSCSI drive, create a volume first. Configure the TeraStation as described below.

### Notes:

- If the volume settings are changed, all data on the volume will be erased. Before changing any settings, back up any important data.
- The TeraStation can have up to 255 volumes, but we recommend creating no more than 32. Exceeding this volume amount may cause irreparable damage to the unit.
- Do not use a name already in use as a shared folder name; do not use any of the following words for the name of a volume as these words are reserved for internal use by the TeraStation: array *x*, authtest, disk *x*, global, homes, info, lost+found, lp, mediacartridge *x*, msdfs\_root, mt-daapd, printers, ram, spool, usbdisk *x*. Any instances of "x" denote a number (for example: array1 or disk3)
- There are two options for the "Backstore" setting to select the type of iSCSI volume. Refer to the differences below.

- **File I/O:** This type of volume can specify the volume size and multiple volumes can be created on one drive or RAID array. This also allows you to expand the volume size after the volume is created and data has been stored.

Snapshots can be created on the iSCSI volume. The volume can also be set as a backup folder. However, be careful in regards to the free space on the volume being used for snapshots. The actual free space will be smaller than the value displayed on the Properties window in Windows. Use the Dashboard in Settings to verify the actual free space.



- **Block I/O:** This type of volume will create an iSCSI volume for a whole drive or RAID array. However, if you enable LVM, you can create multiple volumes on the drive or the RAID array or expand the volume size later, just like a file I/O volume. It is recommended to enable LVM if you want to create multiple volumes on one drive or RAID array, or expand the volume later.

Block I/O volumes afford higher performance than file I/O volumes because there is less latency when bypassing the file system layer required for file I/O.

**Be aware that block I/O volumes with LVM enabled cannot use snapshots. The volumes also cannot be used as the backup folders.**

- 1 From Settings, click *Storage*.



- 2 Move the iSCSI switch (  ) to the  position to enable iSCSI.



- 3 Click the settings icon (  ) to the right of "iSCSI".



#### 4 Click *Create Volume*.

The screenshot shows the 'iSCSI Settings' window with the 'General' tab selected. At the top, there are tabs for 'General', 'Security', and 'Internet Storage Name Service (ISNS)'. Below these are buttons for 'Create Volume', 'Delete Volume', 'Enable Connection', 'Disable Connection', 'Show Snapshot List', and 'Refresh'. A table with the following columns is visible: Status, Volume Name, Backstore, Drive/Array, Target Name, Authentication, and Capacity. The table is currently empty. At the bottom, there is a pagination bar showing 'Page 1 of 1', 'No data available.', and 'Items per page: 20'. There are also buttons for 'Select All on This Page', 'Select All Including Another Page', 'Deselect All', 'Show Active Connections', and 'Close'.

#### 5 Enter a volume name, volume description, drive or array where a volume will be created, and volume size, then click *OK*.

If you enabled LVM for the target drive or array, or selected "File I/O" for the "Backstore" option, the volume size that you specify here can be changed later. To change the volume size, refer to the ["Expanding Volume Sizes"](#) section below.

The screenshot shows the 'iSCSI Volume Settings' dialog box. It has a 'General' tab and a '\*Required' indicator. The 'General' section contains the following fields and options:

- Backstore:** Radio buttons for  File I/O and  Block I/O.
- Volume Connection:** Radio buttons for  Enable and  Disable.
- Volume Name \*:** Text input field containing 'volume01'.
- Description:** Empty text input field.
- Drive/Array:** Dropdown menu showing 'Array 1 (LVM disabled) / 897 GB'.
- Capacity:** Spinners for '10' and 'GB / Remaining 887 GB'.

The 'Authentication' section is currently disabled (greyed out) and contains:

- Radio buttons for  Enable and  Disable.
- Target CHAP Name \*:
- Target CHAP Secret \*:
- Mutual Authentication:  Enable
- Initiator CHAP Secret:

At the bottom, there are buttons for 'Advanced Settings', 'OK', and 'Cancel'.

**6** Read the message carefully and click *OK*.

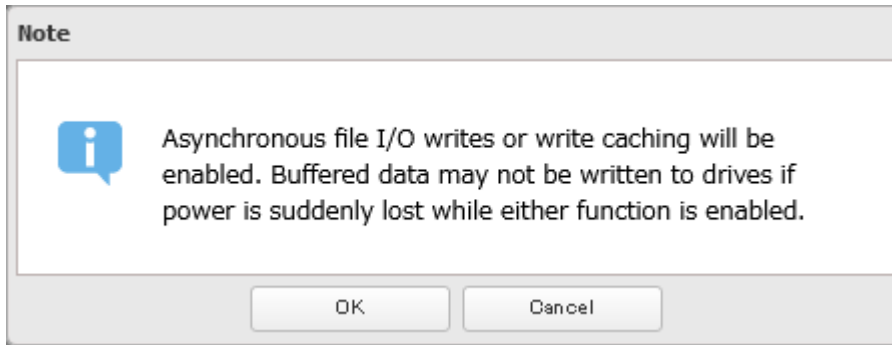

**7** The process is complete once you close the confirmation window that appears.

**Notes:**

- Do not use the TeraStation's whole capacity for iSCSI volumes. Some features need free space in order to function. If there is no available free space, it may cause unexpected behavior.
- If you click *Disable Connection* for the selected volume in *Storage > iSCSI* in Settings, the selected iSCSI volume can no longer be accessed. If you click *Enable Connection*, the volume will become accessible from the iSCSI initiator software.
- If you selected "Block I/O" for the "Backstore" option, write cache (WCE) cannot be configured from the "Advanced Settings" page.

## Connecting Volumes

---

To connect a volume, follow the procedure below.

**Notes:**

- When changing iSCSI volume settings, the iSCSI service will restart so iSCSI volumes will be unable to connect temporarily. It is recommended to disconnect the volume before changing the volume settings.
- Do not shut down the TeraStation while connecting to an iSCSI volume. It may cause unexpected data erasure. Make sure all connections are disconnected before shutdown.

**1** From Windows, navigate to *Control Panel > System and Security > Administrative Tools > iSCSI Initiator*.

**2** Enter the IP address of the TeraStation into the "Target" field and click *Quick Connect*.

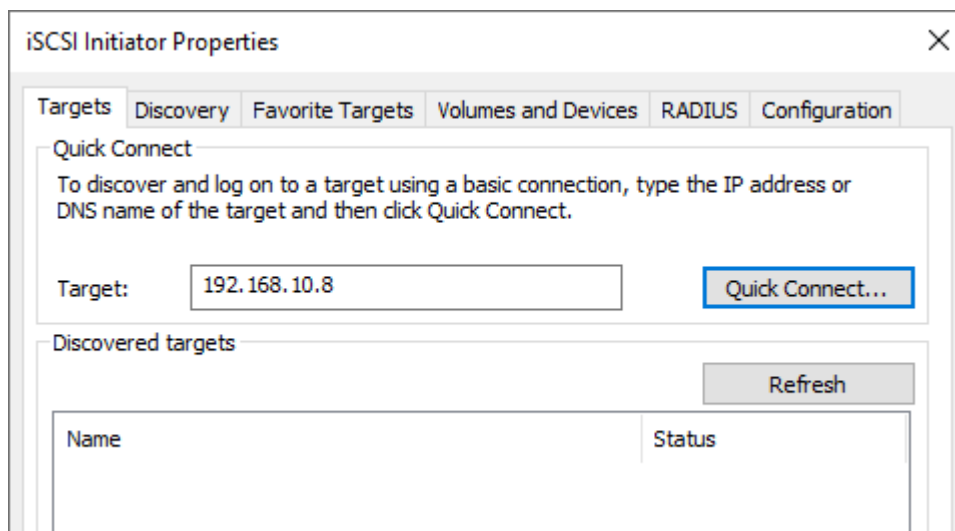

**3** Confirm if the connection is established and click *Done*.

- 4 The process is complete when the status of the selected volume is displayed as “Connected” on the iSCSI initiator.

You can also check that the volume status is “Connected” in Settings by navigating to *Storage > iSCSI*.

## Using with Multiple Computers

If the TeraStation is divided into multiple volumes (or drives), it can be used with multiple computers. However, it is not recommended to access a single volume or drive from multiple computers at the same time for security reasons. When using the TeraStation as an iSCSI device, it should only connect to a single initiator unless the computer running the initiator also has clustering enabled and configured on its operating system. To avoid using multiple initiators for access, enable mutual authentication.

## Formatting Volumes

---

If using the connected volume for the first time, the volume should be formatted to be used as a local drive. Follow the procedure below for formatting.

- 1 From Windows, navigate to *Control Panel > System and Security > Administrative Tools > Computer Management*.
- 2 Click *Disk Management*.  
When the “Initialize Disk” screen appears, click *OK* without changing any settings.
- 3 Right-click the drive volume that shows the status “Unallocated” and click *New Simple Volume* from the displayed menu. Follow the screen to finish formatting.
- 4 The process is complete when the drive is visible as an icon in *Computer* or *This PC* and can be used as a normal drive on the computer.

## Disconnecting Volumes

---

To disconnect a volume, follow the procedure below.

- 1 From Windows, navigate to *Control Panel > System and Security > Administrative Tools > iSCSI Initiator*.  
The status of the connecting volume will be displayed as “Connected” under “Discovered targets”.
- 2 Select a volume to disconnect and click *Disconnect*.
- 3 Click *Yes*.
- 4 The process is complete when the volume status is displayed as “Inactive” on the iSCSI initiator.

## Configuring Access Restrictions

---

A CHAP name and secret can be configured for the entire iSCSI volume or each existing volume. Access restrictions can be configured so that entering a target CHAP name and secret is required for each connection. The TeraStation can perform mutual authentication (two-way authentication). Dual passwords ensure that only authorized client computers can access the volume on the TeraStation.

## Configuring for the Entire TeraStation

Follow the procedure below to enable access restrictions for the entire TeraStation.

- 1 From Settings, click *Storage*.



2 Click the settings icon (  ) to the right of "iSCSI".



3 Click the *Security* tab.

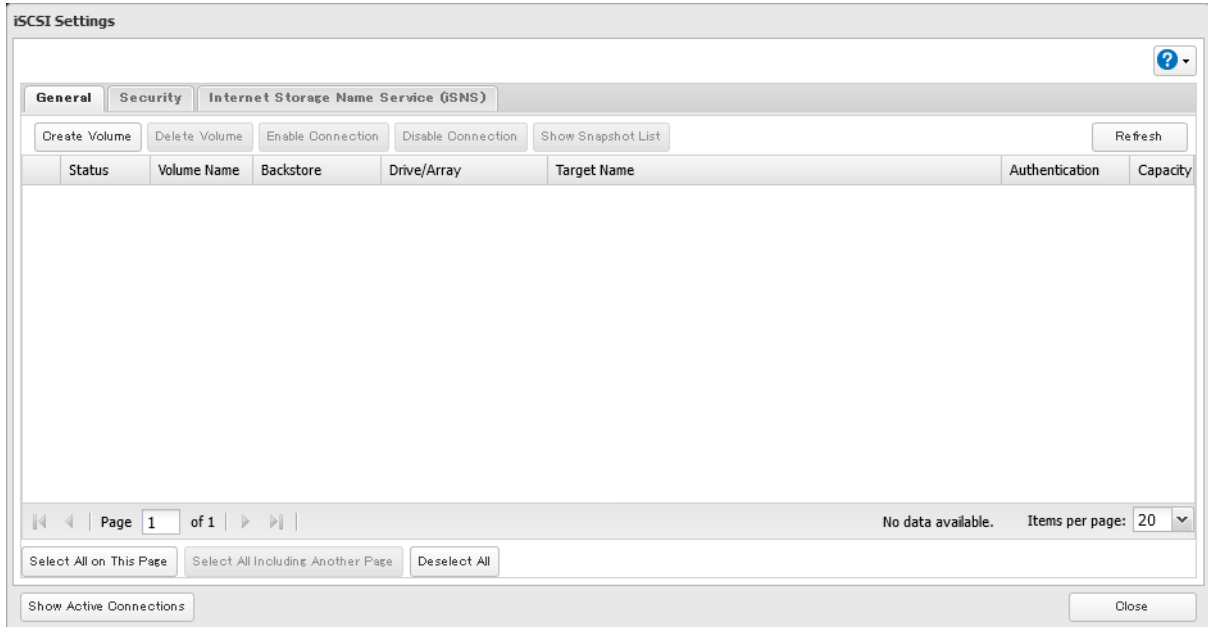

4 Click *Edit*.

5 Enable "Authentication" and enter the target CHAP name and secret, then click *OK*.

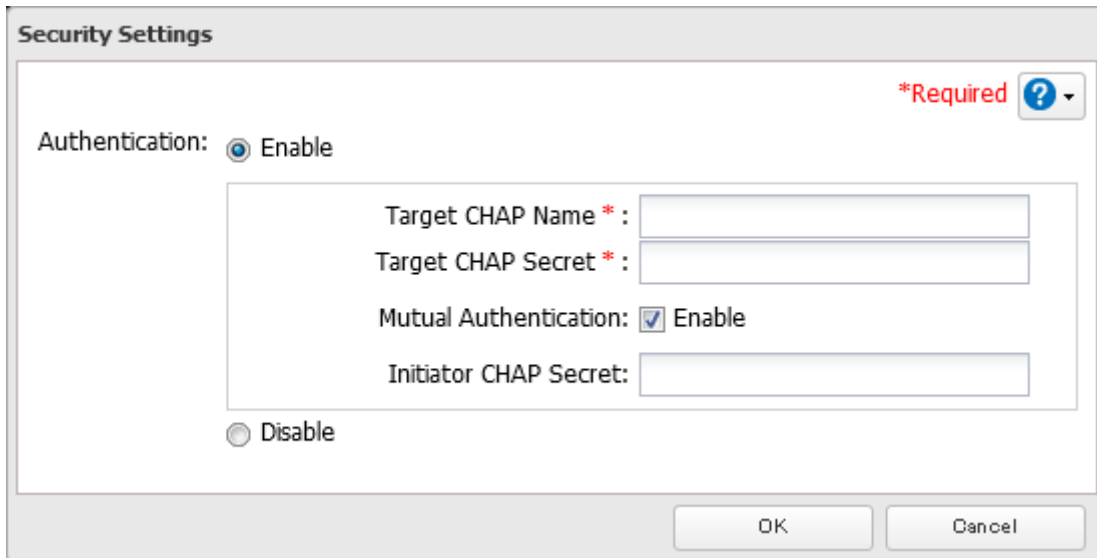

**Note:** To enable mutual authentication in addition to target CHAP name and secret authentication, select the "Enable" checkbox for "Mutual Authentication" and enter the initiator CHAP secret.

To search or connect the volume which has mutual authentication enabled from Microsoft iSCSI Initiator, initiator CHAP secret settings should be configured.

6 The process is complete once you close the confirmation window that appears.

## Configuring for Individual Volumes

Follow the procedure below to configure access restrictions for individual volumes.

- 1 From Settings, click *Storage*.



- 2 Click the settings icon (  ) to the right of "iSCSI".

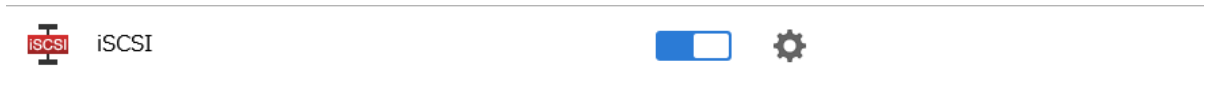

- 3 Click the volume to enable access restrictions.

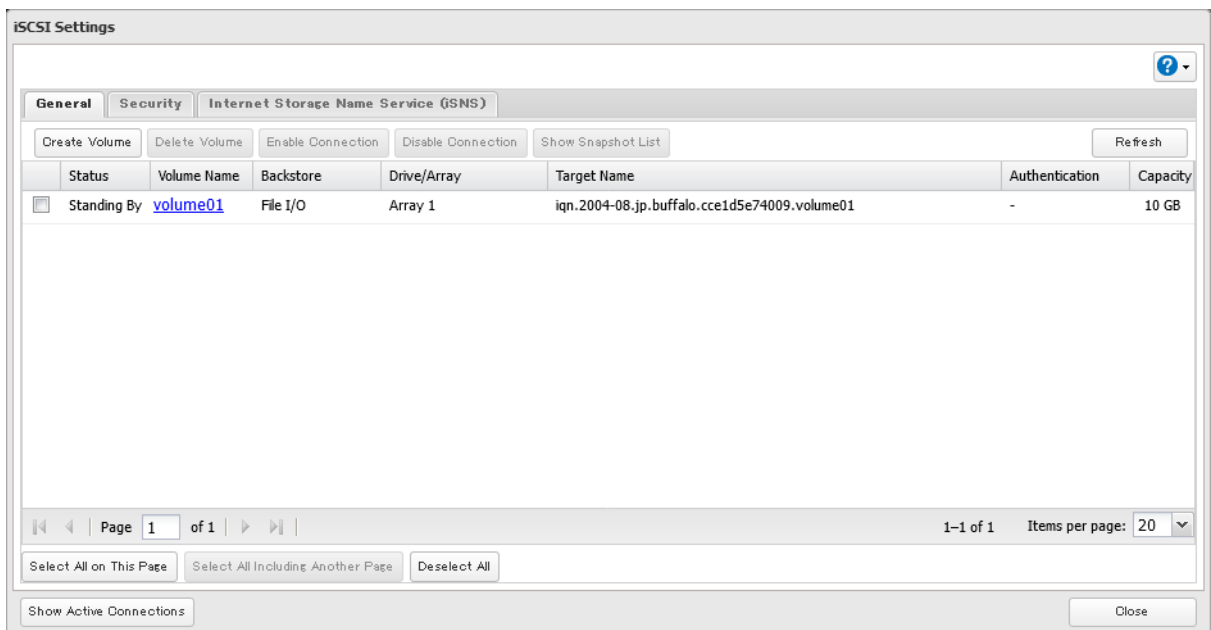

- 4** Enable “Authentication” and enter the target CHAP name and secret, then click *OK*.

**iSCSI Volume Settings** \*Required ?

**General**

Backstore: File I/O

Volume Connection:  Enable  Disable

Volume Name: volume01

Description:

Drive/Array: Array 1 / 5556 GB

Capacity: 10 GB +  GB = 20 GB / Remaining 5534 GB

Target Name: iqn.2004-08.jp.buffalo.cce1d5e74009.volume01

**Authentication:  Enable**

Target CHAP Name \* :

Target CHAP Secret \* :

Mutual Authentication:  Enable

Initiator CHAP Secret:

Disable

Advanced Settings OK Cancel

**Note:** To enable mutual authentication in addition to target CHAP secret authentication, select the “Enable” checkbox for “Mutual Authentication” and enter the initiator CHAP secret.

- 5** The process is complete once you close the confirmation window that appears.

## Connecting Access-Restricted Volumes

### Connecting if Volume Access Is Restricted

If access restrictions are configured for the entire iSCSI volume, that volume will not be detected by Microsoft iSCSI Initiator. To connect that volume, the target CHAP name and secret should be authenticated.

- 1** Open the Microsoft iSCSI Initiator.
- 2** Register the initiator CHAP secret to your computer first. If you didn’t enable mutual authentication, skip this step.  
Click *CHAP* on the *Configuration* tab. Enter the configured initiator CHAP secret into the “Initiator CHAP secret” field and click *OK*.
- 3** From the *Discovery* tab, click *Discover Portal*.
- 4** Enter the TeraStation’s IP address into the “IP address or DNS name” field and click *Advanced*.
- 5** Select the “Enable CHAP log on” checkbox and enter the target CHAP name into the “Name” field and the target CHAP secret into the “Target secret” field.  
If mutual authentication is enabled, select the “Perform mutual authentication” checkbox.

- 6** Click *OK*, then click *OK* again.
- 7** The iSCSI volumes on the TeraStation will be listed under “Discovered targets” on the *Targets* tab. Select the desired volume to connect and click *Connect*.
- 8** The process is complete when the status of the selected volume is displayed as “Connected” on the iSCSI initiator.

## Connecting if Volume Access Is Partially Restricted

- 1** Open the Microsoft iSCSI Initiator.
- 2** Register the initiator CHAP secret to your computer first. If you didn’t enable mutual authentication, skip this step.  
Click *CHAP* on the *Configuration* tab. Enter the configured initiator CHAP secret into the “Initiator CHAP secret” field and click *OK*.
- 3** From the *Discovery* tab, click *Discover Portal*.
- 4** Enter the TeraStation’s IP address into the “IP address or DNS name” field and click *OK*.
- 5** The iSCSI volumes on the TeraStation will be listed under “Discovered targets” on the *Targets* tab. Select the desired volume to connect and click *Connect*.
- 6** Click *Advanced*.
- 7** Select the “Enable CHAP log on” checkbox and enter the target CHAP name into the “Name” field and the target CHAP secret into the “Target secret” field.  
If mutual authentication is enabled, select the “Perform mutual authentication” checkbox.
- 8** Click *OK*, then click *OK* again.
- 9** The process is complete when the status of the selected volume is displayed as “Connected” on the iSCSI initiator.

## Expanding Volume Sizes

---

The volume size of the existing volumes can be expanded after they are created.

### Notes:

- Expanding the volume size may erase all data on the volume depending on the formatting type. Backing up the data before expanding the volume size is recommended.
- To expand the volume size, the volume should have “File I/O” selected for the “Backstore” option, or the volume needs to have been created on a drive or array that has LVM enabled.

- 1** From Settings, click *Storage*.



2 Click the settings icon (  ) to the right of "iSCSI".

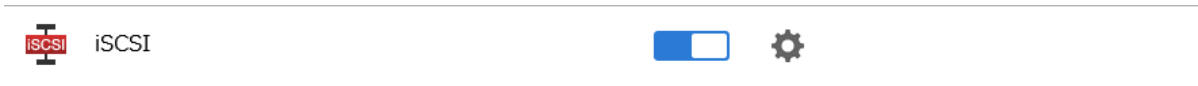

3 Select the volume to expand.

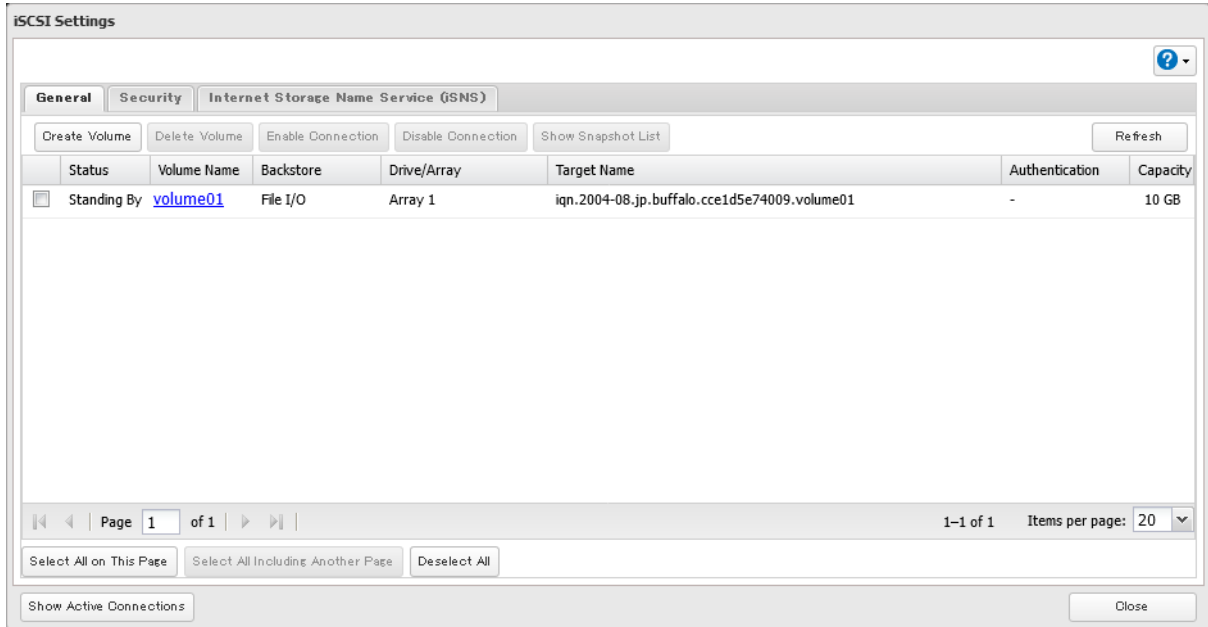

4 Enter the desired volume size to add and click OK.

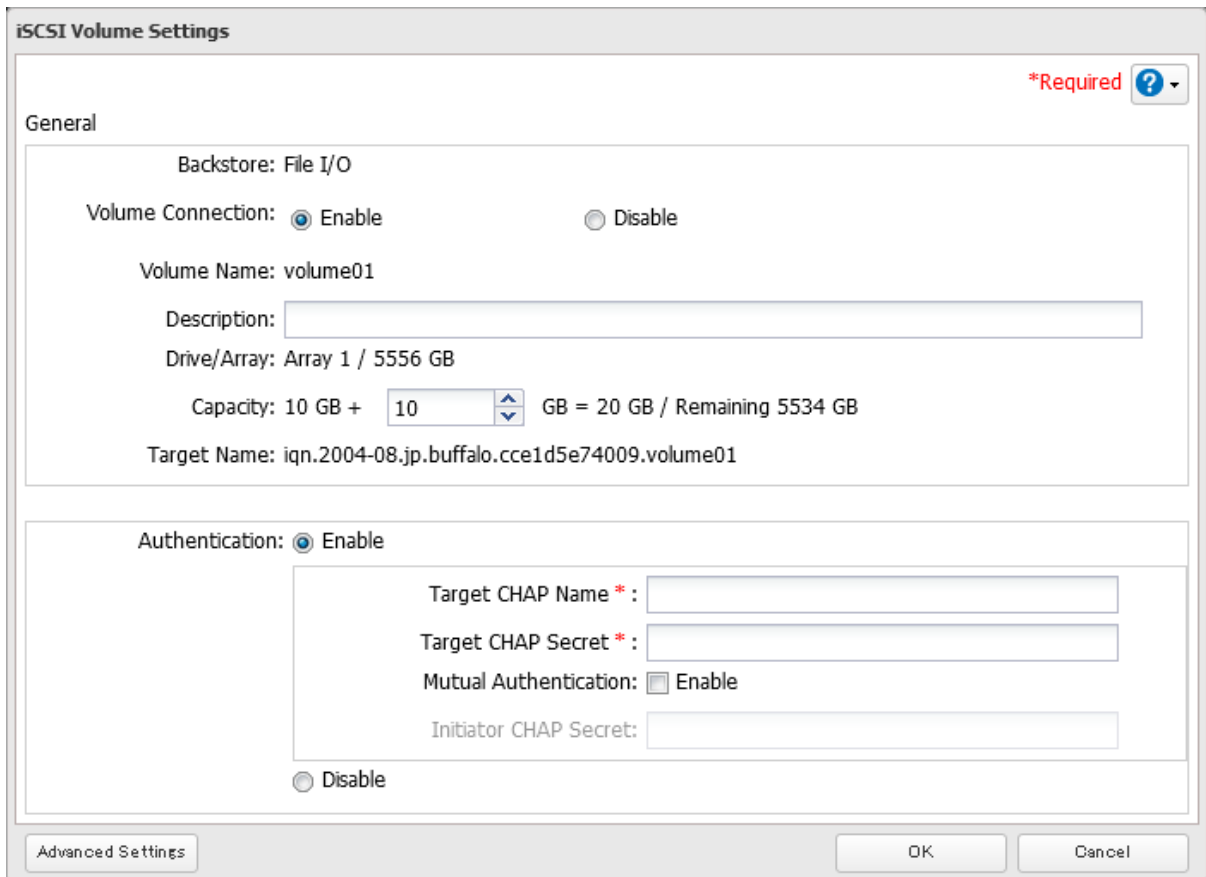

**5** The process is complete once you close the confirmation window that appears.

## Deleting Volumes

To delete an existing volume, follow the procedure below.

**Note:** Deleting a volume will erase all data on the volume. Back up the data before deleting the volume.

**1** From Settings, click *Storage*.



**2** Click the settings icon (  ) to the right of "iSCSI".



**3** Select the volume to delete and click *Delete Volume*.

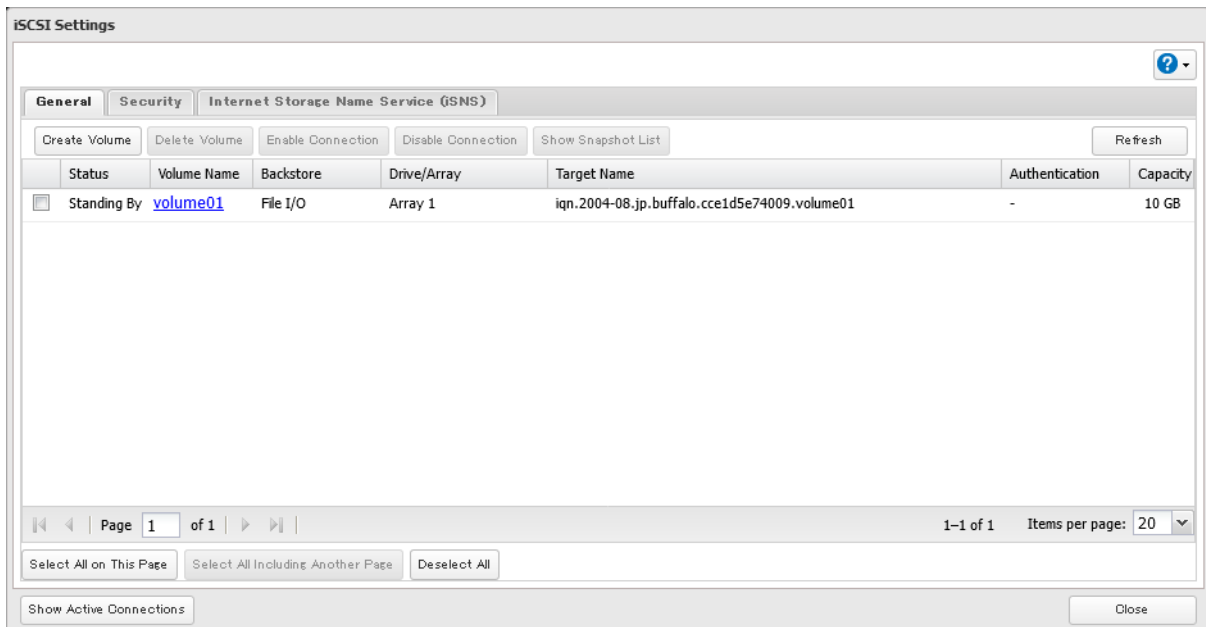

**4** Confirm that the volume is correctly selected on the screen and click *OK*.

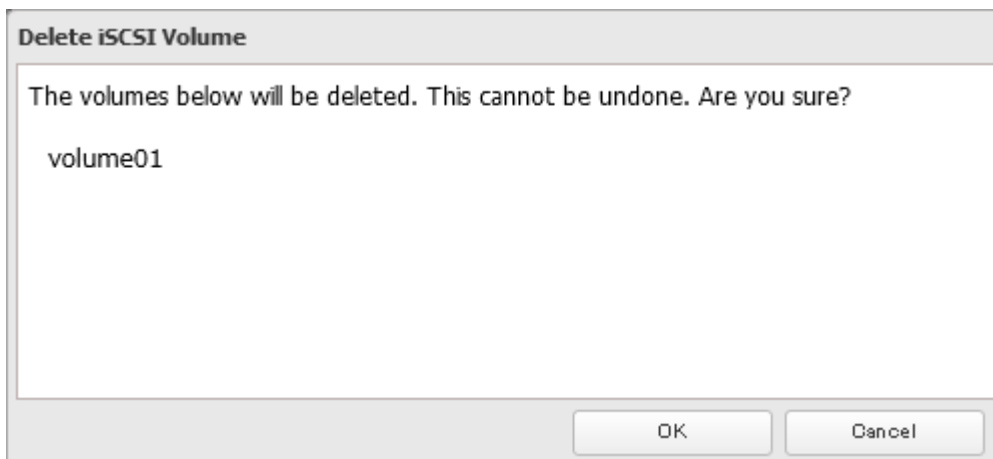

- 5 The “Confirm Operation” screen will open. Enter the confirmation number, then click *OK*.
- 6 The process is complete once you close the confirmation window that appears.

## Enabling the iSNS Protocol

By enabling the iSNS protocol on the TeraStation, you can register an iSCSI target (volume) to an iSNS server and use it to manage the registered targets. To enable the iSNS protocol, follow the procedure below.

- 1 From Settings, click *Storage*.



- 2 Click the settings icon (  ) to the right of “iSCSI”.

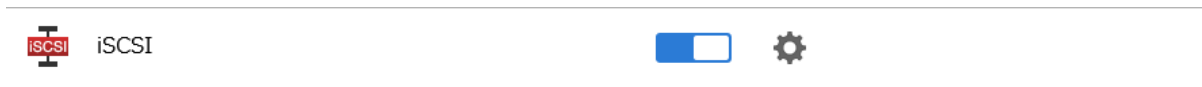

- 3 Click the *Internet Storage Name Service (iSNS)* tab.

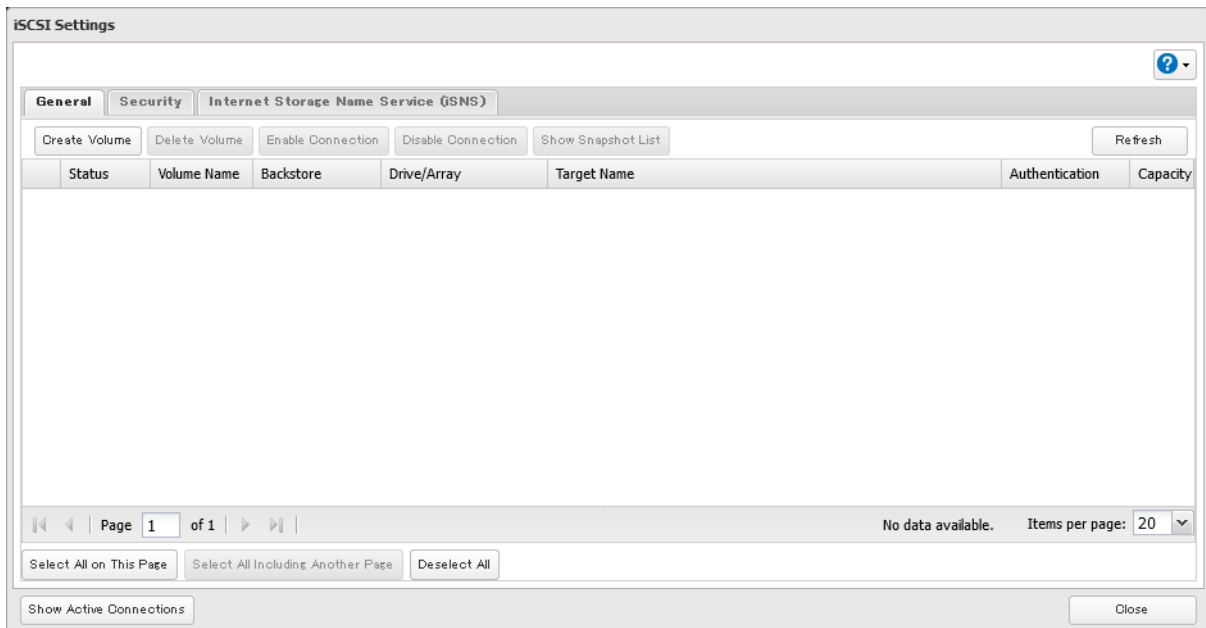

- 4 Click *Edit*.

- 5** Enable “iSNS” and enter the IP address or hostname of the iSNS server, then click *OK*.

- 6** The process is complete once you close the confirmation window that appears.

## Advanced iSCSI Volume Settings

You can configure the following advanced parameters for each iSCSI volume.

Advanced Parameter	Description
HeaderDigest	Controls the HeaderDigest usage by the iSCSI target portal group endpoint.
DataDigest	Controls the DataDigest usage by the iSCSI target portal group (TPG) endpoint.
MaxConnections	Controls the usage of Multiple Connections per Session (MC/S). Initiator and target negotiate the maximum number of connections requested and/or acceptable.
InitialR2T	Turns the default use of R2T (Ready to Transfer) on or off for unidirectional and the output part of bidirectional commands.
ImmediateData	Indicates whether the initiator and target have agreed to support immediate data on this session.
MaxRecvDataSegmentLength	Maximum data segment length in bytes the initiator and target can receive in an iSCSI Protocol Data Unit (PDU).
MaxXmitDataSegmentLength	Maximum data segment length in bytes that can be sent.
MaxBurstLength	Maximum iSCSI data payload in a Data-In or a solicited Data-Out iSCSI sequence, in bytes.
FirstBurstLength	Maximum amount in bytes of unsolicited data an iSCSI initiator can send to the target during the execution of a single SCSI command.
MaxOutstandingR2T	The R2T PDUs that can be in transition before an acknowledge PDU is received.
QueuedCommands	Maximum number of commands queued to any session of this target.
File I/O Write Sync	Synchronous file I/O provides reliability but slower performance. Asynchronous writes are faster, but buffered data will be lost if a power outage occurs.
Write Cache (WCE)	Increases performance. This cannot be used when block I/O is selected.
LUN	Number used to identify a local unit.

# Chapter 5 Backup

---

## Snapshots

---

### Overview

---

Snapshot is a function that creates a virtual copy of the data currently stored in a shared folder or iSCSI volume on the TeraStation. Once a snapshot has been created and saved, files and folders that are subsequently modified or deleted can be restored from the point at which the snapshot was created. The TeraStation allows you to not only create a snapshot manually, but also schedule automatic snapshots and auto-archive them to save TeraStation capacity.

Snapshots are saved to the read-only area, so they cannot be modified or deleted. Even if the network suffers a ransomware attack and files on the TeraStation are encrypted, you can revert files to a previously uninfected state from snapshots.

The created snapshots will be saved on the TeraStation. As with any file, if a drive malfunctions, all saved snapshots on that drive will be erased along with the data.

While snapshots can be used for short-term file backup and recovery, they should not be your sole data backup method.

### Application for iSCSI Volume Snapshots

---

To create an iSCSI volume snapshot in the environment where the iSCSI volumes on the TeraStation are connected using a virtual machine, we recommend using the Buffalo-offered Windows Server application “Snapshot Agent for TeraStation”, available from the [Buffalo website](#).

The application can create both application-consistent and crash-consistent snapshots. An application-consistent snapshot contains all current data in memory and all I/O operations. Restoring from an application-consistent snapshot reverts the volume to the exact same state as when the snapshot was created. A crash-consistent snapshot, on the other hand, creates a snapshot of all the current files but not ongoing processes. Restoring from a crash-consistent snapshot only recovers saved data. Refer to the application help for detailed usage procedures.

### Manually Creating a Snapshot

---

To create a snapshot for the shared folder or the iSCSI volume, follow the procedure below.

#### Notes:

- If an unexpected error occurs while taking a snapshot, you may have run out of available space. If this is the case, delete or move files to another location and try again.
- Up to 1,024 snapshots can be created for either a shared folder or an iSCSI volume. We recommend keeping no more than 65,536 snapshots total on a TeraStation. If you have created more than 65,536 snapshots, it may result in unexpected system behavior and slowdown.

### For Shared Folders

- 1 From Settings, click *File Sharing*.



**2** Click the settings icon (  ) to the right of "Folder Setup".



**3** Click the number under "Snapshot" for the shared folder on the shared folder list.

**Shared Folder List**

Create Delete Delete Recycle Bin Filter:

	Name	Description	Drive/Array / Available Capacity	Quota	Snapshot	Access Restrictions
	<a href="#">usbdisk1</a>	USB Drive 1	USB Drive 1 / 0.4 GB	- GB	—	—
<input type="checkbox"/>	<a href="#">share</a>		Array 1 / 16667.5 GB	- GB	<a href="#">1</a>	—

Page 1 of 1 1-2 of 2 Items per page: 20

Select All on This Page Select All Including Another Page Deselect All

Advanced Settings for Subfolders Close

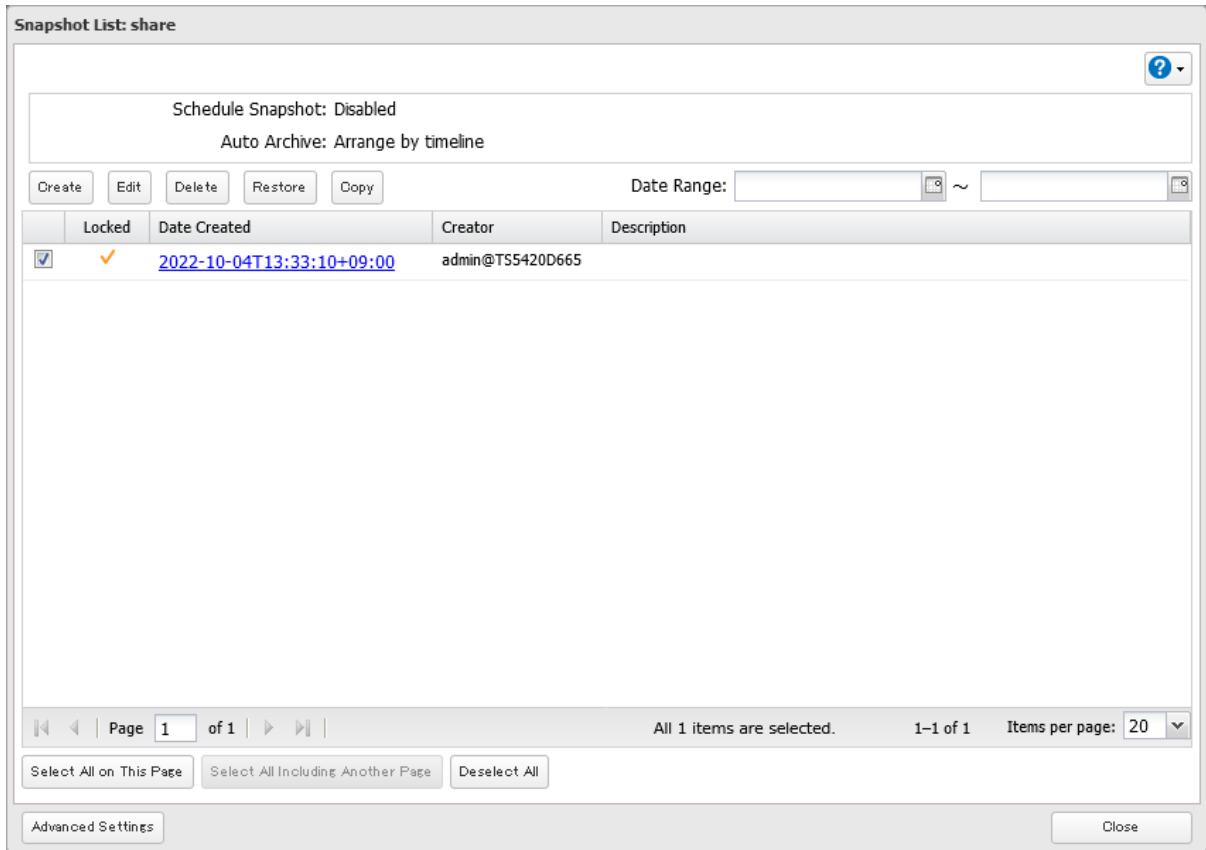
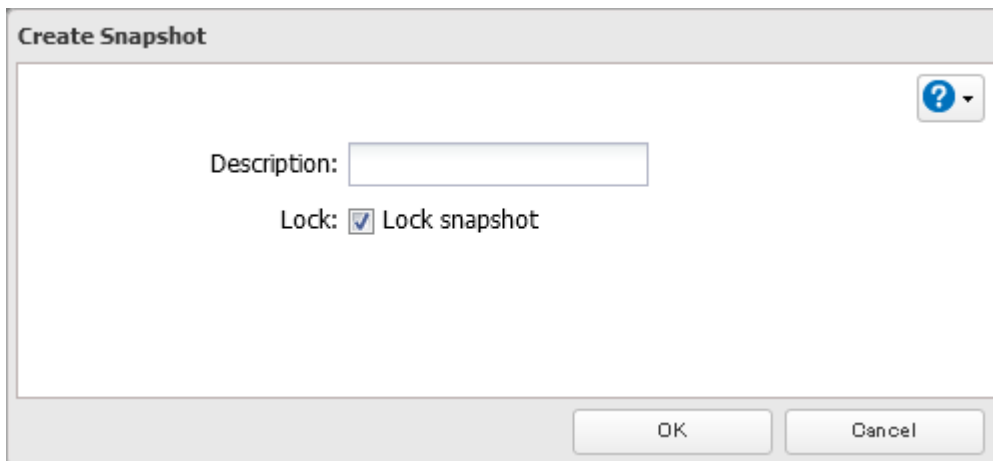
**4** Click *Create*.**5** Select or clear the “Lock” checkbox to determine whether the created snapshot will be locked or unlocked and enter a short description, then click *OK*. A locked snapshot cannot be deleted due to auto-archiving.**6** The process is complete once you close the confirmation window that appears.**For iSCSI Volumes****1** From Settings, click *Storage*.

2 Click the settings icon (  ) to the right of "iSCSI".



3 Select the checkbox for the target iSCSI volume and click *Show Snapshot List*.

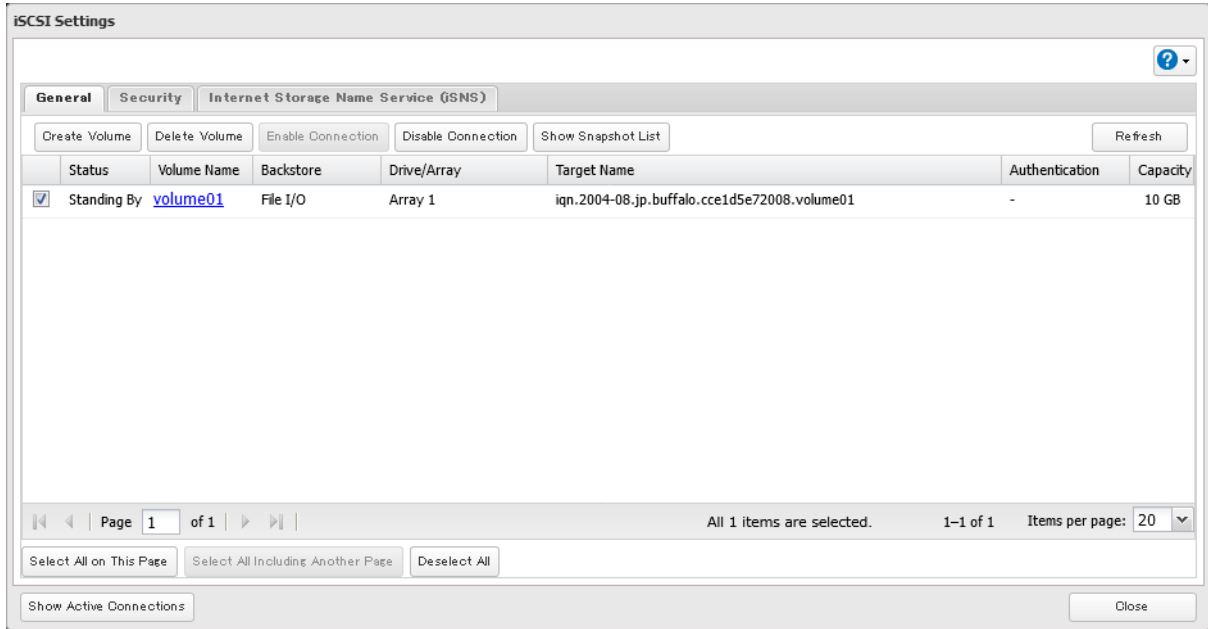

4 Click *Create*.

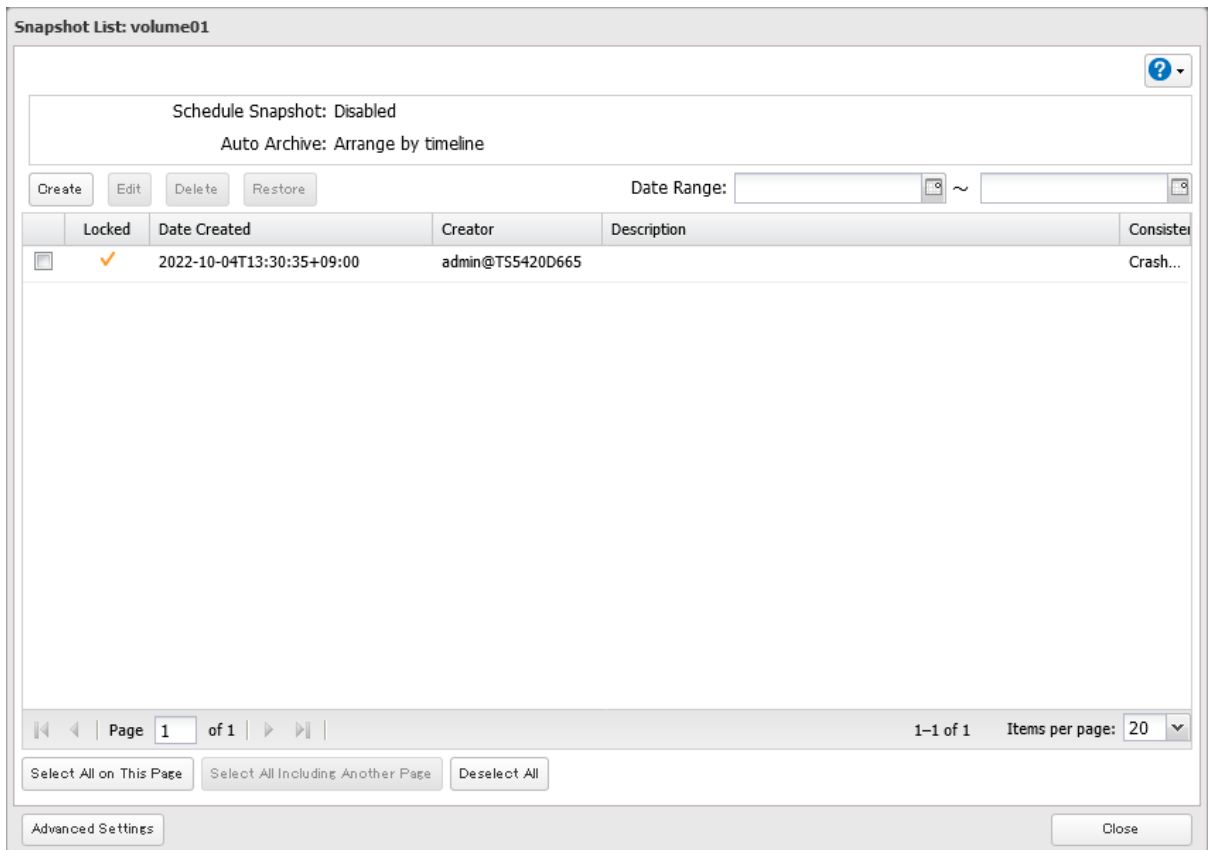

- 5** Select or clear the “Lock” checkbox to determine whether the created snapshot will be locked or unlocked and enter a short description, then click *OK*. A locked snapshot cannot be deleted due to auto-archiving.

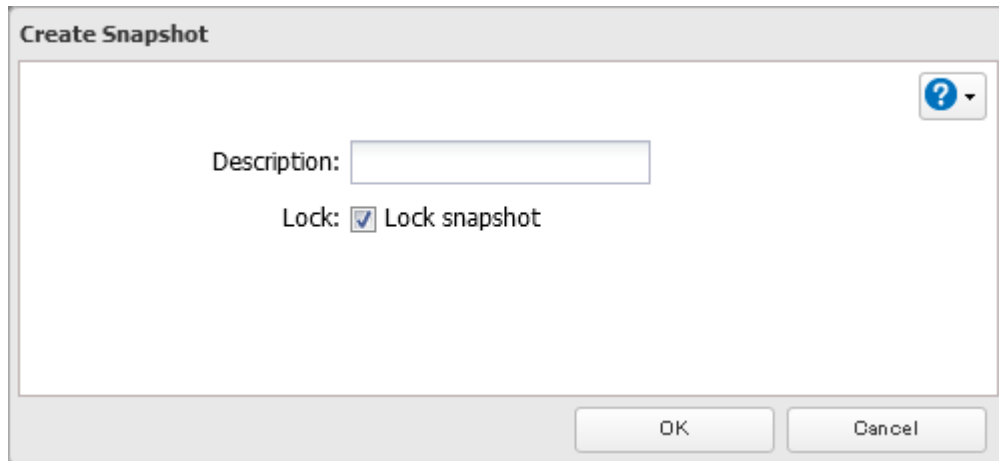

- 6** The process is complete once you close the confirmation window that appears.

## Accessing the Snapshots via SMB

---

From a Windows computer, you can access snapshots using the “Restore previous versions” option.

- 1** From Settings, click *File Sharing*.

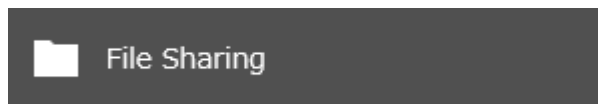

- 2** Click the settings icon (  ) to the right of “Folder Setup”.



**3** Click the shared folder to access snapshots from the computer.

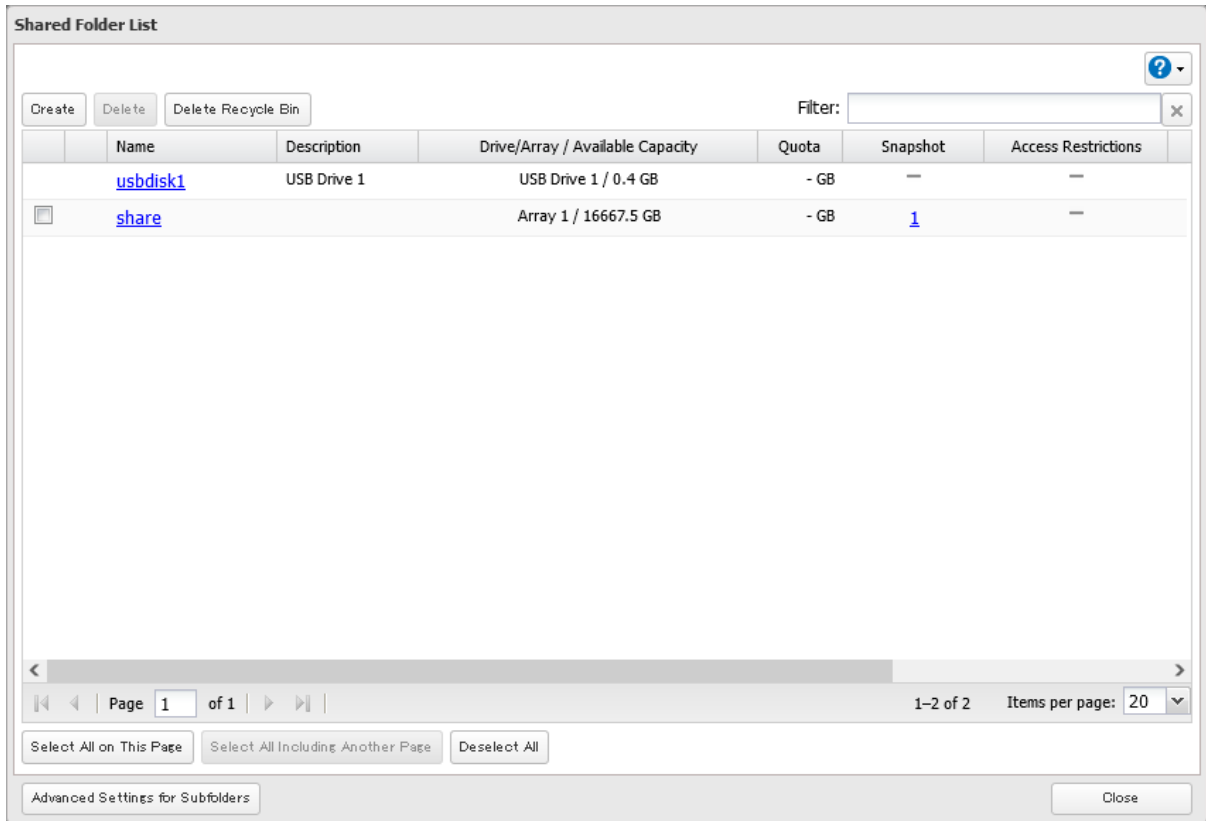

**4** Click the *Option 2* tab.

**5** Enable “Shadow Copy” and click *OK*.

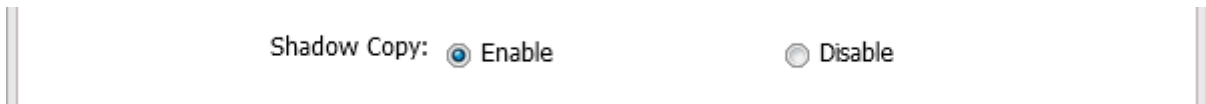

**6** From the computer, access the TeraStation using File Explorer and right-click the shared folder to view snapshots.

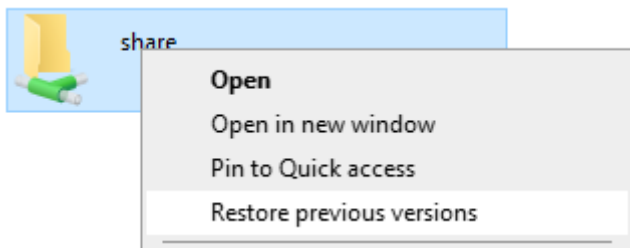

**7** Click *Restore previous versions*.

- 8** The entire history of created snapshots will appear. Select the snapshot and the action to be taken for the snapshot.

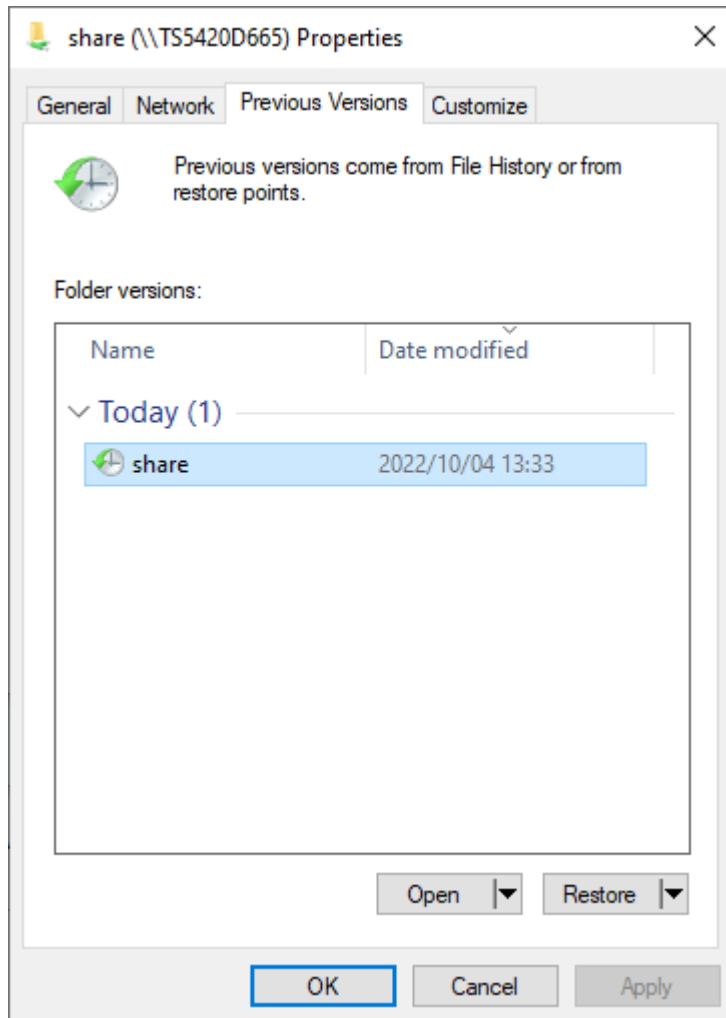

## Restoring Snapshots

To restore the created snapshots to the shared folder or the iSCSI volume, follow the procedure below.

### For Shared Folders

**Note:** When restoring snapshots, the file sharing service will restart so shared folders will become inaccessible temporarily.

- 1** From Settings, click *File Sharing*.



- 2** Click the settings icon (  ) to the right of "Folder Setup".



**3** Click the number under “Snapshot” for the shared folder on the shared folder list.

**Shared Folder List**

Create Delete Delete Recycle Bin Filter:

	Name	Description	Drive/Array / Available Capacity	Quota	Snapshot	Access Restrictions
	<a href="#">usbdisk1</a>	USB Drive 1	USB Drive 1 / 0.4 GB	- GB	—	—
<input checked="" type="checkbox"/>	<a href="#">share</a>		Array 1 / 16667.5 GB	- GB	<u>1</u>	—

Page 1 of 1 1-2 of 2 Items per page: 20

Select All on This Page Select All Including Another Page Deselect All

Advanced Settings for Subfolders Close

**4** Select the checkbox for the target snapshot and then click *Restore*.

**Snapshot List: share**

Schedule Snapshot: Disabled  
Auto Archive: Arrange by timeline

Create Edit Delete Restore Copy Date Range:  ~

	Locked	Date Created	Creator	Description
<input checked="" type="checkbox"/>	✓	<a href="#">2022-10-04T13:33:10+09:00</a>	admin@TS5420D665	

Page 1 of 1 All 1 items are selected. 1-1 of 1 Items per page: 20

Select All on This Page Select All Including Another Page Deselect All

Advanced Settings Close

- 5** A new snapshot will be created before restoring the snapshot. Select or clear the “Lock” checkbox to determine whether the created snapshot will be locked or unlocked and enter a short description, then click *OK*. A locked snapshot cannot be deleted due to auto-archiving.

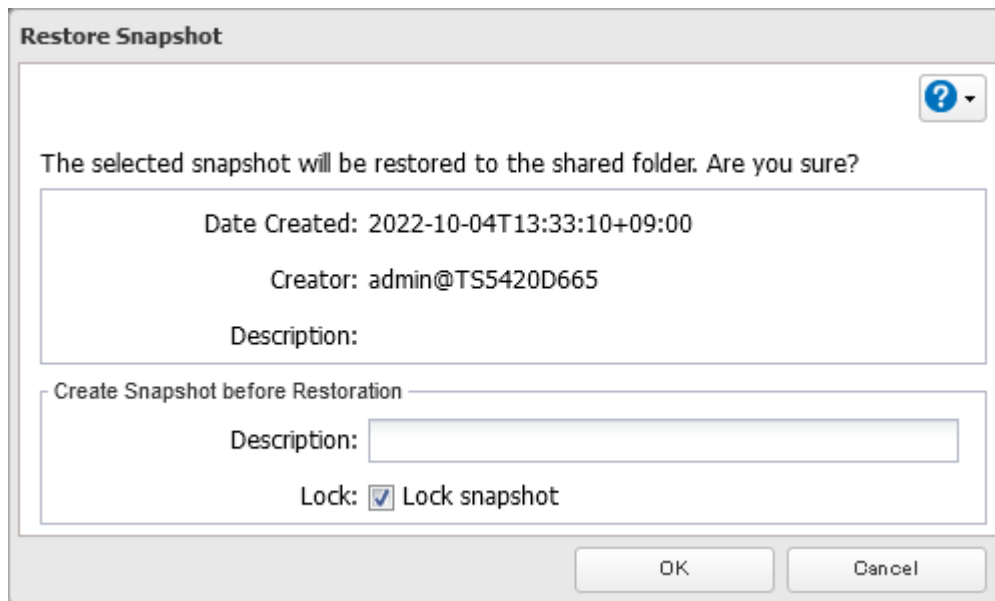

- 6** The process is complete once you close the confirmation window that appears.

## For iSCSI Volumes

**Note:** When restoring snapshots, the iSCSI service will restart so iSCSI volumes will become unable to connect temporarily. If you have saved the virtual machine to the iSCSI volume, shut down the virtual machine before restoring.

- 1** From Settings, click *Storage*.



- 2** Click the settings icon (  ) to the right of “iSCSI”.



**3** Select the checkbox for the target iSCSI volume and click *Show Snapshot List*.

The screenshot shows the 'iSCSI Settings' window with the 'Internet Storage Name Service (iSNS)' tab selected. The 'Show Snapshot List' button is visible. Below the buttons is a table with the following data:

Status	Volume Name	Backstore	Drive/Array	Target Name	Authentication	Capacity
<input checked="" type="checkbox"/>	Standing By <a href="#">volume01</a>	File I/O	Array 1	iqn.2004-08.jp.buffalo.cce1d5e72008.volume01	-	10 GB

At the bottom of the window, there is a pagination control showing 'Page 1 of 1', 'All 1 items are selected.', '1-1 of 1', and 'Items per page: 20'. There are also buttons for 'Select All on This Page', 'Select All Including Another Page', and 'Deselect All'.

**4** Select the checkbox for the target snapshot and then click *Restore*.

The screenshot shows the 'Snapshot List: volume01' window. At the top, it indicates 'Schedule Snapshot: Disabled' and 'Auto Archive: Arrange by timeline'. Below this are buttons for 'Create', 'Edit', 'Delete', and 'Restore', along with a 'Date Range' selector. The main area contains a table with the following data:

Locked	Date Created	Creator	Description	Consisten
<input checked="" type="checkbox"/>	2022-10-04T13:30:35+09:00	admin@TS5420D665		Crash...

At the bottom of the window, there is a pagination control showing 'Page 1 of 1', '1-1 of 1', and 'Items per page: 20'. There are also buttons for 'Select All on This Page', 'Select All Including Another Page', and 'Deselect All'.

- 5** A new snapshot will be created before restoring the snapshot. Select or clear the “Lock” checkbox to determine whether the created snapshot will be locked or unlocked and enter a short description, then click *OK*. A locked snapshot cannot be deleted due to auto-archiving.

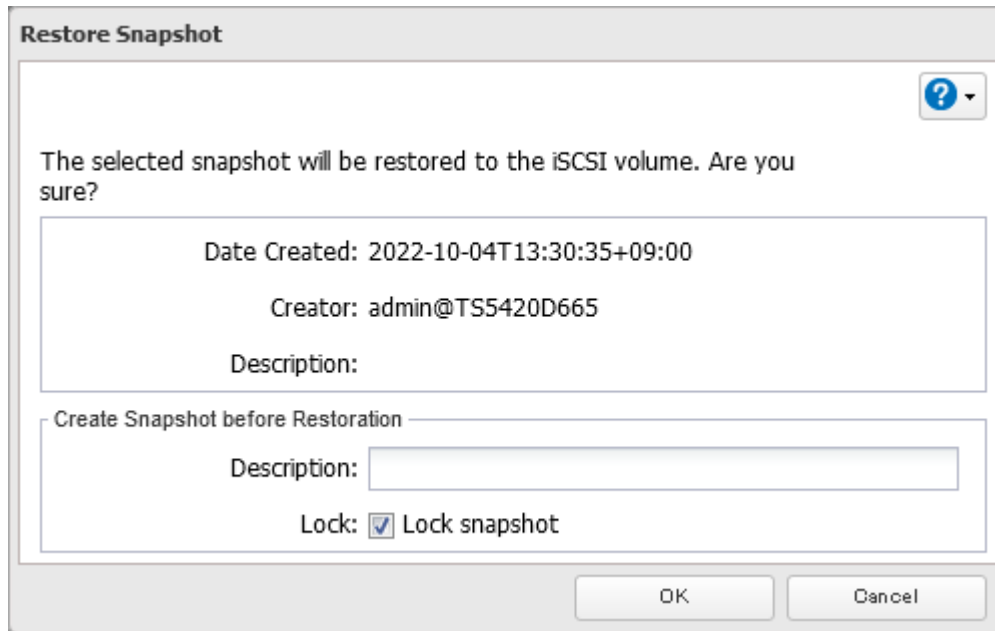

- 6** The process is complete once you close the confirmation window that appears.

If you have saved the virtual machine to the iSCSI volume and you are using Snapshot Agent for TeraStation, next restore the snapshot of the virtual machine using vCenter Server’s management console.

## Configuring Schedule Snapshot

If you want to create a snapshot for the purpose of regular backups, follow the procedure below.

### For Shared Folders

- 1** From Settings, click *File Sharing*.



- 2** Click the settings icon (  ) to the right of “Folder Setup”.



**3** Click the number under “Snapshot” for the shared folder on the shared folder list.

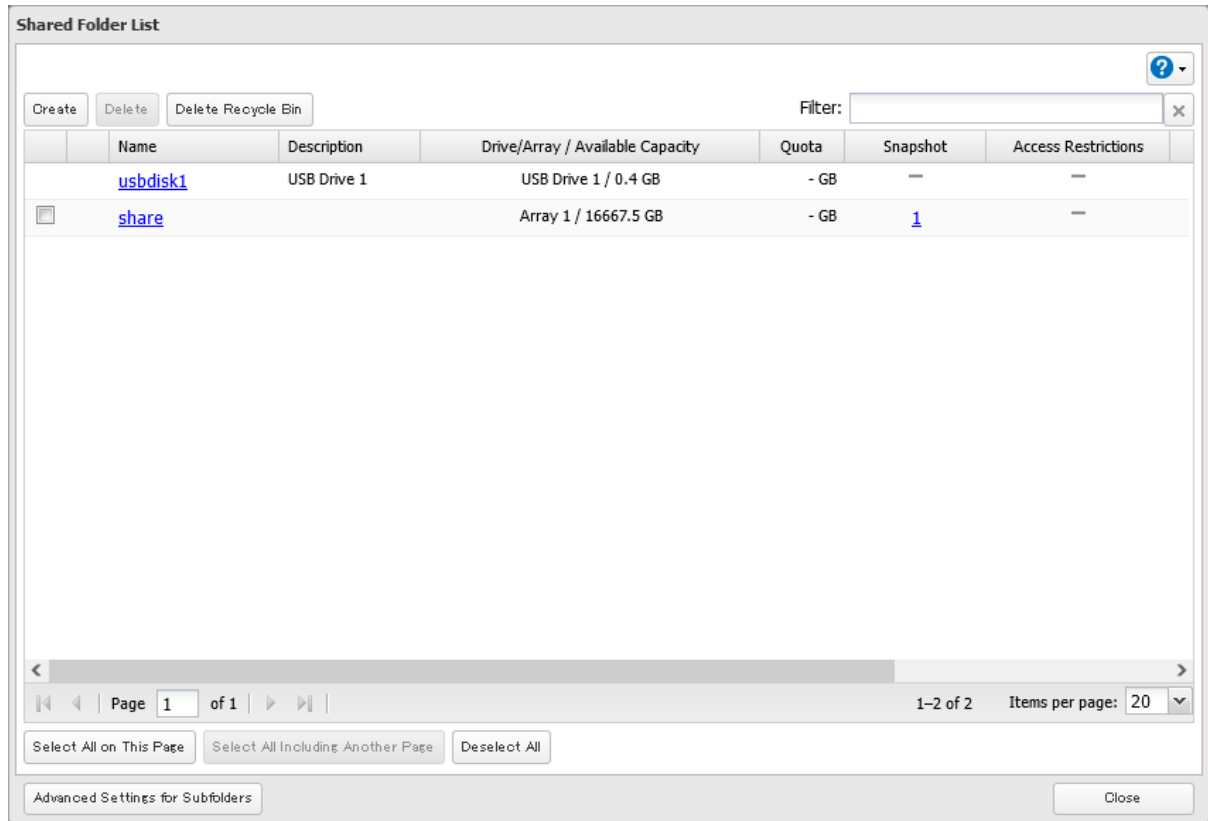

**4** Click *Advanced Settings* at the lower-left corner of the window.

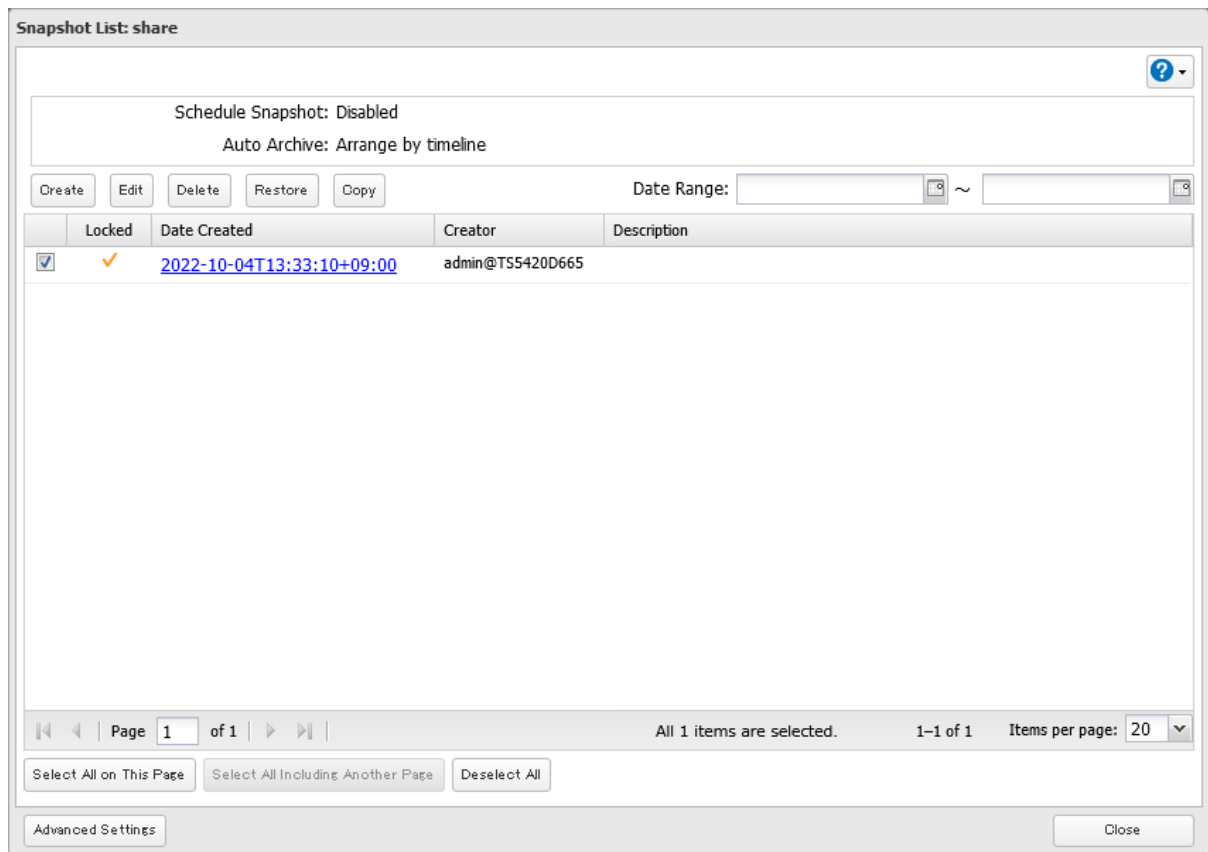

**5** Click the *Schedule* tab.

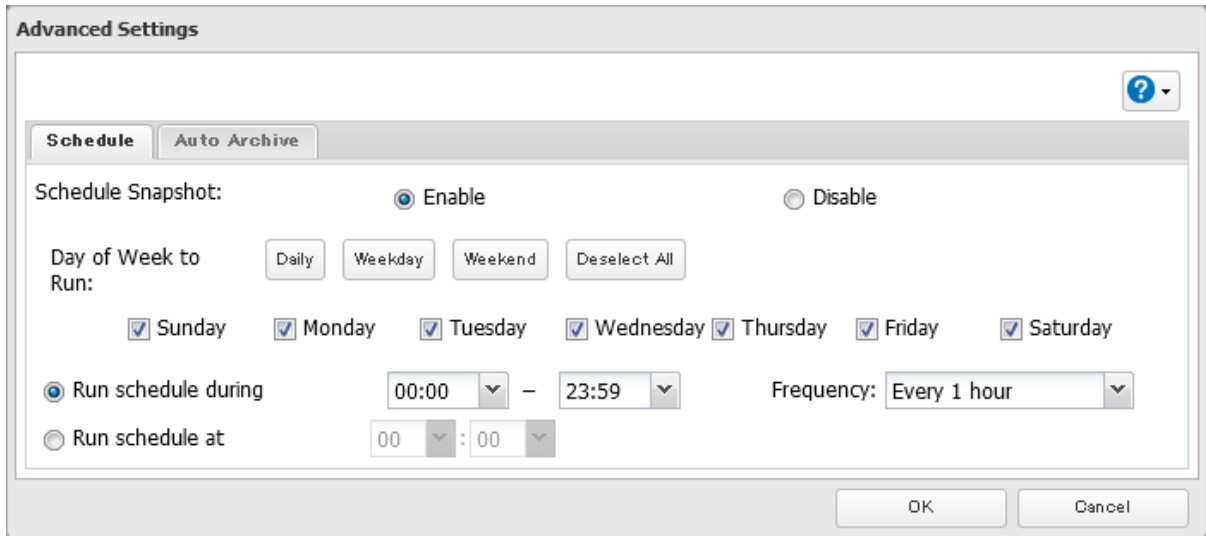

**6** Enable “Schedule Snapshot”.

**7** Select the day of the week and time for when to have a snapshot automatically created, then click *OK*.

**8** The process is complete once you close the confirmation window that appears.

## For iSCSI Volumes

**1** From Settings, click *Storage*.



**2** Click the settings icon (  ) to the right of “iSCSI”.



**3** Select the checkbox for the target iSCSI volume and click *Show Snapshot List*.

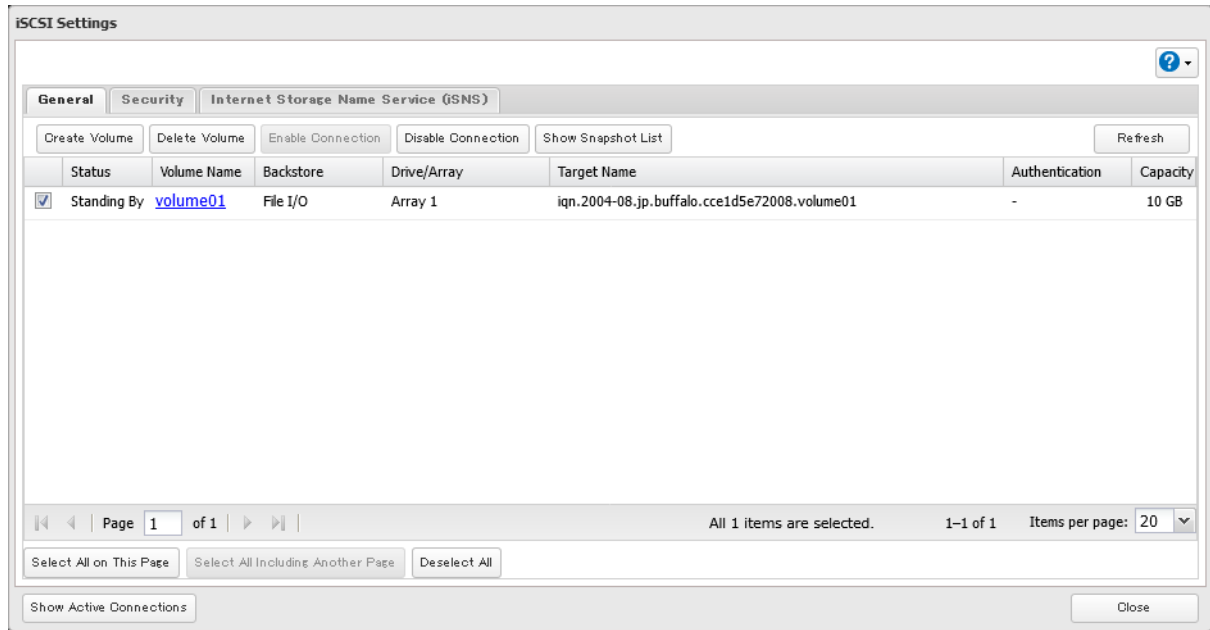

**4** Click *Advanced Settings* at the lower-left corner of the window.

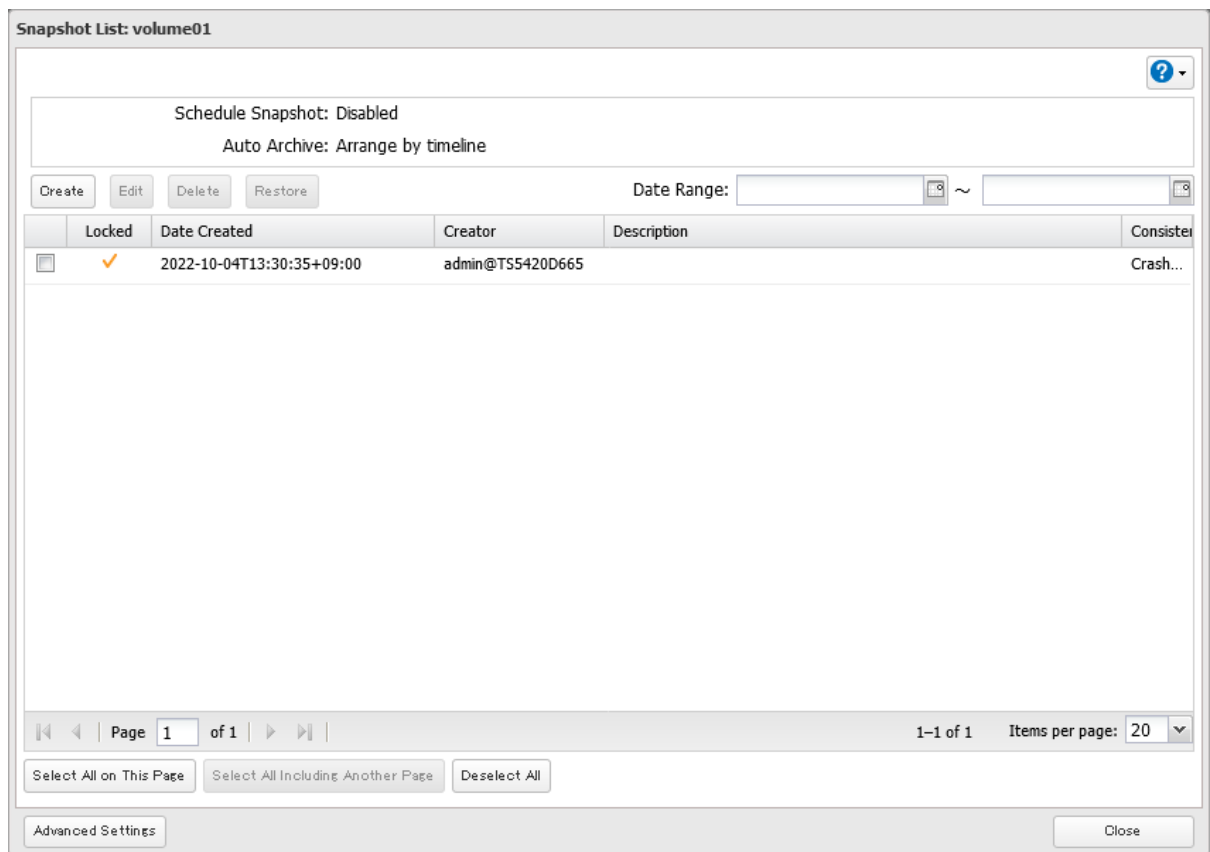

**5** Click the *Schedule* tab.

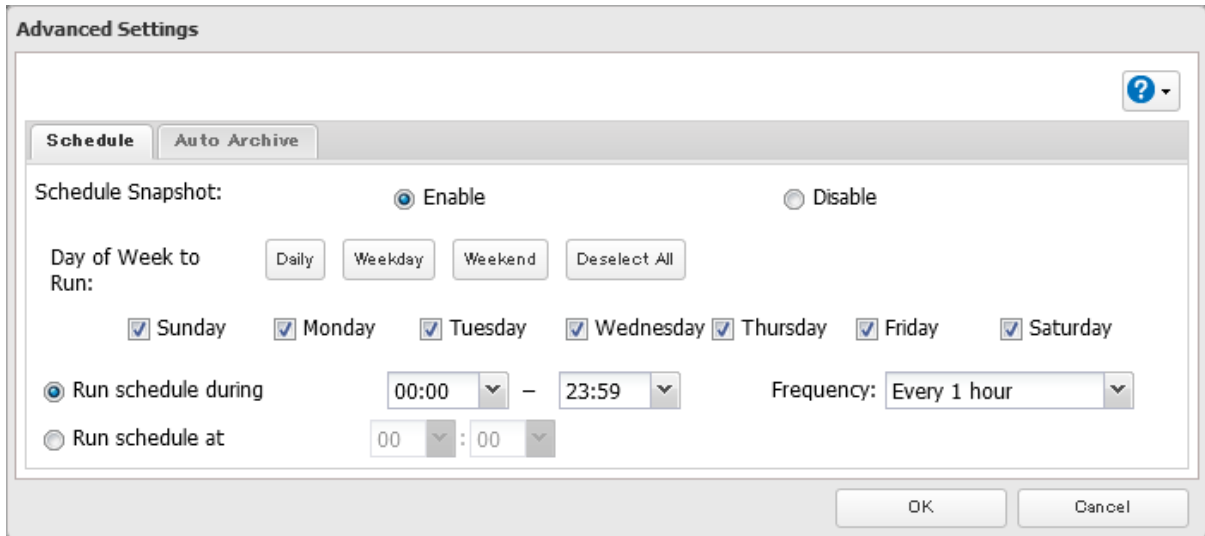

**6** Enable “Schedule Snapshot”.

**7** Select the day of the week and time when to automatically create a snapshot, then click *OK*.

**8** The process is complete once you close the confirmation window that appears.

## Configuring Snapshot Archive Settings

If you regularly create snapshots, it will use up capacity on the TeraStation. Snapshot archive settings will allow you to save capacity on created snapshots by automatically deleting older snapshots. You can set either a version-based or a timeline-based rule to delete snapshots.

**Note:** The locked snapshots will be kept even if archive settings are in effect.

### For Shared Folders

**1** From Settings, click *File Sharing*.



**2** Click the settings icon (  ) to the right of “Folder Setup”.



**3** Click the number under “Snapshot” for the shared folder on the shared folder list.

**Shared Folder List**

Create Delete Delete Recycle Bin Filter:

	Name	Description	Drive/Array / Available Capacity	Quota	Snapshot	Access Restrictions
	<a href="#">usbdisk1</a>	USB Drive 1	USB Drive 1 / 0.4 GB	- GB	—	—
<input checked="" type="checkbox"/>	<a href="#">share</a>		Array 1 / 16667.5 GB	- GB	<u>1</u>	—

Page 1 of 1 1-2 of 2 Items per page: 20

Select All on This Page Select All Including Another Page Deselect All

Advanced Settings for Subfolders Close

**4** Click *Advanced Settings* at the lower-left corner of the window.

**Snapshot List: share**

Schedule Snapshot: Disabled  
Auto Archive: Arrange by timeline

Create Edit Delete Restore Copy Date Range:  ~

	Locked	Date Created	Creator	Description
<input checked="" type="checkbox"/>	✓	<a href="#">2022-10-04T13:33:10+09:00</a>	admin@TS5420D665	

Page 1 of 1 All 1 items are selected. 1-1 of 1 Items per page: 20

Select All on This Page Select All Including Another Page Deselect All

Advanced Settings Close

## 5 Click the *Auto Archive* tab.

**Advanced Settings**

**Schedule** | **Auto Archive**

Schedule Snapshot:  Enable  Disable

Day of Week to Run:

Sunday  Monday  Tuesday  Wednesday  Thursday  Friday  Saturday

Run schedule during  –  Frequency:

Run schedule at  :

## 6 Select the rule to keep the snapshots and click *OK*. For more detailed information on archiving snapshots, refer to the [“Archive Rules for Snapshots”](#) section below.

**Advanced Settings**

**Schedule** | **Auto Archive**

Disable

Keep snapshot based on versions

Keep for  versions

Keep at least for  days

Keep snapshot based on timeline

Keep one snapshot per hour for  hours

Keep one snapshot per day for  days

Keep one snapshot per week for  weeks

Keep one snapshot per month for  months

Keep one snapshot per year for  years

- 7** Select either *Yes* or *No* to apply the new snapshot archive settings to the existing snapshots.

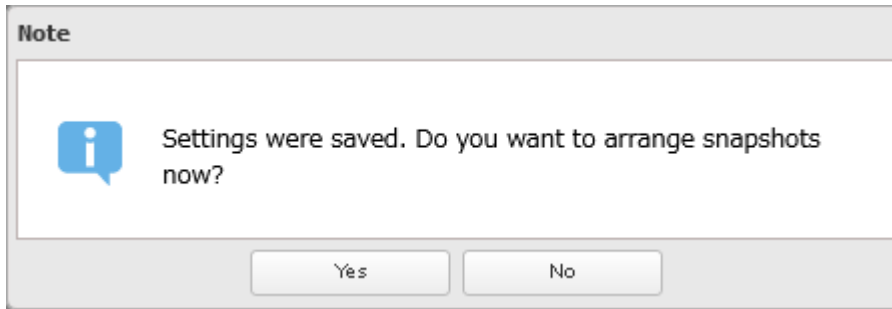

- 8** The process is complete once you close the confirmation window that appears.

## For iSCSI Volumes

- 1** From Settings, click *Storage*.



- 2** Click the settings icon (  ) to the right of "iSCSI".



- 3** Select the checkbox for the target iSCSI volume and click *Show Snapshot List*.

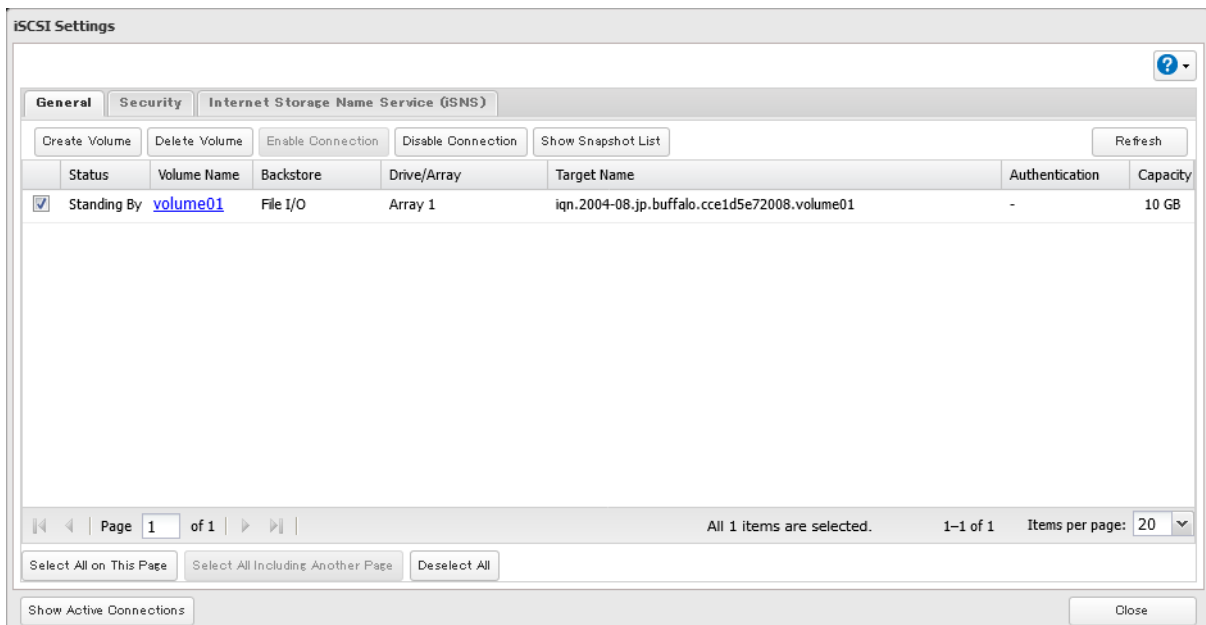

4 Click *Advanced Settings* at the lower-left corner of the window.

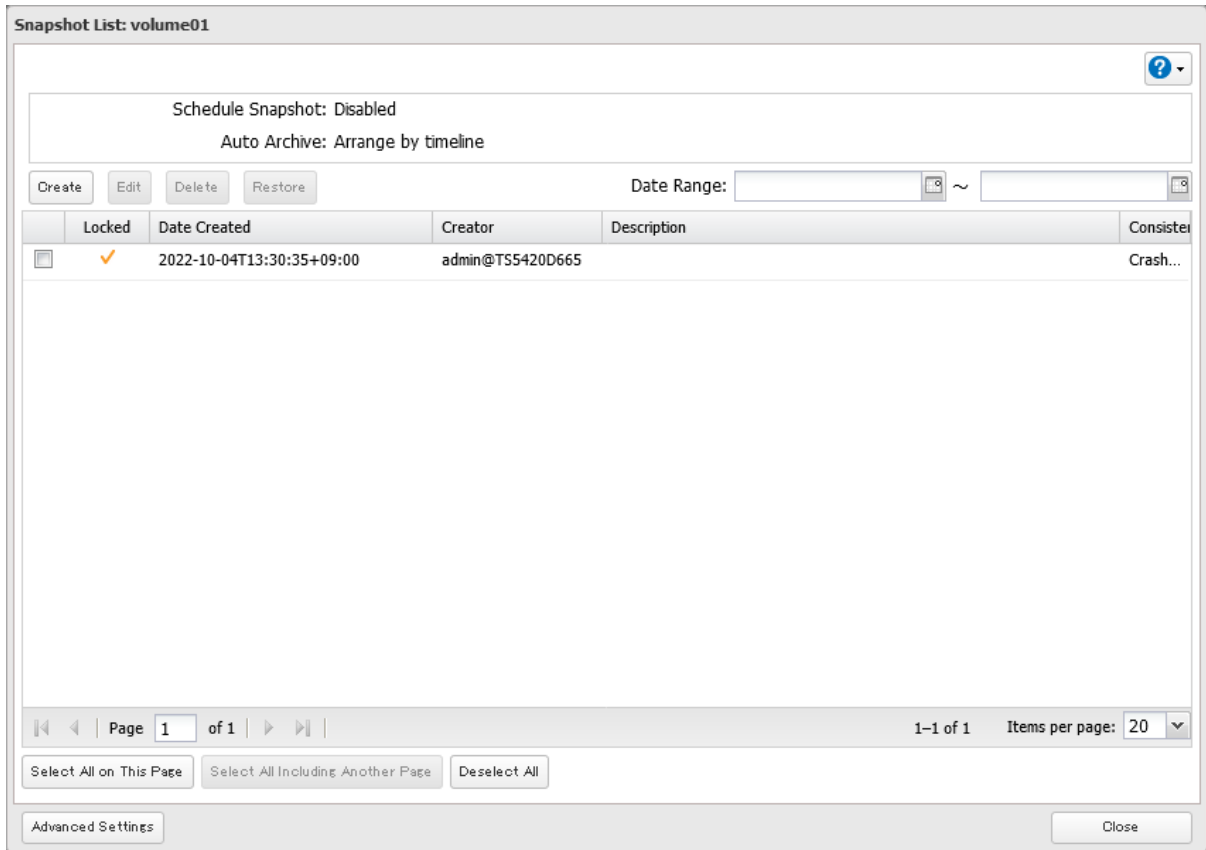

5 Click the *Auto Archive* tab.

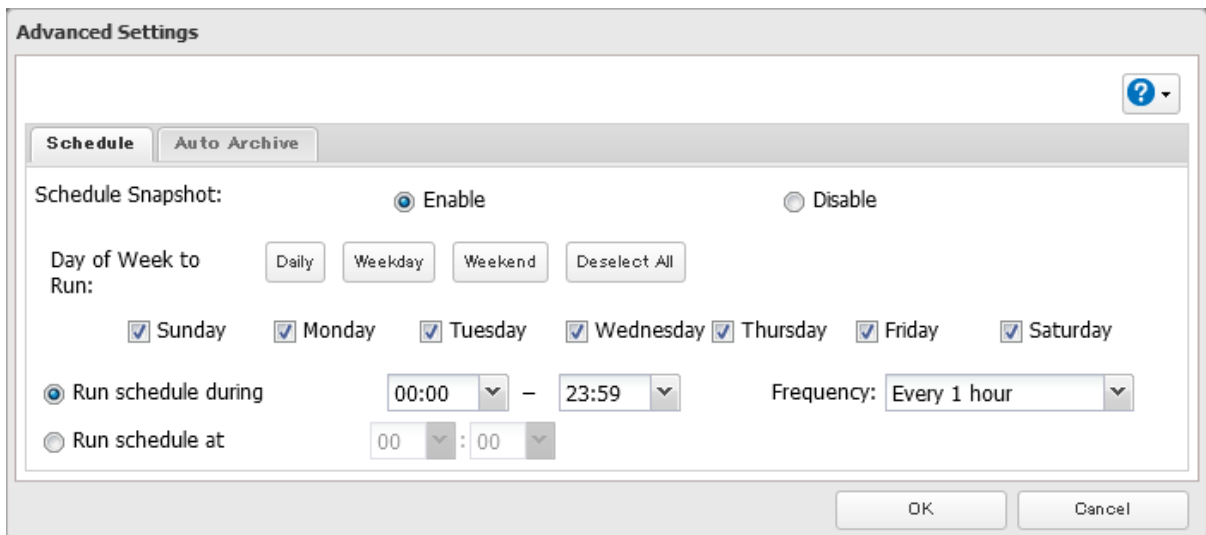

- 6** Select the rule to keep the snapshots and click *OK*. For more detailed information on archiving snapshots, refer to the [“Archive Rules for Snapshots”](#) section below.

**Advanced Settings**

**Schedule** **Auto Archive**

Disable

Keep snapshot based on versions

Keep for 168 versions

Keep at least for 0 days

Keep snapshot based on timeline

Keep one snapshot per hour for 24 hours

Keep one snapshot per day for 7 days

Keep one snapshot per week for 5 weeks

Keep one snapshot per month for 6 months

Keep one snapshot per year for 0 years

OK Cancel

- 7** Select either *Yes* or *No* to apply the new snapshot archive settings to the existing snapshots.

**Note**

Settings were saved. Do you want to arrange snapshots now?

Yes No

- 8** The process is complete once you close the confirmation window that appears.

## Archive Rules for Snapshots

### Version-Based











If you enter specific versions, the snapshots created from the latest up to the entered versions will be kept. Snapshots that don't match the version will not be removed. There is an option to exclude from the target versions until a set number of days has passed. If you set this option and the specified days haven't passed yet, the snapshots will be kept even if they match the target versions to be deleted.

### Timeline-Based

This rule uses a timeline of when the snapshot was created to keep snapshots. Using this rule will keep any snapshots created at closest to 0 minutes on the hour and 12:00 a.m. (midnight) on the day.

The following example illustrates a scenario of when a snapshot is regularly created during 12:00 a.m. to 11:00 p.m. for every hour everyday and the default archive rule is used, for 24 hours, 7 days, 5 weeks, 6 months, and 0 years.

**Current time:** 31st, 11:59 p.m.

	Mon	Tue	Wed	Thu	Fri	Sat	Sun
1st	1  12:00 a.m.	2	3	4	5	6	7
2nd	8  12:00 a.m.	9	10	11	12	13	14
3rd	15  12:00 a.m.	16	17	18	19	20	21
4th	22  12:00 a.m.	23	24	25  12:00 a.m.	26  12:00 a.m.	27  12:00 a.m.	28  12:00 a.m.
5th	29  12:00 a.m.	30  12:00 a.m.	31  12:00 a.m.				

Snapshots created every hour between 12:00 a.m. to 11:00 p.m. today are kept by matching the hour-based rule. One snapshot per day is also kept for the last seven days by matching the day-based rule. One snapshot on every Monday is also kept for the last five weeks by matching the week-based rule. One snapshot on every first day of the month is also kept for six months by matching the month-based rule. If you change the year-based rule from the default settings, one snapshot on January 1st will also be kept for the specified years.

## Backing Up Data on the TeraStation

You can back up the TeraStation folders to another shared folder on the same TeraStation, a connected USB drive, or a shared folder on another Buffalo NAS device, either on the same network or on another network. For best results, using a 10GbE port to connect a backup device is recommended.

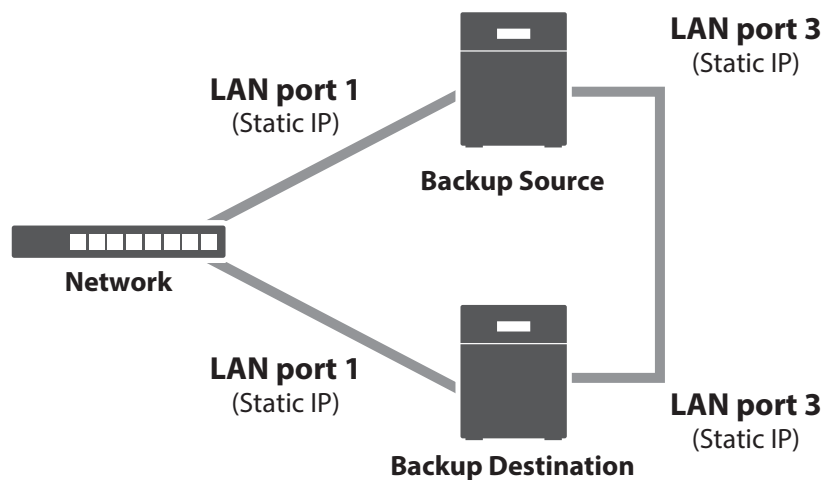

## Backup Modes

The following types of backup are available from this TeraStation. To restore data from backup, refer to the [“Restoring Backup Data”](#) section below.

### Full Backup

All files in the source will be backed up to the destination. You can specify how many backup versions to keep from 1–400, or select “Unlimited” to keep all backups until the drive is full. If you specify a number of backup versions, the backup destination folder should be on the same TeraStation or on an external USB drive attached to that TeraStation.

The backup data will be stored in the folder whose name will be the backup date and time.

- **Folders available as backup sources:**
  - Shared folder on the backup source TeraStation\*1
  - USB drive connected to the backup source TeraStation\*1
  - Shared folder on another Buffalo NAS device\*2
  - Shared folder on another rsync-compatible device
- **Folders available as backup destinations:**
  - Shared folder on the backup source TeraStation\*2
  - USB drive connected to the backup source TeraStation\*2, 3
  - Shared folder on another Buffalo NAS device\*2, 4
  - Shared folder on another rsync-compatible device

\*1 You can select up to the second level of folders. However, if the folder name of a second level folder contains symbols, that folder may not appear as the target folder.

\*2 The folder should have the “Backup” checkbox selected under “LAN Protocol Support” on the shared folder settings.

\*3 If the “Inherit subfolders’ access restrictions” option is selected when creating a backup job, use Btrfs, XFS, or ext3 file systems.

\*4 If the “Inherit subfolders’ access restrictions” option is selected when creating a backup job, the device should be a Buffalo NAS device whose subfolders’ access restrictions is available.

### Overwrite (Incremental)

The first backup job runs like a full backup. As each subsequent backup job runs, only files that have been changed since the last full backup will be backed up, but any files deleted from the backup source folder will also remain in the backup destination folder. The folder structure in the backup destination folder will be the same as the backup source folder.

- **Folders available as backup sources:**
  - Shared folder on the backup source TeraStation\*1

- USB drive connected to the backup source TeraStation\*1
- Shared folder on another Buffalo NAS device\*2
- Shared folder on another rsync-compatible device
- **Folders available as backup destinations:**
  - Shared folder on the backup source TeraStation\*2
  - USB drive connected to the backup source TeraStation\*2, 3
  - Shared folder on another Buffalo NAS device\*2, 4
  - Shared folder on another rsync-compatible device

\*1 You can select up to the second level of folders. However, if the folder name of a second level folder contains symbols, that folder may not appear as the target folder.

\*2 The folder should have the “Backup” checkbox selected under “LAN Protocol Support” on the shared folder settings.

\*3 If the “Inherit subfolders' access restrictions” option is selected when creating a backup job, use Btrfs, XFS, or ext3 file systems.

\*4 If the “Inherit subfolders' access restrictions” option is selected when creating a backup job, the device should be a Buffalo NAS device whose subfolders' access restrictions is available.

## Overwrite (Differential)

The first backup job runs like a full backup. As each subsequent backup job runs, only files that have been changed since the last full backup will be backed up, and any files deleted from the backup source folder will also be deleted from the backup destination folder. The backup destination folder will always remain the same size as the backup source folder, and the folder structure in the backup destination folder will be the same as the backup source folder.

- **Folders available as backup sources:**
  - Shared folder on the backup source TeraStation\*1
  - USB drive connected to the backup source TeraStation\*1
  - Shared folder on another Buffalo NAS device\*2
  - Shared folder on another rsync-compatible device
- **Folders available as backup destinations:**
  - Shared folder on the backup source TeraStation\*2
  - USB drive connected to the backup source TeraStation\*2, 3
  - Shared folder on another Buffalo NAS device\*2, 4
  - Shared folder on another rsync-compatible device

\*1 You can select up to the second level of folders. However, if the folder name of a second level folder contains symbols, that folder may not appear as the target folder.

\*2 The folder should have the “Backup” checkbox selected under “LAN Protocol Support” on the shared folder settings.

\*3 If the “Inherit subfolders' access restrictions” option is selected when creating a backup job, use Btrfs, XFS, or ext3 file systems.

\*4 If the “Inherit subfolders' access restrictions” option is selected when creating a backup job, the device should be a Buffalo NAS device whose subfolders' access restrictions is available.

## Management Backup

Each time a backup is executed, management information is stored, and only files that have changed are backed up. Data is retrieved from the previous backup file for files that were not changed, which can help reduce the space used for backup and also for referencing status at a particular point in time (for data snapshot applications). You can specify how many backup versions to keep from 1–400, or select “Unlimited” to keep all backups until the drive is full. If using an external USB drive as the backup destination, do not use folders from drives formatted with FAT. The backup data will be stored in the folder whose name will be the backup date and time, and the destination folder will be set to read-only.

- **Folders available as backup sources:**
  - Shared folder on the backup source TeraStation\*1
  - USB drive connected to the backup source TeraStation\*1

- Shared folder on another Buffalo NAS device\*2
- Shared folder on another rsync-compatible device
- **Folders available as backup destinations:**
  - Shared folder on the backup source TeraStation\*2
  - USB drive connected to the backup source TeraStation\*2, 3, 4

\*1 You can select up to the second level of folders. However, if the folder name of a second level folder contains symbols, that folder may not appear as the target folder.

\*2 The folder should have the “Backup” checkbox selected under “LAN Protocol Support” on the shared folder settings.

\*3 If the “Inherit subfolders' access restrictions” option is selected when creating a backup job, use Btrfs, XFS, or ext3 file systems.

\*4 The compatible file systems are ext3, XFS, Btrfs, and NTFS.

**Note:** For the destination folder, do not use a folder that has already been used as a target folder for another backup job. If you wish to use a folder that currently contains backup data as the destination folder for another backup job, format the folder first, or delete all data in the destination folder and change the folder attribute to read and write before configuring the folder as the destination folder.

## Snapshot Backup

Files and snapshots on the backup source will be backed up to the backup destination. Each backup job will create a snapshot before the job runs.

The first backup job runs like a full backup. As each subsequent backup job runs, only files that have been changed since the last backup will be backed up, and any files deleted from the backup source folder will also be deleted from the backup destination folder. The folder structure in the backup destination folder will be the same as the backup source folder.

- **Folders available as backup sources:**
  - Shared folder on the backup source TeraStation\*
  - Shared folder on another Buffalo NAS device\*, \*\*
- **Folders available as backup destinations:**
  - Shared folder on the backup source TeraStation\*, \*\*
  - Shared folder on another Buffalo NAS device\*, \*\*, \*\*\*

\*The folders should be created on a Btrfs-formatted area.

\*\*The folder should have the “Backup” checkbox selected under “LAN Protocol Support” on the shared folder settings.

\*\*\*If the “Inherit subfolders' access restrictions” option is selected when creating a backup job, the device should be a Buffalo NAS device whose subfolders' access restrictions is available.

### Notes:

- The number of snapshots kept after backing up to the backup destination will vary depending on the auto-archive settings. If the backup snapshot versions are later than the versions on the backup destination, they will overwrite the earlier snapshot versions.
- If you want to see the history of snapshots on the backup destination folder, use shadow copy or click *Restore* in Settings. Refer to the [“Snapshots”](#) section above.

## iSCSI Backup

Imaged iSCSI volume data will be backed up. Each backup job will create a snapshot before the job runs. The backup source and backup destination can be paired and configured together. Backing up an iSCSI volume will create a “fileio” file in the backup destination shared folder.

The first backup job runs like a full backup. As each subsequent backup job runs, only files that have been changed since the last full backup will be backed up, and any files deleted from the backup source folder will also be deleted from the backup destination folder.

- **Folders available as backup sources:**
  - Shared folder on the backup source TeraStation\*

- Shared folder on another Buffalo NAS device\*, \*\*
- The iSCSI file I/O volume on the backup source TeraStation\*
- **Folders available as backup destinations:**
  - Shared folder on the backup source TeraStation\*, \*\*
  - Shared folder on another Buffalo NAS device\*, \*\*, \*\*\*
  - The iSCSI file I/O volume on the backup source TeraStation\*

\*The folders should be created on a Btrfs-formatted area.

\*\*The folder should have the “Backup” checkbox selected under “LAN Protocol Support” on the shared folder settings.

\*\*\*If the “Inherit subfolders' access restrictions” option is selected when creating a backup job, the device should be a Buffalo NAS device whose subfolders' access restrictions is available.

**Notes:**

- The number of snapshots kept after backing up to the backup destination will vary depending on the auto-archive settings. If the backup snapshot versions are later than the versions on the backup destination, they will overwrite the earlier snapshot versions.
- If you select a shared folder as a backup source, only an iSCSI volume can be selected as a backup destination and vice versa. The same type of folders cannot be used in an iSCSI backup job.

## Preparing a Backup Destination

Configure a shared folder on a Buffalo NAS device or connected USB drive as a backup destination. The following procedure explains using another shared folder on the TeraStation as a backup destination. The procedure may vary depending on which Buffalo NAS device is selected as a destination. If using a USB drive as a backup destination, make sure its attribute is set to read and write. To change a read-only USB drive's attribute to read and write, refer to the [“Read-Only Shares”](#) section in chapter 3.

If you would like to back up data from multiple backup sources, we recommend not using the same backup destination, as data in the backup destination may be overwritten by subsequent backup jobs. If you must back up data from multiple backup sources to the same backup destination, using management backup is recommended for precise version control.

**Note:** If you want to set this TeraStation as the backup destination for an rsync-compatible device, refer to the [“If Backing Up from rsync-Compatible Devices to the TeraStation”](#) section instead of following the procedure below.

- 1 From Settings, click *File Sharing*.

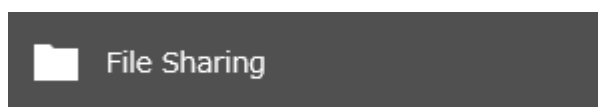

- 2 Click the settings icon (  ) to the right of “Folder Setup”.



### 3 Choose the folder to be set as a backup destination.

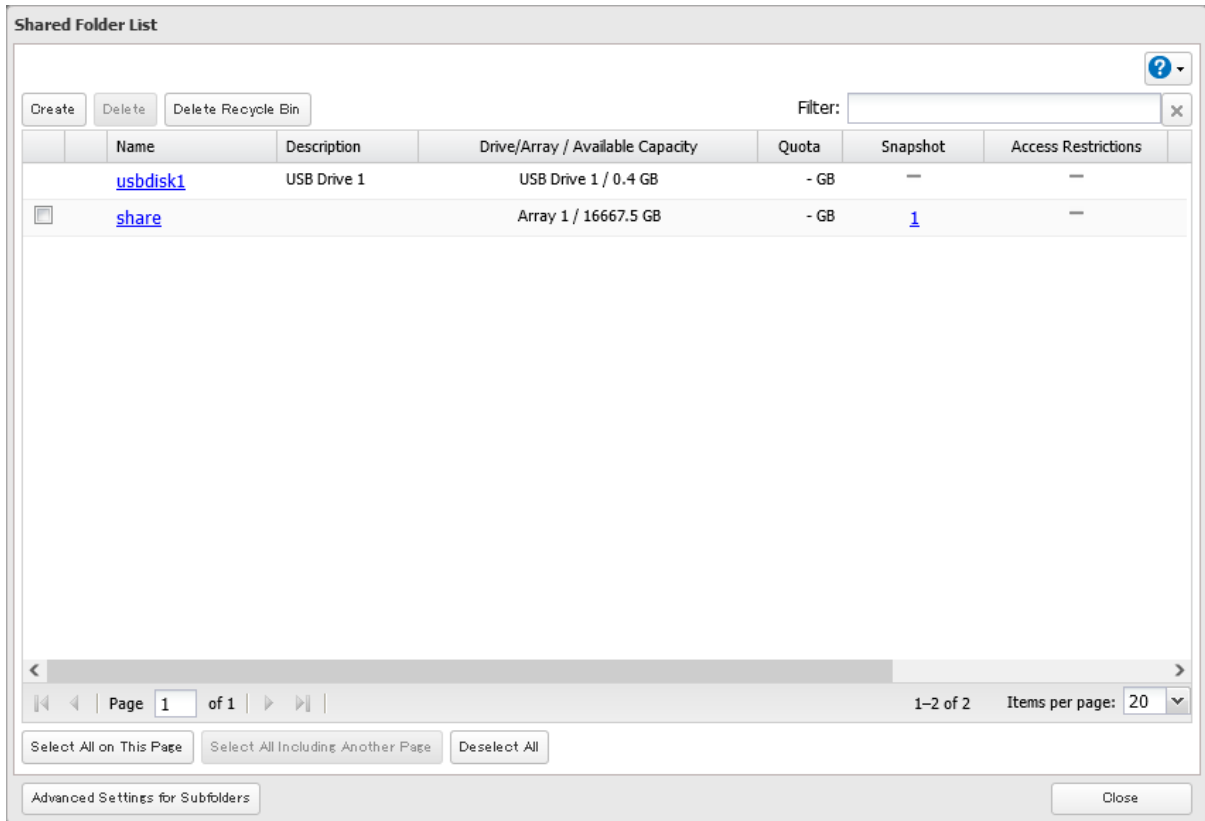

### 4 Under "LAN Protocol Support", select the "Backup" checkbox on the *Basic* tab.

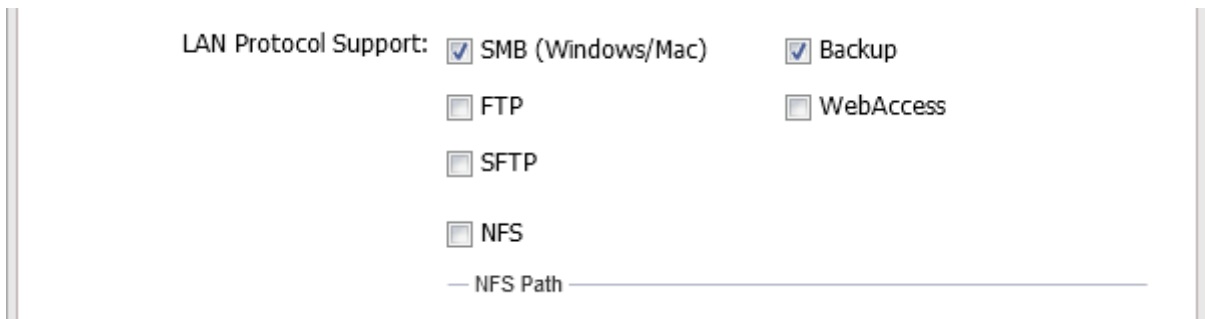

### 5 Click *OK* and proceed to the next step to create a backup device access key.

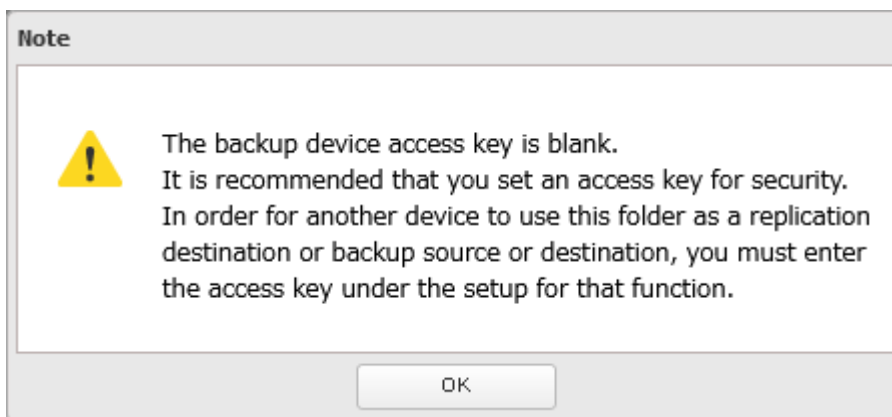

**6** Enter the desired characters into the backup device access key field and click *OK*.

Backup Device Access Key:

**Note:** You may leave this field blank if you do not want a backup device access key, but for security reasons we highly recommend entering one for the shared folder. If a backup device access key is configured for the shared folder, that folder will not show up as a target for the backup source or destination when configuring a backup job on another Buffalo NAS device unless it's entered. You may create multiple folders using different backup device access keys for backup and replication, but only one access key can be used on the TeraStation. Folders that are configured with a different access key cannot be used.

**7** The process is complete once you close the confirmation window that appears.

#### Notes:

- If you want to back up to a Buffalo NAS device on another network, follow the procedure below to add the Buffalo NAS device so it can be used as a backup destination.
  - (1) Create a new backup job by referring to the [“Configuring a Backup Job”](#) section below.
  - (2) On the screen that allows you to select a shared folder, click *List of Servers*.
  - (3) Click *Add*; select the “Add Buffalo NAS device” option, enter the IP address or hostname of the destination Buffalo NAS device, then click *OK*.
  - (4) Click *Close*.
  - (5) Click *Refresh* and make sure the desired Buffalo NAS device has been added to the list.
- If you want to back up to an rsync-compatible device, follow the procedure below to add the rsync-compatible device so it can be used as a backup destination.
  - (1) Create a new backup job by referring to the [“Configuring a Backup Job”](#) section below.
  - (2) On the screen that allows you to select a shared folder, click *List of Servers*.
  - (3) Click *Add*; select the “Add rsync-compatible device” option, enter the IP address or hostname of the destination device, then click *OK*. If you want to encrypt the rsync access, enable “rsync Over SSH” and enter the rsync account settings.
  - (4) Click *Close*.
  - (5) Click *Refresh* and make sure the desired rsync-compatible device has been added to the list.
- Adding a target TeraStation’s IP address to the “List of Servers” and enabling rsync over SSH is required for snapshot and iSCSI backups, otherwise the target TeraStation will not appear as a backup destination.

## Configuring a Backup Job

You can configure backup jobs by using another shared folder on the Buffalo NAS device or a USB drive connected to the TeraStation as a destination. You can also back up to a Buffalo NAS device on another network as long as the two networks are connected by a VPN or the route is configured properly.

**1** From Settings, click *Backup*.



**2** Click the settings icon (  ) to the right of “Backup”.



- 3** If you had configured a backup device access key for the backup source folder on another Buffalo NAS device or the backup destination folder, click *Set*. If you hadn't, skip to step 5.

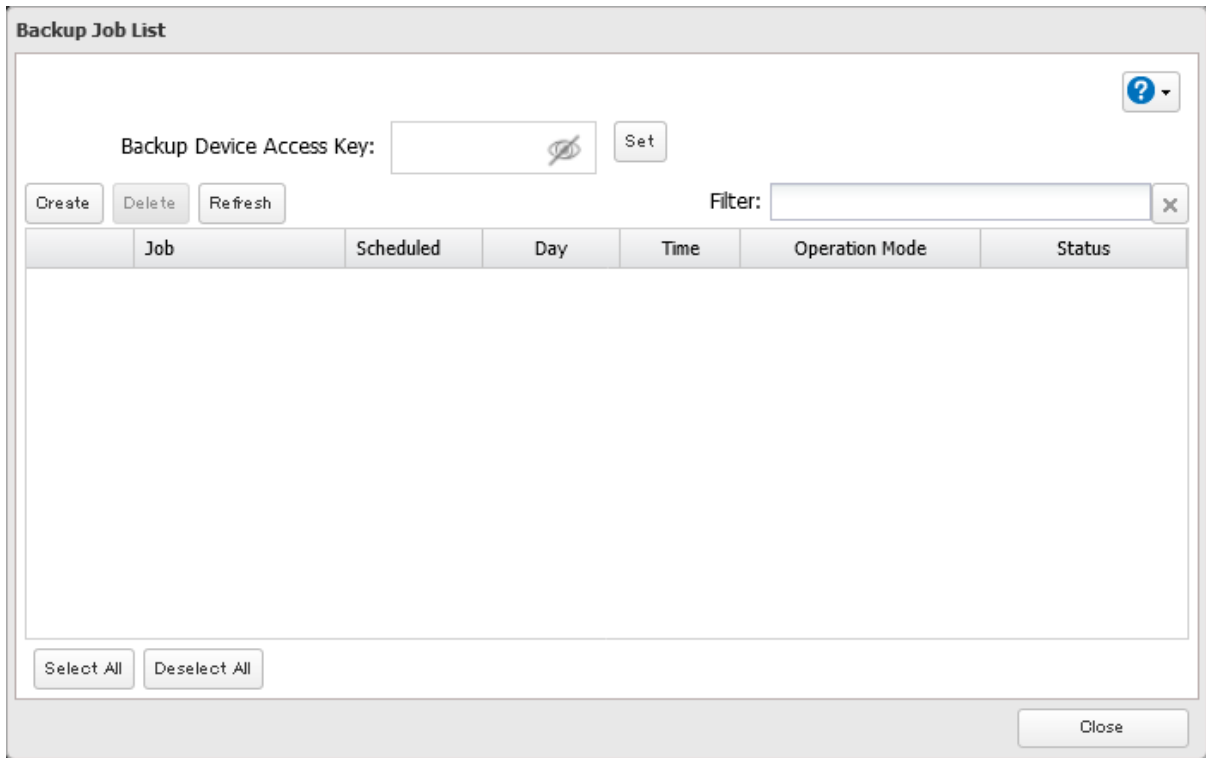

- 4** Enter the backup device access key and click *OK*.

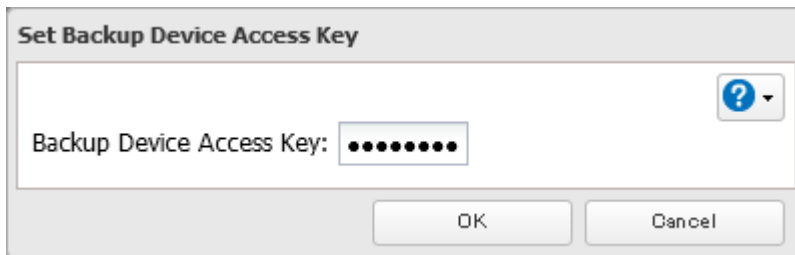

**5** Click *Create*.

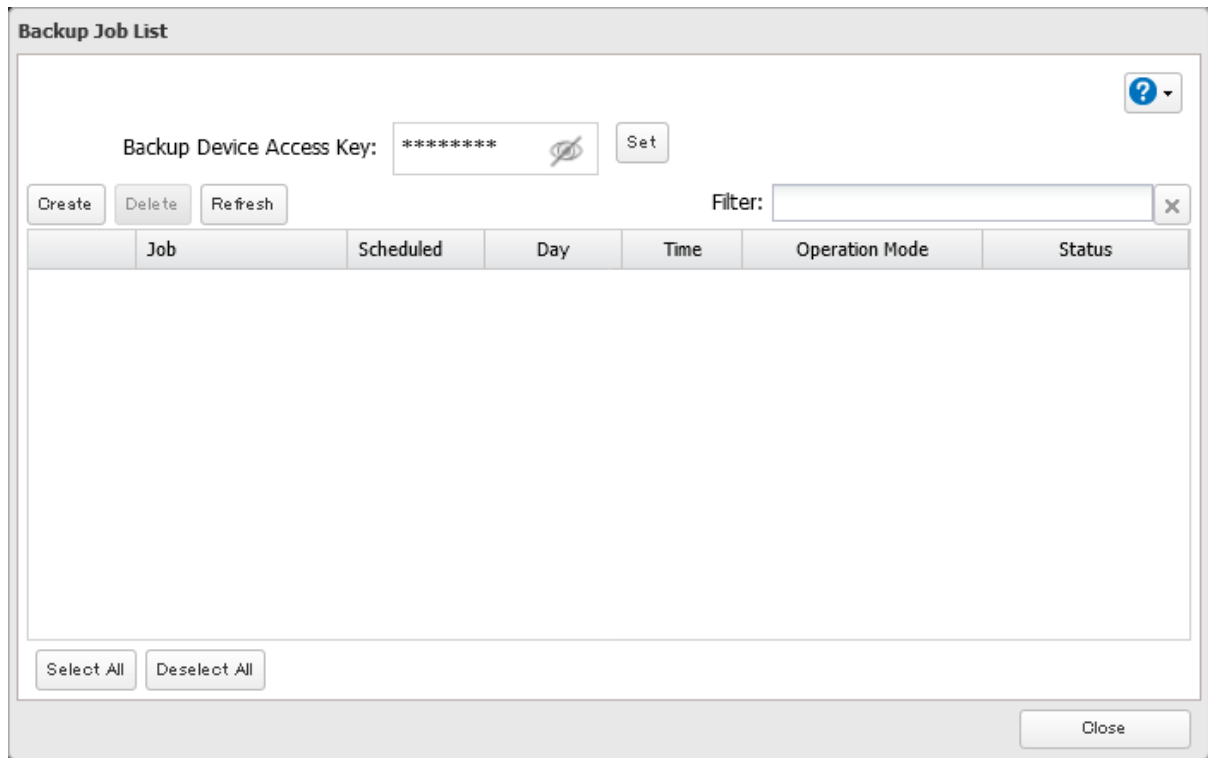

- 6** Select backup settings such as date and time to run, then select a backup mode for the “Operation Mode” drop-down list. Refer to the differences between the backup modes from the [“Backup Modes”](#) section above.

The screenshot shows the "Backup Job Settings" dialog box. At the top right, there is a red asterisk and the word "\*Required" next to a question mark icon. The "Job Name" field contains "job01". The "Schedule" is set to "Not scheduled", "Sunday", "00", and "00". The "Operation Mode" is set to "Full backup". The "Versions" are set to "10" with a checked "Unlimited" checkbox. Below these fields is an "Options" section with several checkboxes: "Create a subfolder for backup" (checked), "Create backup log file" (checked), "Save backup logs in the backup source folder" (selected with a radio button), "Select the folder to save backup logs" (unselected), "Target Folder:" with a "Browse" button, "Encrypted data transfer" (unchecked), "Compress and transfer" (unchecked), "Ignore backup errors and continue backup job on schedule" (checked), "Do not back up recycle bin" (unchecked), "Overwrite unchanged files" (unchecked), "Inherit subfolders' access restrictions" (unchecked), and "Back up all snapshots" (unchecked). At the bottom right, there are "OK" and "Cancel" buttons.

- 7** Click *Add*.

**8** Select the shared folders that will be the backup source and destination.

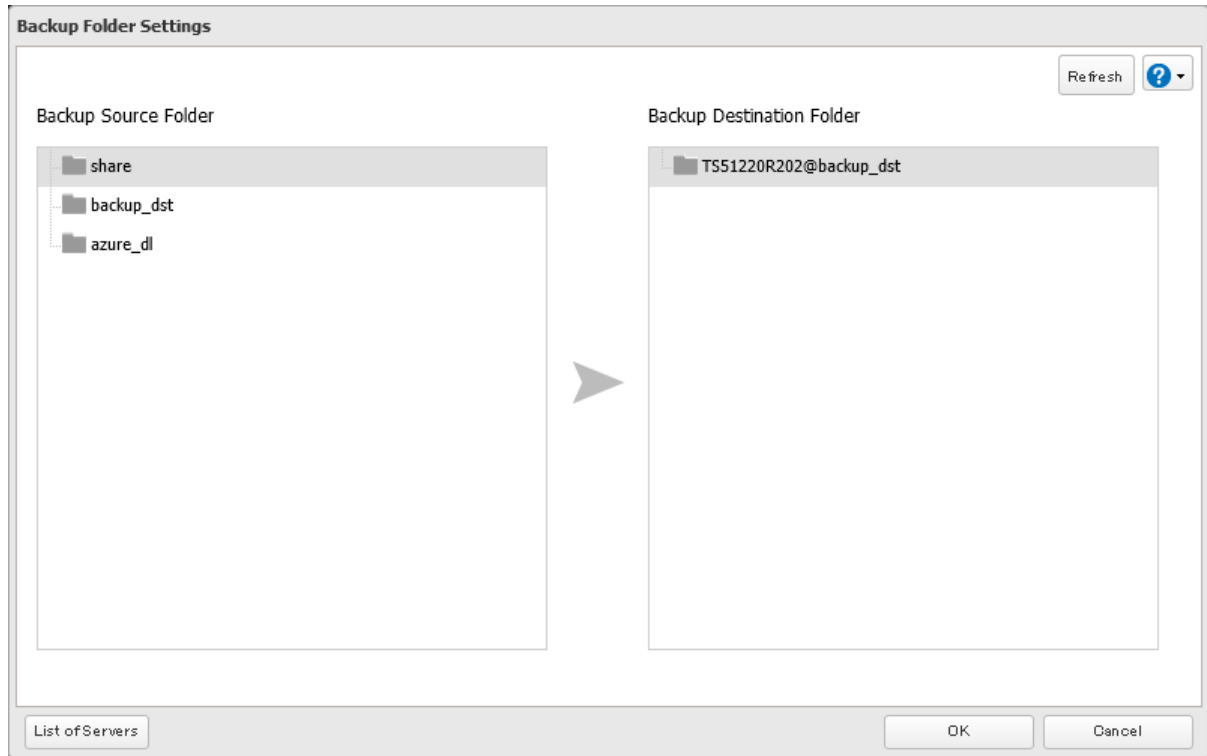

**9** Click *OK*, then click *OK* again.

**10** The process is complete once you close the confirmation window that appears. The backup job will be added to the backup jobs list.

**Notes:**

- Up to eight backup jobs can be configured at a time, and twenty-five backup source and destination folder pairs can be used in one backup job.
- During setup, you may choose to encrypt and/or compress backup data. Encrypted data will be transferred securely on the network. Compressed data will ease network loading and is recommended for slow or heavily-loaded network connections. Enabling either will increase the CPU load on the source TeraStation so that the transfer speed will become slower, and backup time will be slower than if they are disabled. Encrypted or compressed data will be decrypted or decompressed on the destination TeraStation.
- To inherit the subfolders' access restriction settings to the backup destination, the backup destination should also support the subfolders' access restrictions. Check it before creating a backup job.
- To back up data between Buffalo NAS devices on a network using jumbo frames, make sure that both devices are configured to use identical (or similar) MTU sizes. If MTU sizes are significantly different, the backup job may not be properly performed. In such a case, select the default MTU size (1,500 bytes) for both devices.
- You can also specify a hostname by a fully qualified domain name (FQDN).
- Windows-based TeraStations with multibyte characters in the hostname may not be detected as a backup destination, and folders in these devices cannot be used as backup destination folders.
- Backup data, such as ".DS\_Store" files, from macOS may include characters that cannot be read on FAT32-formatted drives in its filename. For best results, reformat the drive before using it as a backup destination.
- You can specify the LAN port to use for backup such as "(LAN3)". However, if you connect two or more LAN ports to the same network, the faster LAN port will take priority even if you specify the LAN port to be used. For example, if both LAN port 1 and LAN port 3 are connected to the same network and LAN port 3 is faster, then that port will be used even if you had configured LAN port 1 to be the port used for backups.

To use a slower LAN port for backup in this environment, configure the LAN port settings to a different network segment.

- If you also want to back up the subfolder's attributes (such as hidden files and read/write status) to the backup destination, select the "Inherit subfolders' access restrictions" option for backup options.

## If Backing Up from rsync-Compatible Devices to the TeraStation

If you want to set an rsync-compatible device as the backup source and back up data on the rsync-compatible device to the TeraStation, you will need to enable rsync access on the TeraStation.

- 1 From Settings, click *File Sharing*.

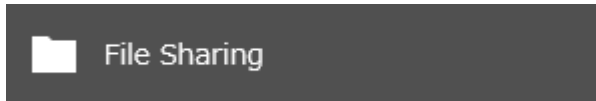

- 2 Click the settings icon (  ) to the right of "rsync".





- 3 Enter this TeraStation's admin password into the "Password" field and click OK.

 A dialog box titled "rsync Server Settings". It has two main sections: "rsync Accounts" and "SSH Settings".
 

- rsync Accounts:** Contains fields for "Username: admin", "Password \*:" (with a red asterisk and a help icon), and "Port Number: 873".
- SSH Settings:** Contains radio buttons for "rsync Over SSH: Enable" (selected) and "Disable", a "Port Number: 22" field, and "Authentication Method: Password authentication".

 At the bottom are "OK" and "Cancel" buttons.

**Note:** If you want to encrypt the rsync access, enable "rsync Over SSH".

- 4 The process is complete when you move the rsync switch (  ) to the  position to enable rsync.



## Restoring Backup Data

---

The procedure for restoring backup data varies depending on the backup mode. Refer to the following subsection corresponding to the backup mode you have used for backup. When restoring backup data, make sure you have enough available space on the TeraStation to accommodate the backup data, otherwise the restore process will fail.

### Full and Management Backups

Copy and paste the backed up files from the backup destination folder to a folder which you want to restore.

### Snapshot and Overwrite Backups (Incremental and Differential)

Files and folders, including snapshots, have already been stored on the desired destination. You can access them by switching the operation to the backup destination TeraStation. Alternatively, you can restore any files or folders by creating a backup job and configuring the backup destination as a backup source and selecting the same backup mode for the "Operation Mode" drop-down list. Do not use the same folder as the backup destination to restore backup data from multiple backup sources, as this may cause the restored data to get overwritten.

### iSCSI Backups

The backup data can easily be restored by creating a new backup job. Follow the procedure below.

Make sure that there is an iSCSI file I/O volume on the TeraStation which you want to use for restoring the backup data. If you do not have one already, refer to the ["Creating an iSCSI Volume"](#) section in chapter 4 to create one. Please be aware that the existing iSCSI file I/O volume will be overwritten by the restored backup data.

- 1 From Settings, click *Backup*.



- 2 Click the settings icon (  ) to the right of "Backup".



- 3** If you had configured a backup device access key for the backup source folder on another Buffalo NAS device or the backup destination folder, click *Set*. If you hadn't, skip to step 5.

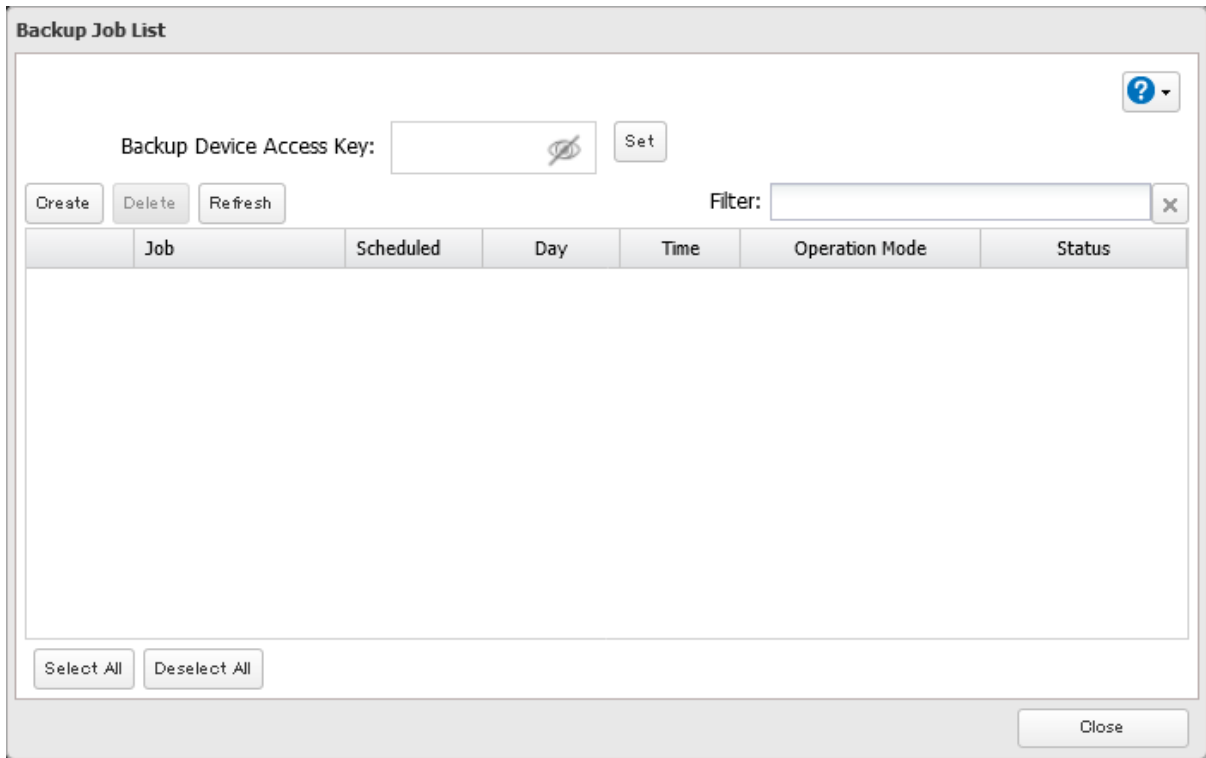

- 4** Enter the backup device access key and click *OK*.

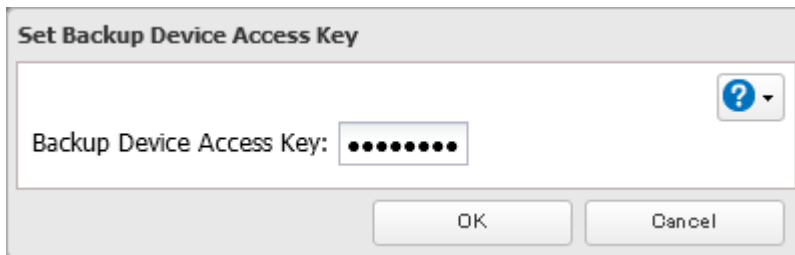

**5** Click *Create*.

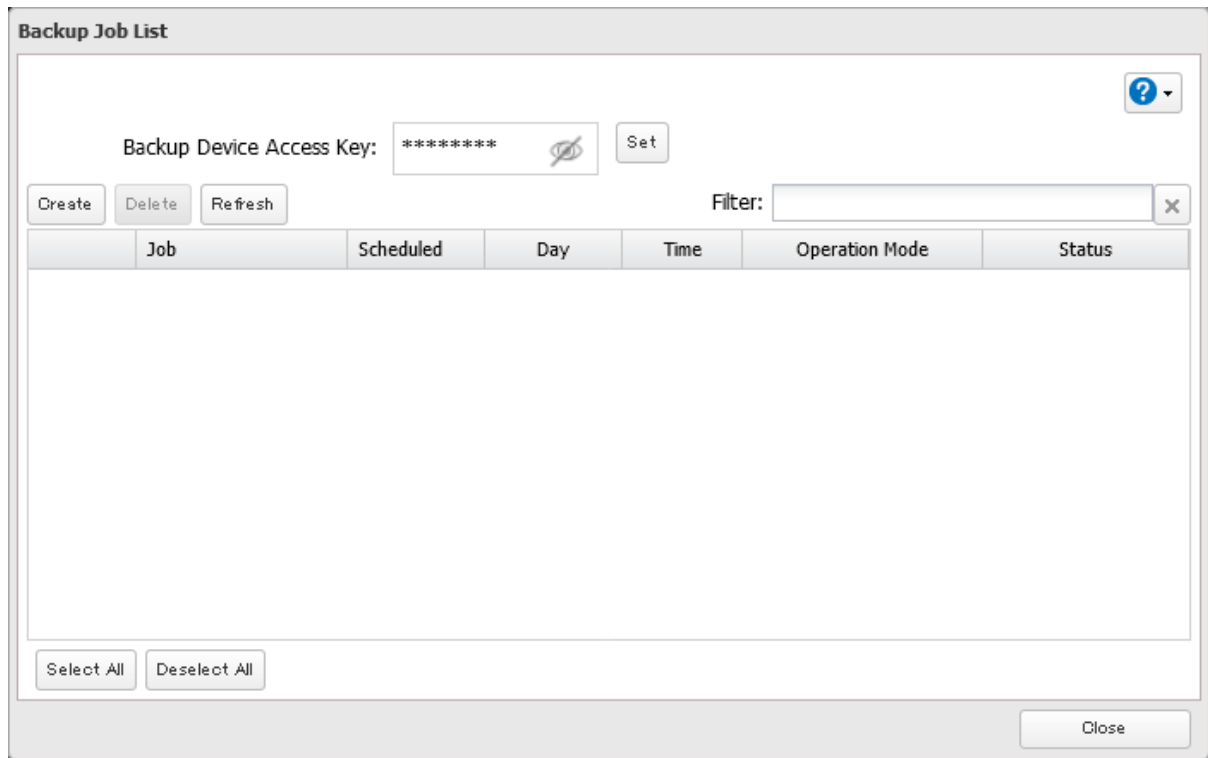

- 6** Select backup settings such as date and time to run, then select “iSCSI backup” for the “Operation Mode” drop-down list.

The screenshot shows the "Backup Job Settings" dialog box. At the top right, there is a red asterisk and the word "Required" next to a question mark icon. The "Job Name" field contains "job01". The "Schedule" is set to "Not scheduled", "Sunday", "00", and "00". The "Operation Mode" is set to "iSCSI backup". The "Versions" field is set to "10" with a checkmark for "Unlimited". Below these fields is an "Options" section with several checkboxes: "Create a subfolder for backup" (unchecked), "Create backup log file" (checked), "Save backup logs in the backup source folder" (radio button selected), "Select the folder to save backup logs" (radio button selected), "Target Folder:" (with a "Browse" button), "Encrypted data transfer" (unchecked), "Compress and transfer" (unchecked), "Ignore backup errors and continue backup job on schedule" (checked), "Do not back up recycle bin" (unchecked), "Overwrite unchanged files" (unchecked), and "Inherit subfolders' access restrictions" (checked). At the bottom of the dialog, there are "OK" and "Cancel" buttons. A note at the bottom of the options section reads: "If you change subfolders' access restriction settings after the backup job has run, it may not be carried over to the backup destination."

- 7** Read the message carefully and click *OK*.

- 8** Click *Add*.

- 9** Select the original backup destination as the backup source, then select an iSCSI file I/O volume as the backup destination.

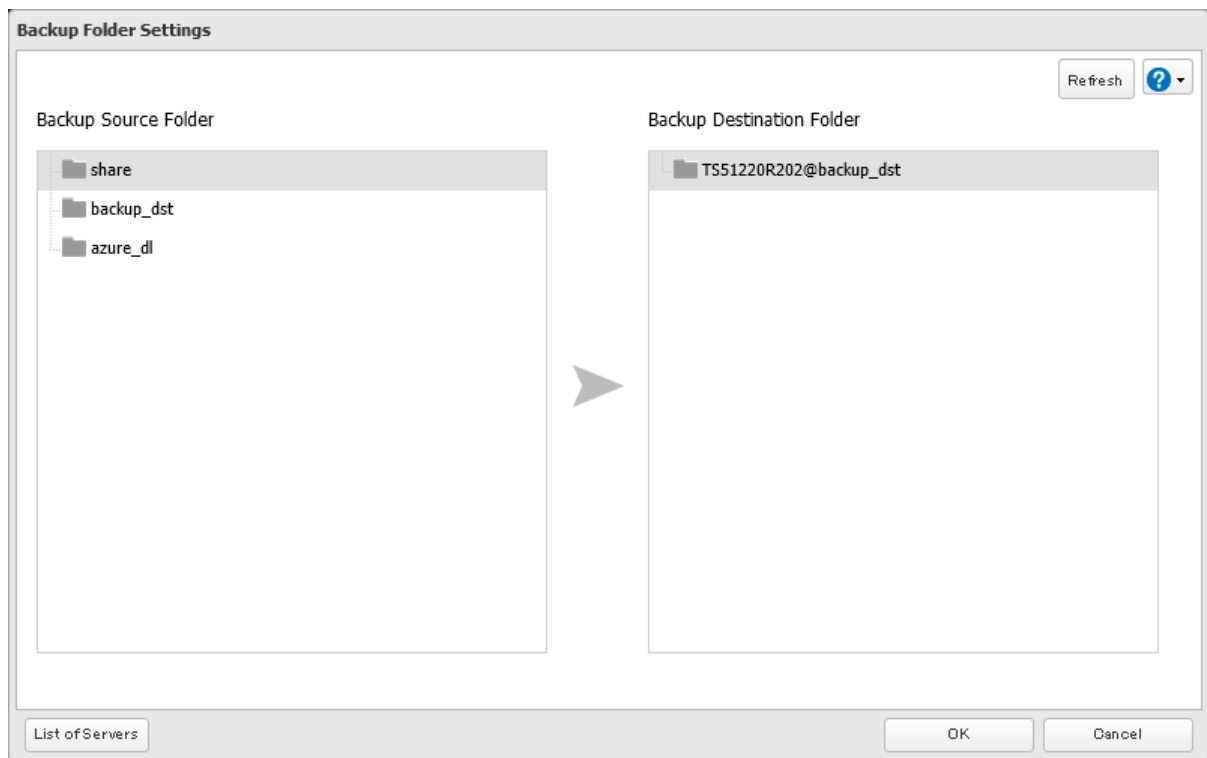

- 10** Click *OK*, then click *OK* again.

- 11** The process is complete once you close the confirmation window that appears. The backup job will be added to the backup jobs list.

The backup data will be restored on the backup destination after the backup job has run. If the backed up iSCSI volume is smaller than the backup source, and there is not enough space on the backup source to accommodate the backup data, the restore process will finish, but the backup source iSCSI volume will become corrupted.

## Backup Logs for If Backup Fails

If backup fails, the I54 message will appear as a notification and the following backup error codes may be displayed in the "Status" field. Read the description and try the respective corrective actions for each error to resolve it.

Code	Description	Corrective Action	Log Example
Code 3	The backup destination USB drive could not be found.	Check that the backup destination USB drive is connected to the TeraStation properly.	rsync error: errors selecting input/output files, dirs (code 3) at main.c(634) [Receiver=3.1.0]
			Can't write to backup destination(target disk is broken?).

Code	Description	Corrective Action	Log Example
Code 5	The backup destination shared folder could not be found.	Check that the Ethernet cable is securely connected and that the hub or other devices on the network are turned on.	rsync error: error starting client-server protocol (code 5) at main.c(1504)
	Authentication failed.	Try adding the rsync-compatible NAS device from the server list again.	@ERROR: auth failed on module
	A registered user does not have permission to run.	Check the settings of the rsync-compatible NAS device.	@ERROR: permission denied
Code 10	The Ethernet cable was disconnected from the backup source TeraStation when the backup job started.	Reconnect the Ethernet cable.	rsync error: error in socket IO (code 10) at clientserver.c(128) [sender=3.1.0pre1]
	A backup destination doesn't support the subfolders' access restrictions.	Select another backup destination or remove the subfolders' access restrictions.	
Code 11	The drive capacity of the backup destination TeraStation became full.	Delete unnecessary files and folders.	rsync error: error in file IO (code 11) at receiver.c(389) [receiver=3.1.0]
	Files larger than 4 GB were backed up to the FAT32-formatted USB drive.	Reduce the file size to 4 GB or less, or change the file system to one other than FAT32. Refer to the <a href="#">"Adding an External Drive"</a> section in chapter 4 for compatible file systems.	rsync: write failed on "filename": File too large (27)
Code 12	Could not communicate between backup source and destination TeraStations.	Check that the Ethernet cable is securely connected and that the hub or other devices on the network are turned on.	rsync error: error in rsync protocol data stream (code 12) at io.c(515)
	The settings of the TeraStation were changed while the backup job was running.	Do not change the settings while the backup job is running. If changed, the connection will temporarily terminate and the backup job will fail.	
Code 14	There was insufficient memory on the TeraStation so the backup job did not run.	Reduce the number of backup destination files or disable any other functions running at the same time.	ERROR: out of memory in flist_expand
Code 22			rsync error: error in IPC code (code 14) at main.c(655) [receiver=2.6.8]
			rsync: fork failed in do_recv: Cannot allocate memory (12)
Code 22			rsync error: error allocating core memory buffers (code 22) at util.c(120) [sender=2.6.8]
Code 20	The connection was disconnected while the backup job was running.	Do not change the settings while the backup job is running. If changed, the connection will temporarily terminate and the backup job will fail.	rsync error: received SIGINT, SIGTERM, or SIGHUP (code 20) at rsync.c(242)

Code	Description	Corrective Action	Log Example
Code 23	Invalid characters were used in the filename or folder name of the backup destinations.	Change the filename or folder name using compatible characters. Available characters are described in the <a href="#">“Adding a Shared Folder”</a> section in chapter 3.	rsync error: some files could not be transferred (code 23) at main.c(702)
	The backup destination files were updated while the backup job was running.	Do not overwrite the backup destination files while the backup job is running. If updated, the backup destination files will not be backed up and the backup job will fail.	
	The TeraStation backed up the data to the FAT32-formatted USB drive, then the capitalization of letters in the filenames or folder names on the backup source TeraStation was changed.	Do not change the capitalization of letters in the filenames and folder names on the backup source TeraStation if the backup destination USB drive is formatted to FAT32. Linux on the TeraStation is case-sensitive but FAT isn't, so files or folders with names that are identical save for the capitalization will not be identified and treated as the same file or folder. To back up properly, using Btrfs, XFS, or ext3 is recommended.	
	A file system on the backup destination may be corrupted.	Run a drive check on the backup destination by referring to the <a href="#">“Checking Drives”</a> section in chapter 4.	rsync recv_generator: failed to stat “filename”: Invalid argument (22)
Code 24	The backup destination files were updated while the backup job was running.	Do not overwrite the backup destination files while the backup job is running. If updated, the backup destination files will not be backed up and the backup job will fail.	rsync warning: some files vanished before they could be transferred (code 24) at main.c
Code 30	The Ethernet cable was disconnected from the backup source or destination TeraStations while the backup job was running.	Reconnect the Ethernet cable.	rsync error: timeout in data send/receive (code 30) at io.c(195) [sender=3.1.0]
B14	Insufficient TeraStation memory.	Restart the TeraStation and try again.	-
B101	The backup destination TeraStation does not exist.	Check that the backup destination TeraStation is turned on, the Ethernet cables are securely connected, and the hostname of the backup destination TeraStation has not been changed.	-
B102		Check that the backup destination folders on the backup destination TeraStation are on the shared folder list and the backup destination folders are configured for backup in Settings.	-

Code	Description	Corrective Action	Log Example
B103	The backup source folders on the backup source TeraStation do not exist.	Check that the backup source folders on the backup source TeraStation are on the shared folder list.	-
B104	The backup destination folders on the backup destination TeraStation do not exist.	Check that the backup destination folders on the backup destination TeraStation are on the shared folder list.	-
B105	The drives were not recognized.	Check that the drives are recognized properly in Settings. If you configure the "usbdisk" folders for the backup source or destinations, check whether these folders are on the shared folder list.	-
B106	The file systems of the USB drive are not supported.	Check that the USB drive is formatted to the compatible file systems. If you configure the management backup in the backup job, FAT format cannot be used for the backup destination.	-
B107	The device files such as "/dev/null" etc. do not exist.	Restart the TeraStation and try again.	-
B108	Credentials to access a shared folder on the rsync-compatible NAS device were not found.	Try adding the rsync-compatible NAS device from the server list again.	-

## Replication

Replication copies all data from one shared folder to another shared folder on a different TeraStation. This is an easy way to set up a reliable data protection system in the event your main TeraStation fails. To configure replication, connect an Ethernet cable to the LAN port of each TeraStation and follow the procedure below. For best results, use static IP addresses and a 10GbE port for connecting both replication TeraStations (source and destination).

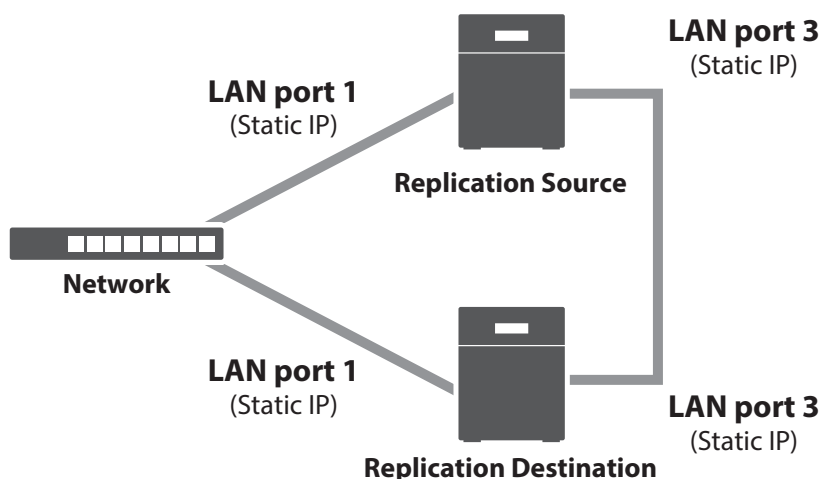

**Note:** Replication source data is copied to the replication destination folder with a differential overwrite. Any data not on the replication source will be overwritten.

The following describes what can be configured as replication sources and replication destinations.

## Folders Available as Replication Sources

- Shared folder on the replication source TeraStation

## Folders Available as Replication Destinations\*

- Shared folder on the replication source TeraStation
- Shared folder on another Buffalo NAS device\*\*

\*The folder should have the “Backup” checkbox selected under “LAN Protocol Support” on the shared folder settings.

\*\*If the “Inherit subfolders’ access restrictions” option is selected when creating a replication job, the device should be a Buffalo NAS device whose subfolders’ access restrictions is available.

## Preparing a Replication Destination

Configure a folder as a replication destination. Follow the procedure below to prepare a Buffalo NAS device as a replication destination.

**Note:** You cannot use the same replication destination folder for multiple replication source folders.

- 1 From Settings, click *File Sharing*.



- 2 Click the settings icon (  ) to the right of “Folder Setup”.



- 3 Choose the folder to be set as a replication destination.

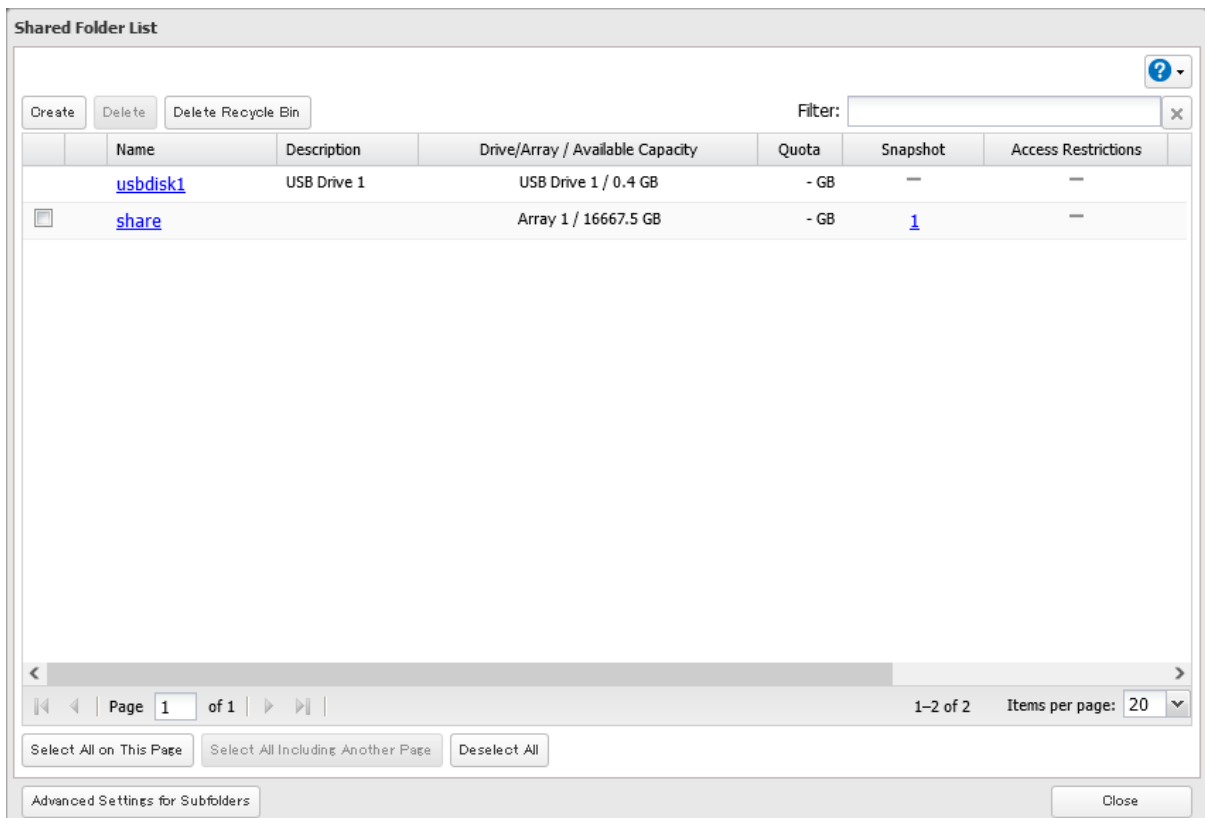

- 4** Under “LAN Protocol Support”, select the “Backup” checkbox on the *Basic* tab.

LAN Protocol Support:  SMB (Windows/Mac)  Backup  
 FTP  WebAccess  
 SFTP  
 NFS  
 — NFS Path \_\_\_\_\_

- 5** Click *OK* and proceed to the next step to create a backup device access key.

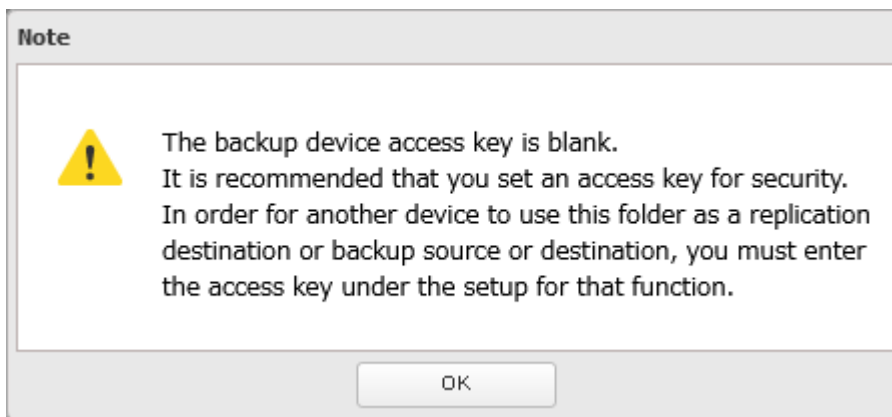

- 6** Enter the desired characters into the backup device access key field and click *OK*.

Backup Device Access Key:

**Note:** You may leave this field blank if you do not want a backup device access key, but for security reasons we highly recommend entering one for the shared folder. If a backup device access key is configured for the shared folder, that folder will not show up as the replication destination when configuring a replication job on another Buffalo NAS device unless it’s entered. You may create multiple folders using different backup device access keys for backup and replication, but only one access key can be used on the TeraStation. Folders that are configured with a different access key cannot be used.

- 7** The process is complete once you close the confirmation window that appears.



**Note:** If you want to replicate to a Buffalo NAS device on another network, follow the procedure below to add the Buffalo NAS device so it can be used as a replication destination.

- (1) Create a new replication job by referring to the [“Configuring a Replication Job”](#) section below.
- (2) On the screen that allows you to select a shared folder, click *List of Servers*.
- (3) Click *Add*; select the “Add Buffalo NAS device” option, enter the IP address or hostname of the destination Buffalo NAS device, then click *OK*.
- (4) Click *Close*.
- (5) Click *Refresh* and make sure the desired Buffalo NAS device has been added to the list.

## Configuring a Replication Job

- 1 From Settings on a replication source NAS device, click *Backup*.



- 2 Move the replication switch (  ) to the  position to enable replication.



- 3 Click the settings icon (  ) to the right of "Replication".



- 4 Click *Edit*.

- 5 If you had configured a backup device access key for the replication destination folder, click *Set*. If you hadn't, skip to step 7.

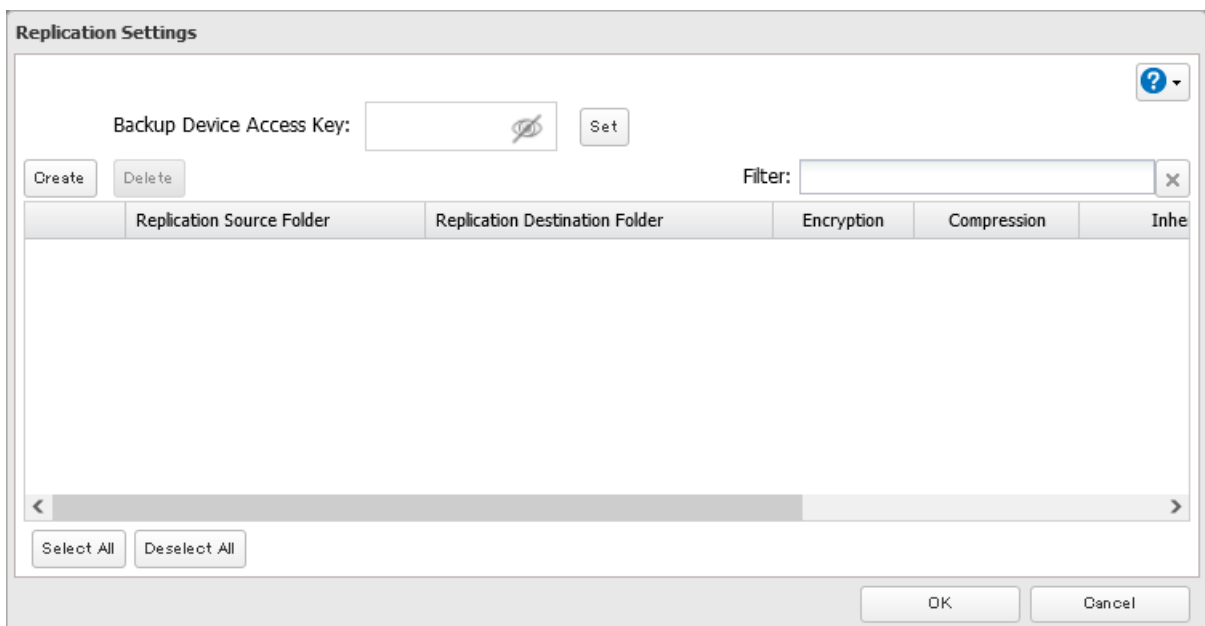

- 6 Enter the backup device access key and click *OK*.

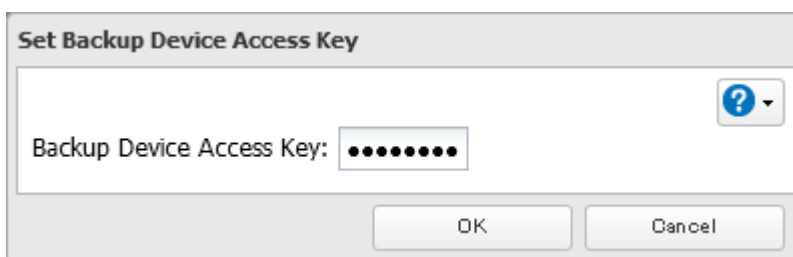

**7** Click *Create*.

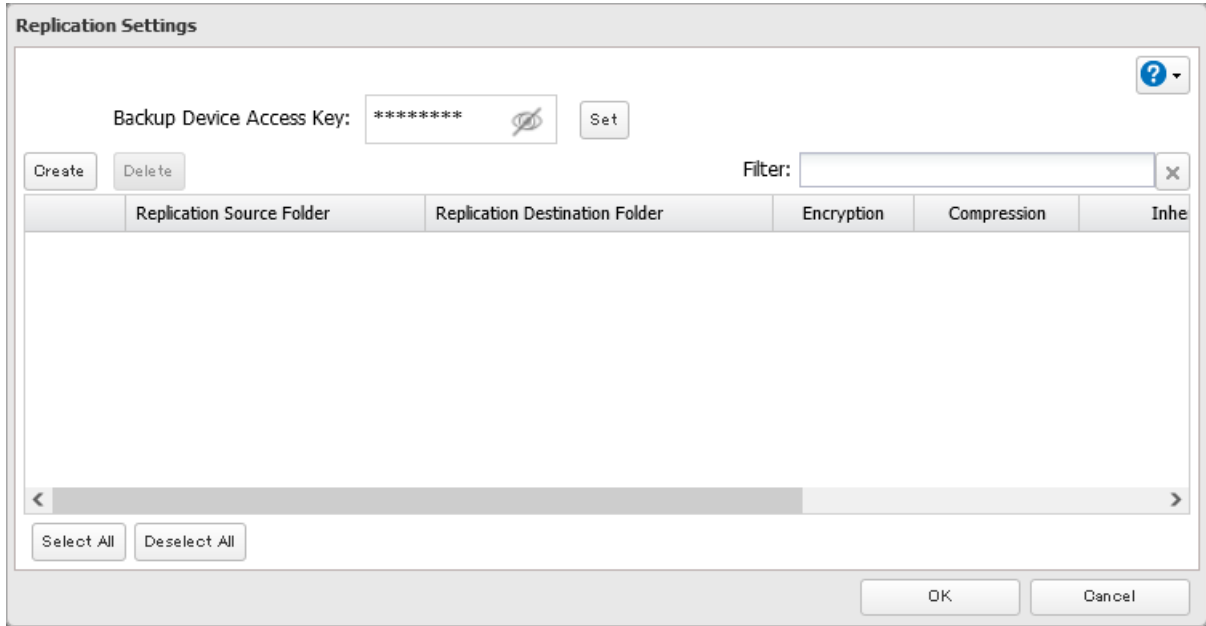

**8** Select the shared folders that will be the replication source and destination.

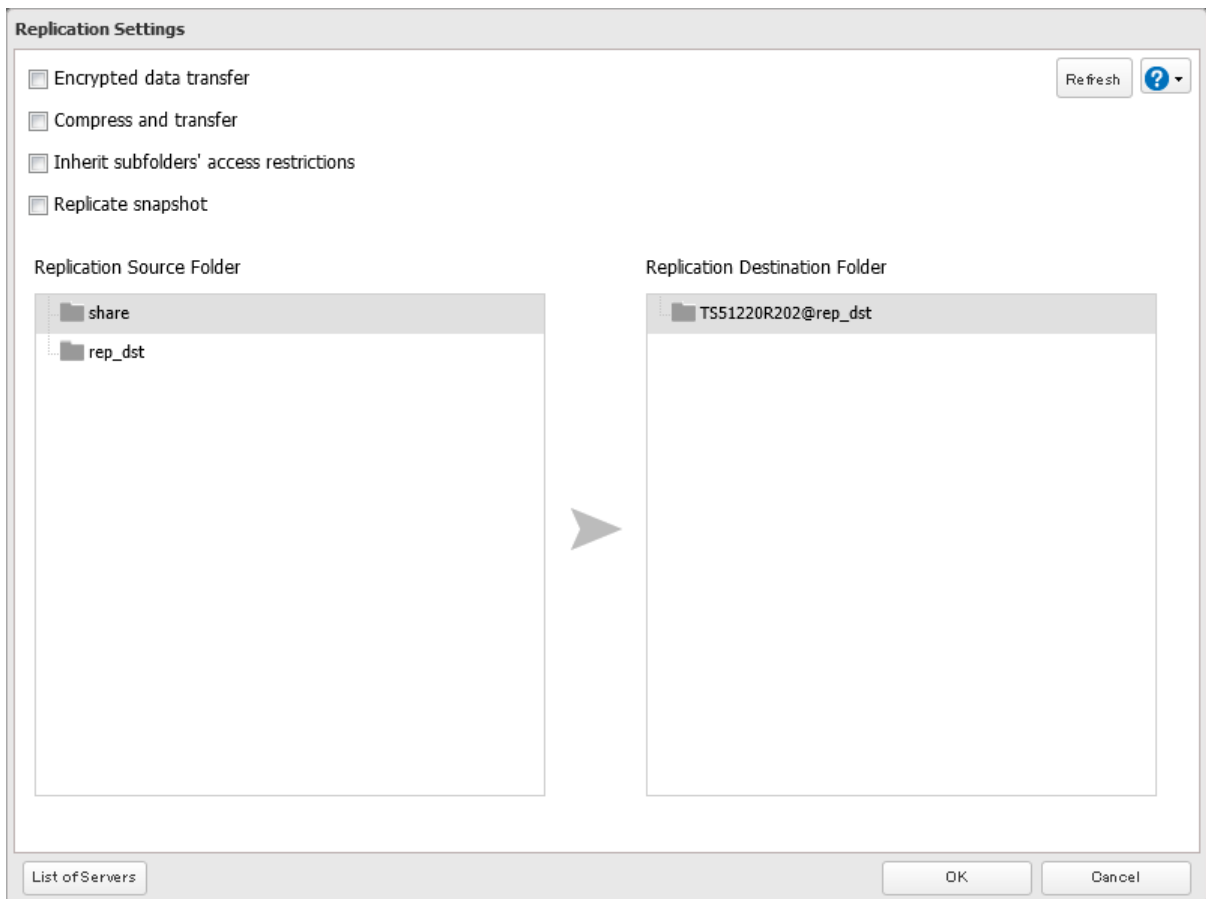

**9** Click *OK*, then *OK* again.

**10** Read the message carefully and click Yes.

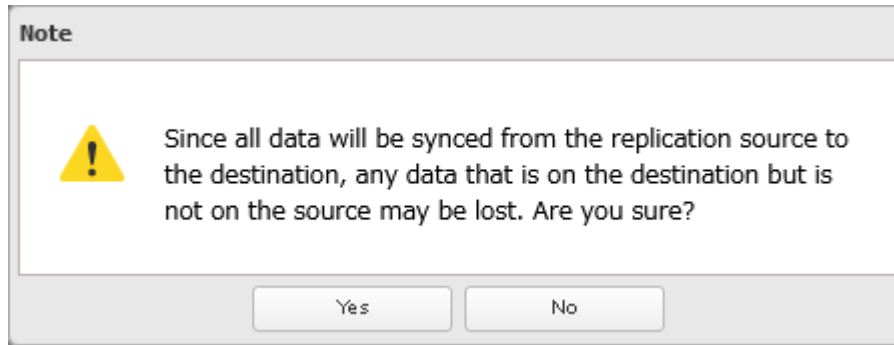

**11** The process is complete once you close the confirmation window that appears.

**Notes:**

- During setup, you may choose to encrypt and/or compress replication data. Encrypted data will be transferred securely on the network. Compressed data will ease network loading and is recommended for slow or heavily loaded network connections. Enabling either will increase the CPU load on the source TeraStation so that the transfer speed will become slower, and replication time will be slower than if they are disabled. Encrypted or compressed data will be decrypted or decompressed on the destination TeraStation.
- A maximum of 64 shared folders can be configured for replication.
- Don't use the same TeraStation for both failover and replication, or replication and Time Machine.
- Don't configure replication from one source folder to multiple destination folders.
- If a network problem causes a replication error, unsynced data may be shown as "0" even though replication is incomplete. Click *Resync* to recover from the replication error. All files from the source folder will be copied to the destination folder.
- You can specify the LAN port to use for replication such as "(LAN3)". However, if you connect two or more LAN ports to the same network, the faster LAN port will take priority even if you specify the LAN port used. For example, if both LAN port 1 and LAN port 3 are connected to the same network and LAN port 3 is faster, then that port will be used even if you had configured LAN port 1 to be the port used.  
To use a slower LAN port for replication in this environment, configure the LAN port settings to a different network segment.
- If you also want to replicate the subfolder's attributes (such as hidden files and read/write status) to the replication destination, select the "Inherit subfolders' access restrictions" option for replication options.

## Synchronizing Between Source and Destination TeraStations Periodically

To copy files that are saved via other file sharing protocols such as FTP to the replication destination regularly, configure "Periodic Sync" in Settings. Follow the procedure below.

**1** From Settings, click *Backup*.



**2** Click the settings icon (  ) to the right of "Replication".



### 3 Click *Periodic Sync*.

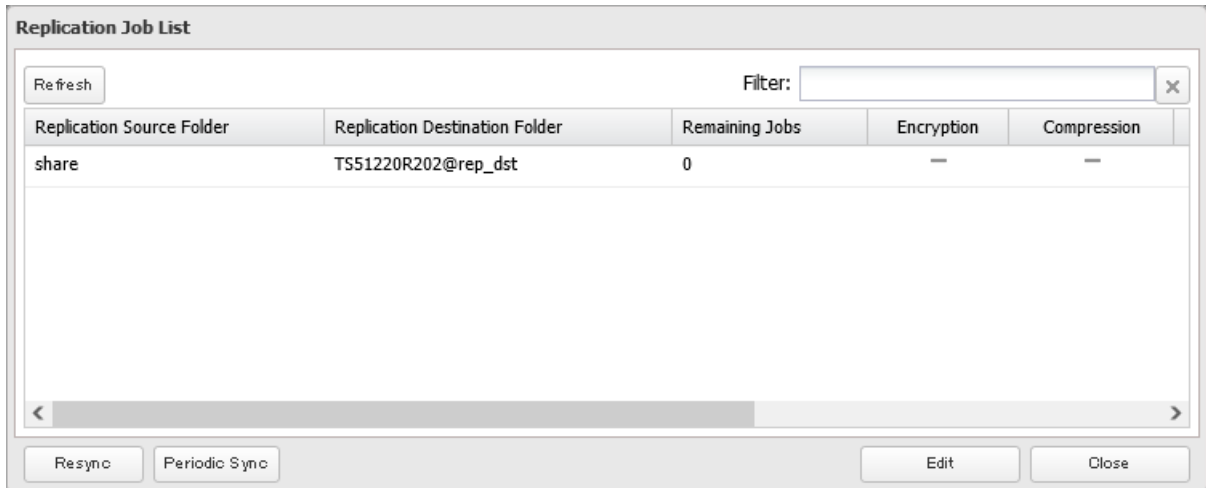

### 4 Select "Daily" or "Weekly" from the "Schedule" drop-down list. If "Daily" is selected, configure the sync period. If "Weekly" is selected, specify the weekdays and the sync period.

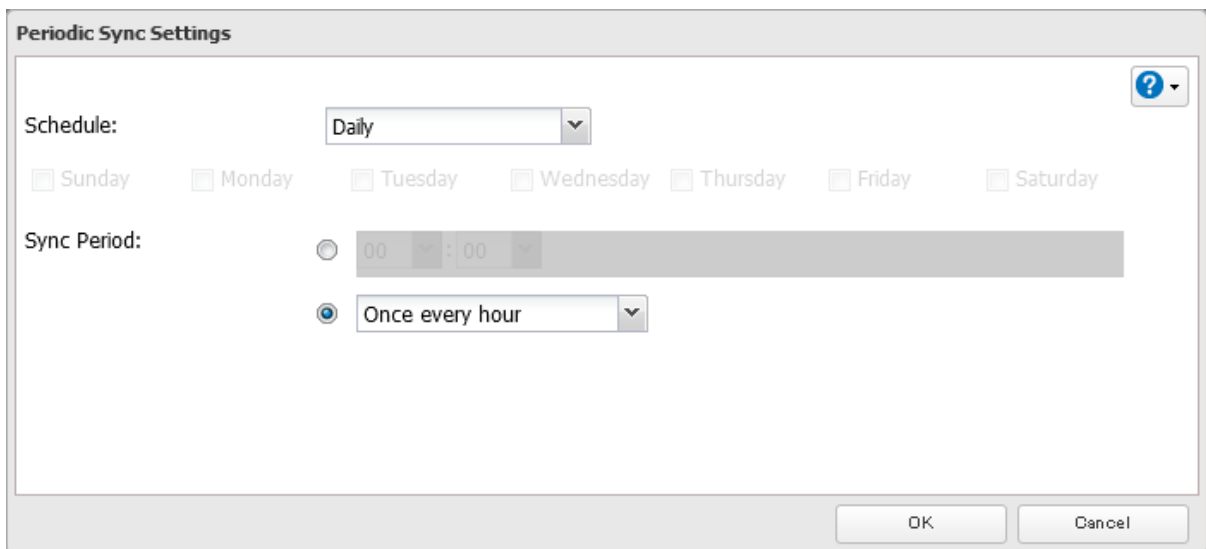

### 5 Click *OK*. The process is complete once you close the confirmation window that appears.

## Failover

With failover, two TeraStations are connected to the network for redundancy, with one being the main TeraStation and the other being the backup TeraStation. If an issue renders the main TeraStation inaccessible, operation automatically switches to the backup TeraStation.

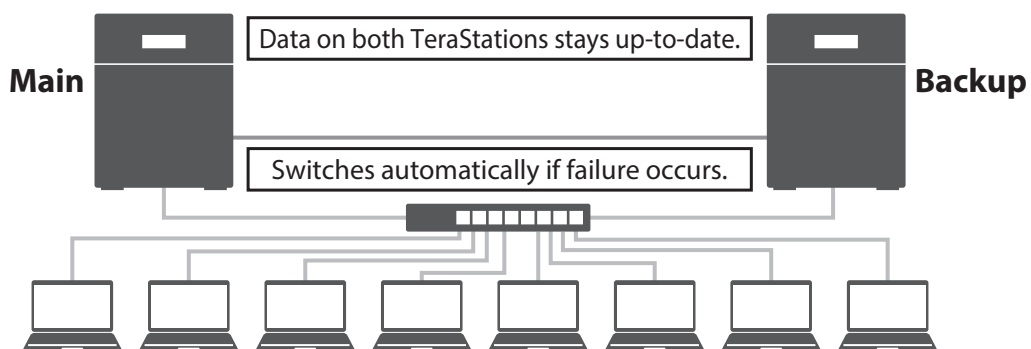

Failover will activate if any of the following occurs:

- **The backup TeraStation cannot detect the main TeraStation within a specified time**

If the backup TeraStation has not received a packet from the main TeraStation within a specified time, the backup TeraStation considers the main TeraStation to have failed. By default, it will try five times and wait 60 seconds. If this is triggered by accident, reconfigure failover from the main TeraStation.

- **Errors**

Failover will occur if any of the following errors occur:

E12 (cooling failure), E14 (cannot mount RAID array), E16\* (drive not found), E22\* (cannot mount drive), E30\* (drive failure)

\*This triggers when the drive is configured in JBOD.

## Before Configuring Failover

If you want to use both failover and Active Directory, configure Active Directory on the main TeraStation before configuring failover.

Also, use the same LAN ports for transferring data and configure both TeraStations with static IP addresses for the purposes of failover. It is recommended to use a 10GbE port for failover.

### Using the Same LAN Port for Both File Sharing and Failover

Using this setup, if the main TeraStation fails, the backup TeraStation will replace it completely. The backup TeraStation will be updated over normal network traffic.

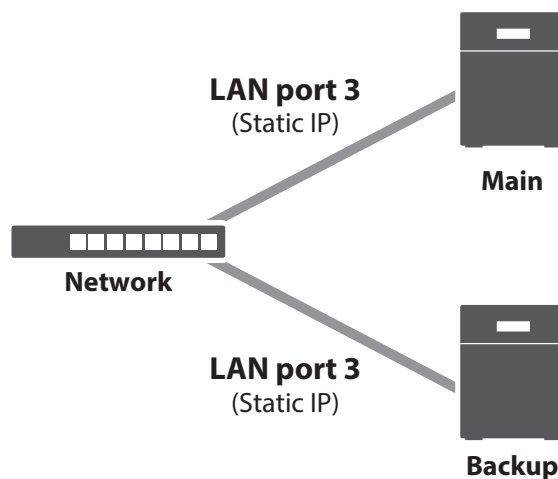

### Using Different LAN Ports Between File Sharing and Failover

With this setup, the backup TeraStation and main TeraStation are connected by a second Ethernet cable connecting their LAN port 3. Updating is done over this dedicated network path, so updates are quicker and don't interfere with normal network traffic.

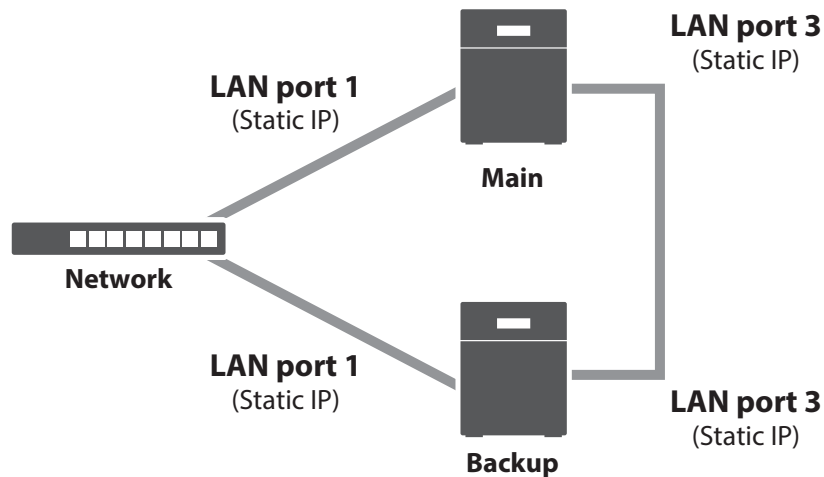

## Usage Restrictions

---

### Functional Restrictions

Failover is not available when any of the following functions are enabled:

Replication, sleep mode, LVM, iSCSI, port trunking, Amazon S3, Dropbox Sync, Microsoft Azure Storage Sync, Microsoft OneDrive Sync

Failover is not available when any of the following settings remain or have been configured:

Replication jobs, encrypted drive volume, Amazon S3 jobs, hot spare, access restrictions by Active Directory domain, multiple active LAN ports connecting to the same network

### Setting Restrictions

The following operations will not be available while failover is configured:

Initializing settings, changing the RAID settings, formatting drives, configuring iSCSI volume, changing the backup TeraStation's settings, turning the TeraStation on and off, updating the firmware

While failover is enabled, shutdown, power-on, and firmware update operations can be made available by temporarily putting the TeraStation into maintenance mode.

### Non-Transferable Settings

The settings below are not copied from the main TeraStation to the backup TeraStation. Make a note of the original settings so that they can be configured manually if a failover error occurs.

IP address, hostname\*, WebAccess, UPS sync, the backup job settings for either when shared folders not on the main TeraStation are specified or when a USB drive is set as the backup destination, USB drives' shared folder settings, low drive space alerts, and NFS rules

\*Since the hostname will not be transferred, use the virtual IP address configured for failover to access the shared folder after failover setup.

### Using with UPS

Once failover is configured, you cannot set up a UPS for the backup TeraStation. Configure your UPS before configuring failover. UPS recovery can be configured for both the main and backup TeraStations.

## Configuring Failover

**1** From Settings for the main TeraStation, click *Backup*.



**2** Click the settings icon (  ) to the right of "Failover".



**3** Click *Configure Failover*.

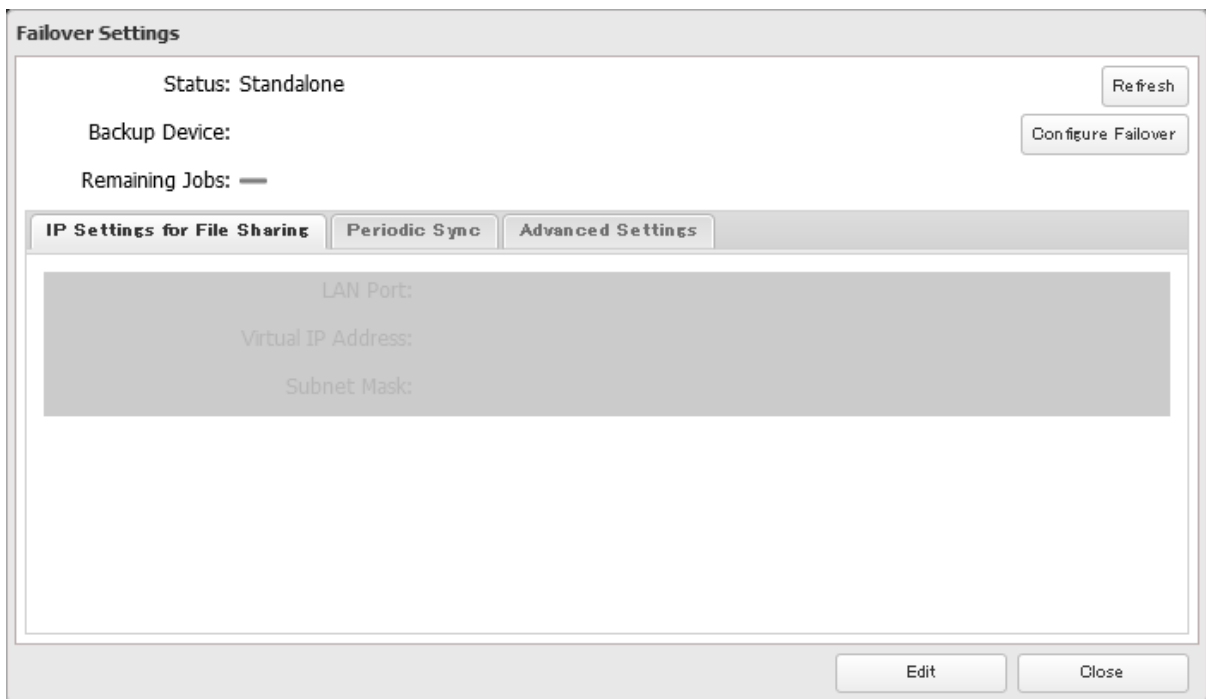

- 4** Select a TeraStation to be the failover backup device and enter its administrator username and password (by default, the username is “admin” and the password is “password”).

- 5** Select the LAN port to be used for sharing files and enter a virtual IP address. The LAN port you have selected here will also be used for pinging. If you select the same LAN port as the backup LAN port, the backup TeraStation will replace the main TeraStation even if just a network error occurs.

**About virtual IP addresses:** A virtual IP address is an IP address that will be used for file sharing while failover is configured. By assigning a different IP address from the one to be assigned to the LAN port, you can access the TeraStation for sharing files, as well as open Settings using the virtual IP address. This IP address will be inherited to the backup TeraStation when failover occurs, so you can access the backup TeraStation even if you don’t know the backup TeraStation’s static IP address.

Configure an unused IP address for the virtual IP; make sure it uses the same segment as the main and backup TeraStations.

- 6** Select the LAN port to be used for transferring data via failover.
- 7** Configure whether or not to inherit the settings of subfolders’ access restrictions to the backup TeraStation, then click *Continue*.

If you also want to copy the subfolder’s attributes (such as hidden files and read/write status) to the backup TeraStation, select “Inherit”.

- 8** If the admin username and password is correct, the **I51** message will appear as a notification for both main and backup TeraStations, and the backup TeraStation will beep. Press and hold down the function button on the backup TeraStation to accept the settings from the main TeraStation. When you press the function button, the backup TeraStation will stop beeping.

- 9 Press the function button. When you press the function button, the TeraStation will beep once. Press and hold down the button until the backup TeraStation beeps again.
- 10 Initialization on the main and backup TeraStations will begin. Wait until the I51 message disappears.
- 11 Reload the page to refresh the displayed items.
- 12 From Settings, click *Backup*.



- 13 The process is complete when "Normal (main device)" is displayed for "Failover". If it shows "Standalone" still, try reconfiguring failover from the first step.



#### Notes:

- Only use identical model and capacity TeraStations for failover. If the capacity of the main TeraStation is larger than that of the backup TeraStation, an I33 replication error will occur.
- All drive bays of a TeraStation should be occupied if it will be used for failover. Failover will not work if a drive is missing from any bay.
- If replication is configured for more than one folder, initialize the TeraStation before configuring failover.
- The main TeraStation cannot be used as the backup location for Time Machine.
- Do not use the same TeraStation for both failover and replication, or failover and Time Machine.
- If email notification is enabled and failover occurs, navigate to *Management > Email Notification > Edit* in the main TeraStation's Settings and click *OK*.
- MTU size settings for main and backup TeraStations should be 1,500 bytes. To change the MTU size, refer to the "[Jumbo Frames](#)" section in chapter 9.
- Files whose filenames contain more than 80 alphanumeric characters will not be backed up.
- If the I33 message appears as a notification, navigate to *Backup > Failover > Configure Failover* and click *Resync*.
- The RAID array on the backup TeraStation may be reconfigured and resynchronized as part of the failover configuration process. This is expected behavior and not an error.
- Failover cannot be configured while the TeraStation cannot communicate with the proxy server. If the TeraStation is located on a network that cannot communicate with the proxy server, disable the proxy server settings before configuring failover. After configuration finishes, enable the proxy server settings again.

## Changing Settings While Failover Is Configured

Before changing any TeraStation settings while failover is configured, make sure the TeraStation has entered into maintenance mode. If you change any settings without entering into maintenance mode, the I49 message may appear.

For the procedure to enter maintenance mode, refer to the "[Maintenance Mode](#)" section below.

## Maintenance Mode

The TeraStation has certain settings that cannot be configured or modified while other existing settings are in effect, such as failover. In such a case, putting the TeraStation into maintenance mode allows you to change certain TeraStation settings without affecting existing settings.

Follow the procedure below to make the TeraStation enter into maintenance mode.

**1** From Settings for the main TeraStation, click *Backup*.



**2** Click the settings icon (  ) to the right of "Failover".

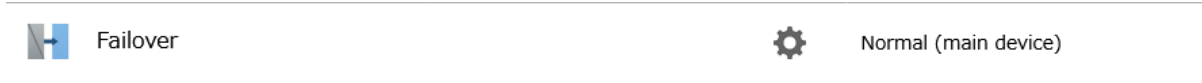

**3** Click *Configure Failover*.

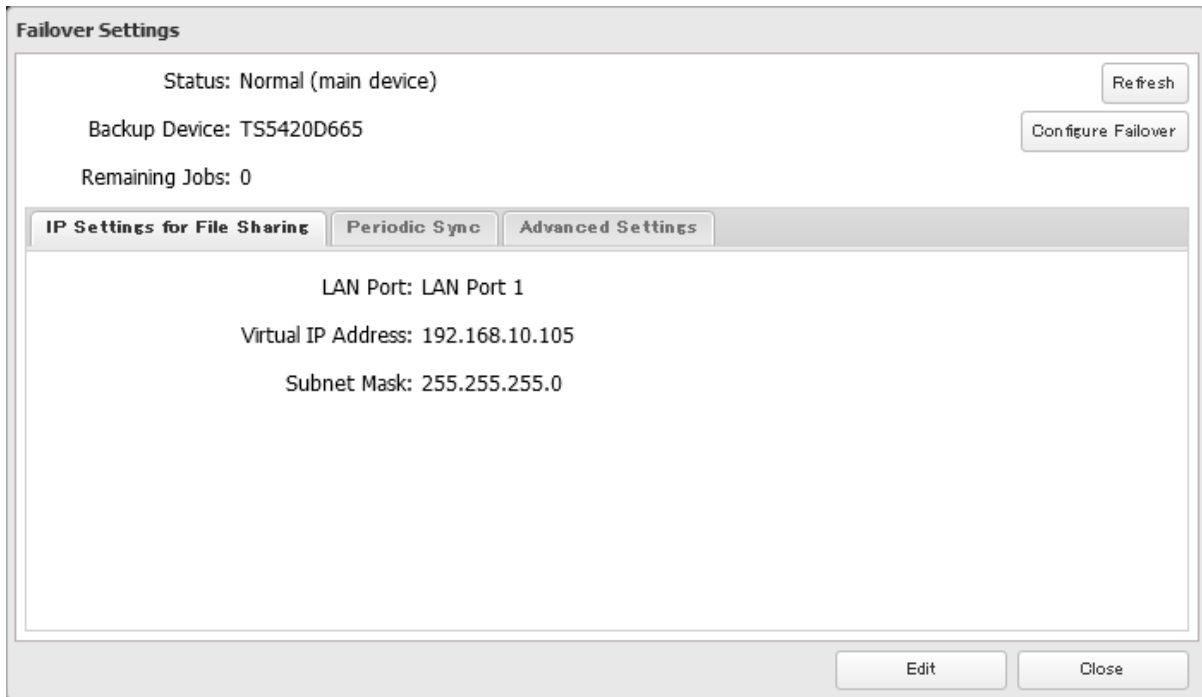

#### 4 Click *Maintenance Mode*.

**Failover Settings** \*Required 

Backup Device:	TS5420D665
Administrator Password:	*****
Snapshot:	Copy
Access Restrictions for Subfolders:	Inherit

Use TeraStations of the same model and storage capacity for the main and backup units. Set the MTU size to 1,500 bytes for both units.

Maintenance Mode
Resync
Force Failover to Stop
Stop Failover
Close

#### 5 Read the message carefully and click *Yes*.

**Note**



The maintenance mode is for temporary use, such as change location or update firmware. When you're finished with maintenance, click 'Cancel maintenance mode' to go back to normal mode.

Yes
No

#### 6 The process is complete once the TeraStation enters maintenance mode.

Once you are finished with changing settings in maintenance mode, make sure the TeraStation leaves maintenance mode. You can make the TeraStation leave maintenance mode by either pressing and holding the function button, or follow the procedure below to exit maintenance mode from the main TeraStation's Settings. Follow the procedure below to exit maintenance mode from the main TeraStation's Settings.

- 1 From Settings for the main TeraStation, click *Backup*.



- 2 Click the settings icon (  ) to the right of "Failover".



- 3 Click *Configure Failover*.

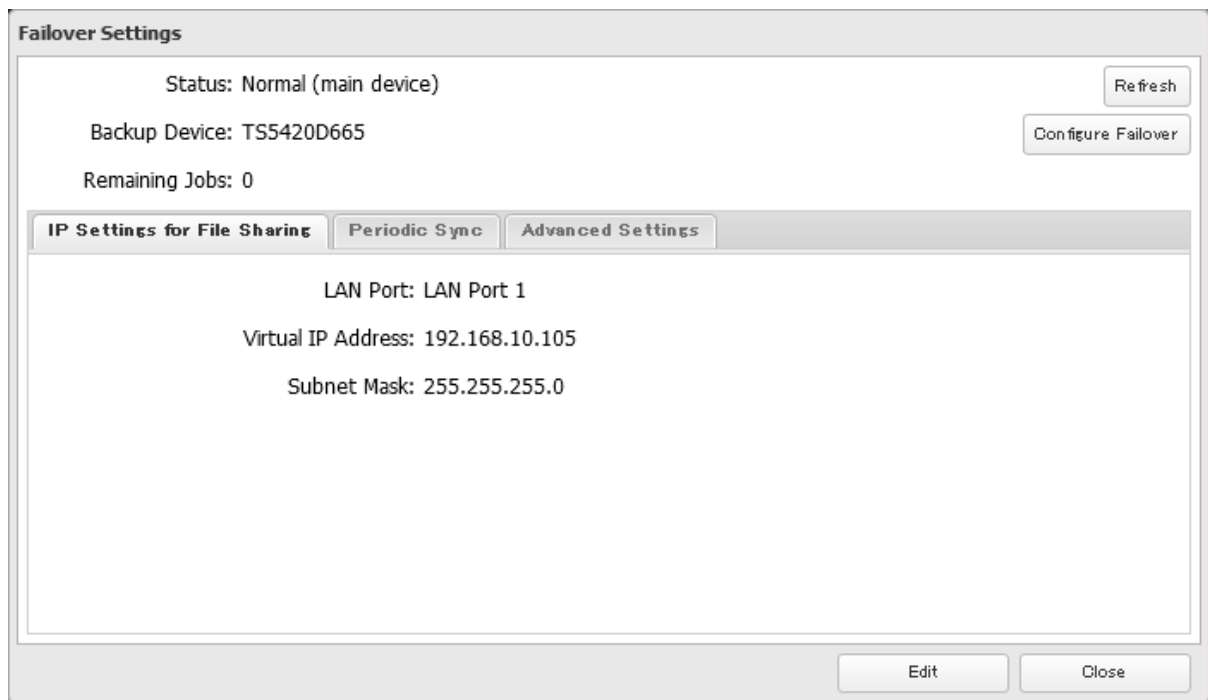

- 4 Click *Cancel maintenance mode*.

- 5 The process is complete once you close the confirmation window that appears.

**Note:** To update the firmware while in maintenance mode, the main TeraStation can be updated from Settings, but the backup TeraStation cannot. Download the firmware updater from the [Buffalo website](#) for the backup TeraStation and try updating the firmware on it.

## **Synchronizing Between Main and Backup TeraStations Periodically**

To copy files that are saved via other file sharing protocols such as FTP to the backup TeraStation regularly, configure "Periodic Sync" in Settings. Follow the procedure below.

- 1 From Settings for the main TeraStation, click *Backup*.



- 2 Click the settings icon (  ) to the right of “Failover”.



- 3 Click the *Periodic Sync* tab.

**Failover Settings**

Status: Standalone Refresh

Backup Device: Configure Failover

Remaining Jobs: —

**IP Settings for File Sharing**   **Periodic Sync**   **Advanced Settings**

LAN Port:

Virtual IP Address:

Subnet Mask:

Edit   Close

- 4 Click *Edit*.

- 5 Select “Daily” or “Weekly” from the “Schedule” drop-down list and click *OK*. If “Daily” is selected, configure the sync period. If “Weekly” is selected, specify the weekdays and the sync period.

**Failover Settings**

Status: Standalone \*Required 

Backup Device: Configure Failover

**IP Settings for File Sharing**   **Periodic Sync**   **Advanced Settings**

Schedule: Daily

Sunday    Monday    Tuesday    Wednesday    Thursday    Friday    Saturday

Sync Period:

00 : 00

Once every hour

OK   Cancel

**6** The process is complete once you close the confirmation window that appears.

## Switching to the Backup TeraStation Manually

If “Switch to backup unit manually” is selected on the *Advanced Settings* tab in the main TeraStation’s Settings, the backup TeraStation will not replace the main TeraStation if the main TeraStation fails. To manually replace the main TeraStation with the backup TeraStation, you can either:

- Log in to Settings for the backup TeraStation and click *Set as Main Unit*.
- Press the function button on the backup TeraStation. The TeraStation will beep once. Press and hold down the function button until the backup TeraStation beeps again.

**Note:** If the main TeraStation fails but all LAN port connections on the backup TeraStation remain active, you cannot replace the main TeraStation with the backup TeraStation from Settings. In such a case, use the function button instead.

## Reconfiguring After Failover Occurs

When the backup TeraStation replaces the main TeraStation, the **I49** message may appear as a notification on the backup TeraStation. To configure failover again, follow the procedure below using a new TeraStation unit. The following procedure is an example using the replaced backup TeraStation (“main TeraStation”) and the new TeraStation (“backup TeraStation”).

If you don’t want to configure failover with the new TeraStation, cancel the failover settings by following steps 1–5 below and restart both TeraStations. The **I49** message will disappear.

**Note:** The following procedure will also work if failover occurs unexpectedly.

**1** After failover occurs, log in to Settings for the new main TeraStation.

If you have configured to synchronize with the UPS device connected to the failed TeraStation, the **E10** error will appear as a notification on the main TeraStation. In such a case, follow the procedure below to change the UPS settings on the new main TeraStation. If you hadn’t, skip to the next step.

- Disconnect the UPS cable from the failed TeraStation and connect it to the main TeraStation.
- Click *Management*.
- Click the settings icon (  ) to the right of “Power Management”.
- Click *Edit*.
- Select “Sync with UPS connected to this TeraStation” and reconfigure the desired UPS settings.
- Click *OK*.

**2** Click *Backup*.



**3** Click the settings icon (  ) to the right of “Failover”.



**4** Click *Configure Failover*.

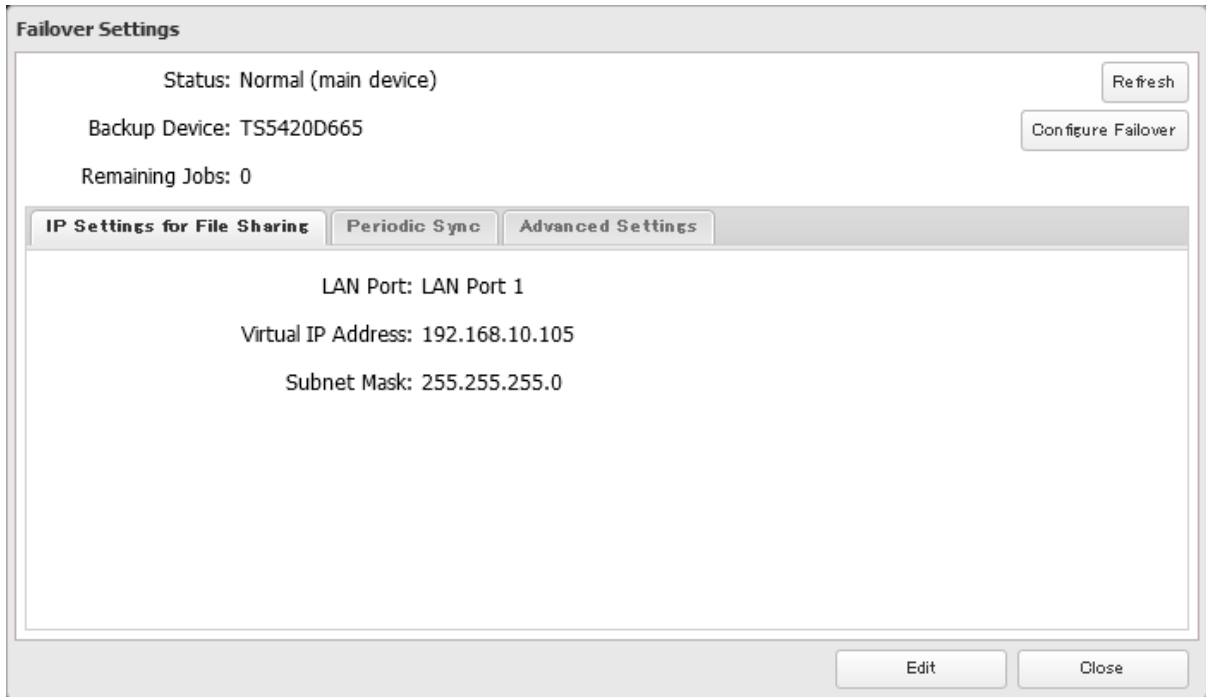

**5** Click *Force Failover to Stop* to cancel the failover settings.

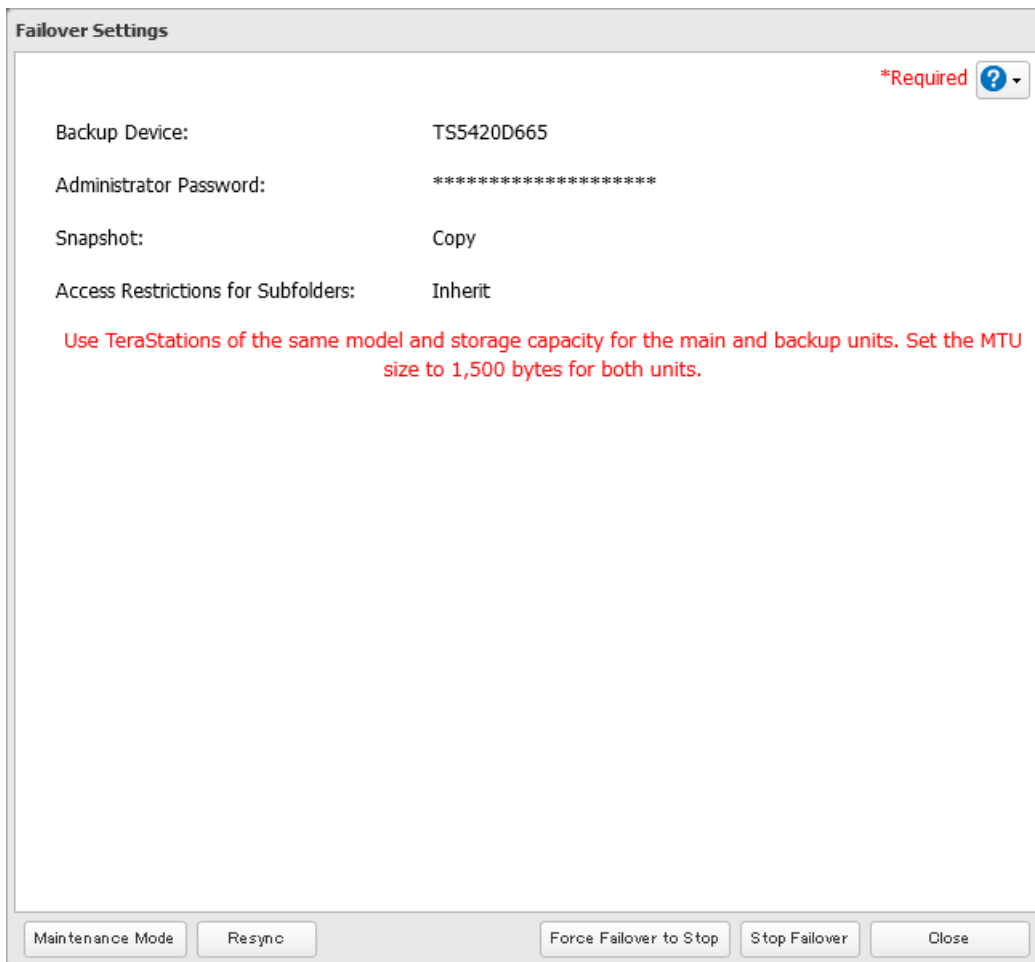

**6** Shut down this main TeraStation.

**7** Turn the backup TeraStation on.

**8** Log in to Settings for the backup TeraStation, then rename the TeraStation's hostname and configure the IP address so that it has a new static IP address.

**9** Power on the main TeraStation. To configure the UPS sync on the backup TeraStation, configure the settings here. Otherwise, skip to the next step.

To synchronize with the UPS device connected to the main TeraStation, follow the procedure below on the backup TeraStation.

a. Click *Management*.

b. Click the settings icon (  ) to the right of "Power Management".

c. Click *Edit*.

d. Select "Sync with UPS connected to another Buffalo NAS device on the same network" and configure the main TeraStation as a sync source.

e. Click *OK*.

**10** The process is complete once you reconfigure failover by referring to the "[Configuring Failover](#)" section above.

## Stopping Failover

---

If you want to stop failover while both the main and backup TeraStations are working properly, follow the procedure below.

### Stopping from the Main TeraStation

**1** From Settings for the main TeraStation, click *Backup*.



**2** Click the settings icon (  ) to the right of "Failover".



**3** Click *Configure Failover*.

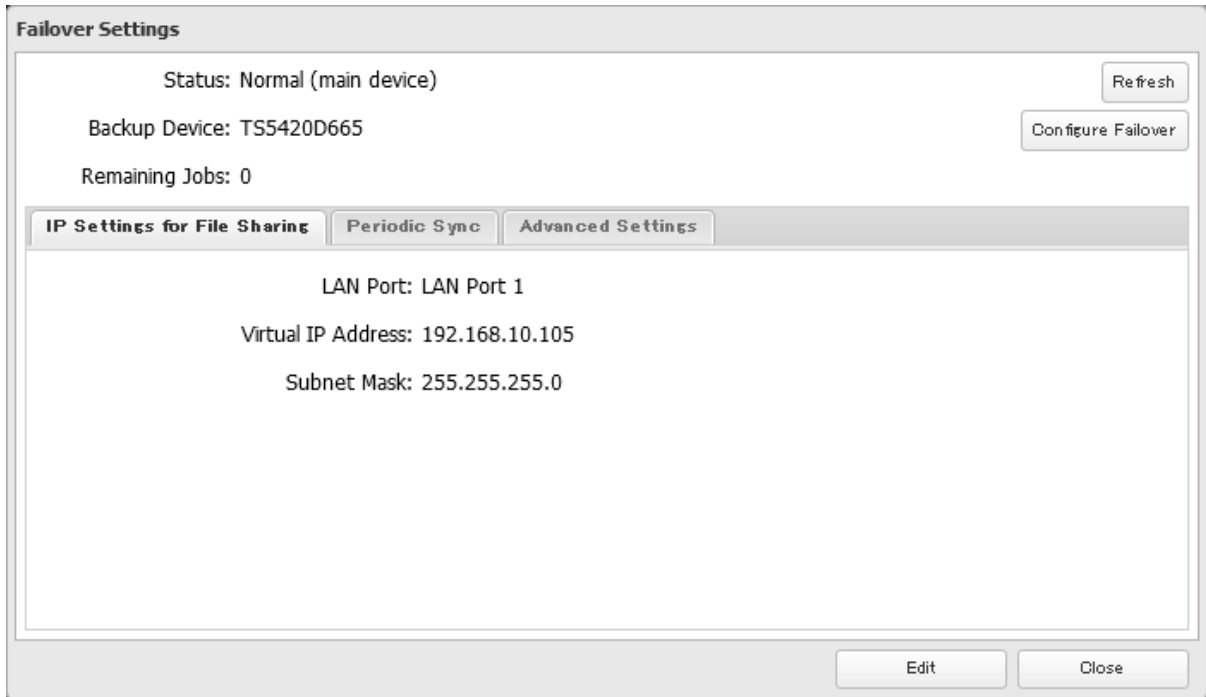

**4** Click *Stop Failover*.

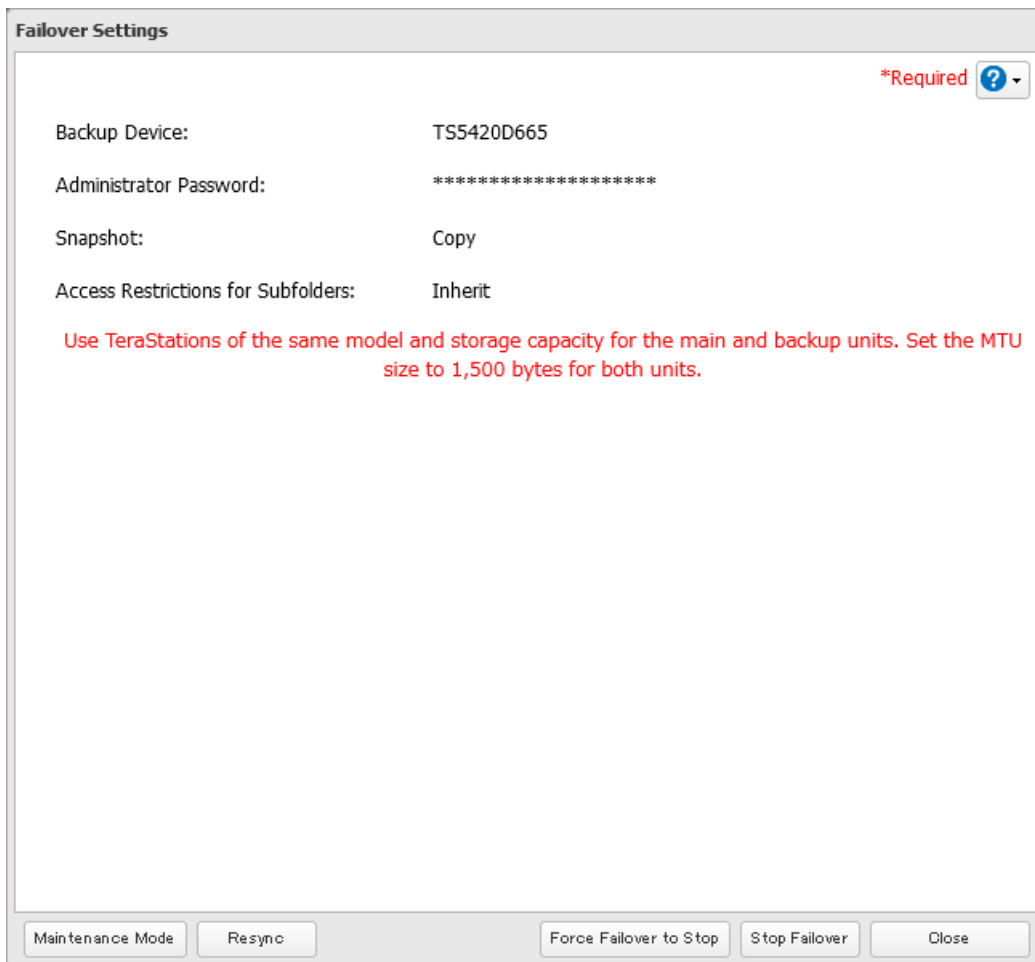

**5** The process is complete once you close the confirmation window that appears.

## Stopping from the Backup TeraStation

Log in to Settings for the backup TeraStation and click *Force Failover to Stop*.

## Stopping Failover Forcibly

If failover hasn't been stopped by taking actions from both the main and backup TeraStations, navigate to *Backup > Failover > Configure Failover* in Settings for the main TeraStation and click *Force Failover to Stop* to restart both TeraStations. After the TeraStations are restarted, make sure that all settings such as IP address and files in the shared folders are unchanged.

When you forcibly stop failover, attributes of the shared folders on the backup TeraStation will become read-only. Change the attribute settings to the desired options if necessary.

# Backing Up Your Mac with Time Machine

Time Machine is a backup program included with macOS. Configure your TeraStation as shown below to use Time Machine.

## 1. Configuring a Shared Folder as a Backup Destination

- 1 From Settings, click *Backup*.



- 2 Click the settings icon (⚙️) to the right of "Time Machine".

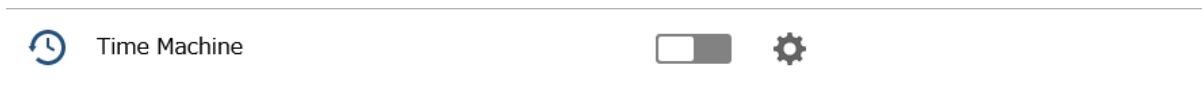

- 3 Click *Edit*.

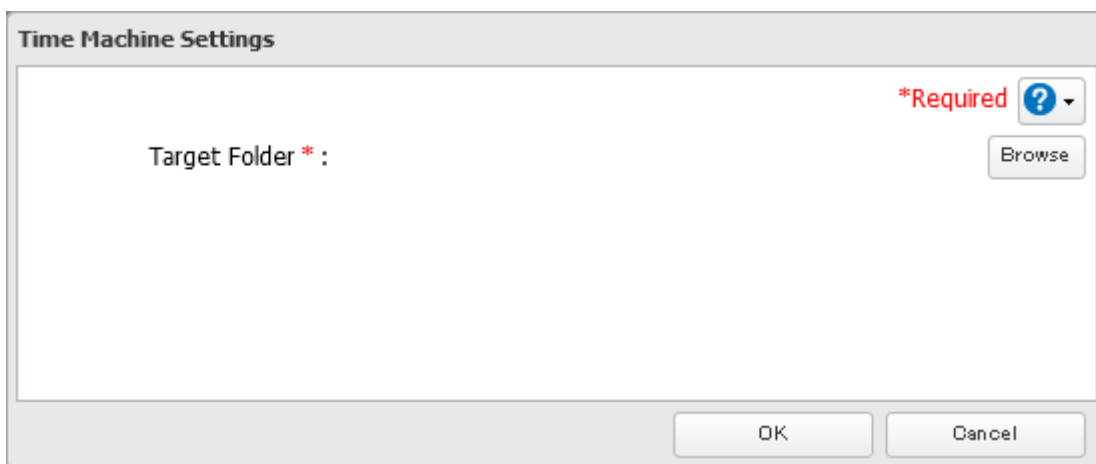

- 4 Click *Browse*.

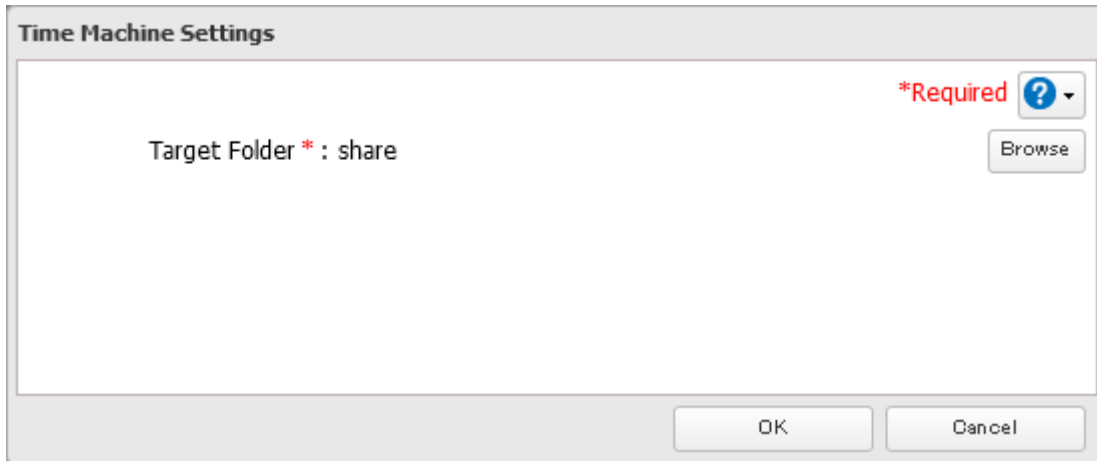

**5** Select the shared folder and click *OK*.



**6** Click *OK*, then click *OK* again.

**7** The process is complete when you move the Time Machine switch (  ) to the  position to enable Time Machine.



**Note:** We recommend adding a quota to limit the backup shared folder space that can be used for Time Machine. If you don't add a quota, Time Machine will continue to use all available space. To configure quotas, refer to the ["Quotas"](#) section in chapter 4.

## 2. Configuring Time Machine on macOS

**1** From the Apple menu, open *System Preferences*.

**2** Click *Time Machine*.

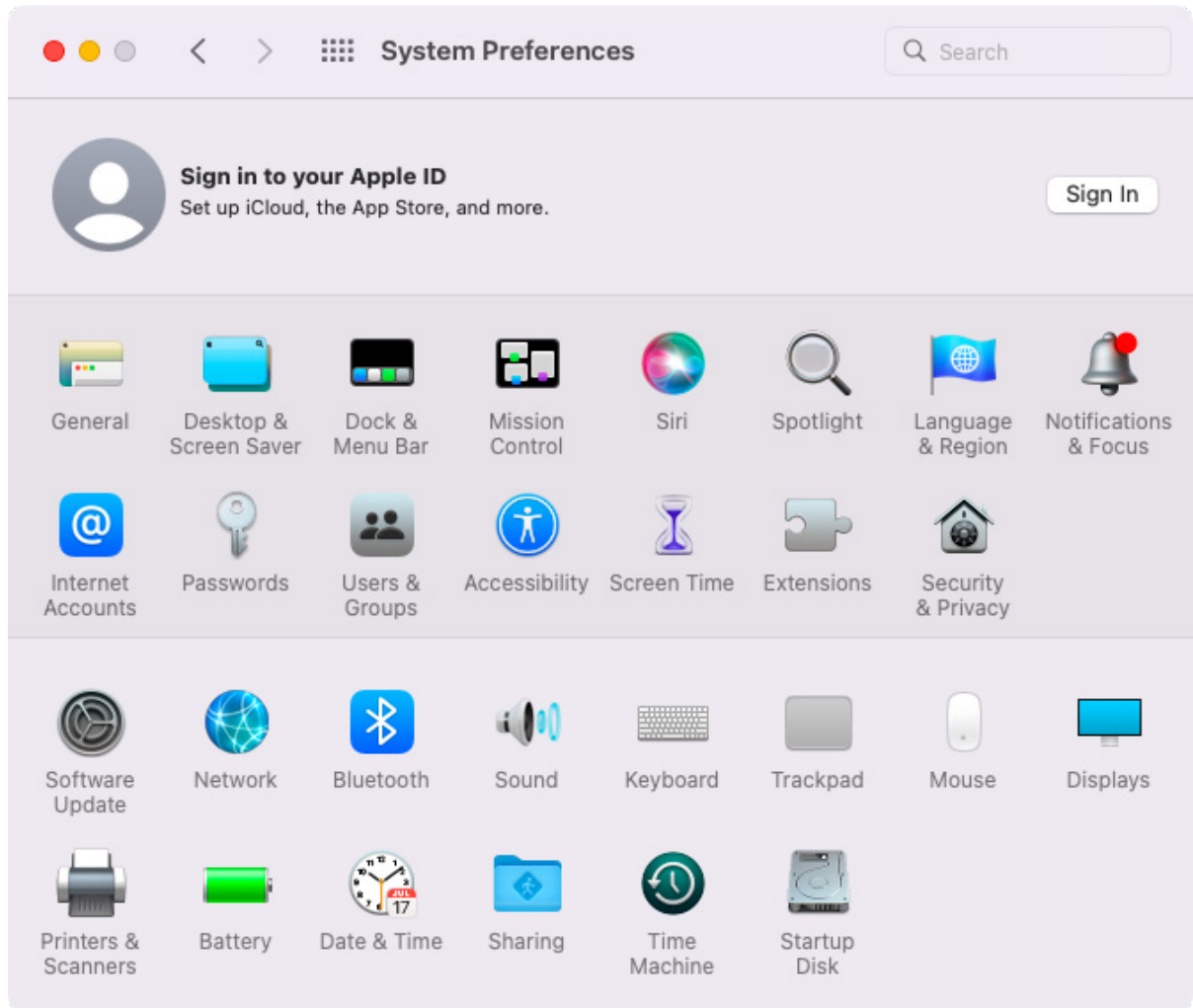

**3** Click *Select Backup Disk*.

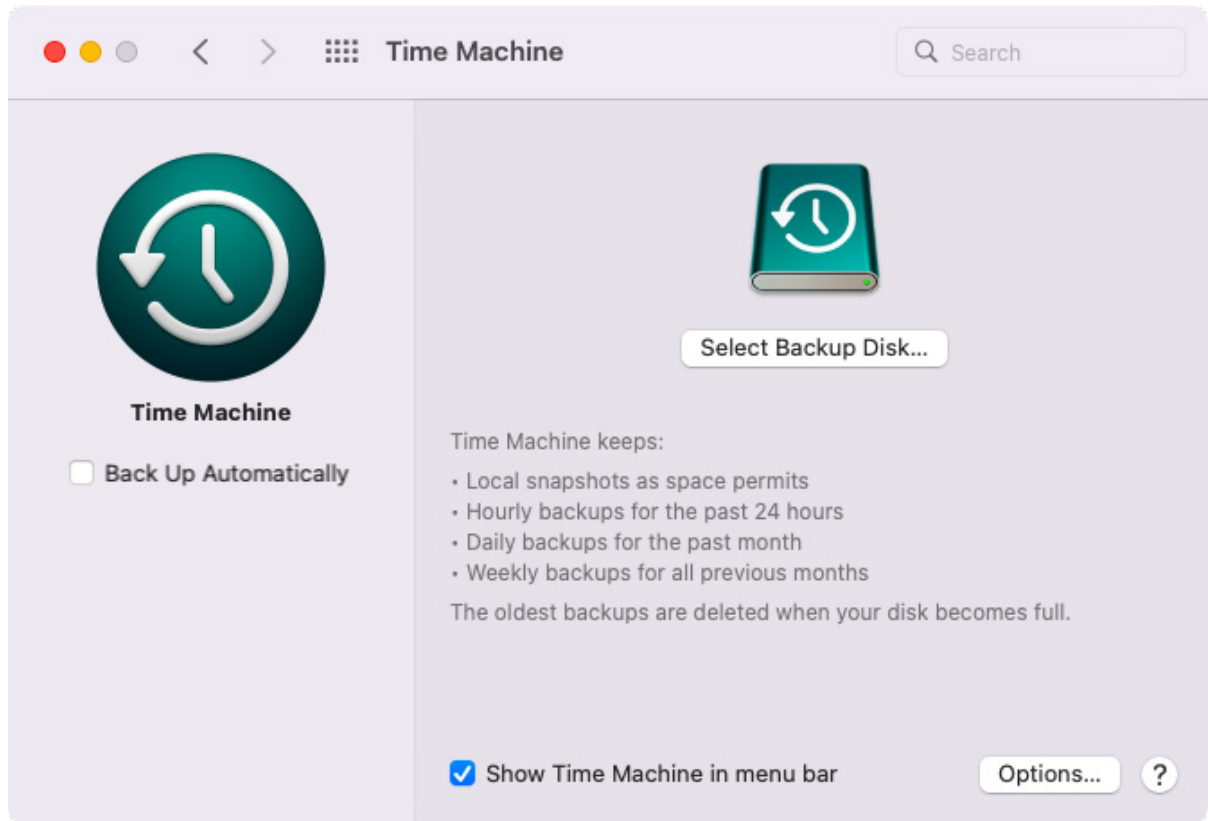

**4** Select the shared folder, then click *Use Disk*.

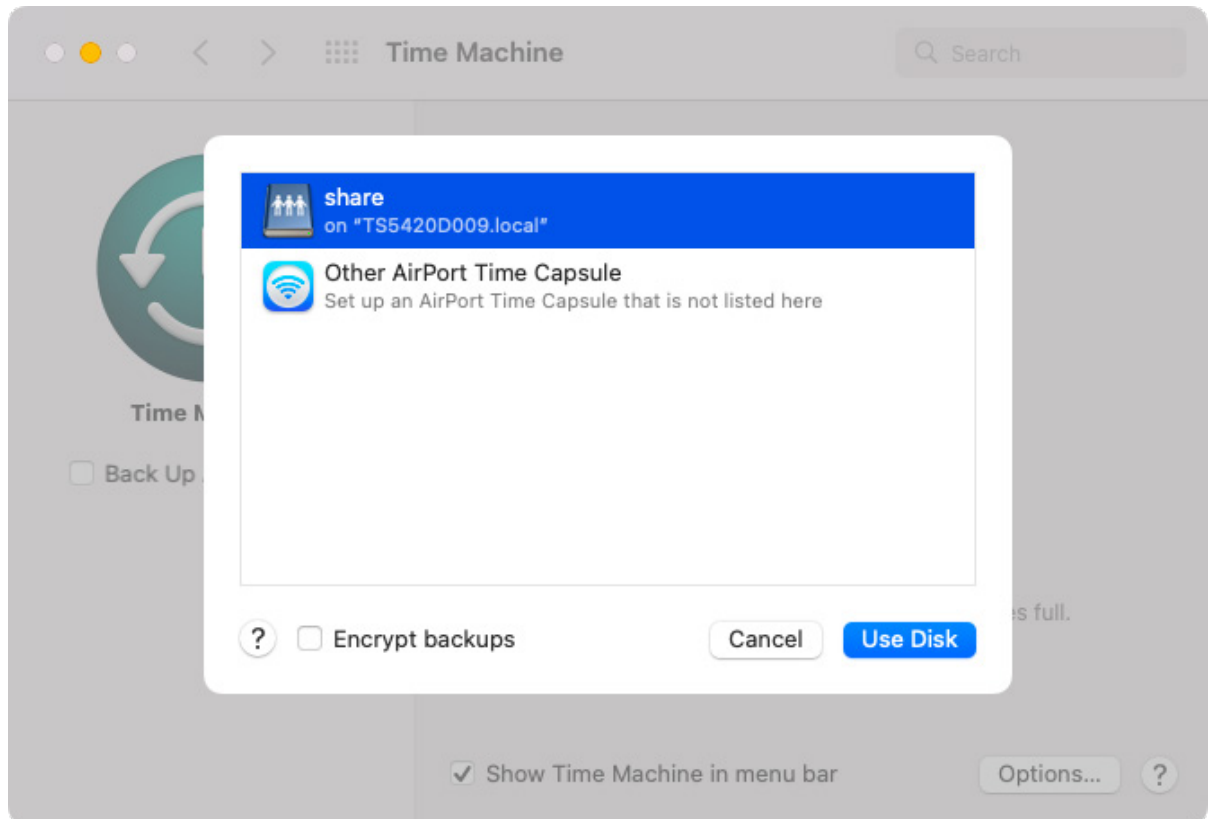

**5** Click *Connect*.

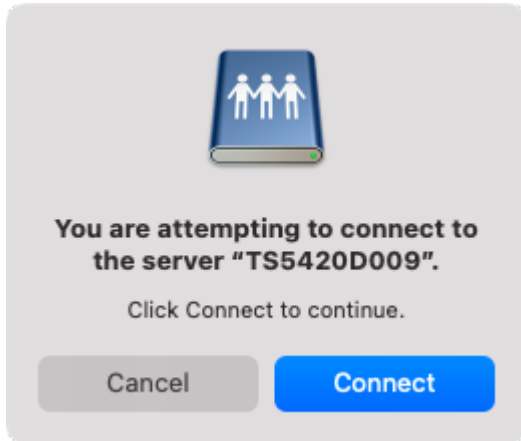

**6** Enter a username and password to be used for accessing the shared folder and click *Connect*.

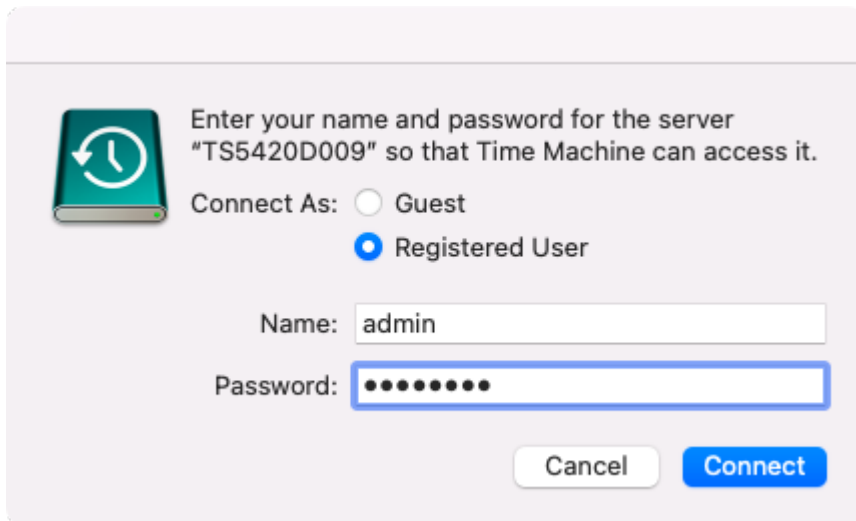

**Note:** If access restrictions are not configured on the destination share, log in using the administrator account. The default username and password for the administrator account are “admin” and “password”. If access restrictions are configured, log in using an account with write privileges.

**7** Time Machine will count down from 120 seconds, then backup will begin.

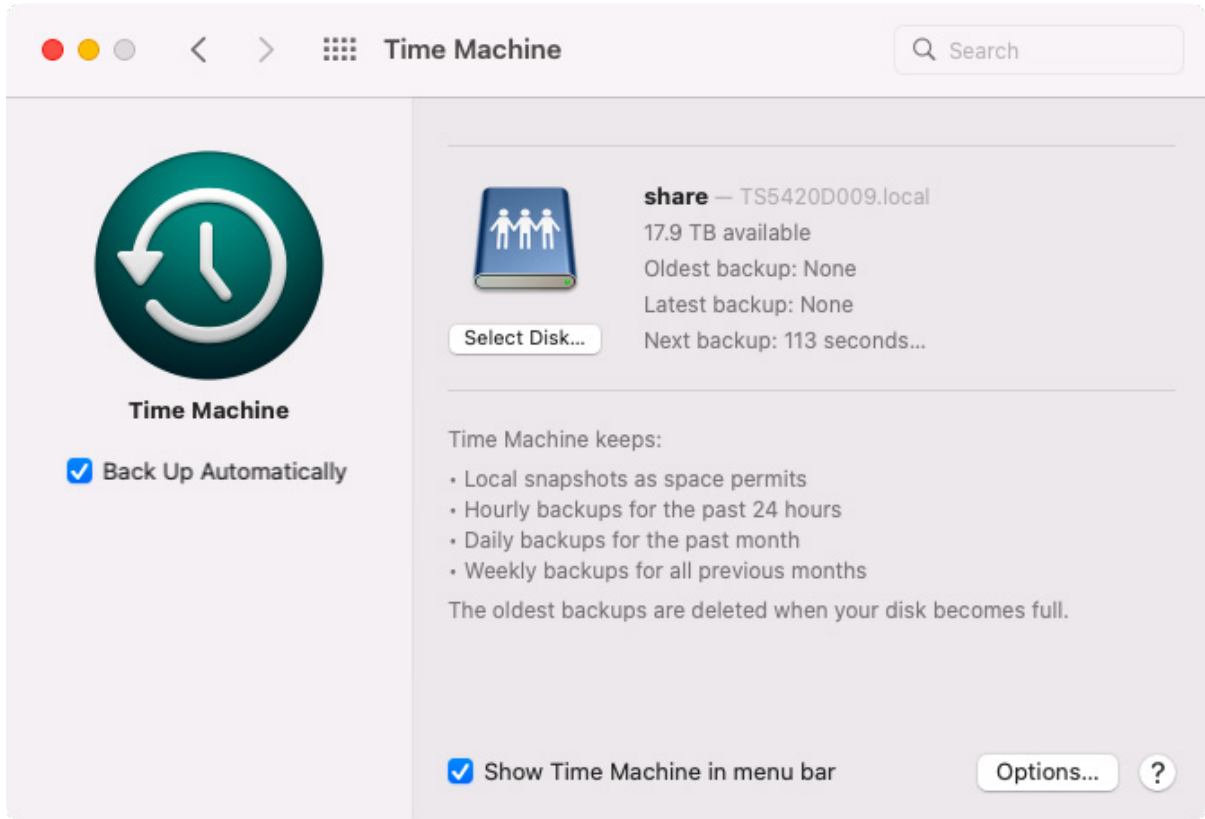

# Chapter 6 Cloud Services and Remote Access

## Synchronizing with Amazon S3

The TeraStation supports Amazon S3, a fee-based online storage service provided by Amazon, and other cloud storage services that share the Amazon S3 API. Follow the procedure below to configure your TeraStation for use with Amazon S3.

### Notes:

- Depending on the services you have purchased, prices for operations and amount of data will vary. To avoid being charged unexpectedly expensive fees, we recommend staying aware of the price structure for data storage and operations and regularly checking how much have been charged.
- Set the TeraStation's time settings to the correct time. Using NTP is recommended. To configure NTP settings on the TeraStation, refer to the ["Name, Date, Time, and Language"](#) section in chapter 10.
- If using Amazon S3 through a proxy server, click *Proxy Settings* and select whether to use the configured settings or configure an identical proxy server. If using the identical proxy server, select "New settings" and enter the proxy server name, port number, username, and password. Consult your network administrator for detailed proxy server settings.
- This function doesn't support Amazon S3 Glacier or S3 Object Lock.

## Creating an Amazon S3 Job

Follow the procedure below to create a new job.

- 1** From the Amazon S3 portal, create your Amazon S3 account and a bucket before proceeding with the procedure.
- 2** From Settings, click *Cloud Storage*.

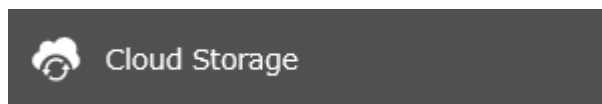

- 3** Click the settings icon (  ) to the right of "Amazon S3".

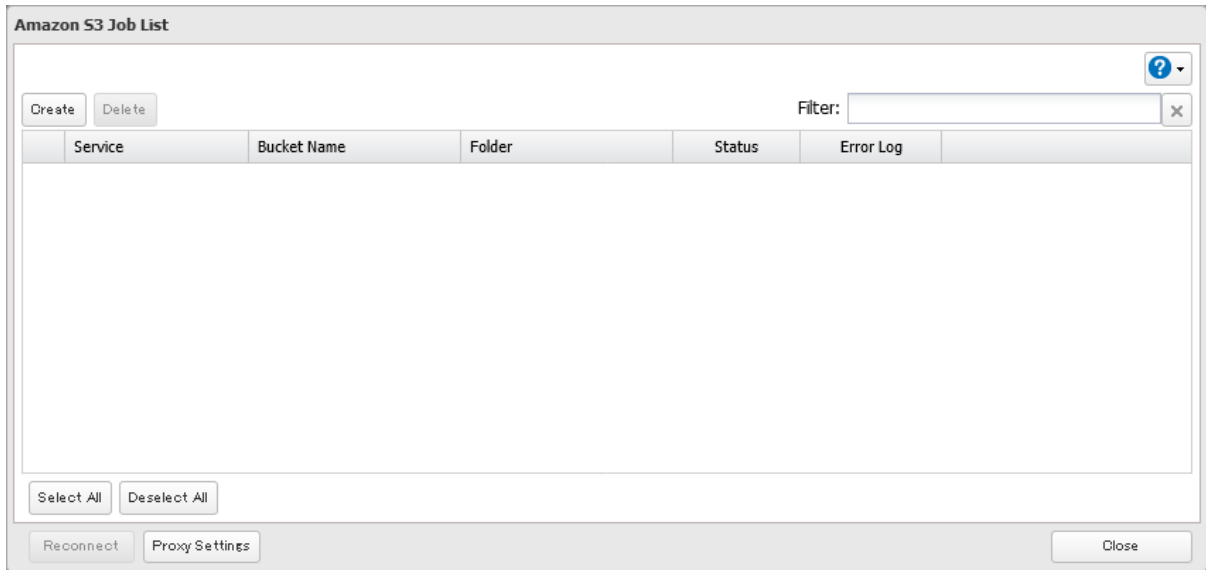
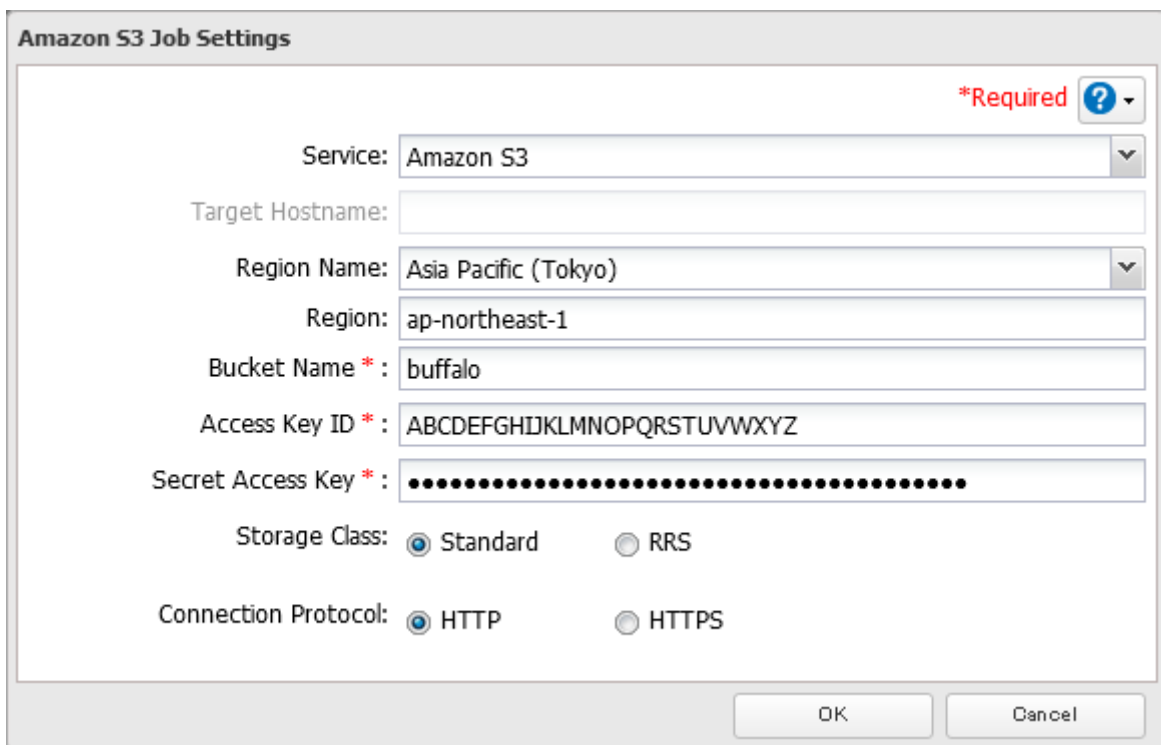

**4** Click *Create*.**5** Select the service name and region name that you have selected when creating the bucket from the drop-down list. Enter the bucket name, access key ID, and secret access key; select the storage class and the connection protocol, then click *OK*.

- 6** Enter a remote folder name to use with Amazon S3 and click *OK*.

- 7** Under “LAN Protocol Support”, select the “Backup” checkbox on the *Basic* tab.

- 8** Click *OK*.

- 9** Enter the desired characters into the backup device access key field and click *OK*.

- 10** Configure the desired shared folder settings, then click *OK*.

- 11** The process is complete once you close the confirmation window that appears.

**Notes:**

- If a remote folder created through this process is configured to use NFS, it cannot be mounted from an NFS client.
- Files cannot be uploaded to this remote folder using WebAccess.

- If you enter an incorrect bucket name and then cancel editing the Amazon S3 settings, the incorrect bucket name may still accidentally be registered. If this occurs, start from step 4 above and reconfigure the Amazon S3 settings correctly.
- Do not configure a folder that is created through the procedure above as a replication destination folder.

## Uploading Files to Amazon S3

To upload files to Amazon S3 buckets, using a backup job is recommended.

- 1 From Settings, click *Backup*.



- 2 Click the settings icon (  ) to the right of "Backup".



- 3 If you had configured a backup device access key for the remote folder that was created through the ["Creating an Amazon S3 Job"](#) section above, click *Set*. If you hadn't, skip to step 5.

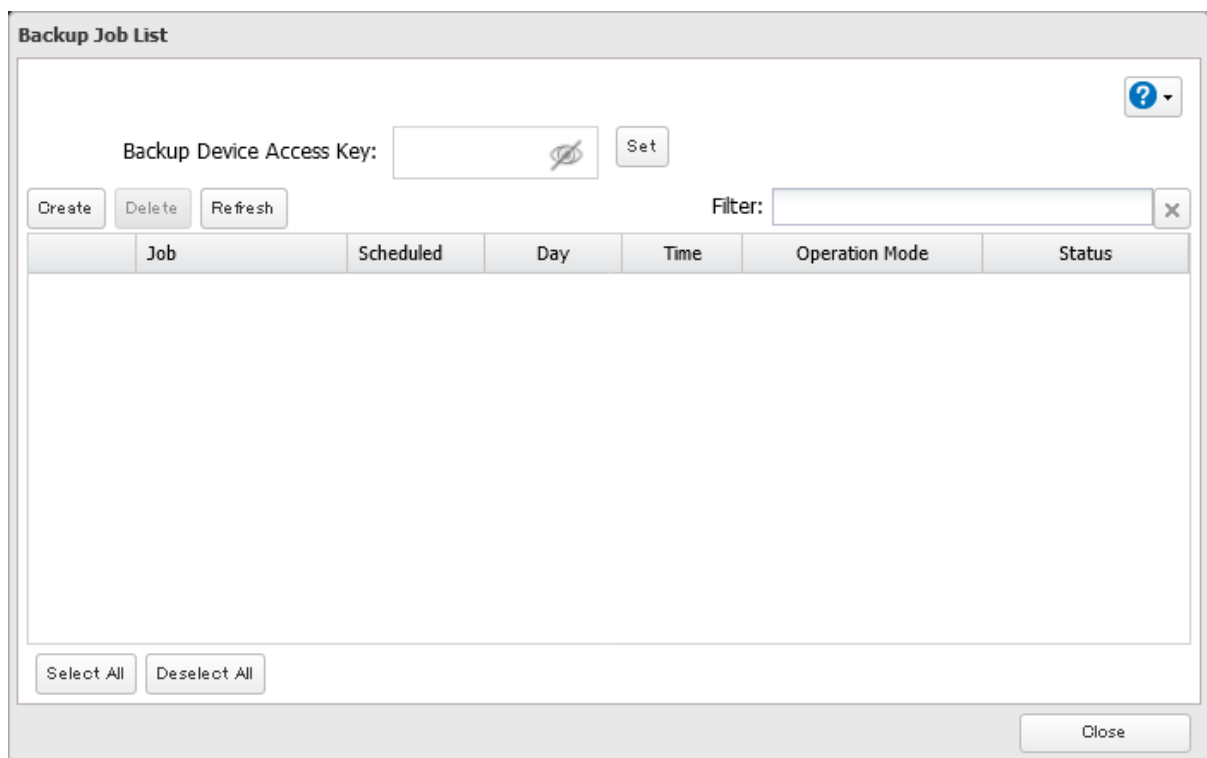

- 4 Enter the backup device access key and click *OK*.

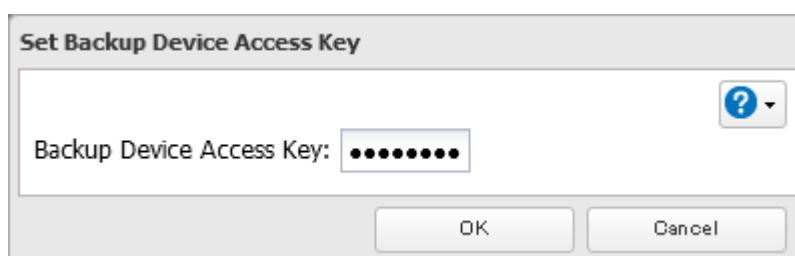

**5** Click *Create*.

The screenshot shows a window titled "Backup Job List". At the top right is a help icon (question mark in a blue circle). Below it is a "Backup Device Access Key:" label followed by a text input field containing "\*\*\*\*\*", a "Set" button, and a small icon of a crossed-out circle. Below this are three buttons: "Create", "Delete", and "Refresh". To the right is a "Filter:" label followed by a text input field and a close button (X). Below these is a table with the following headers: "Job", "Scheduled", "Day", "Time", "Operation Mode", and "Status". The table body is empty. At the bottom left are two buttons: "Select All" and "Deselect All". At the bottom right is a "Close" button.

**6** Select backup settings such as date and time to run, then select a backup mode for the "Operation Mode" drop-down list. It is recommended to configure a job to run periodically. Refer to the differences between the backup modes from the ["Backup Modes"](#) section in chapter 5.

**Note:** If you create a differential backup job and there are files that only exist in the destination folder, these files will be deleted when the job runs. Make sure that files are not saved when creating a backup job.

The screenshot shows the 'Backup Job Settings' dialog box. At the top, there is a title bar 'Backup Job Settings' and a '\*Required' label with a help icon. The 'Job Name' field contains 'job01'. The 'Schedule' is set to 'Not scheduled', 'Sunday', '00', and '00'. The 'Operation Mode' is 'Full backup'. The 'Versions' are set to '10' with the 'Unlimited' checkbox checked. Below this is an 'Options' section with several checkboxes: 'Create a subfolder for backup' (checked), 'Create backup log file' (checked), 'Save backup logs in the backup source folder' (selected), 'Select the folder to save backup logs' (unselected), 'Target Folder:' with a 'Browse' button, 'Encrypted data transfer' (unchecked), 'Compress and transfer' (unchecked), 'Ignore backup errors and continue backup job on schedule' (checked), 'Do not back up recycle bin' (unchecked), 'Overwrite unchanged files' (unchecked), 'Inherit subfolders' access restrictions' (unchecked), and 'Back up all snapshots' (unchecked). At the bottom right are 'OK' and 'Cancel' buttons.

**7** Click *Add*.

- 8** Select the shared folder that files will be saved to as a source, and the remote folder created through the [“Creating an Amazon S3 Job”](#) section above as a destination.

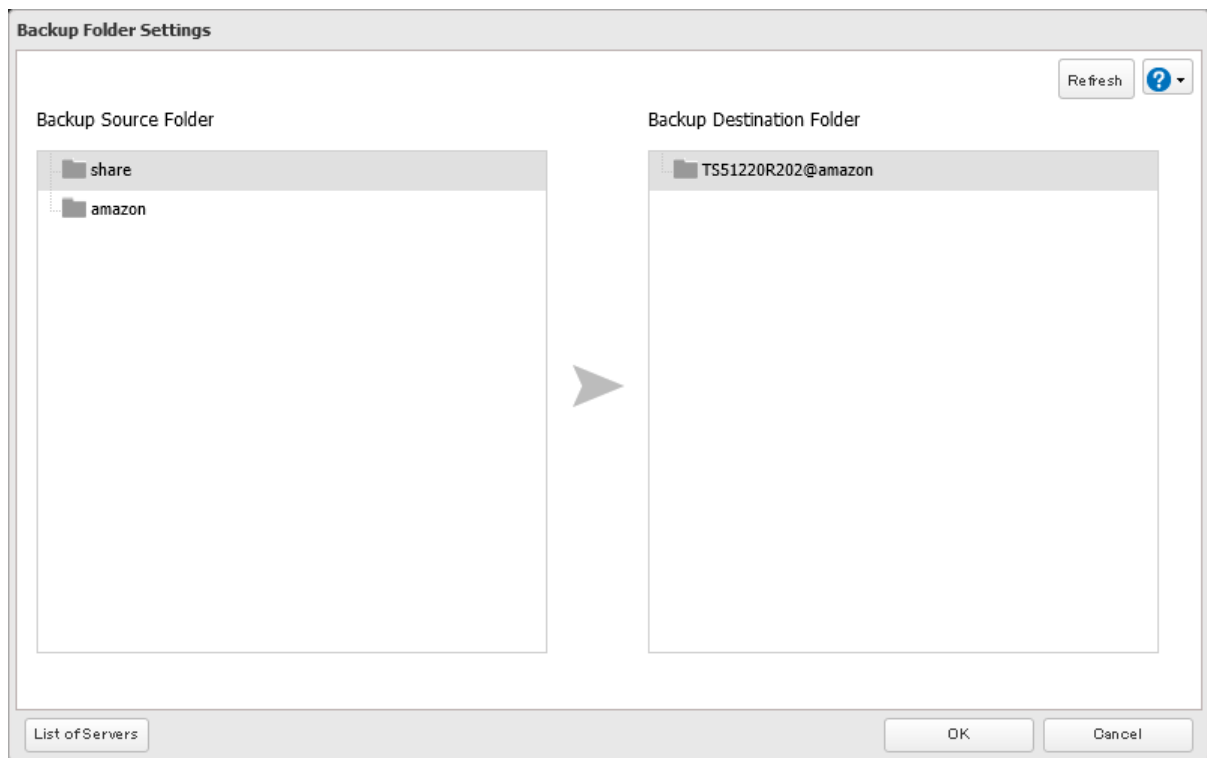

- 9** Click *OK*, then click *OK* again.

- 10** The process is complete once you close the confirmation window that appears. The backup job will be added to the backup jobs list.

**Notes:**

- To use the service after the network was temporarily disconnected, click *Reconnect*.
- If a file is directly added to the Amazon S3 bucket, the file will not be replicated to the remote folder.
- Do not copy 100,000 or more files to the backup source folder at once. If you do and uploading fails, check the network environment speed and try again with fewer files.
- Be careful with existing files in the remote folder, as files with the same name will be overwritten even if copied files are older.
- If you copy a file to the shared folder using File Explorer or a backup process, the file will also be uploaded sequentially to the Amazon S3 bucket. This second uploading process will start in the background during the first copying process and will not be visible. If the TeraStation is shut down or restarted immediately after copying a file to the shared folder, changing the settings, or disconnecting and reconnecting the Ethernet cable, the file may not be uploaded to the bucket. Try copying the file again if this occurs.
- If you encounter any upload or download errors, click *Error Log*. The log will display the filename and operation during which the error occurred.
- If uploading fails, try copying the file again. If it still fails, click *Reconnect* or set the Amazon S3 switch to off and on again, then restart the function service.
- If accessing or transferring files that total 1 TB or more to the Amazon S3 bucket, make sure there is enough free space on the TeraStation for temporary file caching. For example, when uploading 1 TB of files to the bucket, it is recommended to keep at least 2 TB of free space available.

## Synchronizing with Dropbox

The TeraStation supports synchronizing with Dropbox, the online cloud service. Once linked, you can share TeraStation files via Dropbox (or Dropbox files via TeraStation). Follow the procedure below to configure your TeraStation for use with Dropbox.

### Notes:



- To use Dropbox Sync, you will need a Dropbox account and an available empty Dropbox folder. If you don't have a Dropbox account, or if you need to create a new empty Dropbox folder, refer to the Dropbox website.
- If using Dropbox through a proxy server, click *Proxy Settings* and select whether to use the configured settings or configure an identical proxy server. If using the identical proxy server, select "New settings" and enter the proxy server name, port number, username, and password. Consult your network administrator for detailed proxy server settings.
- This function doesn't support linking with team folders.

## Creating a Dropbox Sync Job

Follow the procedure below to create a new job. Up to eight Dropbox jobs can be configured at a time.

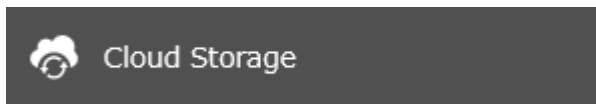
- 1 From Settings, click *Cloud Storage*.



- 2 Move the Dropbox Sync switch (  ) to the  position to enable Dropbox Sync.



- 3 Click the settings icon (  ) to the right of "Dropbox Sync".

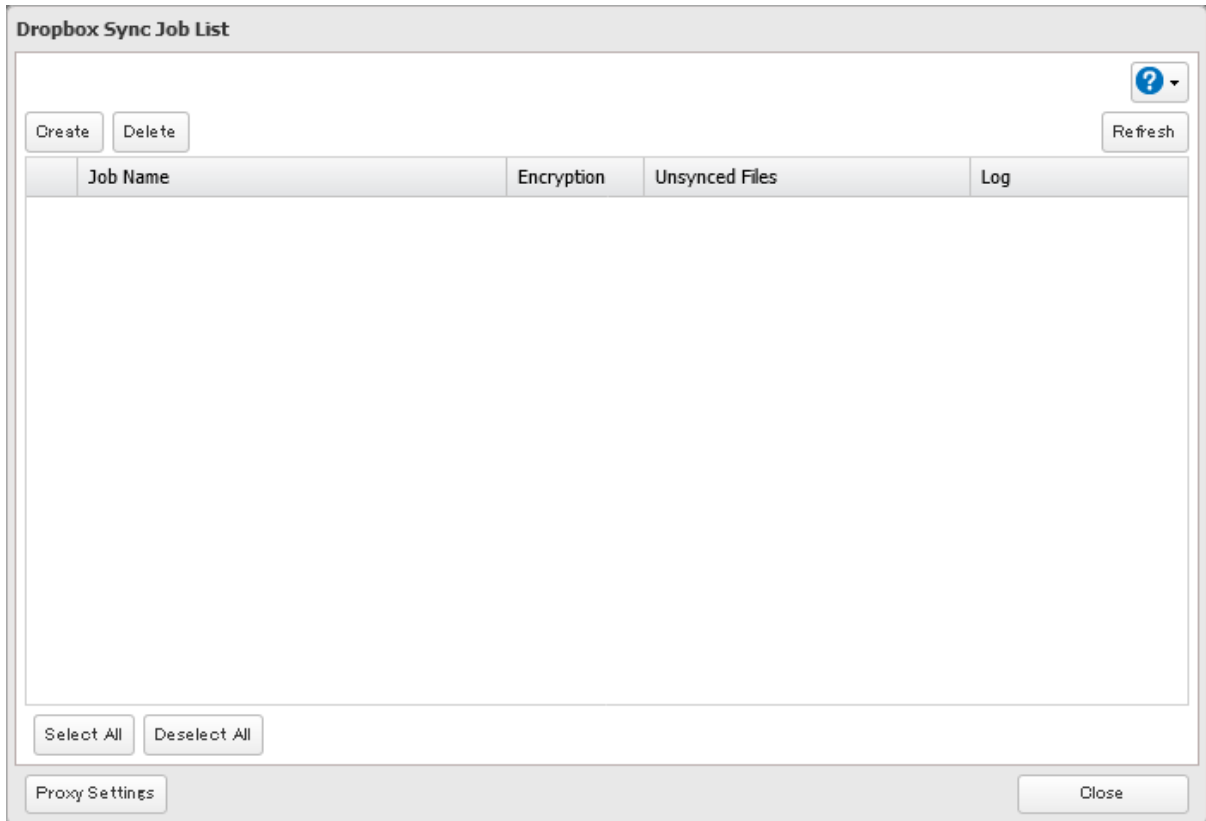
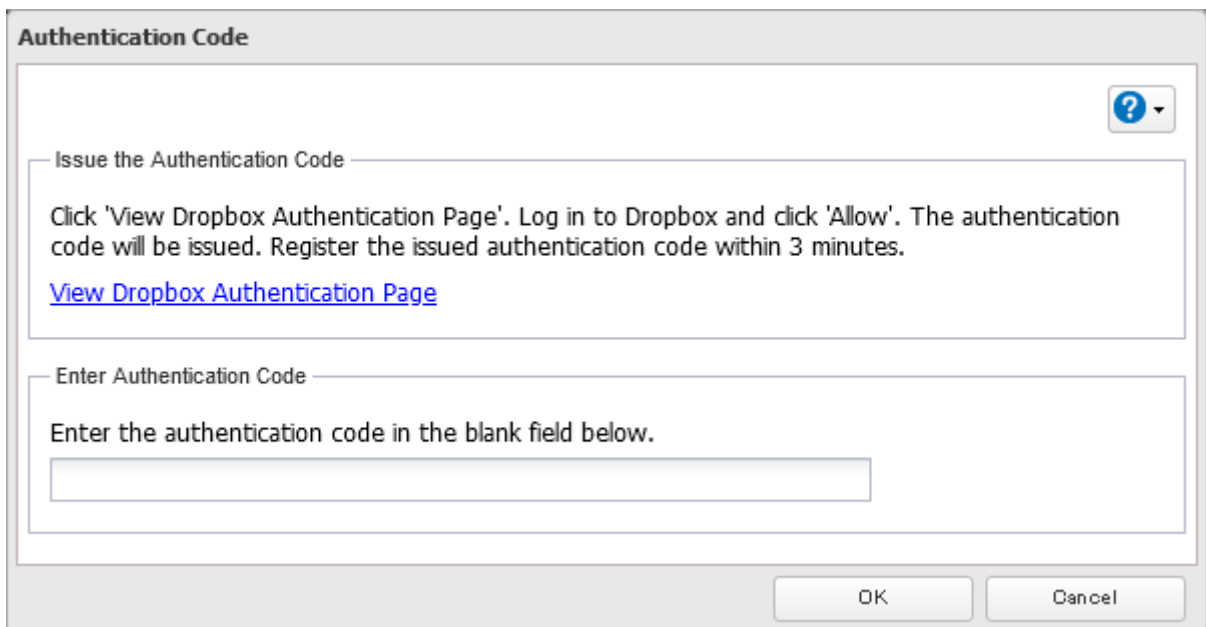

**4** Click *Create*.**5** Click *View Dropbox Authentication Page*.

**6** The authentication site that is offered by Dropbox will be displayed. Log in to the website with your Dropbox account, then click *Allow*.

**7** The authentication code will be displayed. Copy the authentication code and return to Settings. Authentication code reregistration should be finished within three minutes.

**8** Paste the authentication code and click *OK*.

**Authentication Code**

Issue the Authentication Code

Click 'View Dropbox Authentication Page'. Log in to Dropbox and click 'Allow'. The authentication code will be issued. Register the issued authentication code within 3 minutes.

[View Dropbox Authentication Page](#)

Enter Authentication Code

Enter the authentication code in the blank field below.

\*\*\*\*\*

OK Cancel

**9** Enter the desired job name; select the TeraStation and Dropbox folders, and configure encryption.

If you enable encryption, you will need to set an encryption password. The password cannot be changed once you configure it. Take note of the password and keep it secure. If you forget or lose the password, create a new job using the same Dropbox account, then delete the old job.

**Dropbox Sync Job Settings**

\*Required

Job Name \* : job01

Folder on TeraStation \* : share Browse

Folder on Dropbox \* : Dropbox/Dropbox\_share Browse

Encryption:  Enable  Disable

Encryption Password: [Greyed out field]

Setting a password with 10 or more characters is recommended.  
The encryption password cannot be changed once it's configured. Make sure to save and manage it carefully.

OK Cancel

**10** Click *OK*. The process is complete once you close the confirmation window that appears.

**Notes:**

- When encryption is enabled, files uploaded to Dropbox not using Dropbox Sync will not be downloaded to the TeraStation even if the sync direction is configured to "Bidirectional" or "Download only".
- Refer to the following website for synchronization restrictions between the TeraStation and Dropbox: <https://www.dropbox.com/help/145>
- Folders that are configured for Dropbox Sync cannot be renamed or used for replication.

- Files that are 900 MB or larger cannot be downloaded using Dropbox Sync. However, even if the file size is smaller than 900 MB, downloading may fail when multiple processes are running at the same time.

## Changing Job Settings

Follow the procedure below to change any job settings you have already configured.

- 1 From Settings, click *Cloud Storage*.



- 2 Click the settings icon (  ) to the right of "Dropbox Sync".



- 3 From the job list, click the job whose settings you want to change.

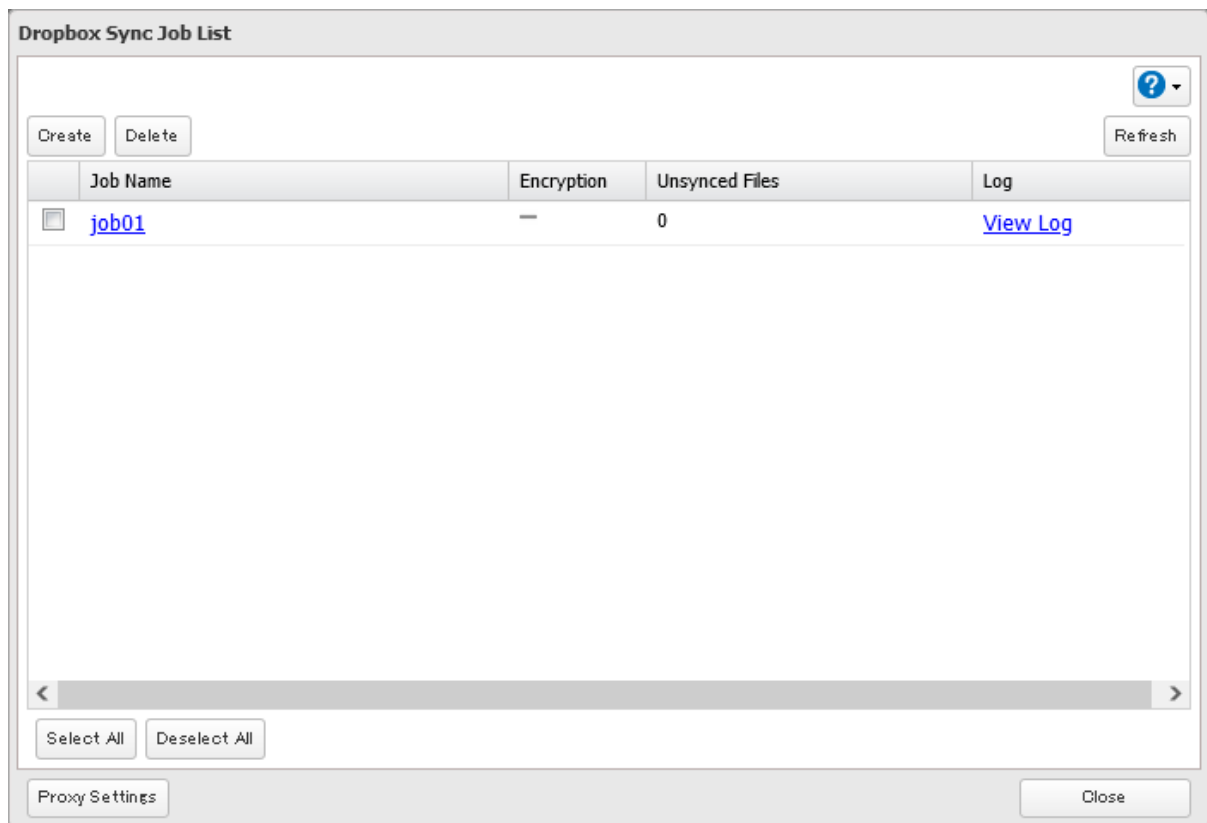

**4** Click the *Options* tab.

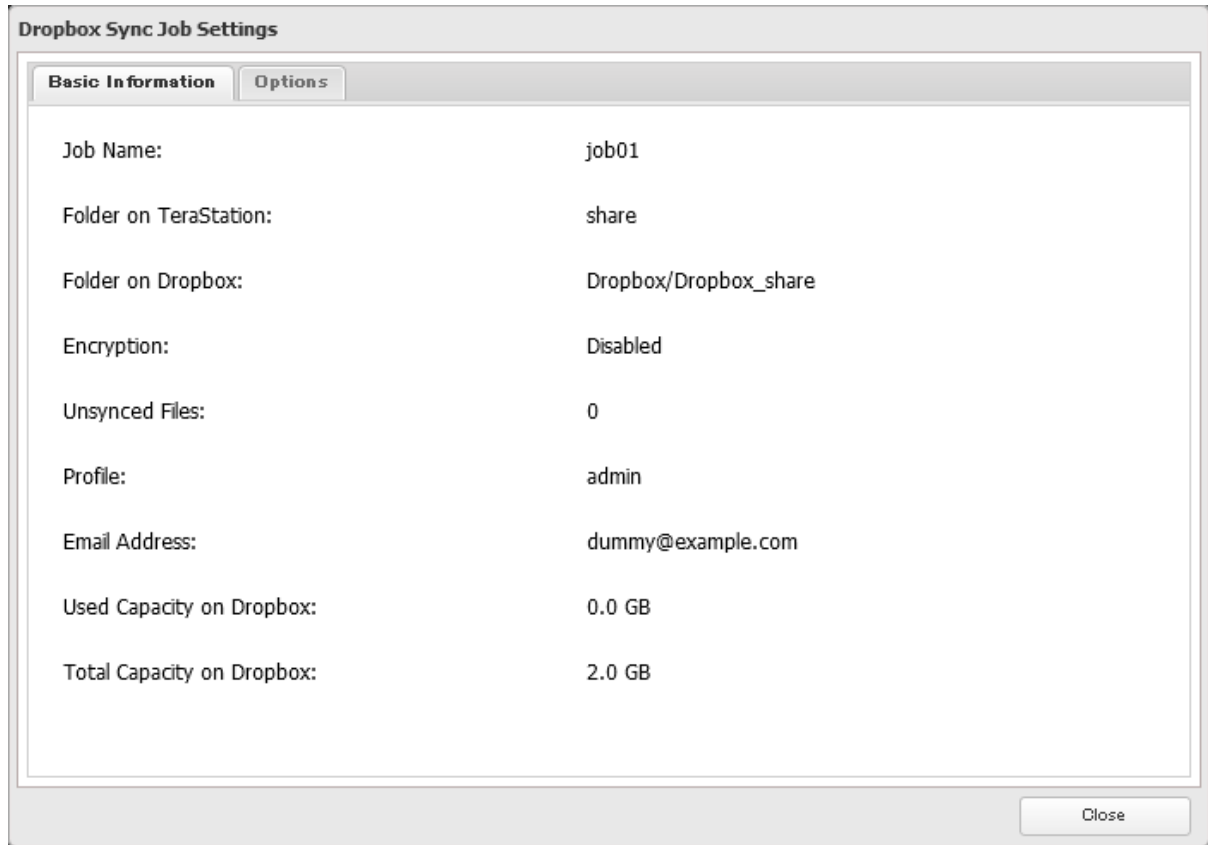

**5** Click *Edit*.

## 6 Configure the desired settings and click OK.

**Dropbox Sync Job Settings**

Sync Period: 5 minutes

Sync Direction: Bidirectional

Filter by File Size:  Enable  Disable

Maximum Size: 1 MB

Filtered Extensions:

Extensions

Filter Hidden Files:  Enable  Disable

## 7 The process is complete once you close the confirmation window that appears.

### Notes:

- When specific settings are changed, the changes will not be applied and the files on Dropbox may not be synchronized to the TeraStation. In such a case, delete the target files to be synchronized and upload them to Dropbox again or delete the job and recreate it again. The following are the specific circumstances for when files may not be synchronized:
  - Uploading or downloading fails.
  - File extensions are removed from filtering.
  - The sync direction is changed.
- “Hidden files” from the “Filter Hidden Files” option refer to files whose filename starts with a period.
- Regardless of whether file filtering was configured, the following files will not be uploaded to Dropbox:
  - desktop.ini
  - thumbs.db
  - Files whose filename contains the symbols / \ > < : " | ? \*
  - Files whose filename ends with either a space or period
  - Files whose filename starts with either ~\$ or .~
  - Files whose filename starts with ~ and have the file extension .tmp

## Creating a Shared Link (Windows Only)

Buffalo offers a Windows application, “B-Sync”, that can create shared links for the files stored in the TeraStation folders. You can download the application from the [Buffalo website](#). Refer to the application help for the usage procedure.

## Using Microsoft Azure for Data Preservation

The TeraStation supports synchronizing with Microsoft Azure, the online cloud storage service. Once linked, you can back up data on the TeraStation to Azure Storage, or restore data from Azure Storage to the TeraStation.

Microsoft Azure offers multiple types of storage and the TeraStation is compatible with blob storage. There are three types of blobs: block blobs, page blobs, and append blobs. The TeraStation only works with block blobs to store your data.

This feature is meant for situations such as disaster recovery and not a catch-all backup function. After linking the TeraStation and Microsoft Azure, data on the TeraStation will not be bidirectionally synchronized between the TeraStation and an Azure container.

### Notes:

- Depending on the services you have purchased, prices for operations and amount of data will vary. To avoid being charged unexpectedly expensive fees, we recommend staying aware of the price structure for data storage and operations and regularly checking how much have been charged.
- To access data that have been backed up to the container, use “Microsoft Azure Storage Explorer”.
- If using Azure Storage through a proxy server, click *Proxy Settings* and select whether to use the configured settings or configure an identical proxy server. If using the identical proxy server, select “New settings” and enter the proxy server name, port number, username, and password. Consult your network administrator for detailed proxy server settings.

## Creating an Azure Storage Sync Backup Job

Follow the procedure below to create a new backup job.

**1** From the Azure portal, create your Azure Storage account and a container before proceeding with the procedure.

**2** From Settings, click *Cloud Storage*.

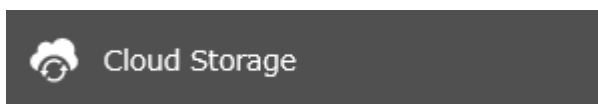

**3** Move the Microsoft Azure Storage Sync switch (  ) to the  position to enable Microsoft Azure Storage Sync.



**4** Click the settings icon (  ) to the right of “Microsoft Azure Storage Sync”.



**5** Click *Create*.

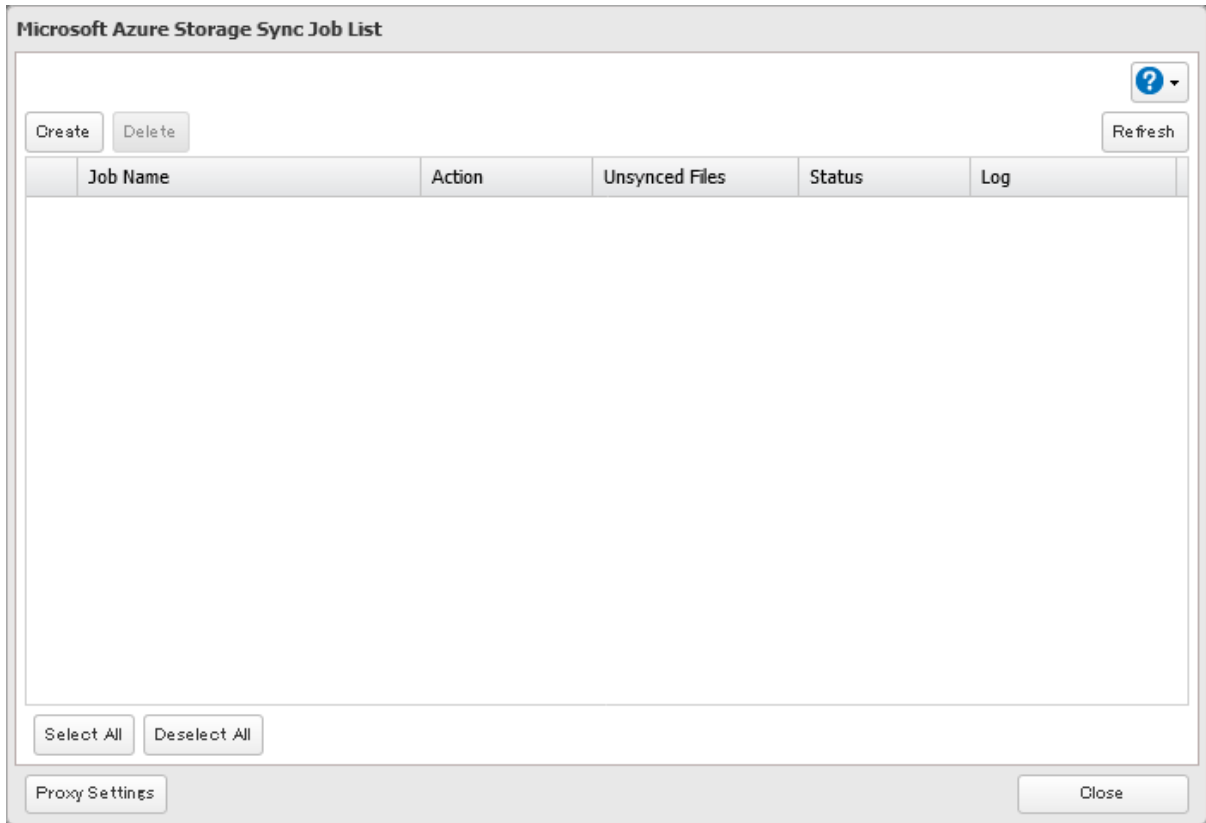

**6** The job setup wizard will open. Enter your Azure Storage account name and access key, then click *Next*.

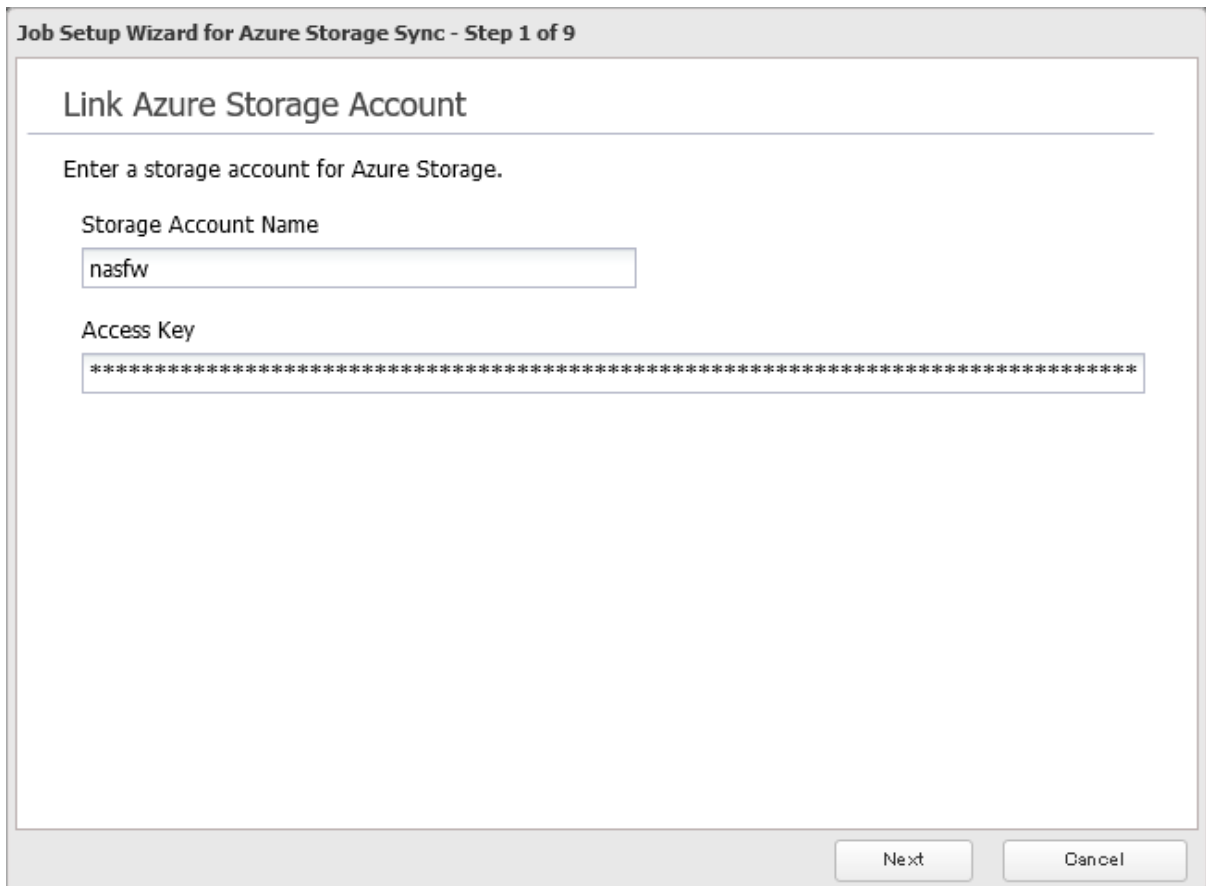

**7** Enter the desired job name and click *Next*.

**Job Setup Wizard for Azure Storage Sync - Step 2 of 9**

### Enter a Job Name

---

Enter a job name to create.

Job Name

Back Next Cancel

**8** Select "Backup" and click *Next*.

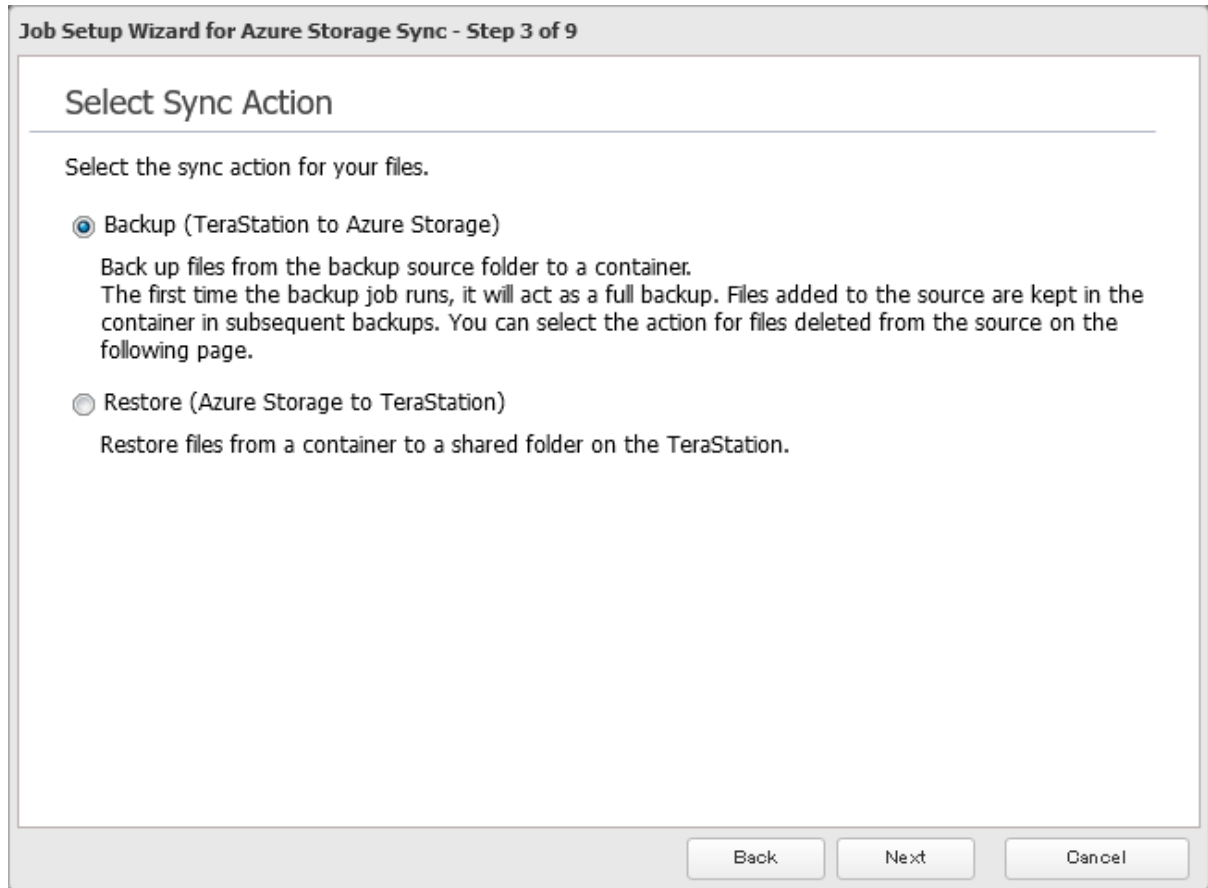

- 9 Select the desired shared folder on the TeraStation as the backup source folder. A TeraStation shared folder that is currently being used by certain TeraStation functions, including an existing Azure Storage sync job, cannot be selected.

**Job Setup Wizard for Azure Storage Sync - Step 4 of 9**

### Configure Job Pairs

Select the shared folder that contains desired files for backup as the backup source and enter a container name.

Backup Source Folder  
azure\_bk

Container Name  
test001

- 10 Enter the container name for the backup destination, then click *Next*.

**11** Specify the sync period and click *Next*.

**Job Setup Wizard for Azure Storage Sync - Step 5 of 9**

### Configure Sync Period

Select the interval of time between each backup.

Backup Interval

5 minutes

Back Next Cancel

- 12** Select the desired action to take for files in the container that share the same name as files in the backup source after they are deleted, then click *Next*.

**Job Setup Wizard for Azure Storage Sync - Step 6 of 9**

### Configure File Sync Action

Select the action to take for files in the backup destination container after deleting files with the same name from the backup source folder.

- Delete from container  
Delete the files from the backup destination container.
- Keep in container  
Keep the files as is in the backup destination container.

Back      Next      Cancel

- 13** Configure whether to filter the backup target files. The following screen is available to configure file filtering by file size and whether they're hidden. "Hidden files" refer to files whose filename starts with a period. Configure the desired filtering settings and click *Next*.

**Job Setup Wizard for Azure Storage Sync - Step 7 of 9**

### Configure File Filters 1

Configure the requirements for filtering files. If any files in the backup source folder meet any of the following requirements, those files will not be backed up.

**Filter by File Size**

Enable  Disable

Maximum Size:  MB

**Filter Hidden Files**

Enable  Disable

Back Next Cancel

- 14** The following screen is available to configure file filtering by extensions. Configure the desired filtering settings and click *Next*.

**Job Setup Wizard for Azure Storage Sync - Step 8 of 9**

### Configure File Filters 2

Configure the requirements for filtering files. If any files in the backup source folder meet any of the following requirements, those files will not be backed up.

**Filter by Extensions**

Enable  Disable

**Filtered Extensions**

Extensions

Add

Delete

Back Next Cancel

- 15** Confirm that all settings are properly configured and click *OK*.

- 16** The process is complete once you close the confirmation window that appears.

**Notes:**

- Regardless of whether file filtering was configured, the following files will not be backed up to an Azure Storage container:
  - desktop.ini
  - thumbs.db
  - Files whose filename contains the symbols / \ > < : " | ? \*
  - Files whose filename ends with either a space or period
  - Files whose filename starts with either ~\$ or .~
  - Files whose filename starts with ~ and have the file extension .tmp
- Do not copy files that are 10 GB or larger, and do not copy 100,000 or more files to the backup source folder at once. If you do and backup fails, check the network environment speed and try again with fewer or smaller files.

## Creating an Azure Storage Sync Restore Job

Follow the procedure below to create a new restore job.

- 1** From the Azure portal, create your Azure Storage account and a container before beginning the following procedure.

**2** From Settings, click *Cloud Storage*.



**3** Move the Microsoft Azure Storage Sync switch (  ) to the  position to enable Microsoft Azure Storage Sync.



**4** Click the settings icon (  ) to the right of "Microsoft Azure Storage Sync".

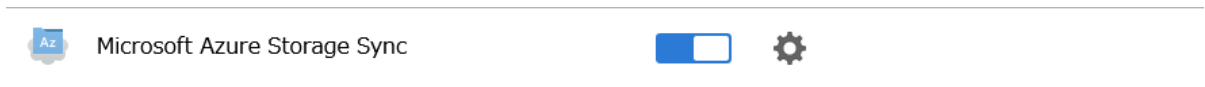

**5** Click *Create*.

The screenshot shows a window titled "Microsoft Azure Storage Sync Job List". At the top right is a help icon (question mark in a blue circle) with a dropdown arrow. Below it are "Create" and "Delete" buttons on the left, and a "Refresh" button on the right. The main area is a table with the following headers: "Job Name", "Action", "Unsynced Files", "Status", and "Log". The table body is currently empty. At the bottom left are "Select All" and "Deselect All" buttons. At the bottom right is a "Close" button. A "Proxy Settings" button is located at the bottom left of the window frame.

**6** The job setup wizard will open. Enter your Azure Storage account name and access key, then click *Next*.

**Job Setup Wizard for Azure Storage Sync - Step 1 of 9**

### Link Azure Storage Account

Enter a storage account for Azure Storage.

Storage Account Name

Access Key

Next Cancel

**7** Enter the desired job name and click *Next*.

**Job Setup Wizard for Azure Storage Sync - Step 2 of 9**

### Enter a Job Name

---

Enter a job name to create.

Job Name

**8** Select “Restore” and click *Next*.

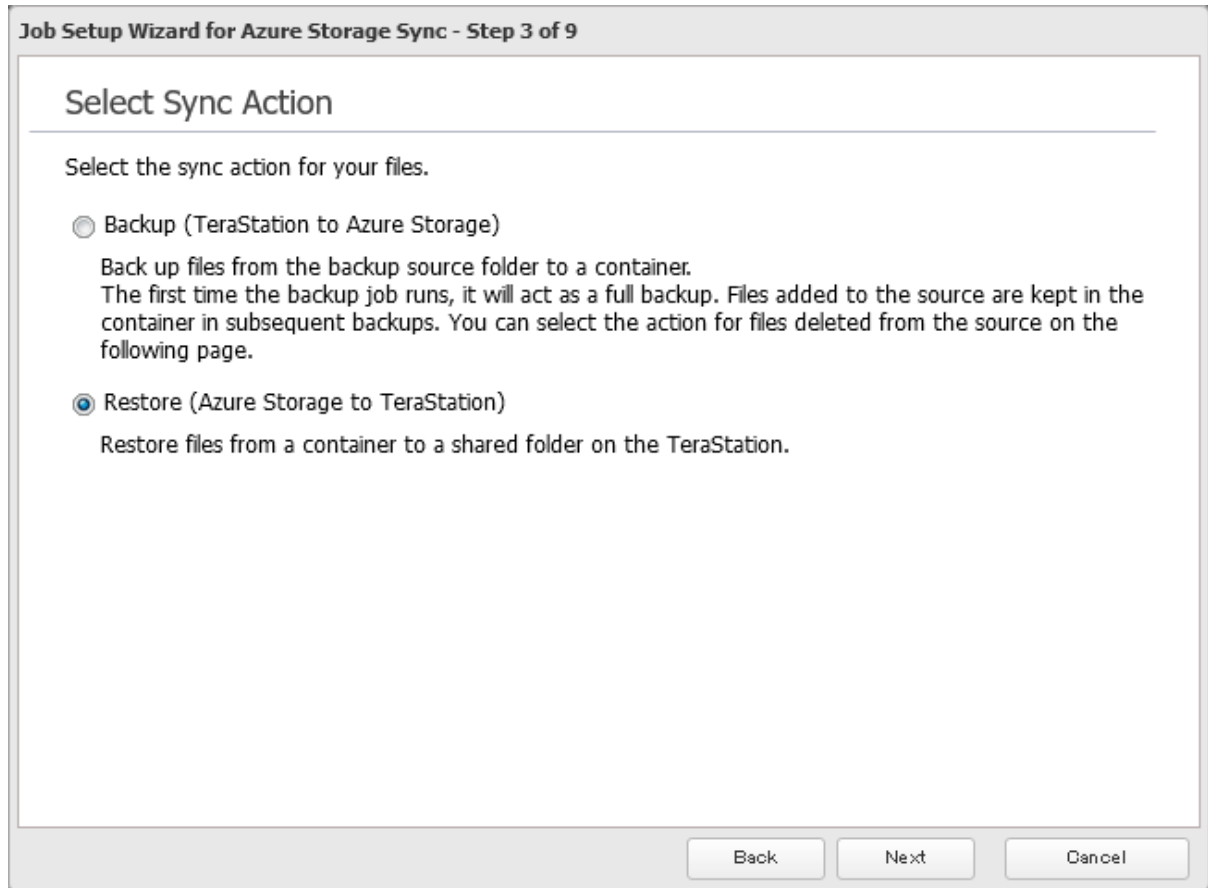

- 9 Enter the container name for the restore source and select the desired shared folder on the TeraStation as the restore destination, then click *Next*.

- 10 Select either to restore data into the first level folder (root folder) or the second level (subfolder) of the restore destination folder, then click *Next*.
- 11 Confirm that all settings are properly configured and click *OK*.
- 12 The process is complete once you close the confirmation window that appears.

**Note:** When deleting a finished restore job, it can be converted to a backup job. If that restore job had been configured to restore to the second level of the shared folder, restored data will automatically be moved to the first level. If there are files with the same filename in the first level folder, those files will be overwritten.

## Changing Job Settings

Follow the procedure below to change any of the backup job settings you have already configured. Restore job settings cannot be changed.

- 1 From Settings, click *Cloud Storage*.

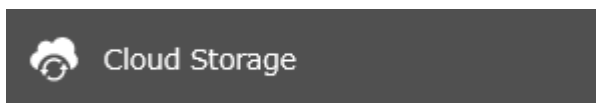

**2** Click the settings icon (  ) to the right of "Microsoft Azure Storage Sync".

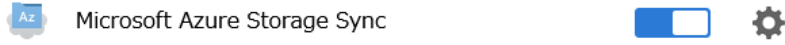

**3** From the job list, click the job whose settings you want to change.

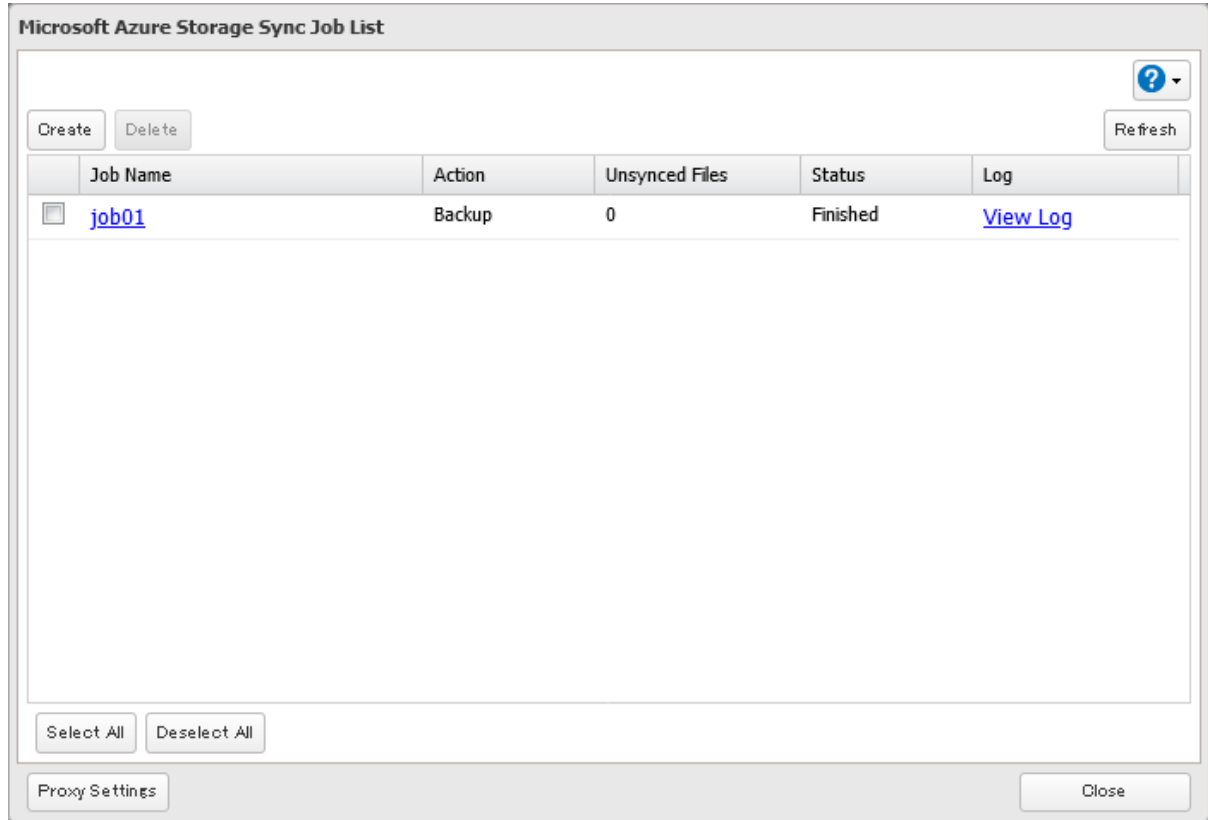

**4** Click the *Options* tab.

The screenshot shows a dialog box titled "Azure Storage Sync Job Settings". It has two tabs: "Basic" and "Options". The "Options" tab is selected. The dialog contains the following settings:

Storage Account Name:	nasfw
Job Name:	job01
Sync Action:	Backup
Files Deleted in Backup Source:	Delete from container
Backup Source Folder:	azure_bk
Container Name:	test001

A "Close" button is located in the bottom right corner of the dialog box.

**5** Click *Edit*.

## 6 Configure the desired settings and click OK.

**Azure Storage Sync Job Settings**

Backup Interval: 5 minutes

Filter by File Size:  Enable  Disable  
Maximum Size: 1 MB

Filter Hidden Files:  Enable  Disable

Filter by Extensions:  Enable  Disable

Filtered Extensions:

Extensions

OK Cancel

## 7 The process is complete once you close the confirmation window that appears.

## Synchronizing with Microsoft OneDrive

The TeraStation supports synchronizing with Microsoft OneDrive, the online cloud storage service. Once linked, you can share the TeraStation files via OneDrive (or OneDrive files via the TeraStation). Follow the procedure below to configure your TeraStation for use with Microsoft OneDrive.

### Notes:

- To use Microsoft OneDrive Sync, you need a Microsoft account and an available empty OneDrive folder. If you don't have a Microsoft account, or if you need to create a OneDrive folder, refer to the Microsoft website.
- If using OneDrive through a proxy server, click *Proxy Settings* and select whether to use the configured settings or configure an identical proxy server. If using the identical proxy server, select "New settings" and enter the proxy server name, port number, username, and password. Consult your network administrator for detailed proxy server settings.



## Creating a OneDrive Sync Job

Follow the procedure below to create a new job.

### 1 From the Microsoft portal, create your Microsoft account before proceeding with the procedure.

**2** From Settings, click *Cloud Storage*.



**3** Move the OneDrive Sync switch (  ) to the  position to enable OneDrive Sync.



**4** Click the settings icon (  ) to the right of "Microsoft OneDrive Sync".

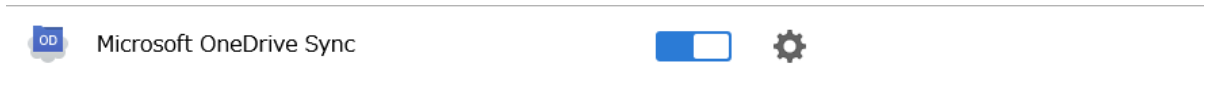

**5** Click *Create*.

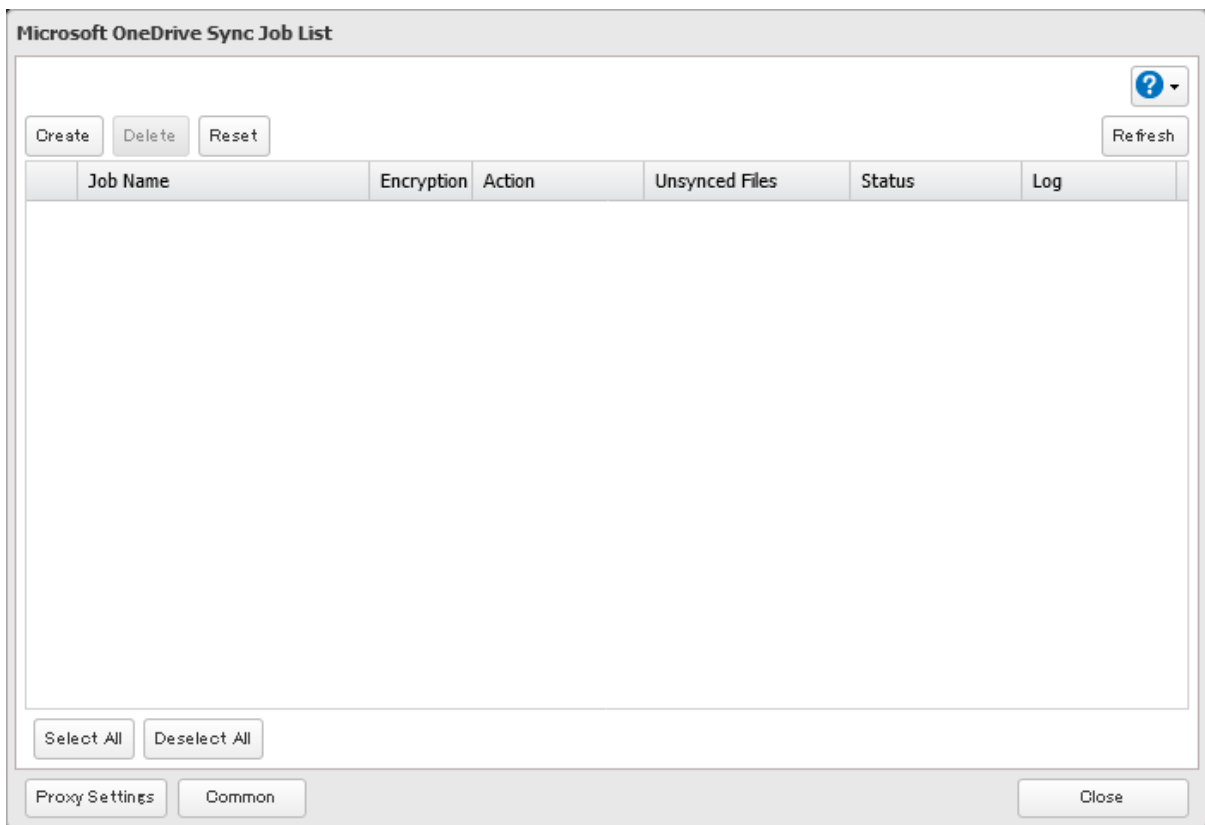

**6** The sign-in window will open. Enter the username and password of your Microsoft account, then sign in.

**7** Enter the desired job name and click *Next*.

Job Setup Wizard for OneDrive Sync - Step 1 of 10

### Enter a Job Name

---

Enter a job name to create.

 ?

**8** Select the sync action and behavior for when files with the same name are already in the target folder, then click *Next*.

There are three types of sync actions; bidirectional, uploading, and downloading. If bidirectional is selected as the sync action, files on both OneDrive and the TeraStation will be updated. If uploading is selected as the sync

action, only files on OneDrive will be updated. If downloading is selected as the sync action, only files on the TeraStation will be updated.

The behavior for when files with the same name already exist will occur when the files that have the same name on both the TeraStation and OneDrive are changed.

**Job Setup Wizard for OneDrive Sync - Step 2 of 10**

### Select Sync Action

Select the sync action for your files.

Bidirectional

**Files with Same Names**

- Keep files on OneDrive  
If there is a file conflict when syncing, files on OneDrive will be saved over other versions.
- Keep files on the TeraStation  
If there is a file conflict when syncing, files on the TeraStation will be saved over other versions.
- Keep files with newer modified date  
If there is a file conflict when syncing, files with the newer modified date will be saved over other versions.

Back Next Cancel

- 9 Select the desired TeraStation and OneDrive folders. A TeraStation shared folder that is currently being used by certain TeraStation functions, including an existing OneDrive Sync job, cannot be selected. If you want to create an empty folder first, click *Browse* under “Folder on TeraStation”, then click *Create Folder* on the selecting folder window that appears. Click *Next* after selecting the folders.

**Job Setup Wizard for OneDrive Sync - Step 3 of 10**

### Configure Job Pairs

Select the folders on OneDrive and the TeraStation that files will be synced each other.

Folder on TeraStation	onedrive	<input type="button" value="Browse"/>
Folder on OneDrive	OneDrive/Drive1	<input type="button" value="Browse"/>

**Note:** The sixth level and deeper of shared and OneDrive folders cannot be selected.

**10** Specify the sync period and click *Next*.

**Job Setup Wizard for OneDrive Sync - Step 4 of 10**

### Configure Sync Period

Select the interval of time between each synchronization.

5 minutes

Back Next Cancel

- Files will be uploaded during the start and end time of the period configured in step 9 above. If you want to always upload files during the configured sync period, select "Always sync within the sync period" for "Frequency". Click *Next* after configuring.

**Job Setup Wizard for OneDrive Sync - Step 5 of 10**

### Configure Schedule

Configure a schedule for a job. If you select "Daily" for frequency, specify the start and end time. If you select "Weekly" for frequency, specify the day of the week and times.

Frequency

Start Time

End Time

Day of Week  
 Sunday  Monday  Tuesday  Wednesday  Thursday  Friday  Saturday

- 12** Select whether to encrypt the files using a password. When encryption is enabled, uploaded files will be archived in zip format and encrypted using the entered encryption password. Click *Next* after selections are finished.

**Job Setup Wizard for OneDrive Sync - Step 6 of 10**

### Configure Encryption

Enable encryption for the files when uploading to OneDrive.

Enable  Disable

Encryption Password

Setting an encryption password with 10 or more characters is recommended. The encryption password cannot be changed once it's configured. Make sure to manage the password carefully after it has been saved.

Back Next Cancel

**Note:** If the password contains spaces or backslashes (\), decrypting a file on a computer may fail.

- 13** Configure file options. Select whether to check for file consistency and delete older files with the same name from OneDrive. Click *Next* after selections are finished.

**Job Setup Wizard for OneDrive Sync - Step 7 of 10**

### Configure File Options

**Consistency Check**  
Enable a consistency check. Files will be compared to a hash value between files on the source and destination folders for uploading/downloading. If there are any inconsistencies between files, the system will try syncing again.

Enable                       Disable

**Uploaded Files**  
Configure settings to delete old versions of files with the same name that have been uploaded onto OneDrive before an upload job starts to conserve space usage.

Delete old version                       Keep old version

Back      Next      Cancel

- 14** Configure whether to filter the target files. The following screen is available to configure file filtering by file sizes and whether they're hidden. The file size filtering will work only for the upload process. The available maximum size is up to 15,360 MB (15 GB). "Hidden files" refer to files whose filename starts with a period. Click *Next* after selections are finished.

**Job Setup Wizard for OneDrive Sync - Step 8 of 10**

### Configure File Filters 1

Configure the requirements for filtering files. If any files in the folder on either the TeraStation or OneDrive meet any of the following requirements, those files will not be synced.

**Filter by File Size**

Enable  Disable

Maximum Size:  MB

**Filter Hidden Files**

Enable  Disable

Back Next Cancel

- 15** The following screen is available to configure file filtering by extensions. Configure the desired filtering settings and click *Next*.

**Job Setup Wizard for OneDrive Sync - Step 9 of 10**

### Configure File Filters 2

Configure the requirements for filtering files. If any files in the folder on either the TeraStation or OneDrive meet any of the following requirements, those files will not be synced.

**Filter by Extensions**

Enable  Disable

**Filtered Extensions**

Filtered Extensions

Add

Delete

Back Next Cancel

- 16** Confirm that all settings are properly configured and click *OK*.

- 17** The process is complete once you close the confirmation window that appears.

**Notes:**

- Files whose filename contains the symbols " # % & \* / : > < ? \ } { ~ may fail to be synchronized. This symbol limitation is based on "Normalization Form Canonical Composition (NFC)". If synchronization fails, check whether these symbols are not included in the filename.  
If you copy files that contain these symbols to a TeraStation folder from macOS, the filenames may be converted to different ones that don't contain these symbols.
- Depending on your network environment, you may fail to download larger files. To prevent this issue, divide a larger file into smaller files or compress the files to a smaller size before uploading them to OneDrive.
- When files are uploaded from the TeraStation folder using OneDrive Sync and then downloaded onto a computer from OneDrive, time stamps for files may be changed to the download date.
- If there are nine or more jobs created, the TeraStation will re-arrange the number of concurrently-running jobs to reduce the load when synchronizing files.
- Do not copy 100,000 or more files to the TeraStation folder at once. If you do and synchronization fails, try again with fewer files.
- If a file's size is zero bytes, a sync error occurs and the file will not be synchronized. The I64 message will appear as a notification.
- If unexpected behaviors occur during file sync, such as some files not being synced, click *Reset* on the job list window. This will resync all files on the TeraStation and/or OneDrive the next time the sync process runs. The existing files will be overwritten, and files that will be resynced will vary depending on the sync action settings.

To start resyncing immediately after clicking *Reset*, change the frequency settings to “Always sync within the sync period” by referring the [“Changing Job Settings”](#) section below.

## Changing Job Settings

Follow the procedure below to change any job settings you have already configured.

- 1 From Settings, click *Cloud Storage*.



- 2 Click the settings icon (  ) to the right of “Microsoft OneDrive Sync”.

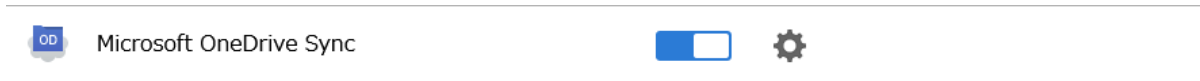

- 3 From the job list, click the job whose settings you want to change.

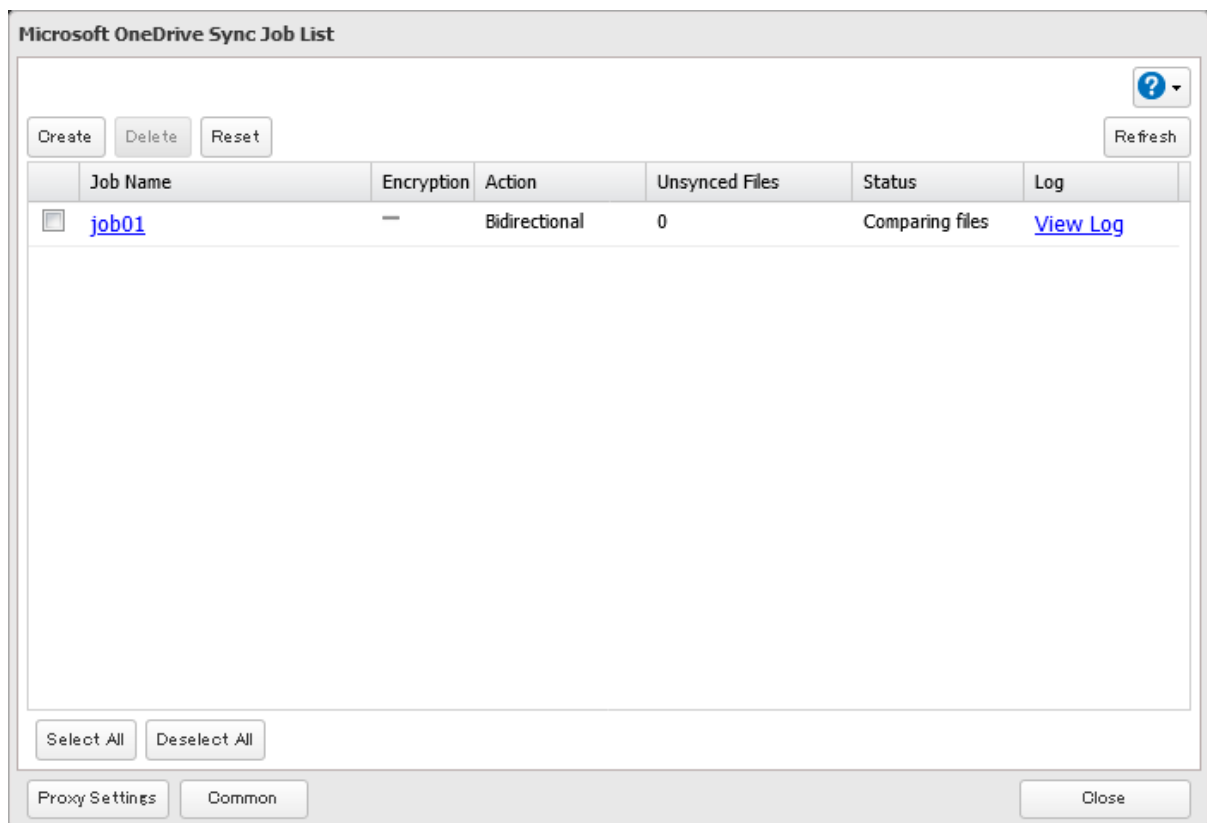

**4** Click the *Options* tab.

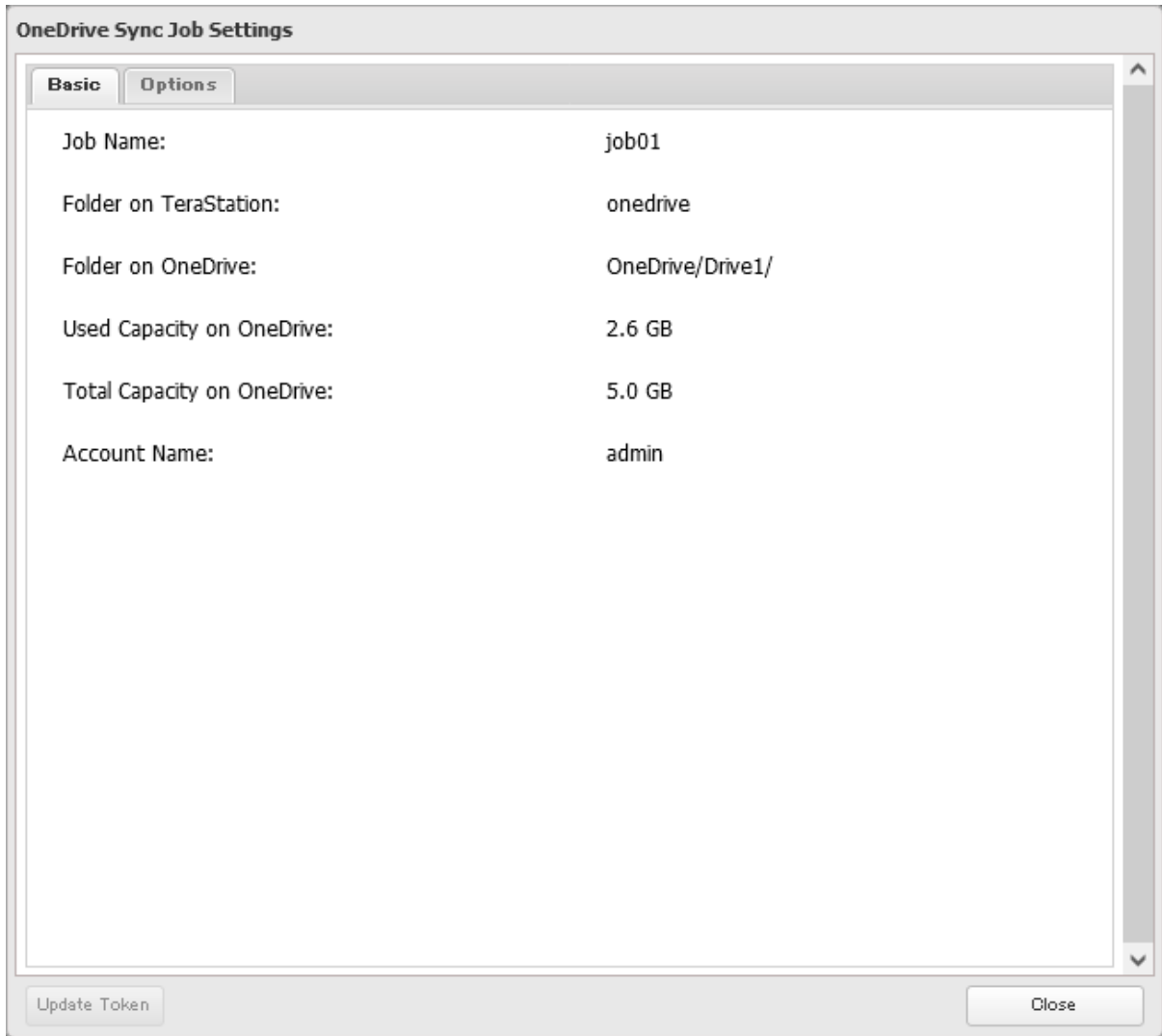

**5** Click *Edit*.

## 6 Configure the desired settings and click OK.

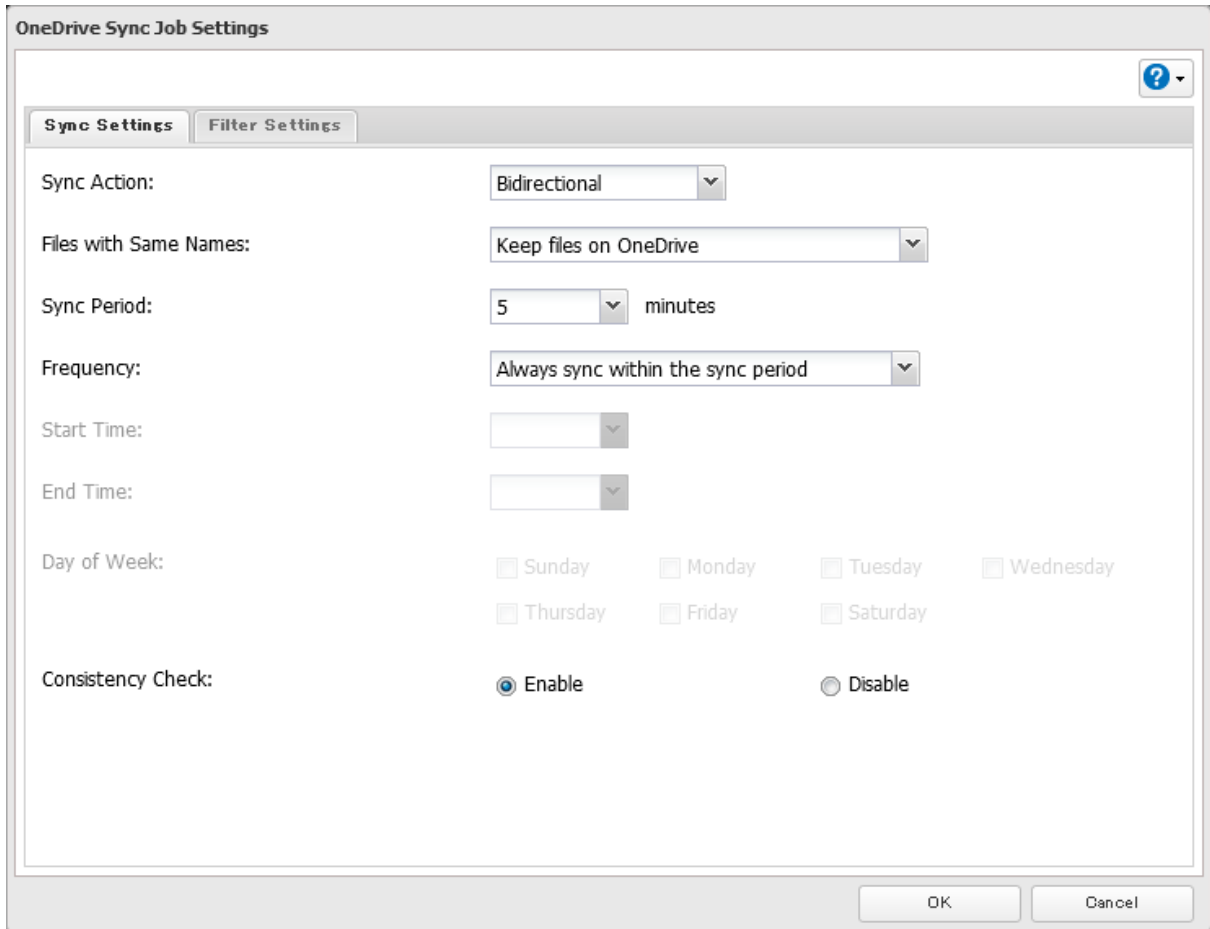

## 7 The process is complete once you close the confirmation window that appears.

## Corrective Actions for in Case of Error

### Error Appears in the “Status” Field of Job List

If a token error is displayed on the “Status” field of the OneDrive Sync job list, follow the procedure below to refresh the token.

#### 1 From Settings, click *Cloud Storage*.

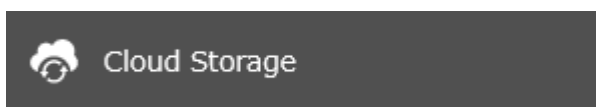

#### 2 Click the settings icon ( ) to the right of “Microsoft OneDrive Sync”.



**3** From the job list, click the job whose the token error occurs.

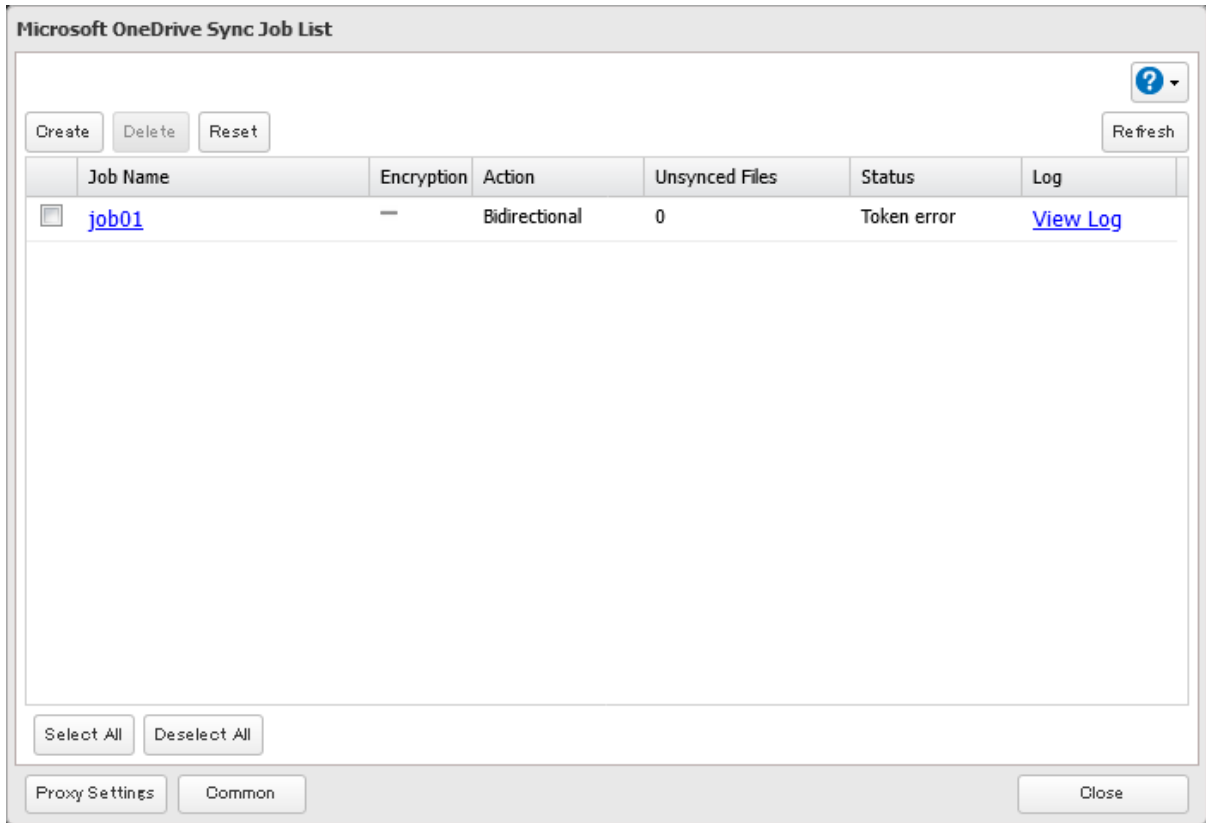

**4** Click *Update Token* at the bottom-left of the window.

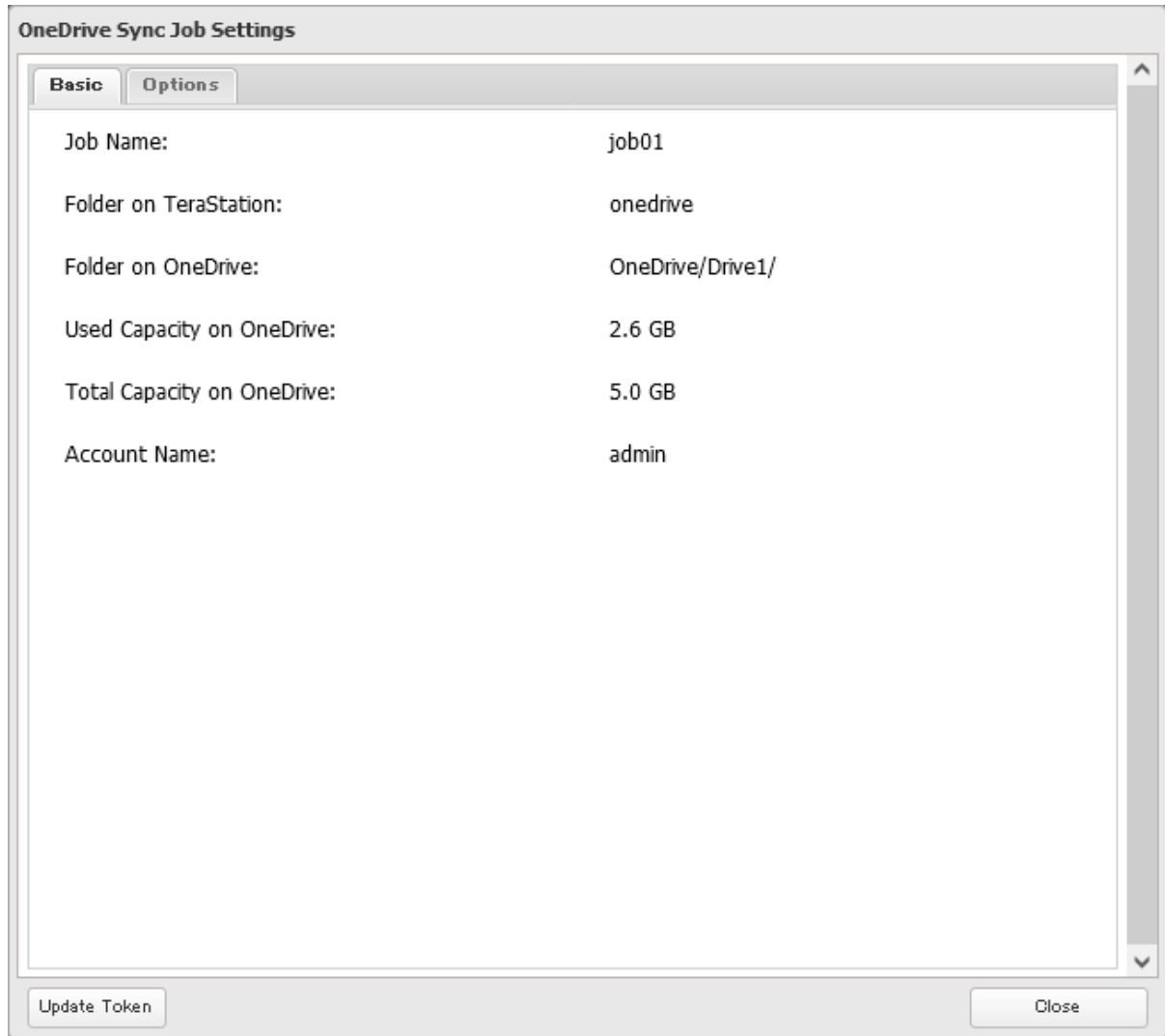

**5** The process is complete once you close the confirmation window that appears.

### Error Appears While Creating a Job or Error Code Appears on the Error Log

You may encounter error messages that contain the following error codes when creating OneDrive Sync jobs; the error log may contain the following error codes as well. If you encounter one of the following error codes, refer to the table below and try the respective corrective action. If the error code is not listed on the table, refer to the Microsoft website instead: <https://docs.microsoft.com/en-us/onedrive/developer/rest-api/concepts/errors?view=odsp-graph-online>.

Code	Description	Corrective Action
access_denied	Access denied for the requested information.	To link with OneDrive, please consent to the request from OneDrive.
server_error	The authentication server encountered a temporary error.	Please wait for about 10 minutes and try again.
temporarily_unavailable	The authentication server is too busy.	Please wait for about 10 minutes and try again.
authcode_notfound	The authentication server is too busy.	Please wait for about 10 minutes and try again.

Code	Description	Corrective Action
auth_server_error	The authentication server encountered a temporary error.	The authentication server will recover within UTC 12:00 midnight–8:45 a.m. (Mon–Fri). Please wait until it recovers.
auth_server_maintenance	The authentication server is currently undergoing maintenance.	Maintenance will finish within UTC 12:00 midnight–8:45 a.m. (Mon–Fri). Please wait until maintenance finishes.
activityLimitReached	There are too many requests so data could not be synchronized.	Check that the same Microsoft account is used on another Buffalo NAS device or Microsoft software. This error may be resolved by reducing the maximum number of threads per job on the window that appears by navigating to the job list and then clicking <i>Common</i> .
invalidRequest	A zero-byte file was going to be synchronized but failed.	Remove the zero-byte file and try again. If the I64 message persists on the Dashboard in Settings, click the “Clear” button to delete the message.
network_error	Could not register the authentication code.	Check that the network or proxy server settings are correct.
Unexpected error	Unknown error.	Please wait for about 10 minutes and try again.

## WebAccess

WebAccess is a software utility for accessing the files in the shared folder of your TeraStation from your computer or mobile devices through the Internet. **Be careful when configuring WebAccess. Certain settings can make the files in the shared folder available to anyone on the Internet, without any access restrictions.**

**Note:** WebAccess supports downloading up to 60,000 files at a time. Attempting to download 60,000 or more files at a time may result in unexpected behavior.

## Configuring WebAccess

- 1 From Settings, click *File Sharing*.

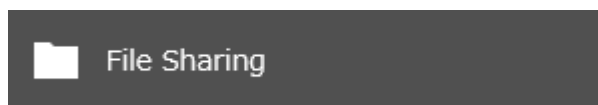

- 2 Click the settings icon (  ) to the right of “WebAccess”.



- 3 Click *Edit*.

#### 4 Configure the desired settings, then click *OK*.

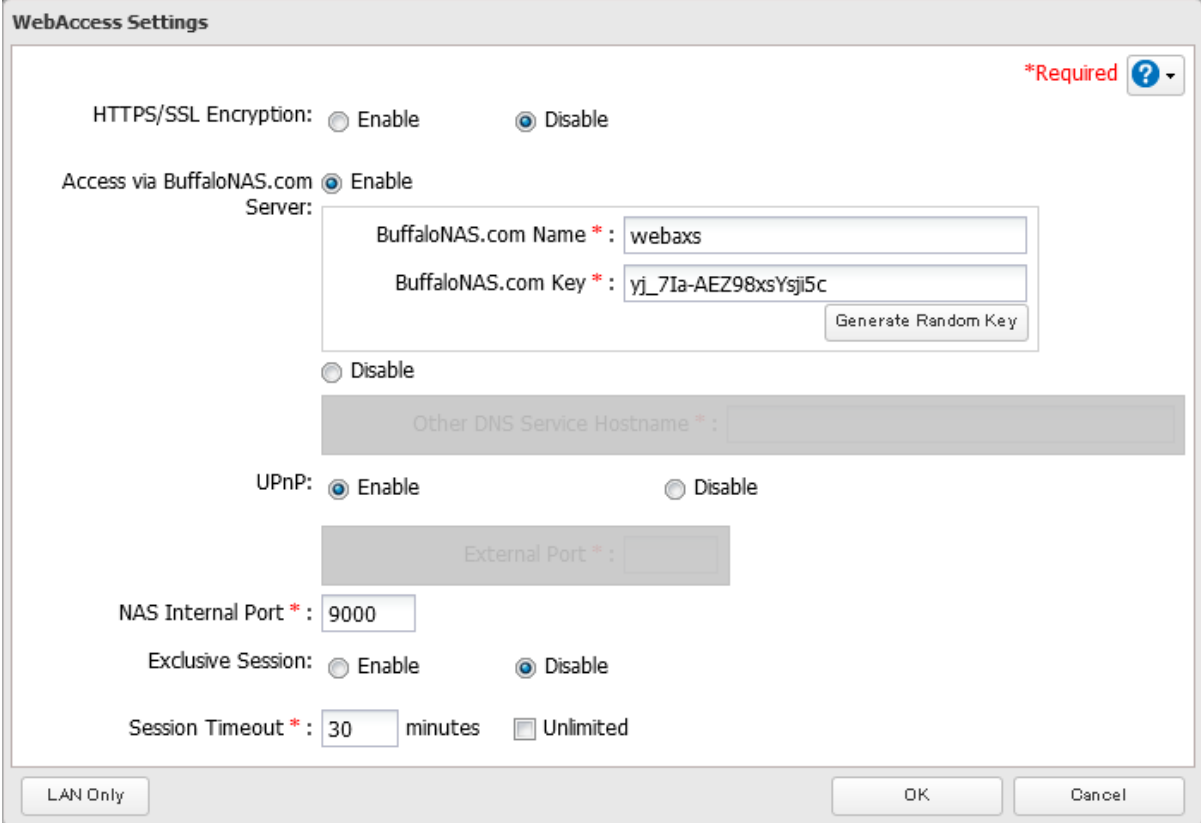

**WebAccess Settings** \*Required ?

HTTPS/SSL Encryption:  Enable  Disable

Access via BuffaloNAS.com  Enable

Server:

BuffaloNAS.com Name \* :

BuffaloNAS.com Key \* :

Disable

Other DNS Service Hostname \* :

UPnP:  Enable  Disable

External Port \* :

NAS Internal Port \* :

Exclusive Session:  Enable  Disable

Session Timeout \* :  minutes  Unlimited

- To use SSL encryption for more secure data transfers, enable “HTTPS/SSL Encryption”.
- You may use the BuffaloNAS.com server as a DNS server, or disable it to use a different DNS server.
- Choose a “BuffaloNAS.com Name” and “BuffaloNAS.com Key” for your WebAccess account. Names and keys may contain between 3 and 20 alphanumeric characters, underscores (\_), and hyphens (-).
- If “Exclusive Session” is enabled, multiple users cannot be logged in to WebAccess at the same time. Only the last login will be active.
- Enter a time in minutes (1 to 120, or “Unlimited”) before inactive users are logged out of WebAccess.

#### 5 Move the WebAccess switch ( ) to the position to enable WebAccess.



#### 6 Click the settings icon ( ) to the right of “Folder Setup”.



**7** Click *Create*.

For best results, create a new dedicated share for WebAccess to prevent opening files accidentally.

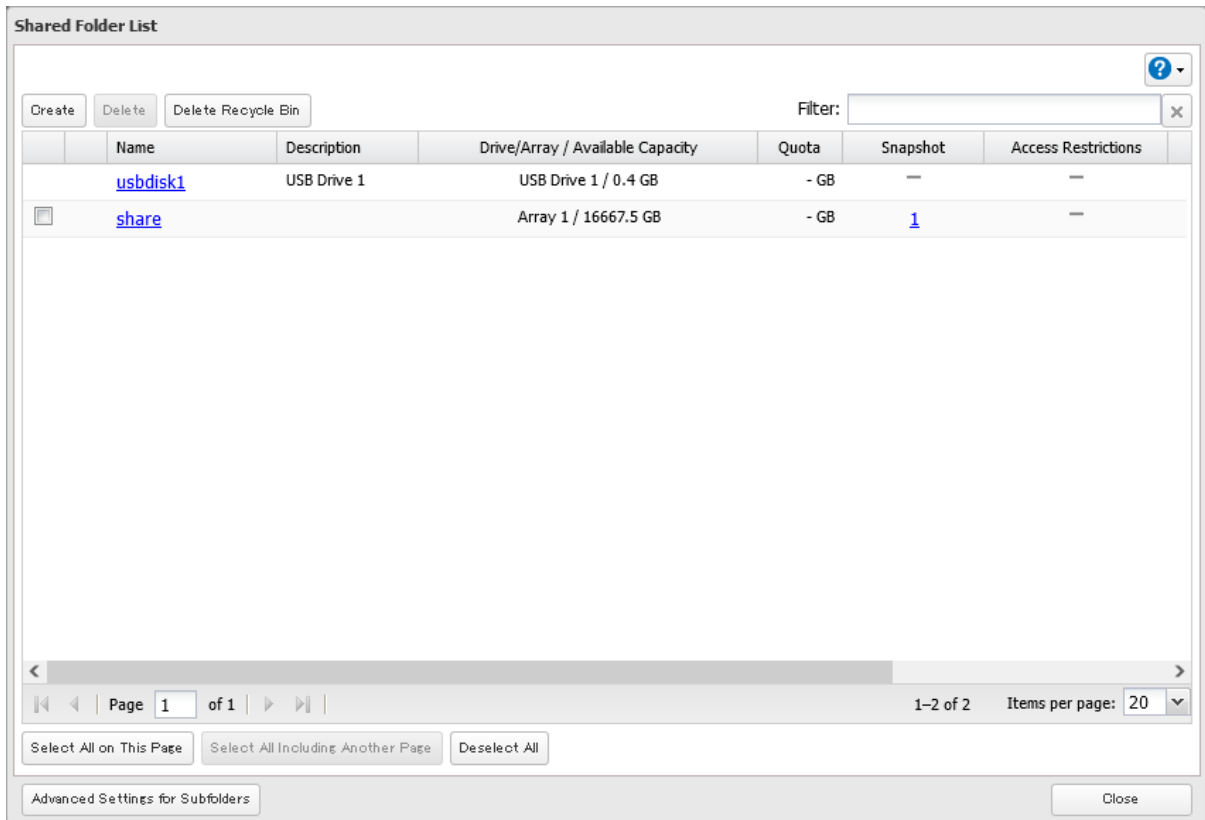
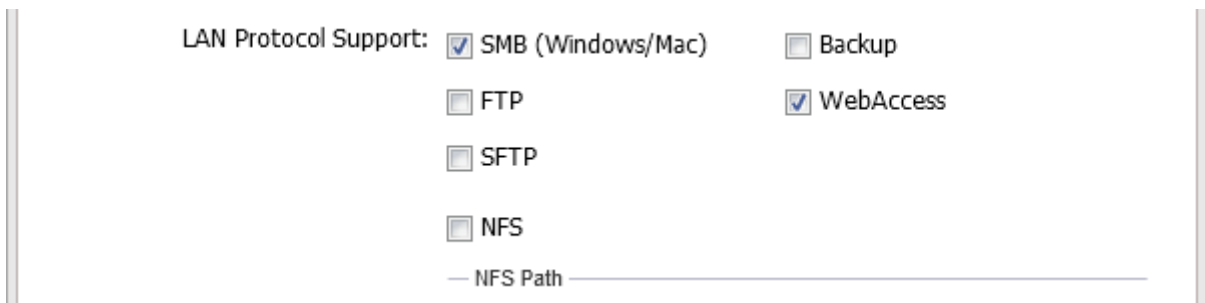
**8** Under “LAN Protocol Support”, select the “WebAccess” checkbox on the *Basic* tab.**9** Click the *Option 2* tab.

- 10** Select the desired WebAccess security level for “WebAccess Permissions”. For more detailed information about each WebAccess security level, refer to the note below.

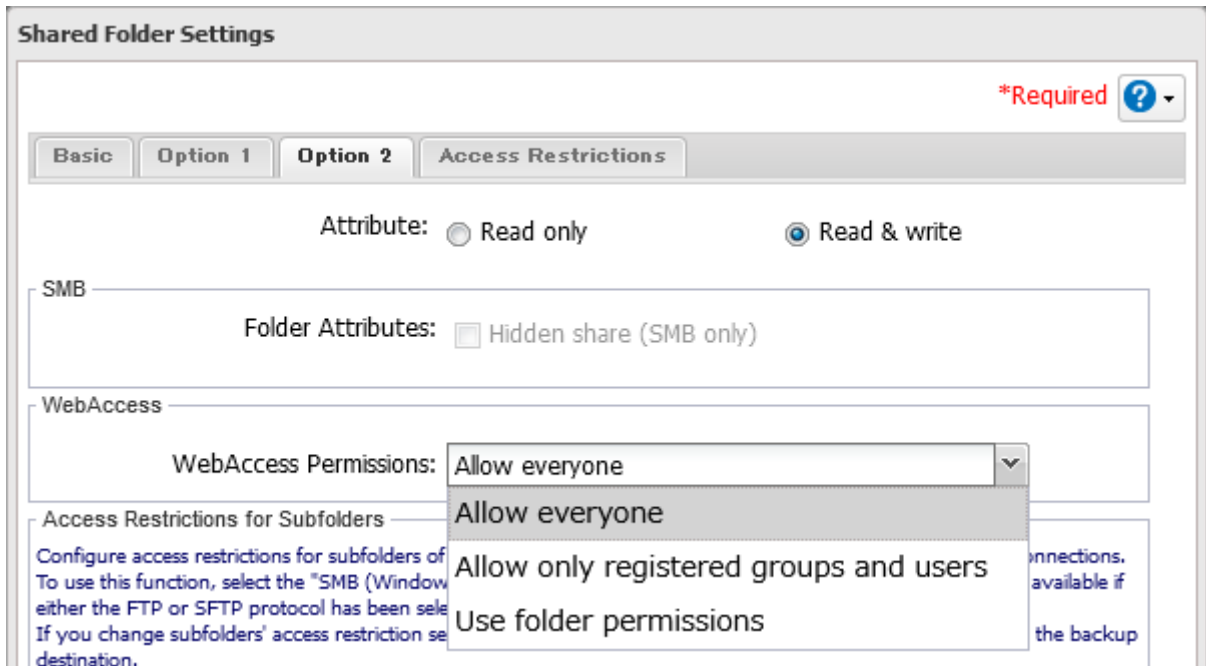

- 11** Configure other settings such as a folder name and click *OK*.

- 12** The process is complete once you close the confirmation window that appears.

**Note:** Whether a user or group can access a folder through WebAccess depends on a combination of WebAccess settings and the shared folder’s settings.

**Allow everyone:** Anyone can access (view) shared folders. (Access restrictions configured for shared folders will not work.)

**Allow only registered groups and users:** All groups and users registered on the Buffalo NAS device can use WebAccess. (Access restrictions configured for shared folders will not work.)

**Use folder permissions:** Users and groups have the same access permissions with WebAccess that they do locally. If access restrictions are not set for the shared folder, then this option will not be shown.

		Not logged in	Access restrictions for the logged-in users		
			No access	Read-only	Read and write
WebAccess permissions	Allow everyone	R	R/W	R/W	R/W
	Allow only registered groups and users	-	R/W	R/W	R/W
	Use folder permissions	-	-	R	R/W

R/W: Read and write, R: Read-only, -: No access

## Accessing via WebAccess

There are many ways to access WebAccess folders depending on your device:

### For iOS or iPadOS Devices

To access from an iOS or iPadOS device, install the “WebAccess i” app for an iOS device or the “WebAccess i HD” app for an iPadOS device from the App Store. Refer to the help guide for the app for more detailed information.

**For Android Devices**

To access from an Android device, install the “WebAccess A” app from Google Play. Refer to the help guide for the app for more detailed information.

**For Computers**

Use a web browser on a computer; supported browsers include Microsoft Edge, Firefox, Google Chrome, Internet Explorer 9 or later, Safari 9 or later. Refer to the help guide at the BuffaloNAS.com website after connecting with your BuffaloNAS.com name for more detailed information.

## Unable to Create a BuffaloNAS.com Name

If UPnP is disabled on your router, creating the BuffaloNAS.com name may fail. If this occurs, try the following procedure.

- 1 From Settings, click *File Sharing*.

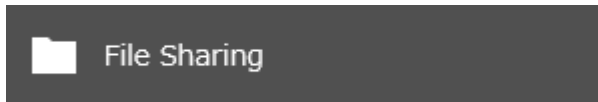

- 2 Click the settings icon (  ) to the right of “WebAccess”.

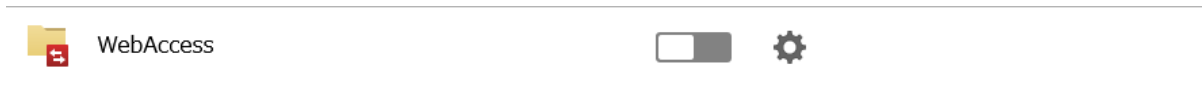

- 3 Click *Edit*.



- 4 Enable “Access via BuffaloNAS.com Server” and the desired BuffaloNAS.com name and key.

 A screenshot of the "WebAccess Settings" dialog box. At the top right, there is a red asterisk and the word "Required" next to a blue question mark icon. The settings are as follows:
 

- HTTPS/SSL Encryption:  Enable  Disable
- Access via BuffaloNAS.com:  Enable
- Server:
  - BuffaloNAS.com Name \*:
  - BuffaloNAS.com Key \*:
  -
- Disable
- Other DNS Service Hostname \*:
- UPnP:  Enable  Disable
- External Port \*:
- NAS Internal Port \*:
- Exclusive Session:  Enable  Disable
- Session Timeout \*:  minutes  Unlimited

 At the bottom, there are three buttons: "LAN Only", "OK", and "Cancel".

- 5 Disable “UPnP” and enter a router’s port number into the “External Port” field, then click *OK*.

**6** Move the WebAccess switch (  ) to the  position to enable WebAccess.



**7** After configuring the required settings on the Buffalo NAS device is finished, next configure the router using the port number set at step 5 above.

---

## FTP

---

By default, the TeraStation's shares are only accessible by users connected to the same network or router as the TeraStation. The optional FTP server allows users outside the local network to access the TeraStation.

**Note:** FTP is intended for users who already have FTP client software and have experience with it.



### Enabling FTP

---

Follow the procedure below to enable FTP service to allow access via FTP connections.

**1** From Settings, click *File Sharing*.



**2** Move the FTP switch (  ) to the  position to enable FTP.



**3** Click the settings icon (  ) to the right of "Folder Setup".



#### 4 Choose a folder to enable remote FTP access on.

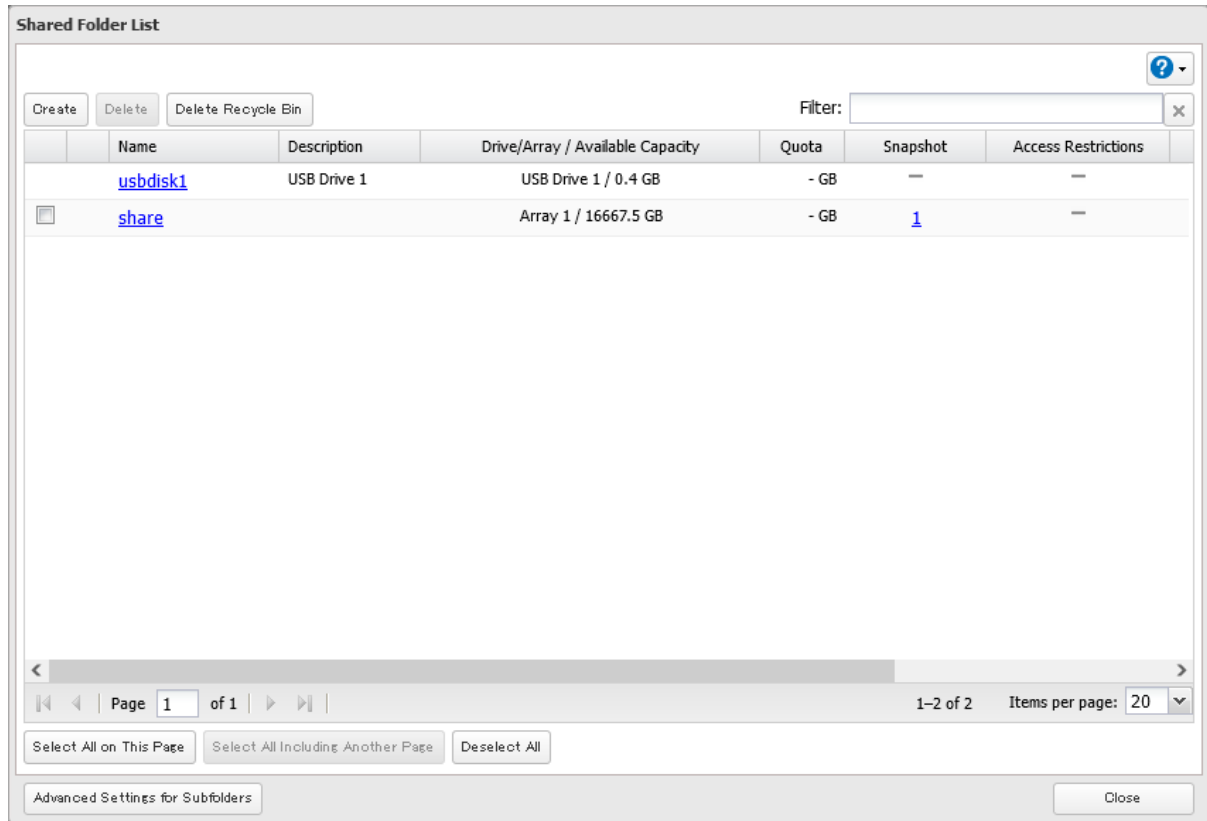

#### 5 Under "LAN Protocol Support", select the "FTP" checkbox on the *Basic* tab; select read-only or read and write for the shared folder's attribute on the *Option 2* tab and click *OK*.

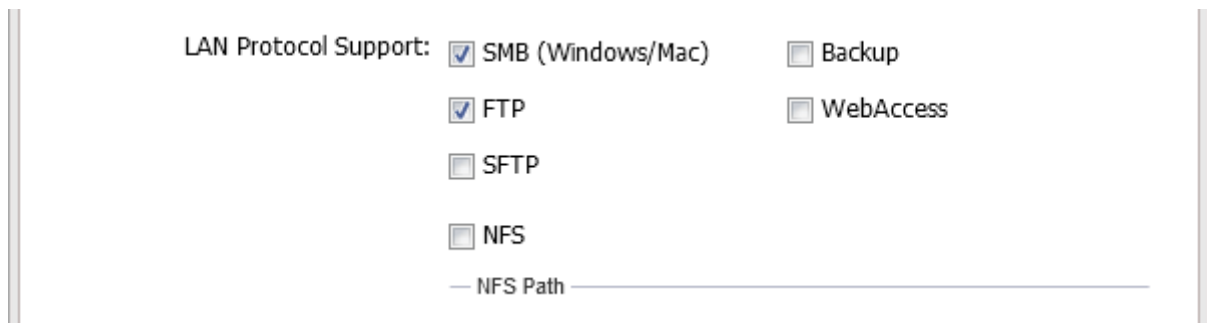

#### 6 The process is complete once you close the confirmation window that appears.

## Accessing the TeraStation with an FTP Client

### Accessing as an Registered User

To access the TeraStation via FTP, configure your FTP client software with the following settings:

- Hostname: IP address of the TeraStation
- Username: the TeraStation's username
- Password: the TeraStation's password
- Port: 21

### Accessing as an Anonymous User

To allow anonymous access to your FTP share, disable access restrictions. Configure your FTP client software with the following settings for anonymous FTP access:

- Hostname: IP address of the TeraStation
- Username: "Anonymous"
- Password: any character string
- Port: 21

**Notes:**

- If the TeraStation joins a domain, domain and anonymous users cannot remote access via FTP. Domain users will be able to access remotely using SFTP.
- Shared folders connected by FTP are available from the "/mnt" folder. The examples of default locations are:
  - /mnt/array1/share
  - /mnt/disk1/share
  - /mnt/usbdisk1
- For FTP connections, make sure that the total filename length including the folder path is 250 single-byte characters or fewer.

# Chapter 7 Security Enhancement

---

## Two-Factor Authentication

---

Two-factor authentication is a security feature that strengthens login security by requiring a verification code in addition to username and password to log in to Settings. Two-factor authentication can better protect both your login credentials and data on the TeraStation.

### Enabling Two-Factor Authentication

---

**Notes:**

- To enable two-factor authentication, enable email notification first. Refer to the [“Email Notification”](#) section in chapter 10 for the detailed procedure.
- Two-factor authentication requires an authenticator app to be installed onto your mobile device. The following authenticator apps are supported:
  - Google Authenticator
  - Microsoft Authenticator
  - Duo Mobile
  - Twilio Authy

**1** From Settings, click *File Sharing*.



**2** Click the settings icon (  ) to the right of “Users”.



**3** Select the logged-in user for whom two-factor authentication will be enabled.

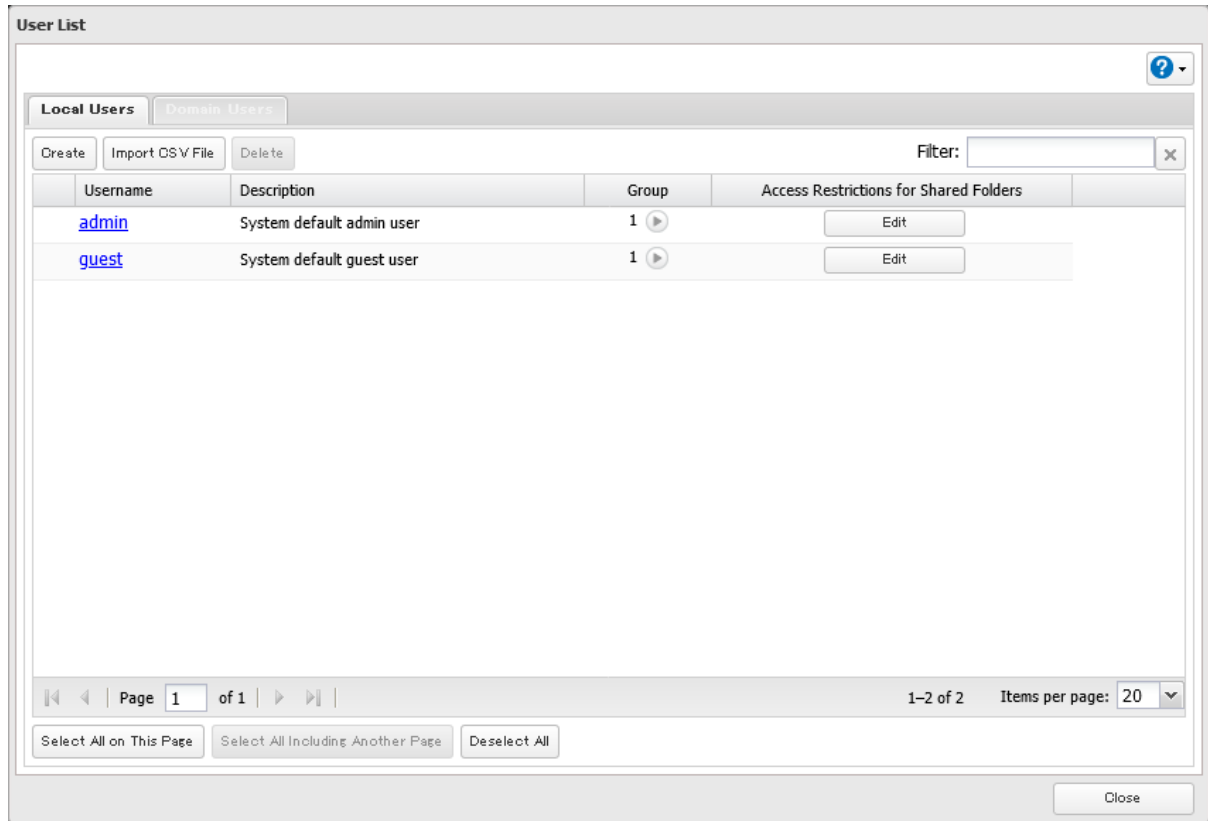

**4** Click *Two-Factor Authentication*.

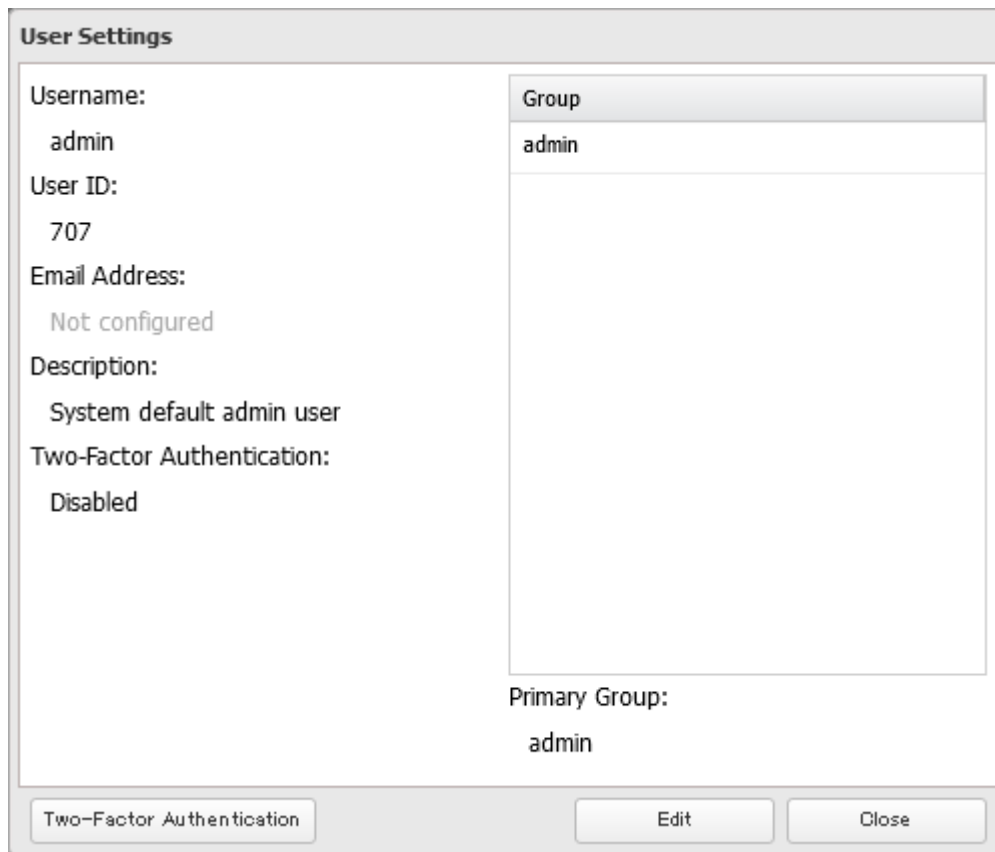

**5** Click *Next*.

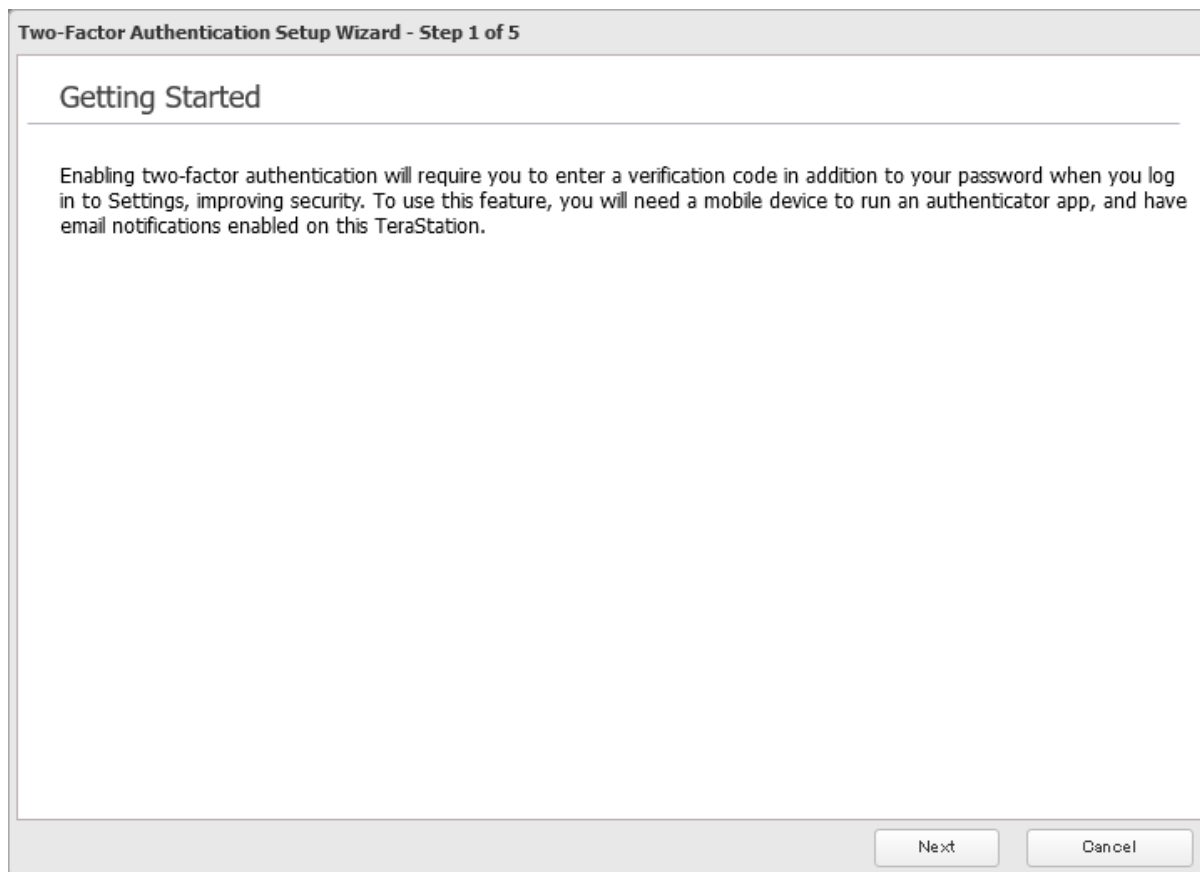

- 6 Enter an email address as an alternative method to receive the verification code and click *Next*.  
Click *Send Test Email* to have a test email sent to the entered address to confirm that the address is correct.

Two-Factor Authentication Setup Wizard - Step 2 of 5

### Configure Email Address for Verification Code

Set the email address to which the verification code will be sent if authentication fails through the app. After entering the email address, click 'Send Test Email' to confirm that the entered email address is correct.

Email Address

**Note:** The entered email address will be assigned to a user. If another email address had already been assigned to the user, it will be changed to the entered email address instead. The email address can be changed from the user settings page.

- 7 Open the installed authenticator app on your mobile device.

- 8 Use the authenticator app to scan the QR code displayed in Settings. Alternatively, enter the setup key into the app. Click *Next* after the app establishes the connection with the TeraStation.

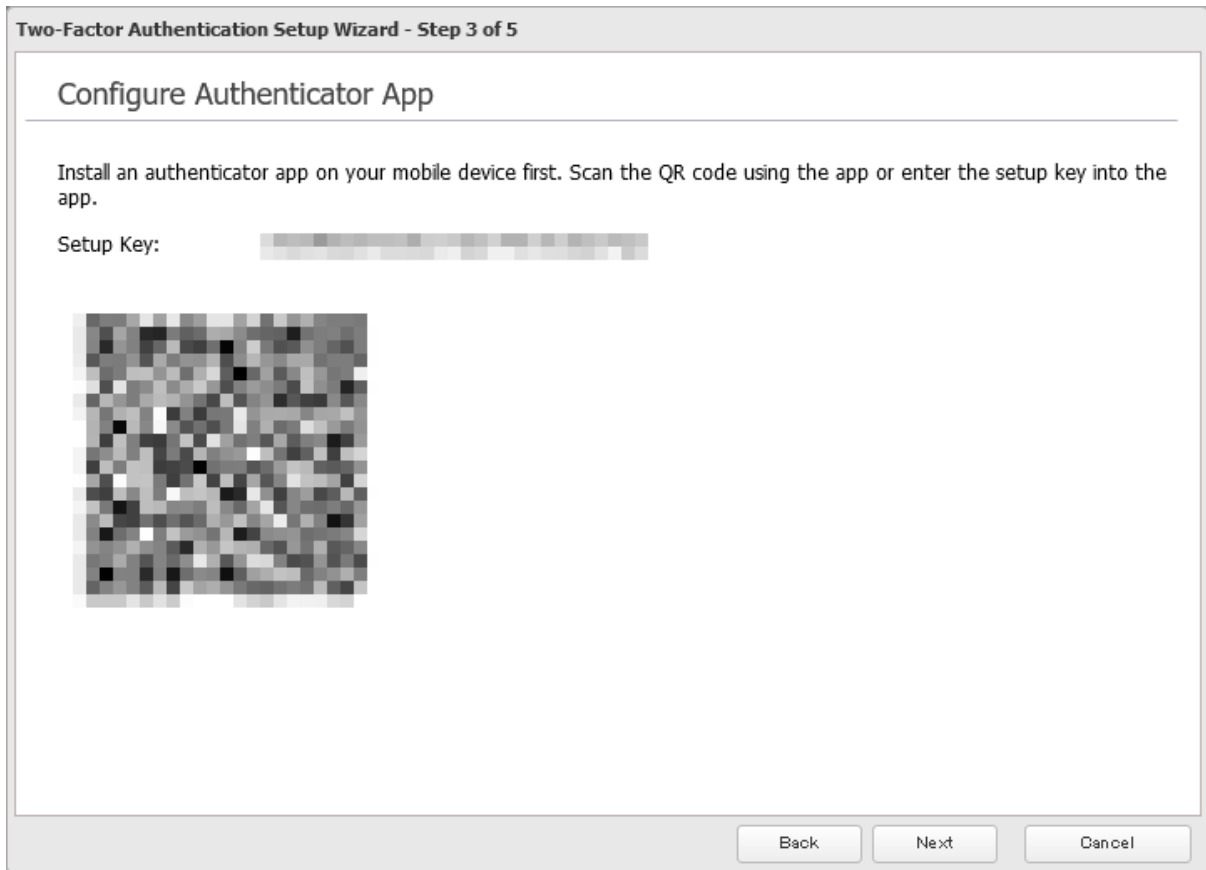

- 9** Enter the 6-digit verification code displayed on the authenticator app and click *Next*.

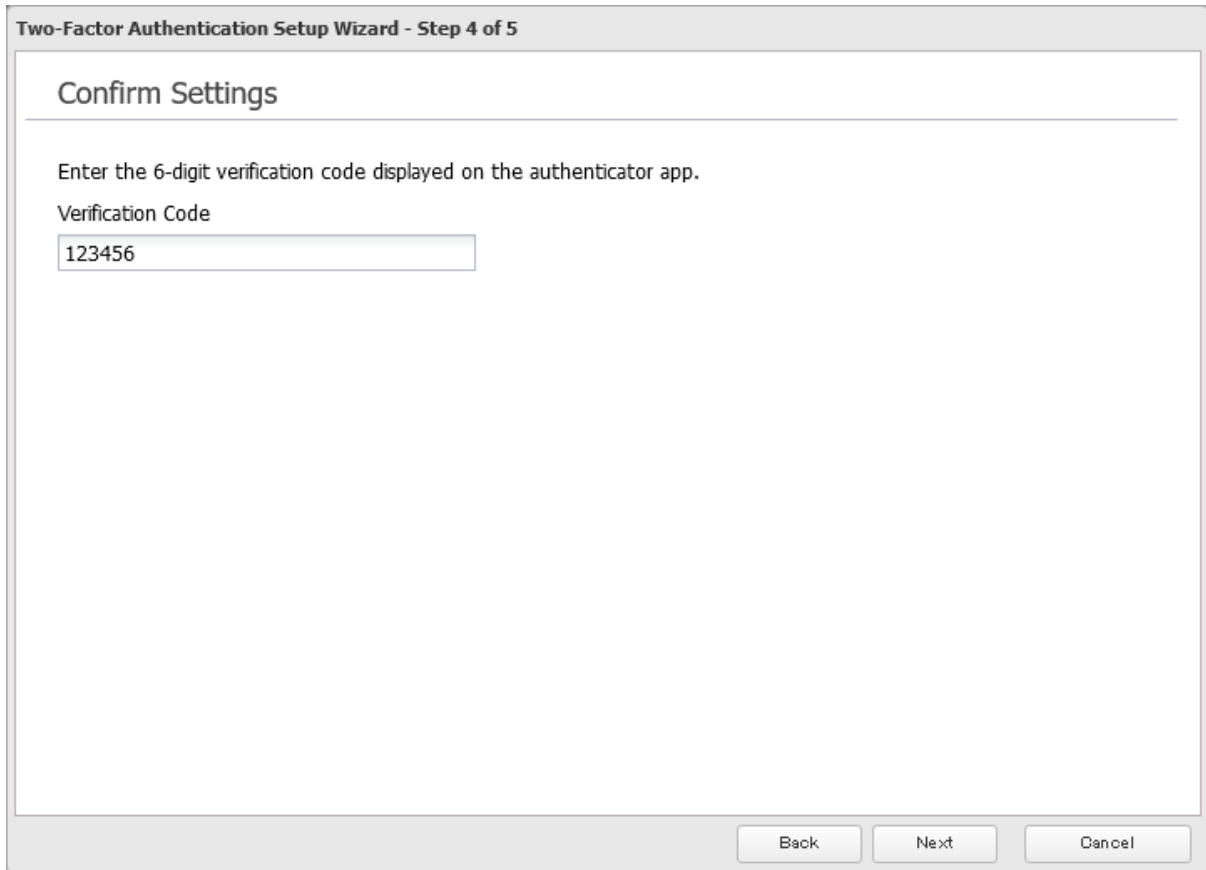

- 10** The process is complete once you close the wizard window that appears.

Two-factor authentication will become active after logging out from Settings. A verification code will be required the next time you log in to Settings using the same username.

**Note:** If authentication fails even if the verification code is valid, make sure the time settings on both the TeraStation and the mobile device are the same.

## Restricting Logins for Non-Admin Users

You can restrict users who do not have administrator privileges from being able to log in Settings.

- 1** From Settings, click *File Sharing*.



- 2** Click the settings icon (  ) to the right of "Users".



**3** Select a user from the user list.

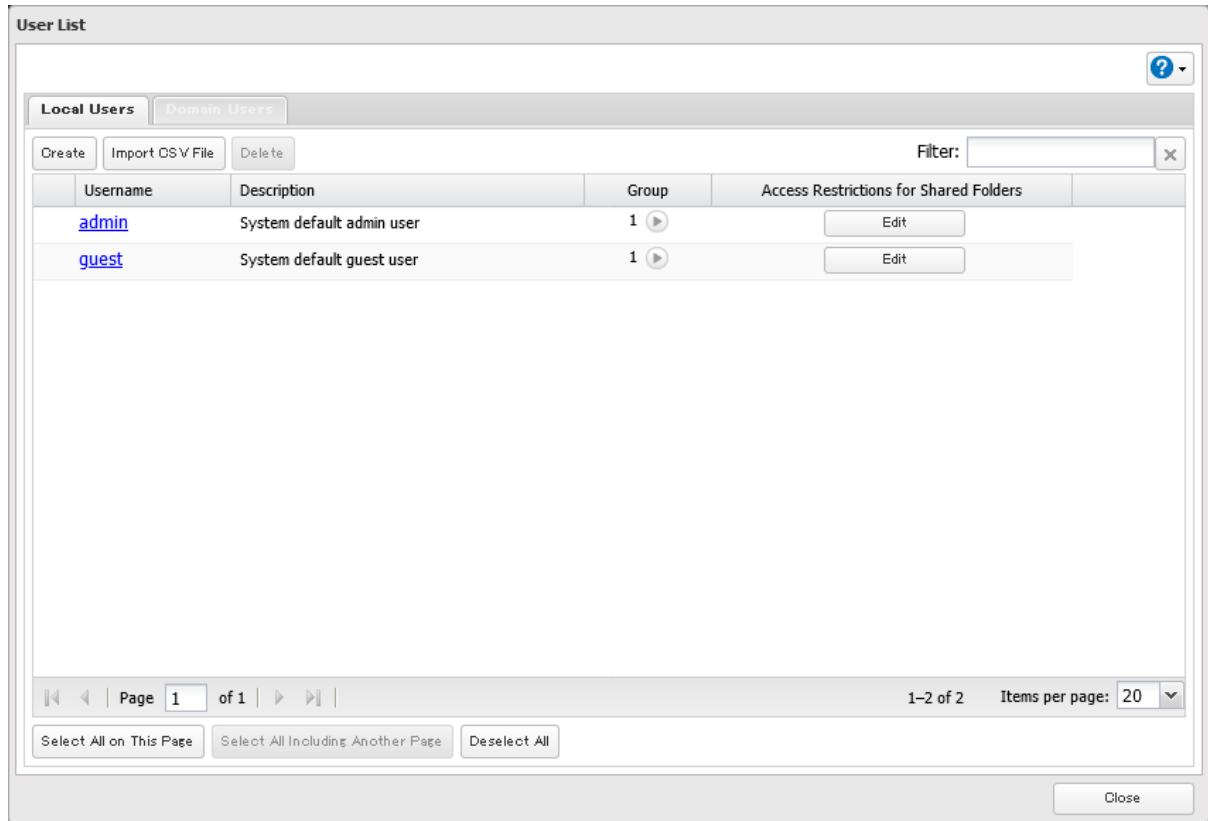

**4** Click *Two-Factor Authentication*.

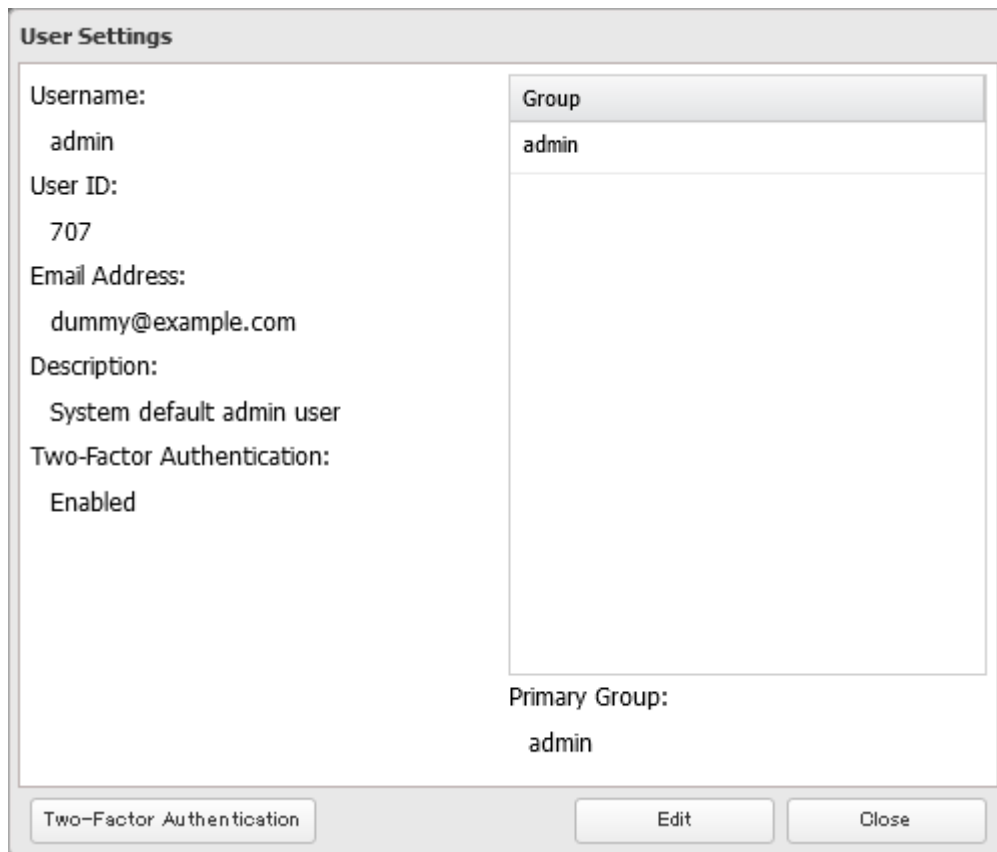

**5** Change the “Settings Interface Access” option to “Deny login by non-administrator users”, then click *OK*.

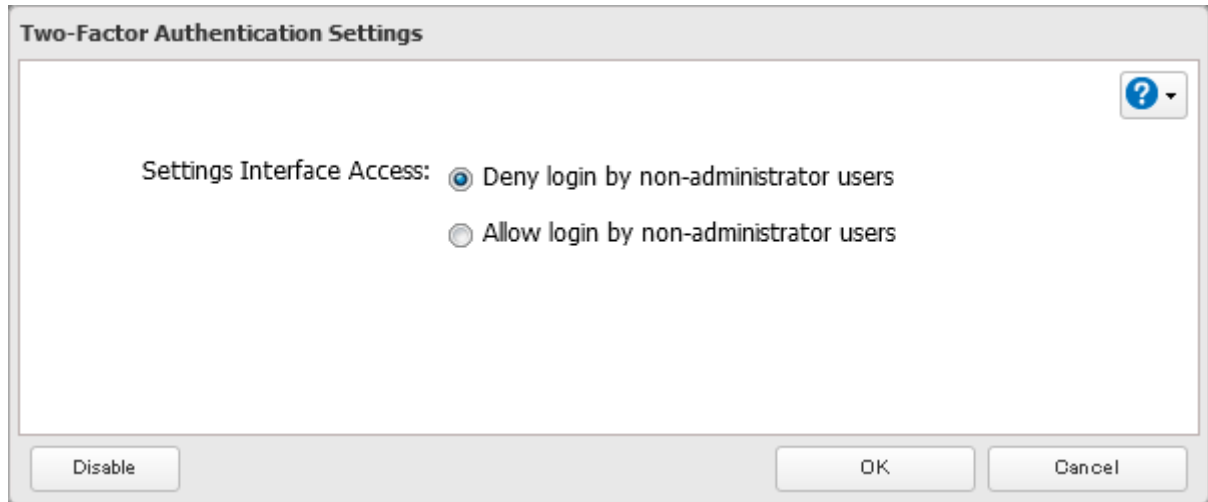

**6** The process is complete once you close the confirmation window that appears.

## Disabling Two-Factor Authentication

---

**1** From Settings, click *File Sharing*.



**2** Click the settings icon (  ) to the right of “Users”.



**3** Select the logged-in user for whom two-factor authentication will be disabled.

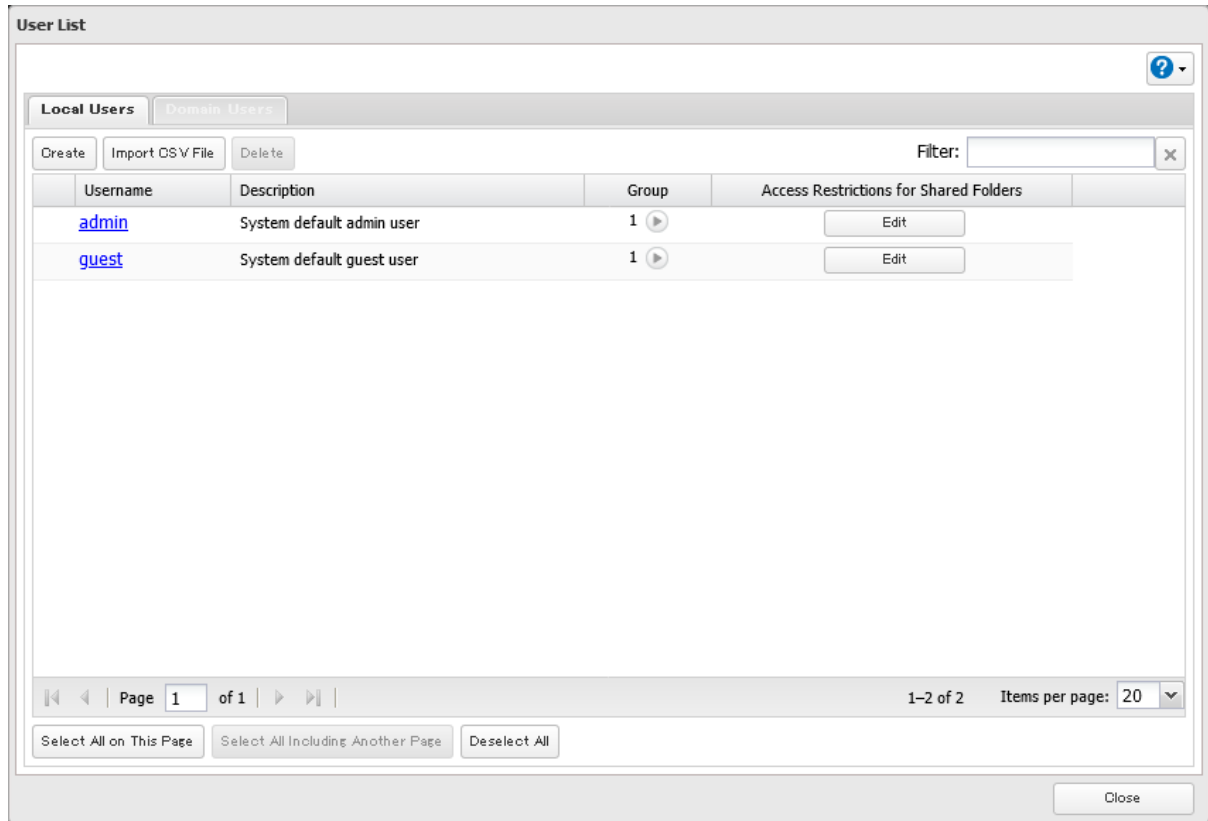

**4** Click *Two-Factor Authentication*.

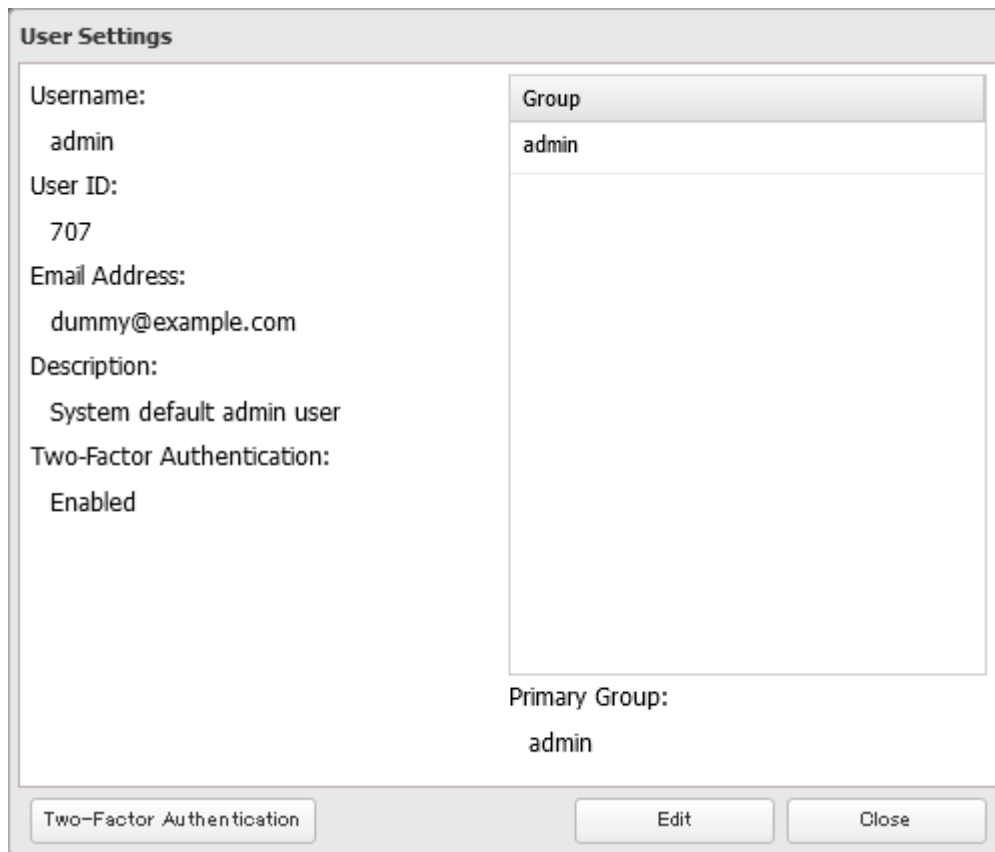

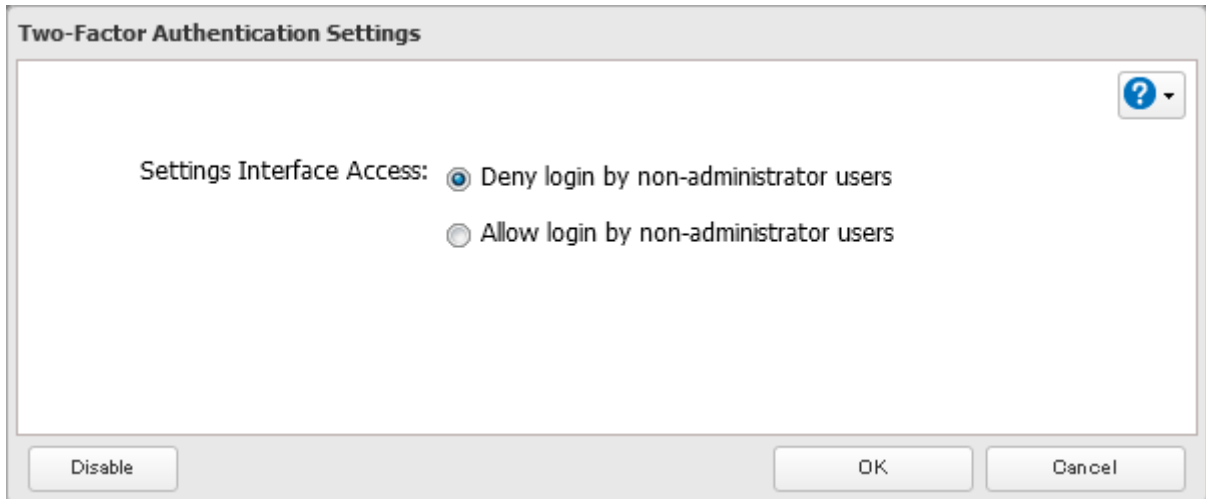
**5** Click *Disable*.**6** The process is complete once you close the confirmation window that appears.

---

## Encrypting Data Transmission

---

### Encrypting Settings Data

---

All communication with Settings can use SSL encryption if you access the Settings page by changing "http://" to "https://" in the browser address bar or click *Secure Connection* from the login window. Once you are logged in using the HTTPS connection and wish to disable SSL encryption, click *Normal Connection* from the login window.

## Encrypting FTP Transfer Data

---

You can encrypt passwords using SSH for secure FTP communication. First, open a shared folder's settings; under "LAN Protocol Support", select the "SFTP" checkbox on the *Basic* tab and click *OK*. Also, you have to enable the SFTP service by moving the SFTP switch to the **on** position on "File Sharing".

**Note:** If SFTP is enabled, guest users and anonymous users will not be able to access shared folders.

## SSL

---

SSL (Secure Socket Layer) is a protocol that uses a public key encryption system to establish secure communication channels between networked devices, allowing for encrypted Internet traffic and server identity verification. The SSL protocol uses a pair of keys – one private, one public – to authenticate and manage secure connections. SSL keys are used during setup screen operations and FTP communication.

### SSL Key Formats/Extensions

The SSL keys may include the following encoding formats and extensions:

#### SSL Certificate (server.crt)

The server.crt is the server public key, and is generated by the TeraStation. A computer that receives the server.crt uses it to encrypt data, and the TeraStation then uses the server.key file to decrypt the data.

In SSL, this key contains the server certificate, and depending on your computer environment, a check may be performed to determine the trustworthiness of the certificate. The server certificate included in the TeraStation's default settings was created by Buffalo, and in some cases, the security certificate warning message may appear in your browser or another security software. If this occurs, disregard the message and continue.

**Note:** Use TLS 1.2 SSL Certificate.

#### SSL Private Key (server.key)

This file is the server private key, and it is usually not revealed. The server.key file is paired with the server.crt file to decrypt data encrypted by the SSL certificate.

**Note:** The passphrase for the private key must be removed before importing to the TeraStation.

### Updating SSL Key Files

To update a server certificate and a private key for SSL, follow this procedure.

- 1 From Settings, click *Management*.

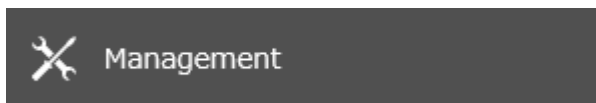

- 2 Click the settings icon (  ) to the right of "SSL".



**3** Register “server.key” for “Secret Key” and “server.crt” for “Server Certificate (.crt)”, then click *Import*.

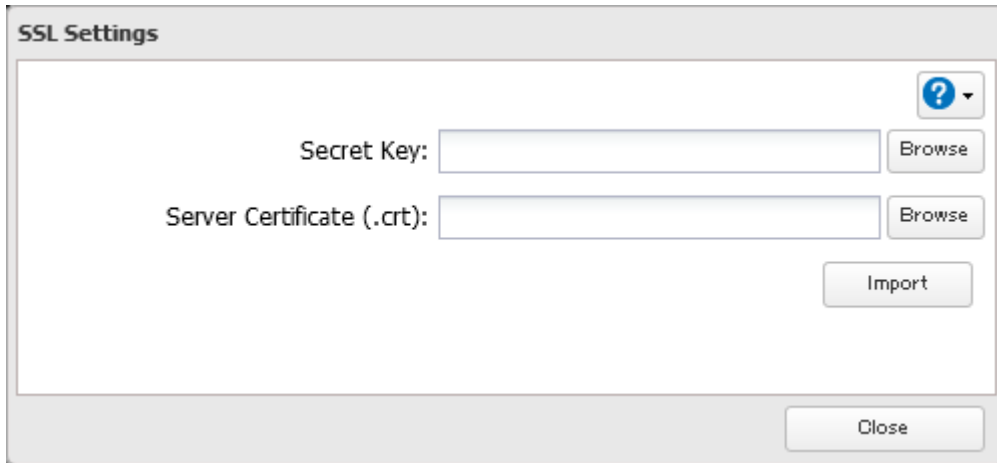

**4** The process is complete once you close the confirmation window that appears.

**Notes:**

- Place the SSL key files (server.key, server.crt) directly below the C root drive. The SSL key files may be unable to be updated if they are placed in folders or paths that contain multibyte characters.
- If Settings cannot be displayed after updating, initialize the TeraStation settings.
- Updating the firmware initializes an SSL key.

# Chapter 8 Settings Backup/Restoration

## Saving and Applying Settings

The TeraStation's settings can be saved to a USB drive and applied to another Buffalo NAS device of the same series. Use this feature to back up or copy settings to a new Buffalo NAS device.

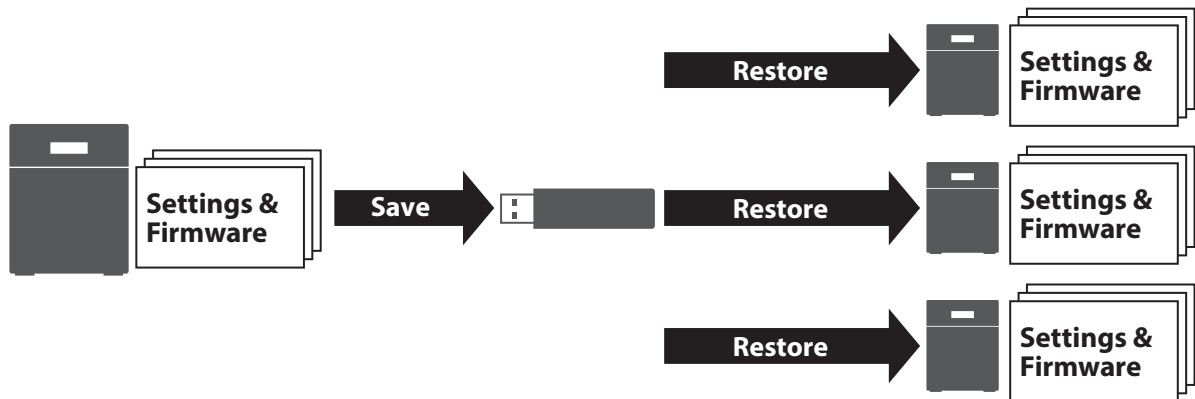

Write down the drive configuration (number of drives, RAID, LVM, etc.) of the Buffalo NAS device whose settings were saved. Make sure that any Buffalo NAS devices that you apply these settings to have the exact same drive configuration before you apply the settings. If the drive configuration is different, you may get unexpected results. The following settings are not saved or applied:

Category	Settings
File Sharing	Subfolders' access restriction settings in the shared folders
	All settings for USB drives
	Two-factor authentication settings in "Users"
	Snapshot settings in "Folder Setup"
Storage	All settings in "Drives"
	All settings in "LVM"
	All settings in "iSCSI"
	USB drive information
Cloud Storage	Job settings of Dropbox Sync
	Job settings of Microsoft OneDrive Sync
Network	All settings except for service port restrictions, Wake-on-LAN, MTU size settings, the "Services Restarted After" option, and FQDN mapping in "IP Address"
	All settings in "Port Trunking"
Backup	All settings except for the <i>Periodic Sync</i> and <i>Advanced Settings</i> tab settings in "Failover"
Management	The TeraStation's hostname
	All settings in "Power Management"
	All settings in "SSL"
	Display language in Settings

## Saving Settings

---

**1** Insert a 1 GB or larger USB drive (not included) into a USB port on the TeraStation.

**Note:** All data on the USB drive will be erased!

**2** From Settings, click *Management*.

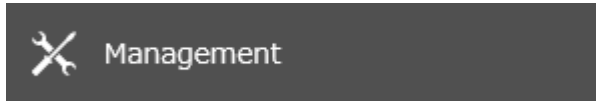

**3** Click the settings icon (  ) to the right of "Configuration Management".



**4** Select "Save current configuration to a USB drive".

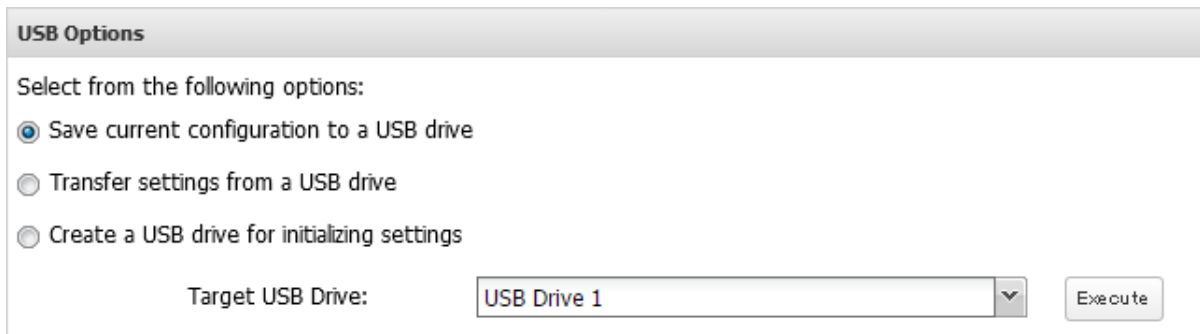

**5** From "Target USB Drive", select the USB drive that is connected to the USB port on the TeraStation, then click *Execute*.

**6** The "Confirm Operation" screen will open. Enter the confirmation number, then click *OK*.

**7** The process is complete once you close the confirmation window that appears.

### Troubleshooting:

If the settings are not saved to the USB drive successfully, you may receive an error message such as "The specified operation cannot be executed.". Verify:

- The USB drive has a capacity of 1 GB or more.
- The USB drive is not write-protected.
- Failover is configured on the TeraStation.

## Applying Settings

---

The saved settings can be applied to a different Buffalo NAS device of the same series. If applying settings to another Buffalo NAS device, the unit's current firmware version will be changed to the version used to save the settings.

**1** Insert the USB drive with the saved settings into a USB port on the TeraStation.

**2** From Settings, click *Management*.

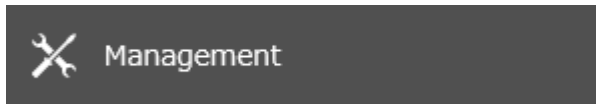

**3** Click the settings icon (  ) to the right of "Configuration Management".

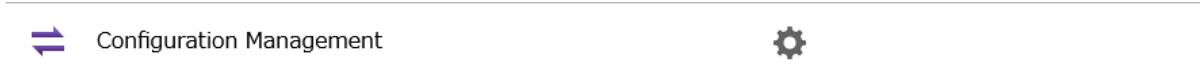

**4** Select "Transfer settings from a USB drive".

**USB Options**

Select from the following options:

Save current configuration to a USB drive

Transfer settings from a USB drive

Create a USB drive for initializing settings

Target USB Drive: USB Drive 1 Execute

**5** From "Target USB Drive", select the USB drive that is connected to the USB port on the TeraStation, then click *Execute*.

**6** The "Confirm Operation" screen will open. Enter the confirmation number, then click *OK*.

**7** The process is complete once you close the confirmation window that appears.

---

## Transferring Another Buffalo NAS Device's Settings

---

You can transfer saved settings from another series Buffalo NAS device to your TeraStation. The following settings can be transferred:

- Shared folders which are created from "File Sharing" > "Folder Setup"
- Access restrictions
- Users\*
- Groups

\*Except two-factor authentication settings

**Note:** This feature currently supports the following Buffalo NAS devices as of November 2022. The latest compatibility information will be on the [Buffalo website](#).

- TS-X series (TS-XL/R5, TS-WXL/R1, TS-WXL/1D, TS-RXL/R5, TS-XEL/R5 TeraStation models) running firmware version 1.58 or later
- TS5000 series (TS5200D, TS5200DN, TS5400D, TS5400DN, TS5400R, TS5400RN, TS5600D, TS5600DN, TS5800D, TS5800DN TeraStation models)
- TS4000 series (TS4200D, TS4400D, TS4400R, TS4800D TeraStation models)
- TS3000 series (TS3200D, TS3400D, TS3400R TeraStation models)
- TS5010 series (TS5210DN, TS5410DN, TS5410RN, TS5810DN, TS51210RH TeraStation models)
- TS3010 series (TS3210DN, TS3410DN, TS3410RN TeraStation models)

- TS6000 series (TS6200DN, TS6400DN, TS6400RN TeraStation models)
- TS3020 series (TS3220DN, TS3420DN, TS3420RN TeraStation models)
- TS5020 series (TS5420DN, TS5420RN, TS5820DN, TS51220RH TeraStation models)

## Creating a Config File (.nas config)

---

### Procedure for TS-X Series Models

To transfer settings from TS-X series TeraStations, it will use the “NS-SHFT” software to create a config file. NS-SHFT can be downloaded from the [Buffalo website](#).

For the procedure on creating the config file, refer to the NS-SHFT user guide.

### Procedure for Buffalo NAS Devices Other Than TS-X Series Models

Follow the procedure below to create a config file on a Buffalo NAS device that is not part of TS-X series TeraStations.

- 1 Refer to the user manual of the Buffalo NAS device whose settings will be saved to a USB drive.
- 2 Access the “usbdisk x” shared folder while connecting the USB drive to the Buffalo NAS device whose settings were saved in the previous step. The “x” in the folder name represents the USB port number you connected the drive to.
- 3 Copy and paste the .nas\_config file to the desired location on your computer.
- 4 The process is complete once the .nas\_config file is saved to the desired location.

## Transferring Settings

---

Follow the procedure below to transfer settings from another series Buffalo NAS device.

- 1 Before transferring access restrictions with Active Directory domain users, make sure the migration target Buffalo NAS devices are joined to the same domain controller. To have the unit join the domain network, refer to the procedure in the [“Restricting AD Domain User Access to Shared Folders”](#) section in chapter 3. If you didn’t configure access restrictions with Active Directory domain users, skip to the next step.
- 2 From Settings, click *Management*.



- 3 Click the settings icon (  ) to the right of “Configuration Management”.



- Click *Browse* and choose the config file (.nas\_config) that was created with the migration source Buffalo NAS device. If the config file was created with a password, enter it into the “Password” field.

**Configuration Migration**

Migrate another TeraStation's users, groups, shared folders, and access restriction settings. Select the config file (.nas\_config) that was saved on the other TeraStation.  
 Note: If the migration source TeraStation is configured with Active Directory, this TeraStation should also have the same configuration, or else migration will not work.

Config File (.nas\_config):

Password:   
(if needed)

- Click *Import*.
- The “Confirm Operation” screen will open. Enter the confirmation number, then click *OK*.
- The process is complete once you close the confirmation window that appears.

**Notes:**

- If the migration target Buffalo NAS device contains shared folders, users, and groups that share the same name as the transferred settings, the existing settings will be overwritten. If the users and groups meet the following conditions, the settings will not be transferred: users share the same name with groups that already exist on the migration target Buffalo NAS device; groups share the same name with users on the migration target Buffalo NAS device.
- If the migration target Buffalo NAS devices have already added some shared folders, users, and groups, the transferred settings may exceed the maximum number of allowed shared folders, users, or groups. Excess items will not be transferred. After migration finishes, open Settings and verify that all settings were properly transferred.

---

## Restoring Factory Defaults

---

The settings on the TeraStation can be restored to factory defaults using Settings or an USB drive.

### Initializing from Settings

---

To initialize the TeraStation to its factory defaults from Settings, follow the procedure below.

- From Settings, click *Management*.

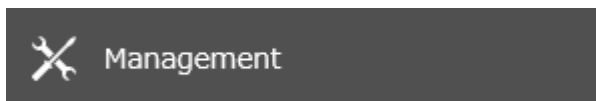

- Click the settings icon (  ) to the right of “Restore/Eraser”.

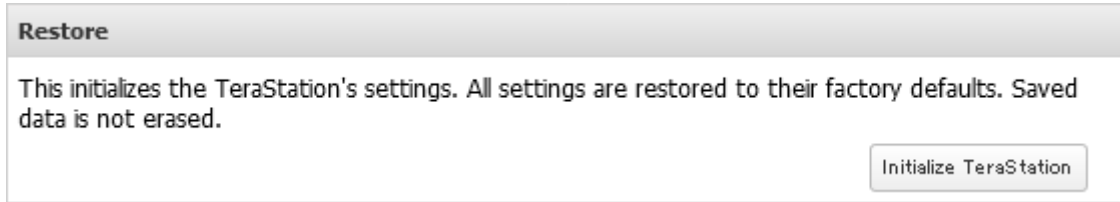

**3** Click *Initialize TeraStation*.**4** The “Confirm Operation” screen will open. Enter the confirmation number, then click *OK*.**5** The settings will be restored to its factory default settings. The I26 message will appear as a notification while settings are being restored.**6** The process is complete when the I26 message disappears.

## Initializing Using the USB Initialization Drive

---

A USB initialization drive will restore the settings on your TeraStation to their factory defaults. You can initialize them without logging in to Settings. Follow the procedure below to create a USB initialization drive.



**Notes:**

- You can use the USB initialization drive to initialize settings on the same TeraStation unit that created it.
- Normally, making and using a USB initialization drive will not affect data on the TeraStation. However, always back up your data regularly!
- This USB initialization drive can be used to recover the system if your TeraStation doesn't boot at all. In this case, if the data partition is damaged, then all your data will be deleted by the recovery process.

### Creating a USB Initialization Drive

**1** Insert a 1 GB or larger USB drive (not included) into a USB port on the TeraStation.

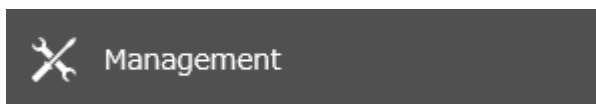
**Note:** All data on the USB drive will be erased!

**2** From Settings, click *Management*.**3** Click the settings icon (  ) to the right of “Configuration Management”.

**4** Select “Create a USB drive for initializing settings”.

**USB Options**

Select from the following options:

Save current configuration to a USB drive

Transfer settings from a USB drive

Create a USB drive for initializing settings

Target USB Drive:

**5** From “Target USB Drive”, select the USB drive that is connected to the USB port on the TeraStation, then click *Execute*.**6** The “Confirm Operation” screen will open. Enter the confirmation number, then click *OK*.**7** The process is complete once you close the confirmation window that appears. Refresh the browser and log in to Settings again.**Starting Initialization**

To initialize the settings on your TeraStation with the USB drive created above, follow the procedure below.

**Note:** If using the USB initialization drive to initialize, the unit’s current firmware version will be changed to the version used to create the USB initialization drive.

- 1** Turn off the TeraStation by pressing and holding down the power button for three seconds.
- 2** Insert the USB drive into a USB port on the TeraStation. Make sure that no other USB drives are currently connected to any USB ports on the TeraStation.
- 3** Power on the TeraStation while holding down the function button.
- 4** When the **I41** message appears as a notification, press the function button.
- 5** The **I37** message will appear as a notification and the **Invalid Firmware** message will appear on the LCD panel while the initialization process is running. It will take several minutes to initialize the settings. The TeraStation will restart when it’s finished.
- 6** The process is complete when the **I37** message disappears.

Dismount the USB drive before unplugging it. Refer to the [“Dismounting Drives”](#) section in chapter 4 for the procedure on dismounting drives.

---

**Resetting the Administrator Password**

---

If you forget the admin username or password and cannot log in to Settings, or incorrect network settings are configured and Settings becomes inaccessible, initialize these settings by following the procedure below.

- 1** Press and hold down the reset button (refer to the [“Diagrams”](#) section in chapter 2) for 10 seconds.
- 2** The TeraStation will beep and the **I23** message will appear as a notification during initialization.

**3** The process is complete when the **I23** message disappears.

This will typically reset the admin username and password, two-factor authentication settings, IP settings other than Wake-on-LAN, port trunking, SSL, and service port restriction settings to their factory default values.

This button can be disabled in Settings; to do so, navigate to *Management > Restore/Erase > Edit* under “Reset Button Settings”, then select “Keep current admin username and password” and click *OK*.

# Chapter 9 Network Settings

## Wake-on-LAN

The TeraStation supports Wake-on-LAN, which allows it to be turned on remotely. The TeraStation will be turned on automatically in the following situations: receiving a Wake-on-LAN packet, recovering from a power outage, disconnecting and reconnecting the power cable.

**Note:** LAN port 3 (10GbE) cannot be used for Wake-on-LAN.

**1** From Settings, click *Network*.



**2** Click the settings icon (  ) to the right of "IP Address".



**3** Click *Edit*.

**4** Enable "Wake-on-LAN", then click *OK*.

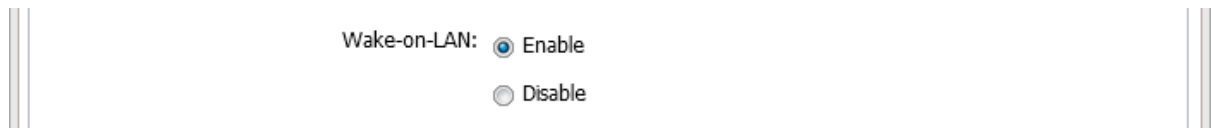

**5** The process is complete once you close the confirmation window that appears.

Wake-on-LAN is now enabled. As long as the TeraStation is connected to a power source and the network, you can turn it on remotely.

### Notes:

- After receiving the Wake-on-LAN packet, the TeraStation may take up to five minutes to be ready to use.
- To use Wake-on-LAN, you'll need Wake-on-LAN software that sends Wake-on-LAN packets. The TeraStation does not include Wake-on-LAN software.
- The TeraStation does not support using Wake-on-LAN and port trunking at the same time. You may use either feature, but not both at the same time.

## Port Trunking

Two Ethernet cables can be used to establish two separate communication routes, providing LAN port redundancy and improving communication reliability. The use of two Ethernet cables enables access to the TeraStation even if one of the cables becomes disconnected.

The port trunking modes that can be set on the TeraStation are shown below:

Trunking Mode	Characteristics
Active-backup	Only one NIC slave in the bond is active. A different slave becomes active if and only if the active slave fails.
Dynamic link aggregation	Creates aggregation groups that share the network speed and duplex settings. Utilizes all slave network interfaces in the active aggregator group according to the 802.3ad specification. <b>Note:</b> To use this mode, a separate intelligent switch that supports IEEE 802.3ad is required. Configure LACP on the switch first.
TLB	The outgoing network packet traffic is distributed according to the current load (relative to the speed) on each network interface slave.
ALB	The incoming and outgoing network packet traffic is distributed according to the current load on each network interface slave. The receive load balancing is achieved by ARP negotiation.

**Note:** If the TeraStation is being used as an iSCSI drive, disable iSCSI before changing network settings such as port trunking. Navigate to *Storage > iSCSI* in Settings and move the iSCSI switch to the **off** position temporarily.

- 1 Connect the hub's LAN port and TeraStation's LAN port using two Ethernet cables. If you are using an intelligent switch, connect the LAN port that was previously configured for port trunking.
- 2 From Settings, click *Network*.



- 3 Click the settings icon (  ) to the right of "Port Trunking".



- 4 Select the LAN port that will be used from the drop-down list.

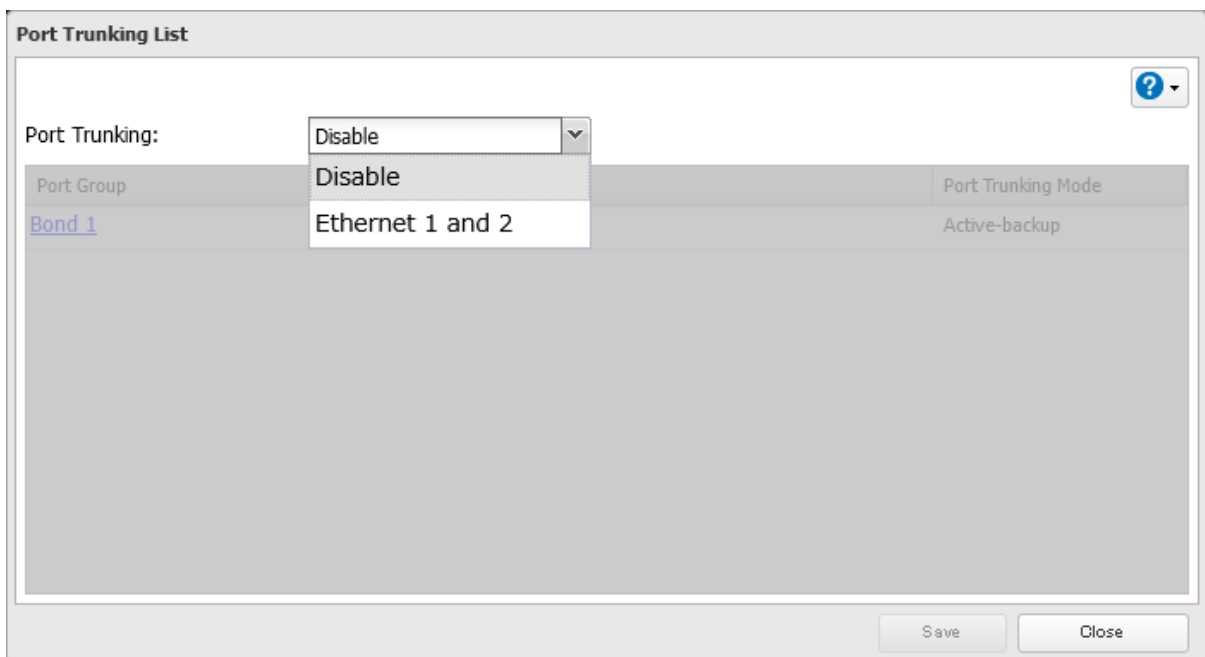

**5** Click a port trunking bond.

**Port Trunking List**

Port Trunking:

Port Group	Status	Port Trunking Mode
<a href="#">Bond 1</a>	Disabled	Active-backup

Save Close

**6** Select the port trunking mode and click *OK*.

**Port Trunking Settings**

Port Trunking:

Device Name ▲	IP Address	Subnet Mask	MTU Size
LAN Port 1	192.168.10.56	255.255.255.0	1500 bytes
LAN Port 2	--	--	1500 bytes

OK Cancel

**7** Click *Save*.

**Port Trunking List**

Port Trunking:

Port Group	Status	Port Trunking Mode
<a href="#">Bond 1</a>	Disabled	Active-backup

Save Close

**8** Read the message carefully and click *Yes*.

**Note**

 Are you sure you want to change your current port trunking configuration?

Yes No

**9** Click *Yes* to restart the TeraStation. If you select “No”, make sure you restart the TeraStation at a later time to apply port trunking settings.

**Note**

 Restarting TeraStation is required to apply changes. Are you sure you will restart the TeraStation after configuring?

Yes No

**10** The process is complete after the TeraStation has been restarted.

---



## SNMP

---

If SNMP is enabled, you can browse your TeraStation from SNMP-compatible network management software. Examples of frequently-notified traps are described in the [“Relevant Trap List”](#) subsection below.

**1** From Settings, click *Network*.



**2** Move the SNMP switch (  ) to the  position to enable SNMP.

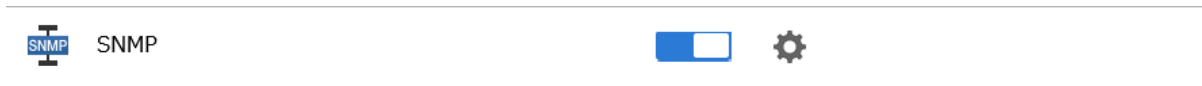

**3** Click the settings icon (  ) to the right of "SNMP".



**4** Click *Edit*.

**5** Select whether to use SNMP version 2 or version 3.

**SNMP Settings** \*Required ?

Use SNMPv2

SNMP Community Name \* :

Trap Notify:  Enable  
 Disable

Trap Settings

Trap Notify Community Name \* :

Trap Notify IP Address \* :

Use SNMPv3

Username \* :

Authentication and Privacy Protocol: SHA / AES

Authentication and Privacy Password \* :

Password (Confirm) \* :

**6** Configure the desired settings, then click *OK*.

**7** The process is complete once you close the confirmation window that appears.

SNMP is now enabled. For further use, configure your SNMP-compatible network management software using the Buffalo-specific MIB (management information base) file. The MIB file is available from the [Buffalo website](#). Depending on which SNMP client software you use, the procedure for configuring the software will differ. For more detailed information on configuring the client software, refer to its help or included manual.

**Note:** The SNMP community name may contain up to 255 alphanumeric characters, hyphens (-), underscores (\_), spaces, commas (,), periods (.), semicolons (;), tildes (~), and the symbols ! # & @ \$ \* % + : = ? ) ( ' / \.

## Relevant Trap List

### Standard Public MIB Traps

Conditions	Trap Name	OID
SNMP service starts.	coldStart	1.3.6.1.6.3.1.1.5.1
SNMP service ends.	nsNotifyShutdown	1.3.6.1.4.1.8072.4.0.2

### Private MIB Traps

If any traps are not listed in the following chart, refer to the web page for downloading the private MIB file on the [Buffalo website](#) for more detailed information.

Conditions	Trap Name
Backup fails.	nasBackupStatus
The RAID array is in degraded mode.	nasDiskStatus
An error occurs and an error code is displayed.	nasErrorOccur
An event occurs and an event code is displayed.	nasInformationOccur

## Proxy Server

If you place the TeraStation on a network that passes through a proxy server, configuring the proxy server settings is recommended. Unless you configure the proxy settings, firmware updates in Settings will not work. To configure the settings, follow the procedure below.

**1** From Settings, click *Network*.



**2** Click the settings icon (  ) to the right of "Proxy Server".

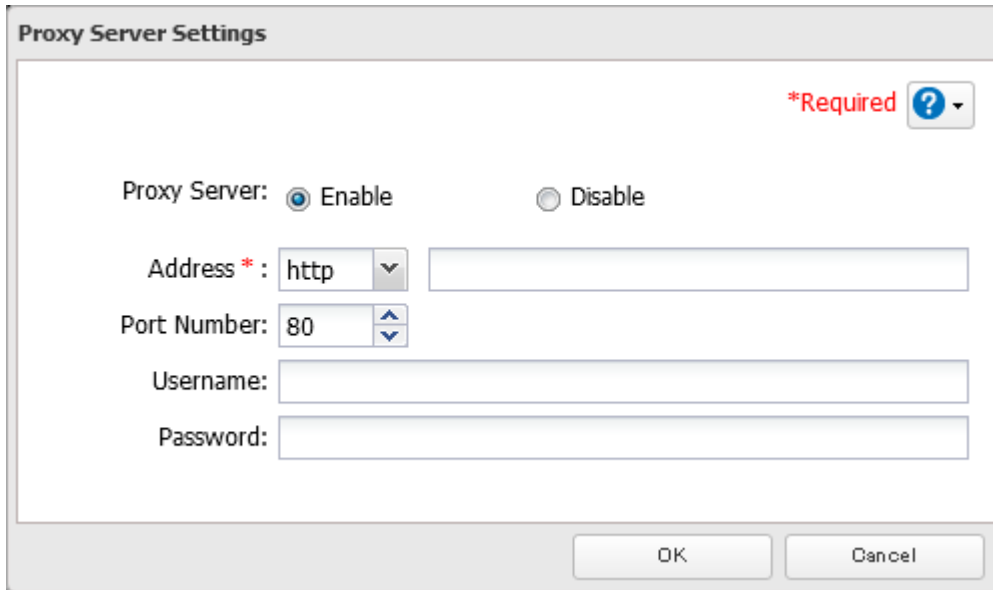

**3** Enable “Proxy Server”.

The image shows a dialog box titled "Proxy Server Settings". In the top right corner, there is a red asterisk followed by the word "\*Required" and a blue question mark icon. Below this, the "Proxy Server" section has two radio buttons: "Enable" (which is selected) and "Disable". Underneath, there are four input fields: "Address \*:" with a dropdown menu set to "http" and an empty text box; "Port Number:" with a spinner box set to "80"; "Username:" with an empty text box; and "Password:" with an empty text box. At the bottom of the dialog, there are "OK" and "Cancel" buttons.

**4** Enter the proxy server IP address or hostname, port number, username and password, then click *OK*.

Once you configure the proxy server settings, you may use the settings for features that will link with cloud storage services by selecting the “Configured settings” option on each settings page.

---

## Jumbo Frames

---

If your other network devices support jumbo frames, you may be able to improve network performance.







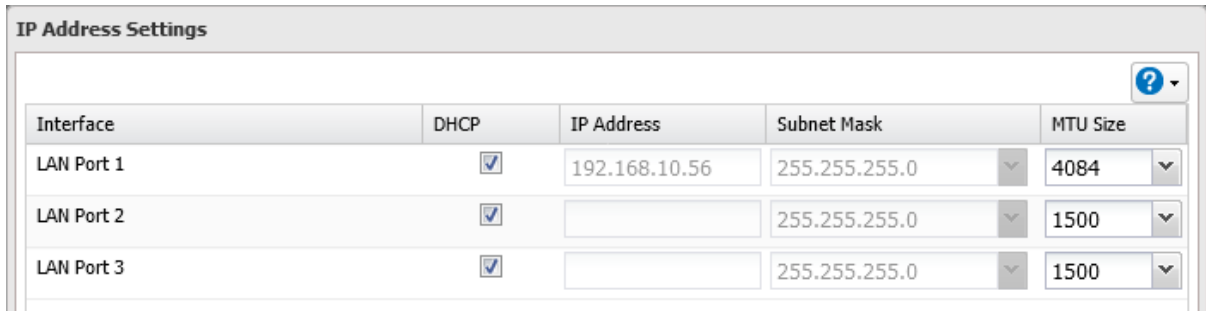









**Note:** If the TeraStation is being used as an iSCSI drive, to change the settings, navigate to *Storage > iSCSI* in Settings and move the iSCSI switch to the **off** position temporarily before changing settings.

**1** From Settings, click *Network*.**2** Click the settings icon (  ) to the right of “IP Address”.**3** Click *Edit*.

**4** Select or enter the desired MTU size and click *OK*.



**5** The process is complete once you close the confirmation window that appears.

Connection			Transmission	
	Jumbo Frame Compatible Switch 	Jumbo Frame Compatible PC 		Transfer data using jumbo frames.
	Jumbo Frame Compatible Switch 	Jumbo Frame <b>Incompatible</b> PC 		Transfer data without using jumbo frames.
	Jumbo Frame <b>Incompatible</b> Switch 	Jumbo Frame <b>Incompatible</b> PC 		Transfer data without using jumbo frames.
	Jumbo Frame <b>Incompatible</b> Switch 	Jumbo Frame Compatible PC 		No data can be transferred.

**Note:** Make sure the TeraStation's MTU size is smaller than the hub or router's. Larger MTU sizes may not transfer the data to the TeraStation correctly.

## Changing the IP Address

Normally, the TeraStation's IP address is set automatically by a DHCP server on your network. If you prefer, you can set it manually. An easy way to do this is to change it on NAS Navigator2. The procedure to change the IP address in Settings is below.

**Note:** If the TeraStation is being used as an iSCSI drive, to change the settings, navigate to *Storage > iSCSI* in Settings and move the iSCSI switch to the **off** position temporarily before changing settings.

**1** From Settings, click *Network*.



**2** Click the settings icon (  ) to the right of "IP Address".



**3** Click *Edit*.

**4** Clear the "DHCP" checkbox and enter the desired IP address and its subnet mask.

 A dialog box titled "IP Address Settings" with a question mark icon in the top right corner. It contains a table with the following data:
 

Interface	DHCP	IP Address	Subnet Mask	MTU Size
LAN Port 1	<input type="checkbox"/>	192.168.10.56	255.255.255.0	1500
LAN Port 2	<input checked="" type="checkbox"/>		255.255.255.0	1500
LAN Port 3	<input checked="" type="checkbox"/>		255.255.255.0	1500

**5** Select "User (static)" from the drop-down list for both the "Gateway Owner" and "DNS Owner" options, then enter the desired default gateway address and DNS server addresses.

 A dialog box showing configuration options for Gateway and DNS. The fields are:
 

- Gateway Owner: User (static) (dropdown menu)
- Default Gateway Address: 192.168.10.1 (text input)
- DNS Owner: User (static) (dropdown menu)
- Primary DNS Server: 192.168.10.1 (text input)
- Secondary DNS Server: (empty text input)
- Services Restarted After: 1 (dropdown menu) seconds

 At the bottom right, there are "OK" and "Cancel" buttons.

**6** Click *OK*. The process is complete once you close the confirmation window that appears.

**Notes:**

- Only one default gateway and DNS address can be configured for all LAN ports. Different network addresses cannot be assigned to the LAN ports.
- Do not set the IP address of the same segment for all LAN ports. This may cause unstable network communication.
- Network services such as SMB or FTP will restart when the Ethernet cable is disconnected/reconnected or if a network issue occurs. You can specify the time to delay the restart at the "Services Restarted After" option.

- When you disable DHCP, all addresses including default gateway and DHCP server addresses cannot be assigned automatically, even if you can select the “Assign automatically” options for them.

## Mapping IP Address and Hostname

The TeraStation allows you to map an IP address and a hostname (FQDN) of another host you would like the TeraStation to communicate with, such as the domain controller. If you configure the mapping pair, the TeraStation can be accessed using the configured pair when name resolution is needed. Follow the procedure below to configure FQDN mapping.

- 1 From Settings, click *Network*.



- 2 Click the settings icon (  ) to the right of “IP Address”.



- 3 Click *FQDN Mapping*.

**IP Address List**

Interface	Type	DHCP	IP Address	Subnet Mask	MTU Size	More D
LAN Port 1	1GbE	✓	192.168.10.56	255.255.255.0	1500 bytes	▶
LAN Port 2	1GbE	✓	—	—	1500 bytes	▶
LAN Port 3	10GbE	✓	—	—	1500 bytes	▶

Wake-on-LAN: Enabled

Gateway Owner: Automatically assigned (LAN Port 1)

Default Gateway Address: 192.168.10.1

DNS Owner: Automatically assigned

Primary DNS Server: 192.168.10.1

Secondary DNS Server: Not assigned

Services Restarted After: 1 seconds

Allowed Protocols for Each Port
Port Trunking
FQDN Mapping
Edit
Close

**4** Click *Add*.

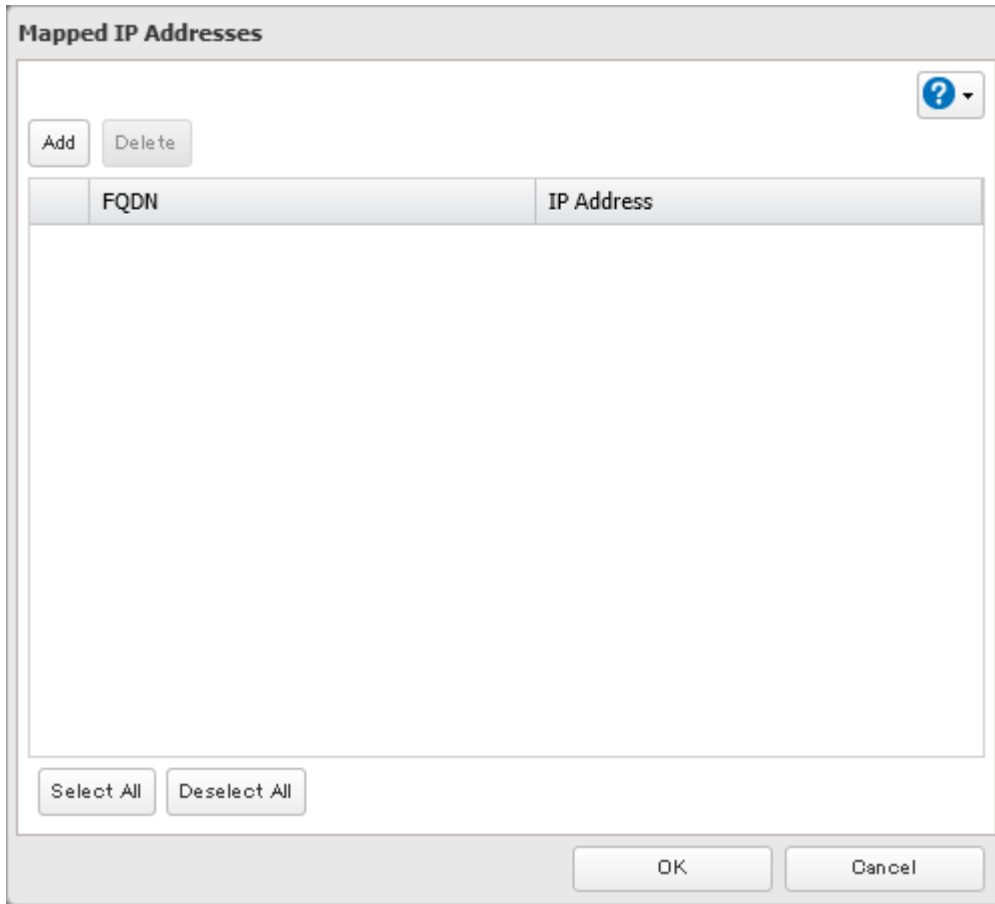

**5** Enter the hostname (FQDN) and the IP address that you want to map, then click *OK*.

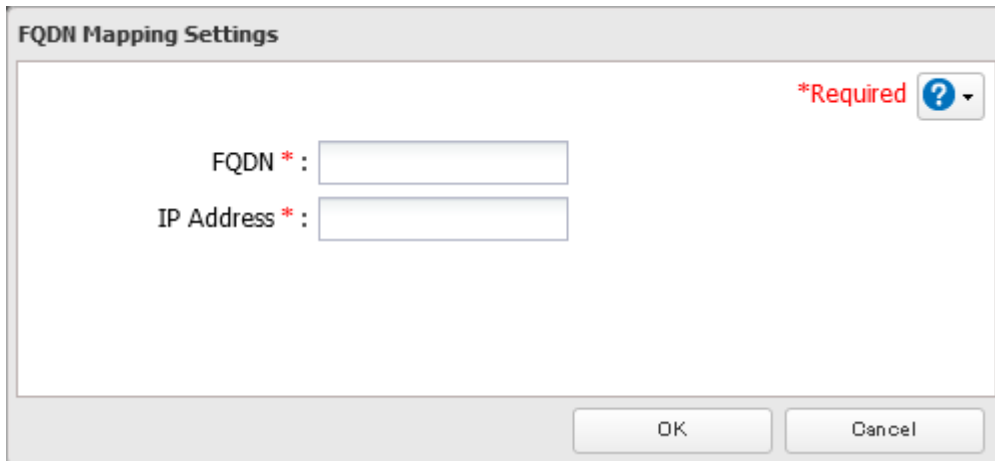

**6** Click *OK* again. The process is complete once you close the confirmation window that appears.

# Chapter 10 Advanced Features

## Email Notification

Your TeraStation can send you email reports daily, or whenever settings are changed or an error occurs. You can configure the events that will trigger notifications from any of the following functions: quotas, drives (internal, external, or RAID array), fan, backup, replication, failover, system alert.



Refer to the contextual help in Settings for more detailed information such as when the notification email will be sent or the differences between the notification categories.

### Enabling Email Notification

Follow the procedure below to enable email notification functionality.

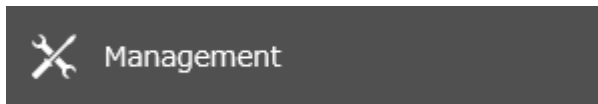
- 1 From Settings, click *Management*.



- 2 Move the email notification switch (  ) to the  position to enable email notification.



- 3 Click the settings icon (  ) to the right of "Email Notification".



- 4 Click *Edit*.

- 5** Enter your email server settings and the notification email's default subject, then configure recipients and the time when email reports will be sent.

If you select an authentication type other than "Disable" from the drop-down list, you can enter the sender email address and credentials of the email server.

**Email Notification Settings**

\*Required ?

SMTP Server Address \* : smtp.ne.jp

SMTP Port \* : 25

Authentication Type: Disable

Sender Address:

POP3 Server Address:

POP3 Port: 110

SSL/TLS: Disable

Username:

Password:

Subject \* : TeraStation Status

Add Delete Select from List

Recipients \* :

Name	Recipients	Class

Select All Deselect All

Send Daily Report at: 00:00

OK Cancel

- 6** Click *OK*. The process is complete when you select either *Yes* or *No* to have a test email sent.

## Changing Events for Email Reports

- 1** From Settings, click *Management*.

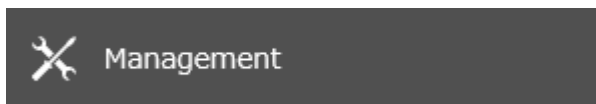

- 2** Click the settings icon (  ) to the right of "Email Notification".

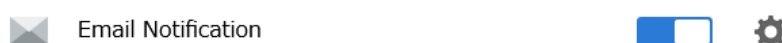

- 3** Click *Advanced Report Settings*.

**4** On the displayed screen, select or clear the category's checkboxes, then click *OK*.

Categories	<input checked="" type="checkbox"/> Daily Report	<input checked="" type="checkbox"/> Info	<input checked="" type="checkbox"/> Notice	<input checked="" type="checkbox"/> Error
Drive Quota			<input checked="" type="checkbox"/>	
Storage	Internal Drive	<input checked="" type="checkbox"/>	<input checked="" type="checkbox"/>	<input checked="" type="checkbox"/>
	RAID Array	<input checked="" type="checkbox"/>	<input checked="" type="checkbox"/>	<input checked="" type="checkbox"/>
	USB Drive	<input checked="" type="checkbox"/>		
Fan				<input checked="" type="checkbox"/>
Backup		<input checked="" type="checkbox"/>	<input checked="" type="checkbox"/>	
Replication			<input checked="" type="checkbox"/>	
Failover		<input checked="" type="checkbox"/>	<input checked="" type="checkbox"/>	
System Alert		<input checked="" type="checkbox"/>		

Notification emails will be categorized into the following importance levels. Refer to the chart below for the detailed information of category importance levels.

Levels	Details
Daily Report	Describes the status of the TeraStation in a daily report email.
Info	Sends a notification email if an event occurs. Info reports will contain just information such as capacity information, job starts/completes, etc.
Notice	Sends a notification email if a non-critical error occurs. Refer to the <a href="#">“Notices”</a> section in chapter 13 for the list of events that will trigger this event notification. Notice reports will contain warnings such as something has failed, but the function or unit can continue operating as usual. It is recommended to perform the corrective action for the notice as soon as possible.
Error	Sends a notification email if a critical error occurs. Refer to the <a href="#">“Errors”</a> section in chapter 13 for the list of events that will trigger this event notification. Error reports will describe critical failures that prevented a function or unit from operating properly. It is recommended to perform the corrective action for the error immediately.

**5** Click *OK*. The process is complete once you close the confirmation window that appears.

## Sleep Mode

To save energy, you can specify times to put the TeraStation into sleep (standby) mode, during which the drives and LEDs are turned off.

**1** From Settings, click *Management*.



**2** Click the settings icon (  ) to the right of “Sleep Timer”.

 Sleep Timer 

**3** Click *Edit*.

**4** Specify the timer interval, wake-up time, and time to enter sleep mode, then click *OK*.

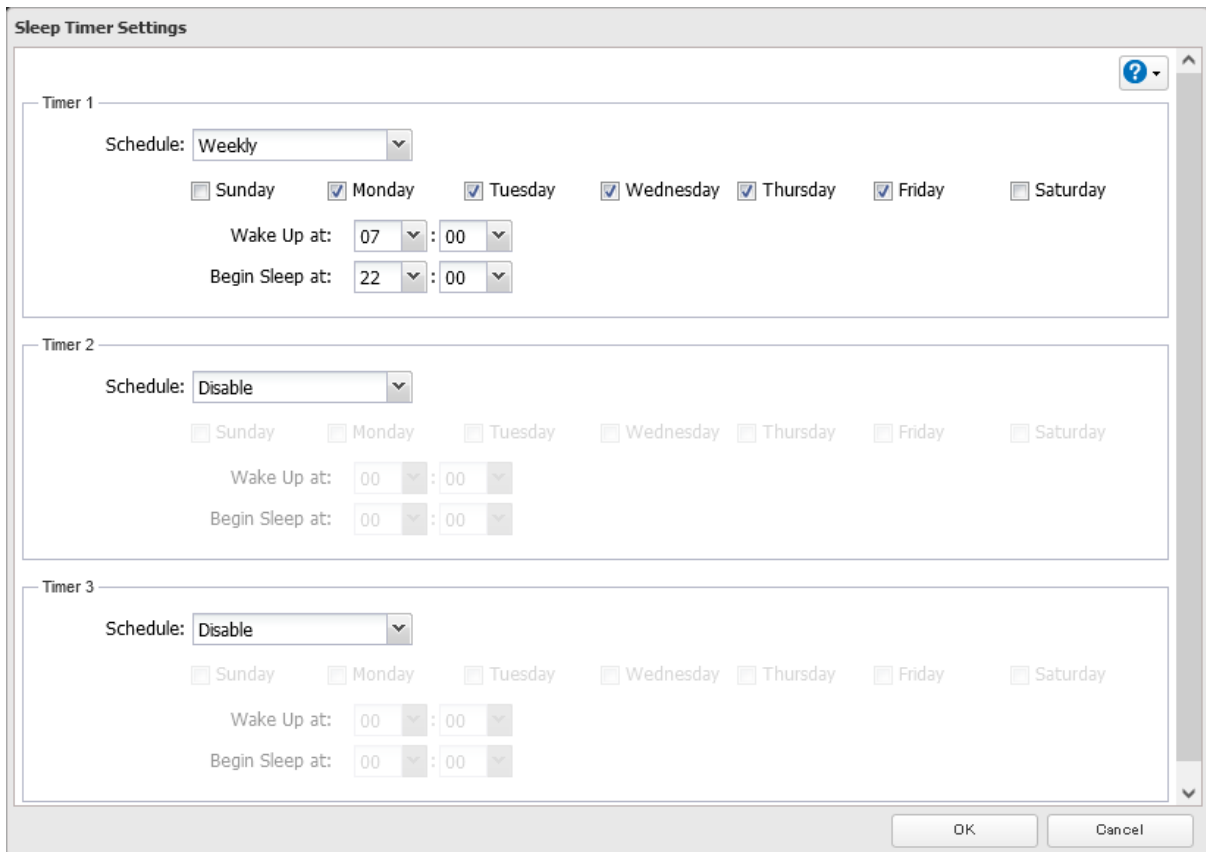

**Sleep Timer Settings**

Timer 1

Schedule: Weekly

Sunday  Monday  Tuesday  Wednesday  Thursday  Friday  Saturday

Wake Up at: 07 : 00

Begin Sleep at: 22 : 00

Timer 2

Schedule: Disable

Sunday  Monday  Tuesday  Wednesday  Thursday  Friday  Saturday

Wake Up at: 00 : 00

Begin Sleep at: 00 : 00

Timer 3

Schedule: Disable

Sunday  Monday  Tuesday  Wednesday  Thursday  Friday  Saturday

Wake Up at: 00 : 00

Begin Sleep at: 00 : 00

OK Cancel

**5** The process is complete once you close the confirmation window that appears.

#### Notes:

- Up to three timers can be set.
- The time to enter sleep mode can be set from 12:00 a.m. to 3:45 a.m. of the next day. The time to wake from sleep mode can be set from 12:00 a.m. to 11:45 p.m. If the time to enter sleep mode is after 12:00 a.m., the wake-up time setting may be from 4:00 a.m. to 11:45 p.m.
- The time to enter sleep mode should not be set to the same time as or earlier than the start time.
- If sleep mode timer is scheduled to go off while logging in to Settings, checking or formatting a drive, running a backup process, or setting a backup job within five minutes of the current time, the TeraStation will not enter sleep mode when the configured time is reached.
- If scheduled times in the timer overlap, the operation is performed using the widest time interval.
- Examples of timer settings are shown below:

- **Example 1:**

If running at a current time of 10:00 a.m. Wednesday

Timer 1: Daily 12:00–24:00

Timer 2: Not used

Timer 3: Not used

No operation is performed at 12:00 p.m. and the unit enters sleep mode at 12:00 a.m.

◦ **Example 2:**

If running at a current time of 10:00 a.m. Wednesday

Timer 1: Daily 9:00–18:00

Timer 2: Wednesday 10:00–20:00

Timer 3: Not used

On days other than Wednesday, normal operation begins at 9:00 a.m. and the unit enters sleep mode at 6:00 p.m. On Wednesday, the unit enters sleep mode at 8:00 p.m.

◦ **Example 3:**

If running at a current time of 10:00 a.m. Wednesday

Timer 1: Daily 9:00–18:00

Timer 2: Wednesday 10:00–1:00 a.m. of the next day

Timer 3: Not used

On days other than Wednesday, normal operation begins at 9:00 a.m. and the unit enters sleep mode at 6:00 p.m. On Wednesday, normal operation begins at 10:00 a.m. and the unit enters sleep mode at 1:00 a.m. of the next day.

◦ **Example 4:**

If running at a current time of 10:00 a.m. Wednesday

Timer 1: Daily 9:00–18:00

Timer 2: Wednesday 7:30–22:00

Timer 3: Not used

On days other than Wednesday, normal operation begins at 9:00 a.m. and the unit enters sleep mode at 6:00 p.m. On Wednesday, normal operation begins at 7:30 a.m. and the unit enters sleep mode at 10:00 p.m.

- To wake the TeraStation from sleep mode before the wake-up time, press and hold down the power button for three seconds.

---

## UPS (Uninterruptible Power Supply)

---

If a UPS (sold separately) is attached, the TeraStation can be automatically shut down to protect data in the event of a power outage.

The procedure to configure for a UPS device is different depending on how many power supply units are installed on your TeraStation. Depending on your setup, follow one of the procedures below for your TeraStation.

**Notes:**

- If the TeraStation is connected directly to a UPS, select “Sync with UPS connected to this TeraStation”. If a different Buffalo NAS device is connected to the UPS, select “Sync with UPS connected to another Buffalo NAS device on the same network”. After making this selection, enter the IP address of the Buffalo NAS device that will be the sync source into “Other Buffalo NAS's IP Address”.
- If you don't want to connect any UPS devices, select “Do not synchronize with UPS” and the operation for if a power supply failure occurred. If “Use last state” at “AC Power Recovery” is selected, the TeraStation will revert to the state before the power supply failure occurred. If “Stay off” is selected, the TeraStation will remain off even after the TeraStation shuts down due to the power supply failure.
- When the TeraStation restarts after an automatic shutdown such as from a power outage or power supply issue, verify that external power has been restored. If the TeraStation is turned on while it is still running on the UPS and external power has not been restored, the automatic shutdown will not be performed, even after the specified time elapses.
- If the power supply from the UPS to the TeraStation stops and restarts when UPS recovery is enabled, the TeraStation will automatically restart.

## One PSU Device Is Installed

- 1 Plug the power cable of the UPS to a wall socket.
- 2 Connect the power cable of the TeraStation to the UPS.
- 3 Connect the UPS and the TeraStation.
- 4 Turn on the UPS, then the TeraStation.
- 5 From Settings, click *Management*.

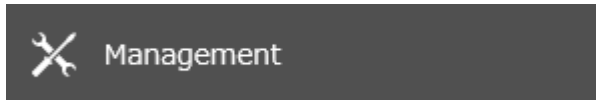

- 6 Click the settings icon (  ) to the right of "Power Management".



- 7 Click *Edit*.
- 8 Configure the desired settings, then click *OK*.

 A screenshot of the "Power Management Settings" dialog box. The title bar says "Power Management Settings" and has a red "\*Required" label and a help icon. The "UPS Sync Settings" tab is selected. Under "UPS Sync:", there are three radio button options:
 

- Sync with UPS connected to this TeraStation. This option is expanded to show:
  - UPS Connection Type: [dropdown menu]
  - Shutdown Will Occur If:  Power outages longer than 1 minutes;  UPS sends low battery signal.
  - Override Shutdown Conditions:  Delay shut down until the number of iSCSI connections reaches zero.
  - Shut Down UPS After TeraStation Shuts Down:  Yes;  No.
  - Wake Up TeraStation After Power Supply Recovers:  Yes;  No.
- Sync with UPS connected to another Buffalo NAS device on the same network. This option is greyed out and shows:
  - Other Buffalo NAS's IP Address \*: [text box]
  - Wake Up TeraStation After Power Supply Recovers:  Yes;  No.
- Do not synchronize with UPS. This option is greyed out and shows:
  - AC Power Recovery:  Use last state;  Stay off.

 At the bottom right are "OK" and "Cancel" buttons.

- 9 The process is complete once you close the confirmation window that appears.

## Two PSU Devices Are Installed

The TS51220RH TeraStation model supports multiple PSU device connections. Refer to the setups below for connection configurations.

### A. To Boot the TeraStation After the Power Supply Recovers (Recommended)

Connect both power cables of the TeraStation to a single UPS device.



### B. To Increase Redundancy for Power Failure

Connect one power cable of the TeraStation to the UPS device and the other to the wall socket. Use separate power supply systems to increase redundancy.

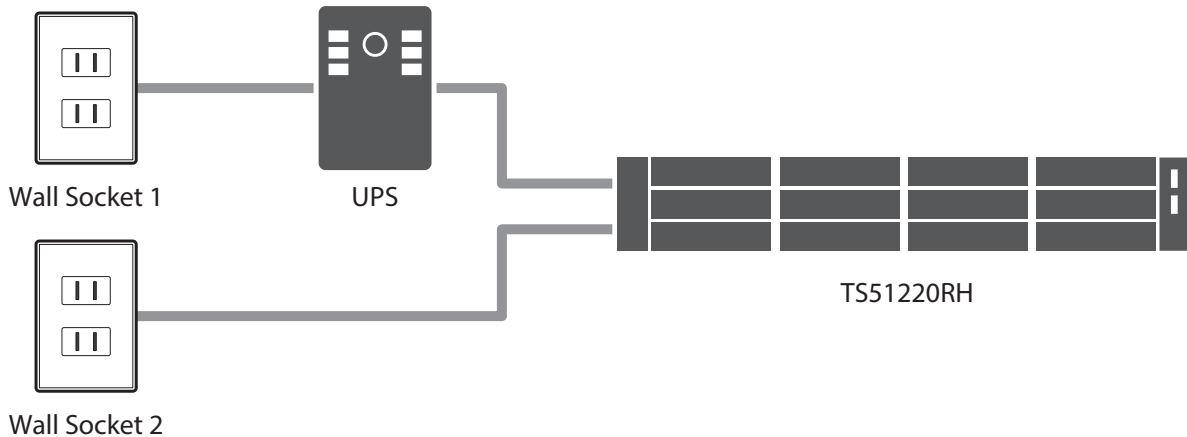

**Note:** With this connection setup, the option “Wake Up TeraStation After Power Supply Recovers” will not work if it’s configured.

### C. To Use Two UPS Devices

Connect a power cable to each of the UPS devices. Use separate power supply systems to increase redundancy. With this connection setup, the UPS devices of the same connection type cannot be used. One should be a USB, another should be a serial connection UPS device. The serial connection UPS device should be converted to a USB connection using a USB-to-serial converter cable.

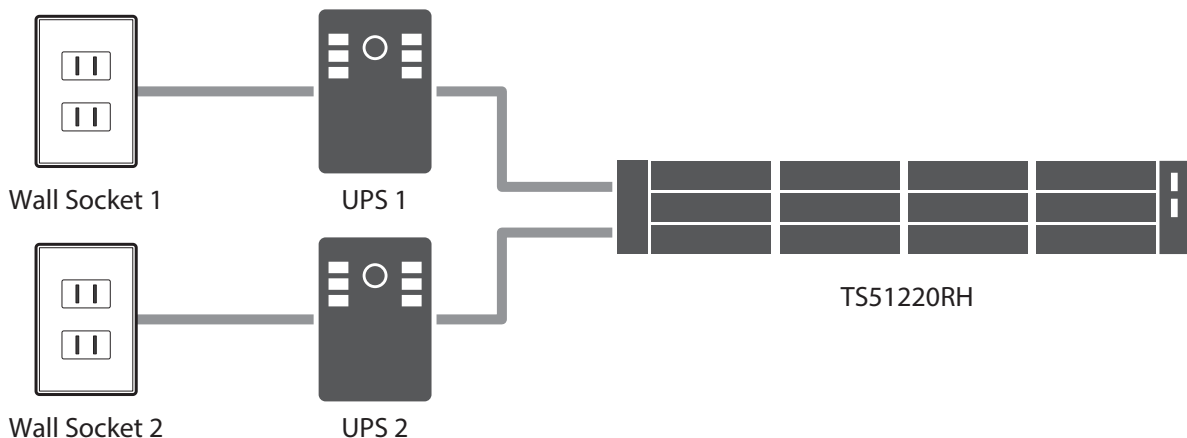

- 1 Connect the UPS device and the TeraStation as described above.
- 2 Turn on the UPS, then the TeraStation.
- 3 From Settings, click *Management*.

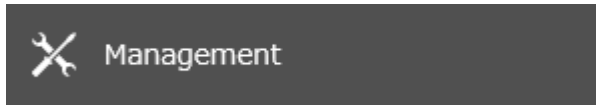

- 4 Click the settings icon (  ) to the right of "Power Management".

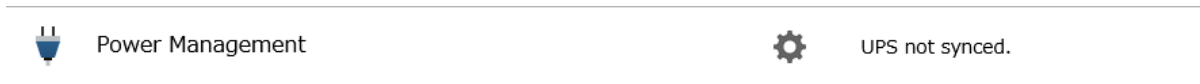

- 5 Click *Edit*.
- 6 Configure the desired settings, then click *OK*.

- 7 The process is complete once you close the confirmation window that appears.

## Automatic Shutdown If Power Supply Fails

You may configure the TeraStation to shut down automatically if a power supply fails.

**Note:** This function is only for the TS51220RH TeraStation model. Other models will not display this function on Settings.

- 1 From Settings, click *Management*.

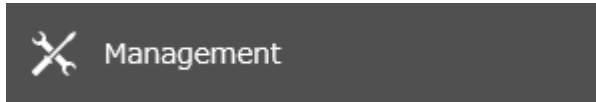

- 2 Click the settings icon (  ) to the right of "Power Management".



- 3 Click *Edit*.
- 4 Click the *Power Supply Failure Settings* tab.
- 5 Select "Shut down TeraStation" and enter the number of minutes that will elapse after the power supply fails before the unit shuts down.

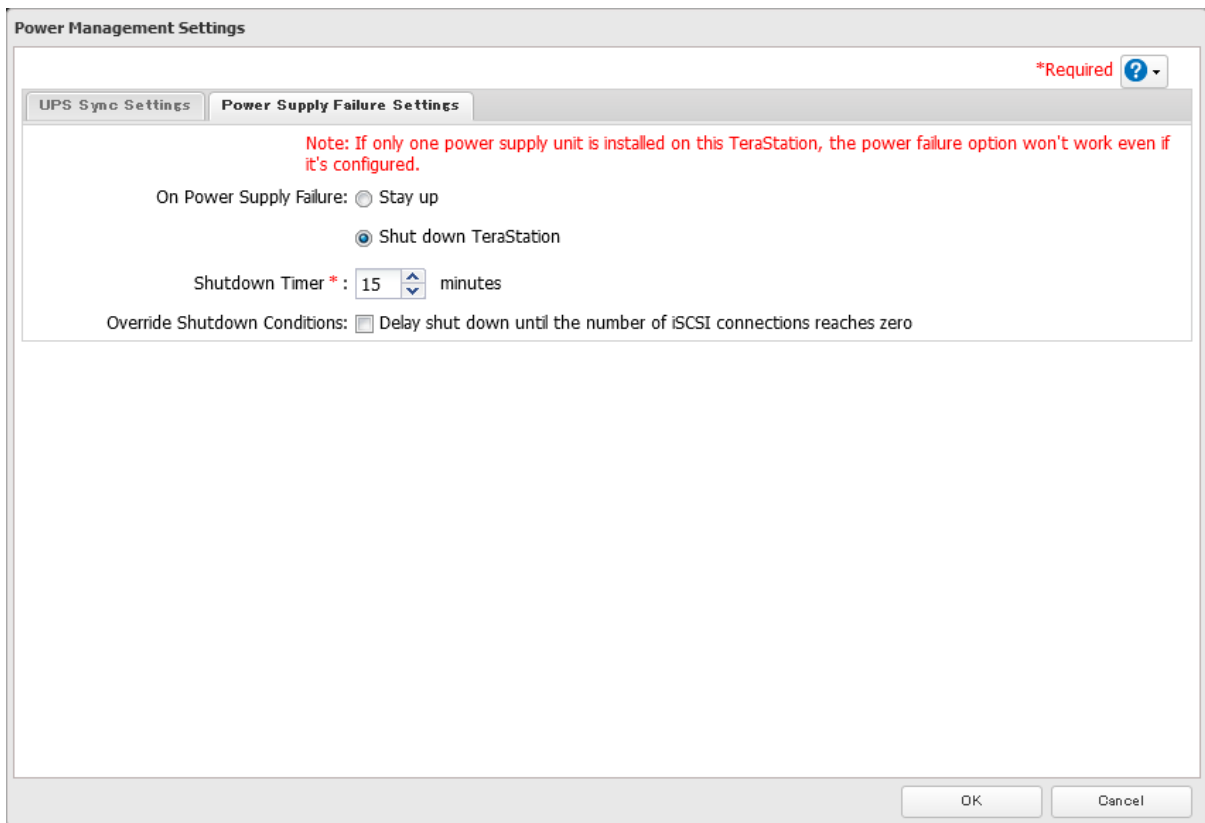

- 6 Click *OK*. The process is complete once you close the confirmation window that appears.

---

## Logs

---

### Displaying TeraStation's Logs

---

Follow the procedure to check the TeraStation's logs.

**1** From Settings, click *Management*.

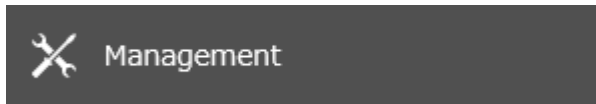

**2** Click the settings icon (  ) to the right of "Logs".



**3** Select a log to view.

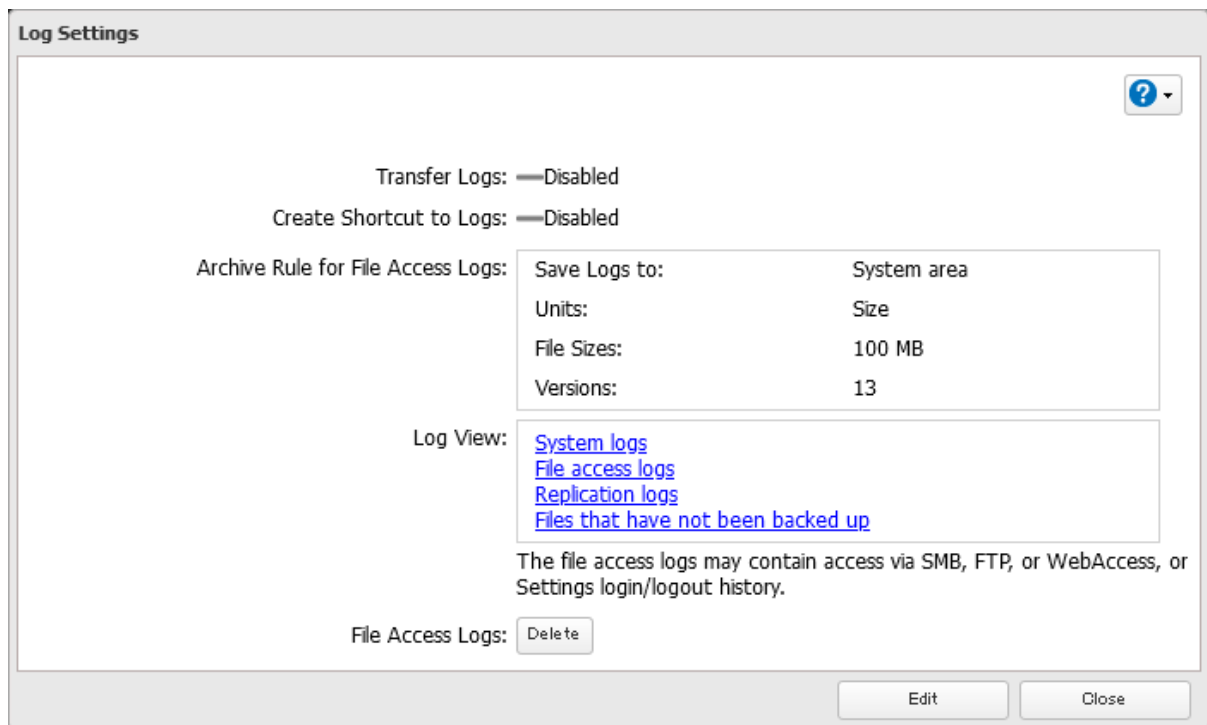

**Note:** The file access log stores file access events that occurred on the internal drives. File access on USB drives are not logged.

**4** The process is complete when the selected log is displayed.

**Note:** All logs are encoded in UTF-8 format. To make sure they display correctly, change the software encoding to "UTF-8".

## Transferring Logs to the Syslog Server

**1** From Settings, click *Management*.

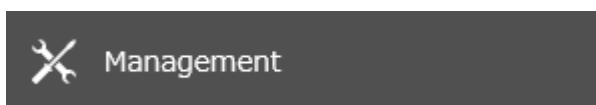

**2** Click the settings icon (  ) to the right of “Logs”.



**3** Click *Edit*.

**4** Enable “Syslog Transfer”.

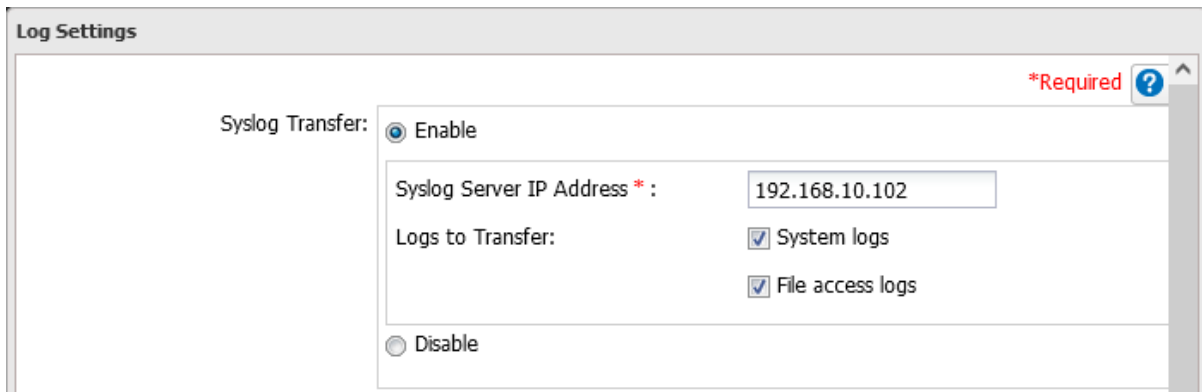

**5** Enter the IP address of the syslog server where you want to transfer the logs to.

**6** Select the type of log that you want to transfer from “Logs to Transfer” and click *OK*.

**7** The process is complete once you close the confirmation window that appears.

## Creating a Shortcut to the Logs in the Shared Folder

**1** From Settings, click *Management*.

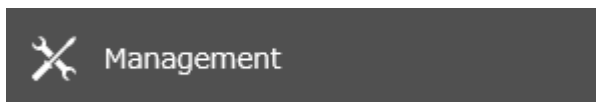

**2** Click the settings icon (  ) to the right of “Logs”.



**3** Click *Edit*.

**4** Enable “Create Shortcut to Logs”.



**5** Click *Browse* under “Target Folder” and select the shared folder where the created shortcut will lead, then click *OK*.

**6** The process is complete once you close the confirmation window that appears.

In the selected shared folder, a folder named “system\_log” will now contain the shortcuts to logs.

## Changing Archive Rules for File Access Logs

You can configure how many logs are kept or how long each log will be kept on the TeraStation.

**1** From Settings, click *Management*.



**2** Click the settings icon (  ) to the right of “Logs”.



**3** Click *Edit*.

**4** Specify the location and select the unit and version to save logs to the right of “Archive Rule for File Access Logs”. For example, if you select “Month” for the unit and enter “7” for the version, the file access logs for the next 7 months will be saved on the TeraStation.

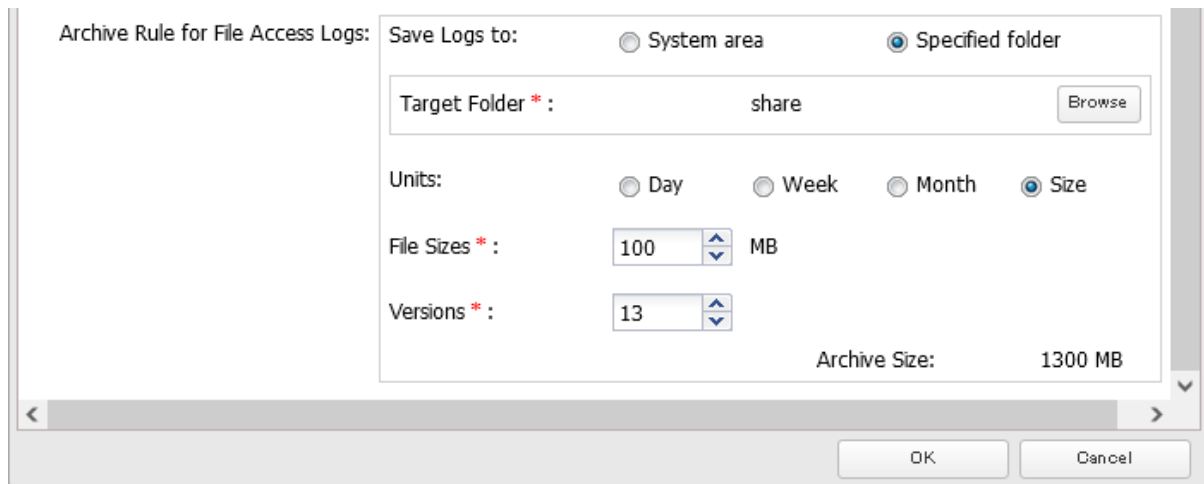

Available duration and capacity to save logs will vary depending on the unit. The following values are available:

- **Log destination is set to the system area**  
Unit (Size): 1–100 for file sizes and 1–13 for all versions
- **Log destination is set to a designated folder**
  - Unit (Day): 1–367 for all versions
  - Unit (Week): 1–53 for all versions
  - Unit (Month): 1–13 for all versions
  - Unit (Size): 1–100 for file sizes and 1–13 for all versions

**5** Click *OK*. The process is complete once you close the confirmation window that appears.

### Notes:

- To delete the saved logs, click *Delete* at the window in step 3.

- If there is not enough space to save logs, the **I70** message will appear as a notification. If it does, free up space by deleting the current file access logs. If no free space is made available elsewhere, older logs will automatically be deleted.
- If the shared folder to which logs are saved was created on a drive or RAID array, and that drive or RAID array is later changed using RMM, the log folder will be automatically changed to the system area. The **I72** message will also appear as a notification.
- You cannot delete a RAID array, format a drive, or change a folder name while file access logs are being saved to the shared folder.

---

## Updating the Firmware

---

If a new firmware version is available, a message is displayed when you access Settings. To either manually or automatically update the firmware, follow the appropriate procedure below.

### Notes:

- If all drives and RAID arrays on the TeraStation have LVM enabled but no LVM volumes have been created, you will not be able to update the firmware from Settings.
- Settings will not be available while the firmware is updating. Don't try to access Settings from another computer until the update is finished.

## Updating Manually Using Settings

---

To update the firmware from Settings, follow the procedure below. In such a case, you need free space of 2 GB or more on the TeraStation.

- 1** From Settings, click *Management*.

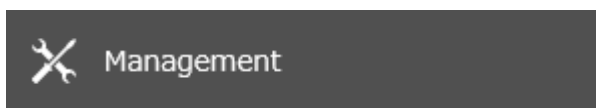

- 2** Click the settings icon (  ) to the right of "Update".

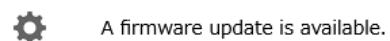

- 3** Click *OK*.

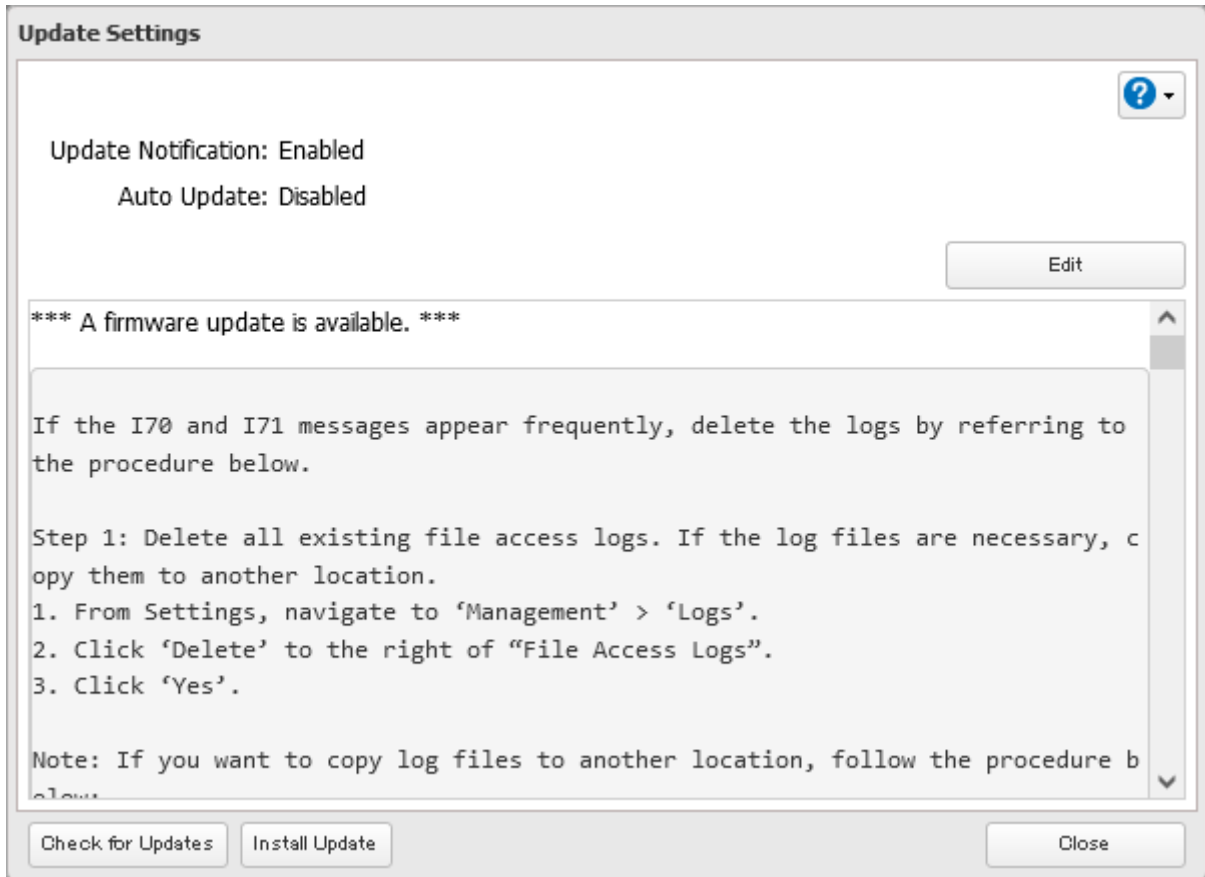
**4** Click *Install Update*.

**5** The “Confirm Operation” screen will open. Enter the confirmation number, then click *OK*.

**6** The process is complete once you close the confirmation window that appears. Refresh the browser and log in to Settings again.

You can also download the latest firmware from the [Buffalo website](#).

## Enabling Automatic Update

**1** From Settings, click *Management*.

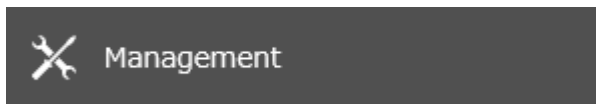

**2** Click the settings icon (  ) to the right of “Update”.



**3** Click *OK*.

**4** Click *Edit*.

- 5** Select either “Update the firmware automatically” or “Update the firmware on schedule”, then click *OK*.  
If you select to update on schedule, choose a specific time of day for the update to occur.

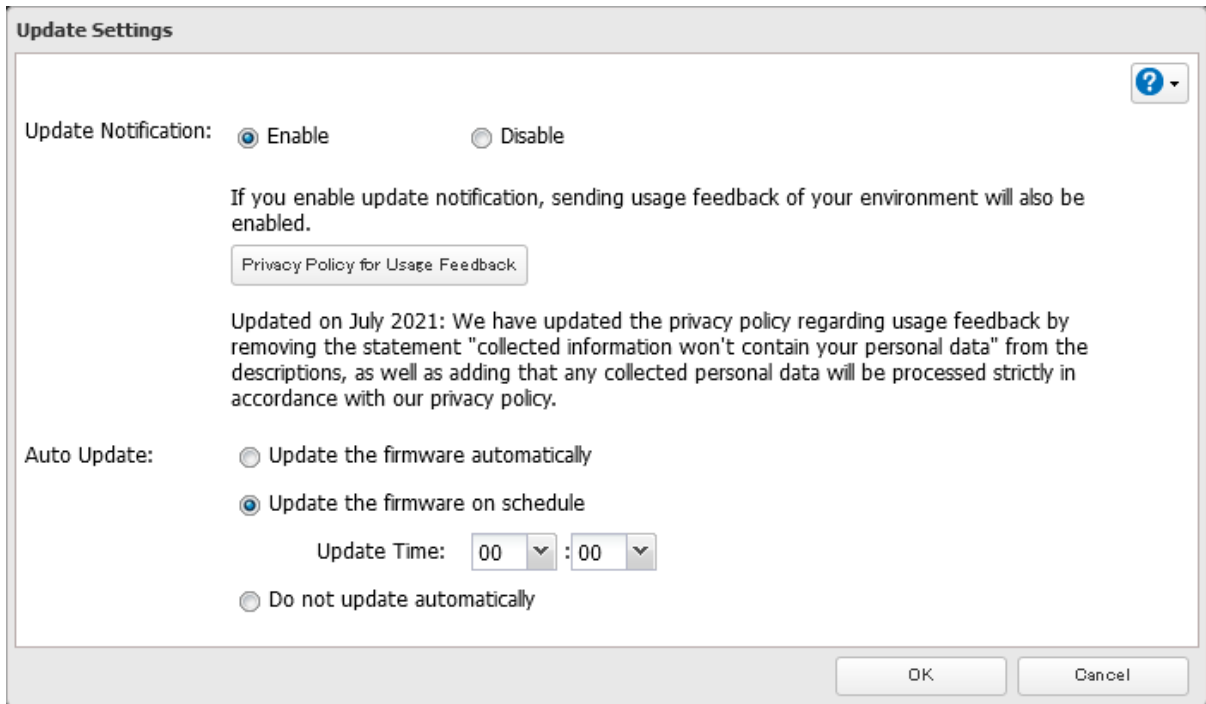

- 6** The process is complete once you close the confirmation window that appears.

## Configuring Update Notification

Configure whether or not to receive a notification when a new firmware version becomes available.

- 1** From Settings, click *Management*.

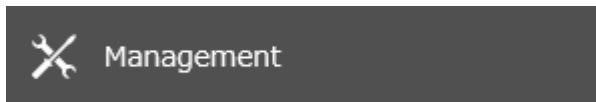

- 2** Click the settings icon (  ) to the right of “Update”.



- 3** Click *OK*.
- 4** Click *Edit*.

**5** Select to enable or disable update notification and click *OK*.

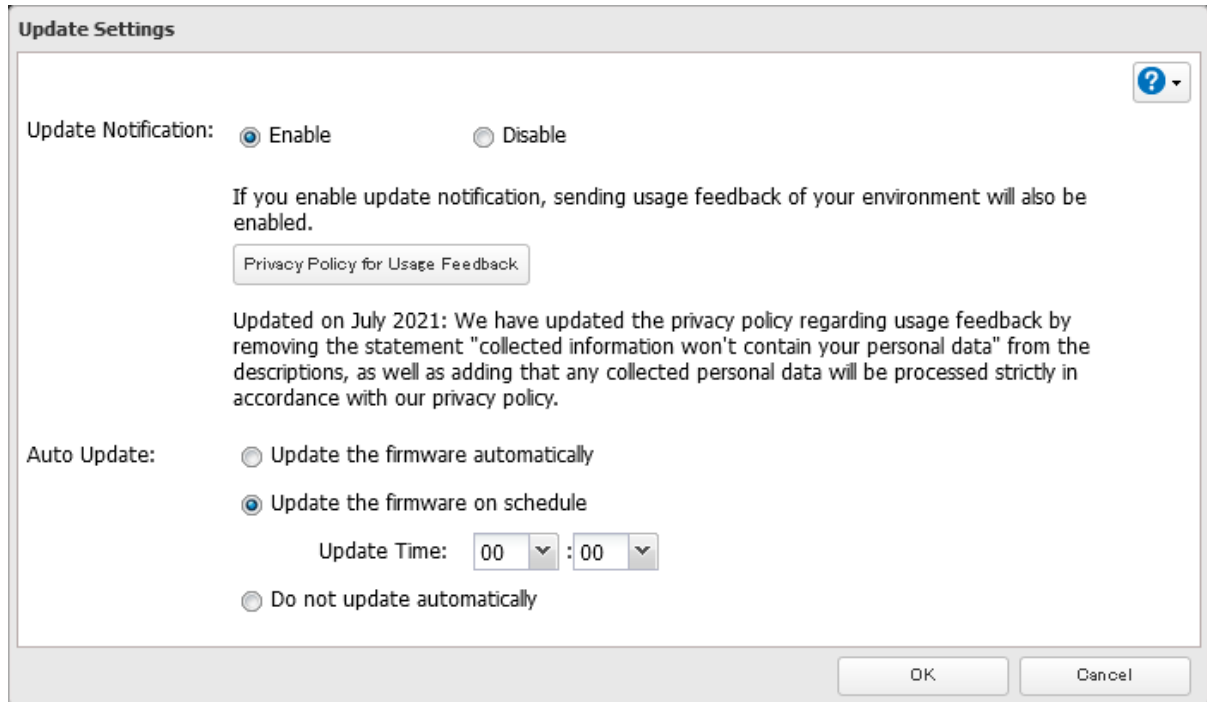

**6** The process is complete once you close the confirmation window that appears.

For further optimized firmware updates and product usability improvements, Buffalo may ask you to send your usage and environment information. For more details such as the information sent and how it will be handled by us, click *Privacy Policy for Usage Feedback*.

If update notification is enabled, it will also automatically enable sending usage feedback to Buffalo. If you don't want to send this information to us, disable update notification.

**Note:** If a backup job is running and the update time arrives, auto update will be skipped. After backup is finished, auto update will run at the next upcoming update time.

---

## Name, Date, Time, and Language

---

Configure the TeraStation's hostname, date, time, and language as shown below.

**Note:** To change the settings of a TeraStation that is being used as an iSCSI drive, navigate to *Storage > iSCSI* in Settings and move the iSCSI switch to the **off** position temporarily before changing settings.

**1** From Settings, click *Management*.



**2** Click the settings icon (  ) to the right of "Name/Time/Language".



**3** Click *Edit*.

#### 4 From the *Name* tab, enter the TeraStation's name and description.

The name will be used for identifying your TeraStation on the network. When your TeraStation is detected, the name will be used as the hostname. The hostname may contain up to 15 alphanumeric characters and hyphens (-). The first and last characters should not be a hyphen; do not use the following word as a hostname: localhost.

The screenshot shows the 'Name/Time/Language Settings' dialog box with the 'Name' tab selected. The 'Name' field contains 'TS5420D665' and the 'Description' field contains 'TeraStation'. There are 'OK' and 'Cancel' buttons at the bottom right. A '\*Required' indicator and a help icon are visible in the top right corner.

#### 5 Click the *Time* tab. Enable "Date/Time Source" and select the "Use default NTP server" checkbox. If you disable the NTP function, click *Use Local Date/Time* to use your computer's time settings for the TeraStation.

The screenshot shows the 'Name/Time/Language Settings' dialog box with the 'Time' tab selected. The 'Date/Time Source' section has the 'Enable' radio button selected. The 'NTP IP Address' field contains 'ntp.jst.mfeed.ad.jp', the 'Use default NTP server' checkbox is checked, and the 'NTP Synchronization Frequency' is set to 'Daily'. The 'Disable' section is dimmed, showing a date of '06/30/2022' and a time of '17:34:25' with a 'Use Local Date/Time' button. The 'Time Zone' dropdown is set to '(UTC) Coordinated Universal Time'. There are 'OK' and 'Cancel' buttons at the bottom right. A '\*Required' indicator and a help icon are visible in the top right corner.

By default, the TeraStation adjusts its clock automatically by using a default NTP server. This NTP server belongs to Internet Multi Feed Inc. For more information, visit <http://www.jst.mfeed.ad.jp>.

To use a different NTP server, clear the "Use default NTP server" checkbox and enter a new NTP IP address or its hostname, then click *OK*. If an NTP server is specified by name instead of IP address, make sure that a DNS server is configured for the TeraStation.

**Note:** The internal clocks of the TeraStation and other devices on your network may run at slightly different speeds. Over a long period of time, your network devices may show somewhat different times, which can cause network problems. If clocks on your network vary by more than five minutes, unexpected behavior may occur. For best results, keep all clocks on your network devices set to the same time by adjusting them regularly, or use an NTP server to correct them all automatically.

- 6** Click the *Language* tab and select the language to be used.

**Name/Time/Language Settings**

\*Required ?

Name Time **Language** Management Information

Character Encoding: CP437

Display Language: English

OK Cancel

**Note:** This tab changes the language used by the TeraStation for email notifications and other functions. To change the language displayed in Settings, go to Settings and click *Language* from the menu bar. Choose your desired language from the drop-down list.

- 7** Click the *Management Information* tab. Enter the desired location and administrator information.

**Name/Time/Language Settings**

\*Required ?

Name Time Language **Management Information**

Location:

Administrator:

OK Cancel

- 8** Click *OK* when all settings are configured.
- 9** The process is complete once you close the confirmation window that appears.

## Beep Alerts

You can set the TeraStation to beep if certain errors occur.

- 1** From Settings, click *Management*.

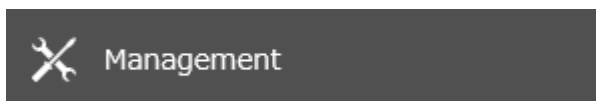

- 2** Click the settings icon (  ) to the right of "Notifications".



- 3** Click *Edit*.
- 4** Click the *Alert Sound* tab.

**5** Select the triggers to make the alert beep, then click *OK*.

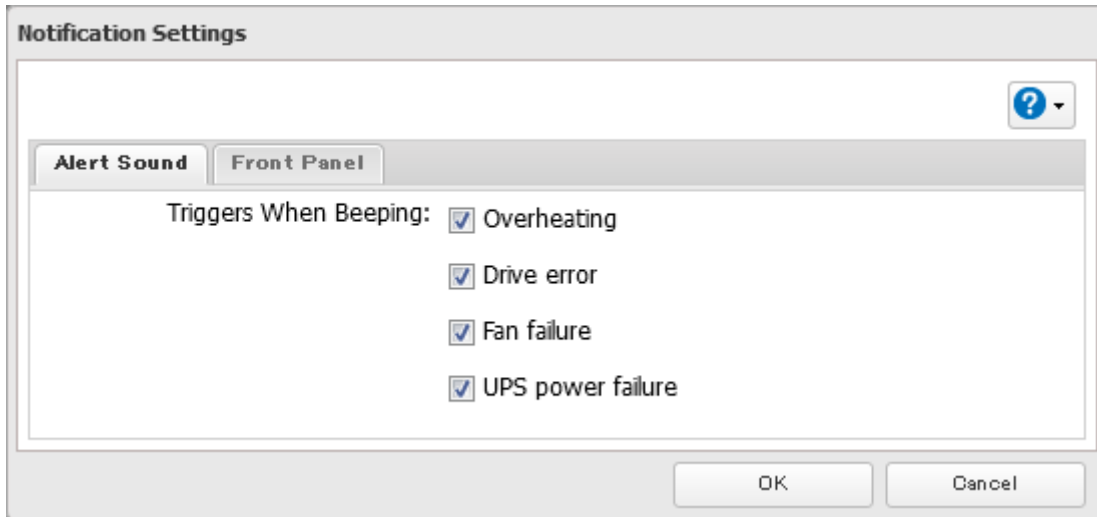

**6** The process is complete once you close the confirmation window that appears.

---

## LCD and LEDs

---

You may configure options for the LCD panel and adjust the brightness of the LCD panel and LEDs on the TeraStation.

**1** From Settings, click *Management*.



**2** Click the settings icon (  ) to the right of "Notifications".



**3** Click *Edit*.

- 4** From the *Front Panel* tab, configure your desired settings and click *OK*.

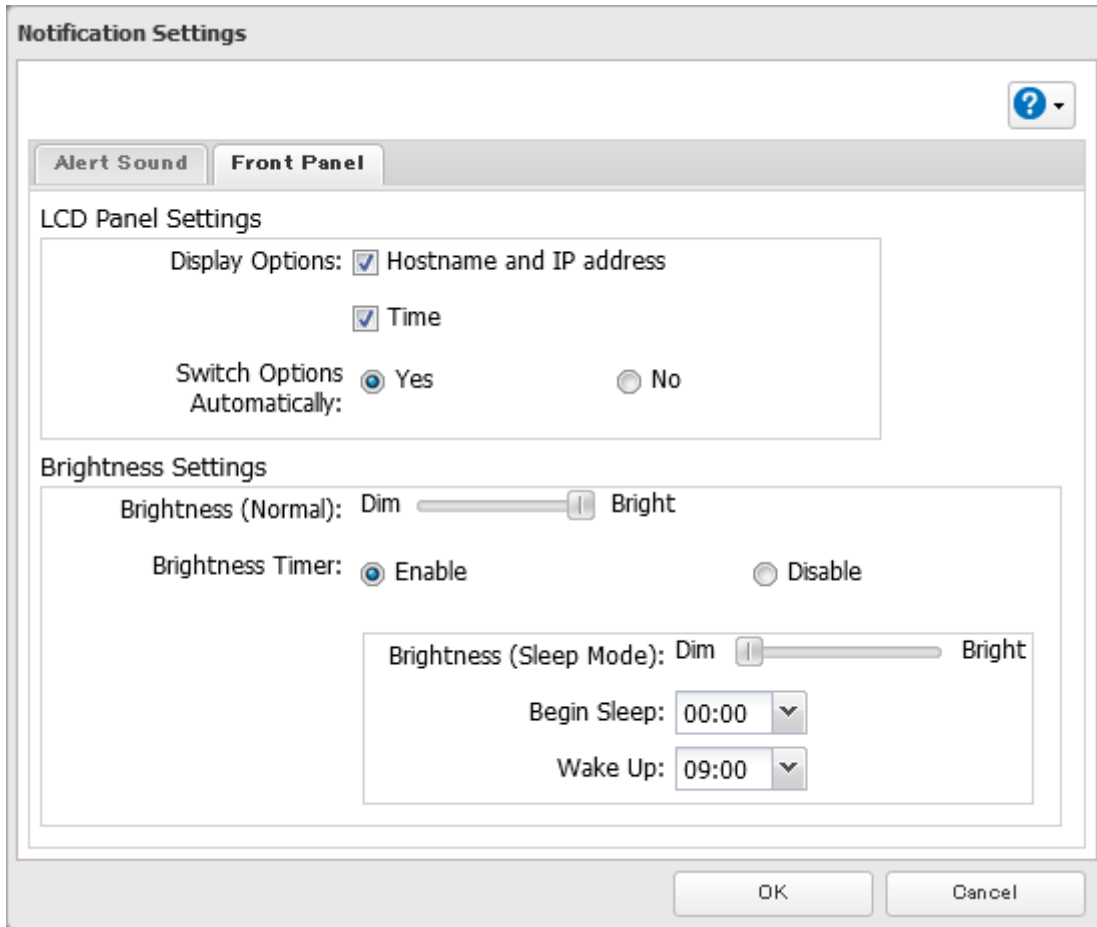

- 5** The process is complete once you close the confirmation window that appears.

# Chapter 11 Drive Replacement and Troubleshooting

Drive replacement procedures will vary depending on what RAID mode is configured for the TeraStation. Refer to the replacement procedure in the following sections corresponding to the configured RAID mode.

---

## Replacing a Defective Drive on the TS51220RH

---

### LEDs

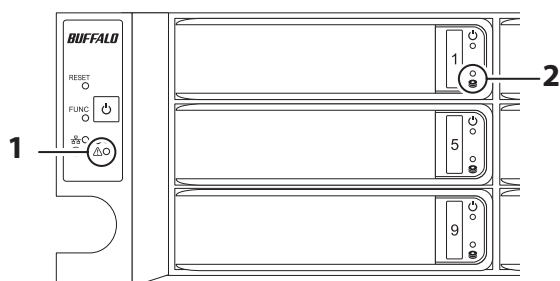

#### 1 Error LED

Glows red if a drive has failed.

#### 2 Drive Error LED

The failed drive's error LED will be blinking if the drive is still mounted. It will turn to a glowing red after the drive is dismantled.

### Notes

- Use a Buffalo OP-HDH2U series drive as the replacement drive. The replacement drive should be the same capacity or larger as the original drive. If a larger drive is used, the extra space will not be usable in a RAID array.
- To avoid damaging the TeraStation with static electricity, ground yourself by touching something made of metal before handling any sensitive electronic parts.
- After a drive is replaced, it will take about 30 minutes before normal file reading and writing operations are restored. Settings may not be accessible during this period.
- Do not change the order of the drives on the TeraStation. For example, pulling out the drive in slot 1 and replacing it with the drive in slot 2 may cause data to be corrupted or lost.
- If the LEDs do not change after a new drive is installed, click *Redetect Drive* in Settings.

## Drive Replacement for a Redundant RAID Array

---

If a drive used on a redundant RAID array fails, you need to recover the RAID array after replacing the defective drive to a new drive. Follow the appropriate procedure below to recover the RAID array.

- 1 Back up the saved data to another location before replacing the failed drive. If one or more drives fail during drive replacement, data can no longer be retrieved from the TeraStation.

- 2** The failed drive's error LED will be glowing red. Push its unlock button and swing the lock mechanism out. While the TeraStation's power is turned off, refer to the notification email sent by email notifications to determine which drive has failed.

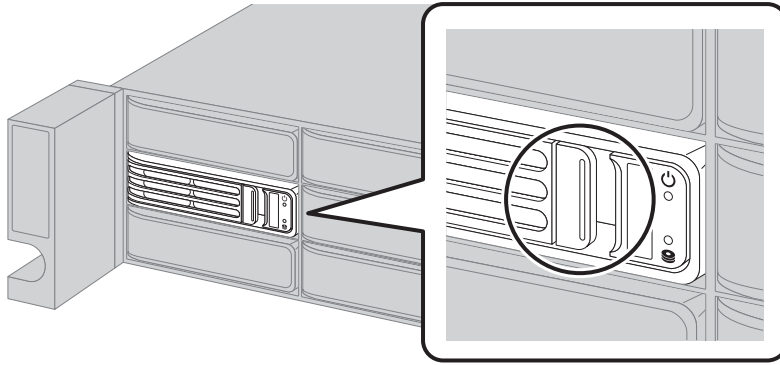

- 3** Pull out the drive cartridge and remove it from the TeraStation.

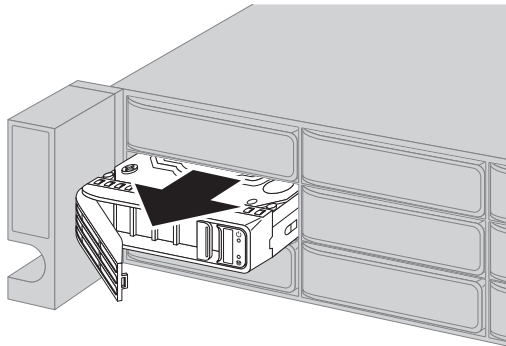

- 4** Insert the new drive into the empty slot with the lock mechanism remaining open.

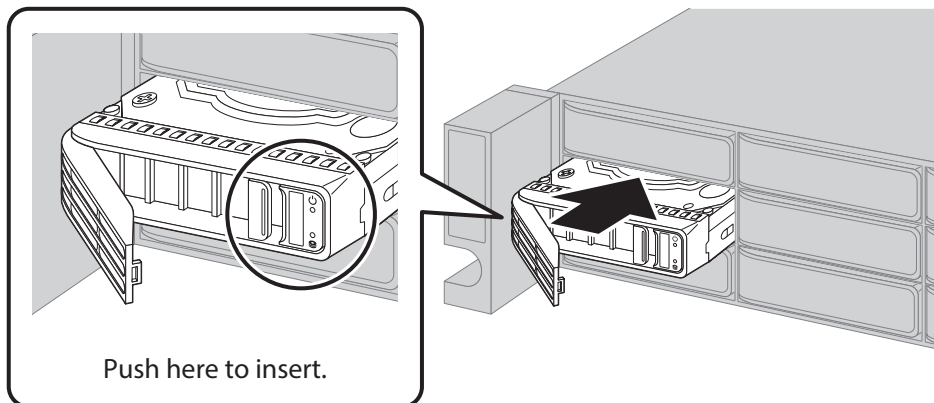

- 5** Swing the lock back down until it clicks into place.

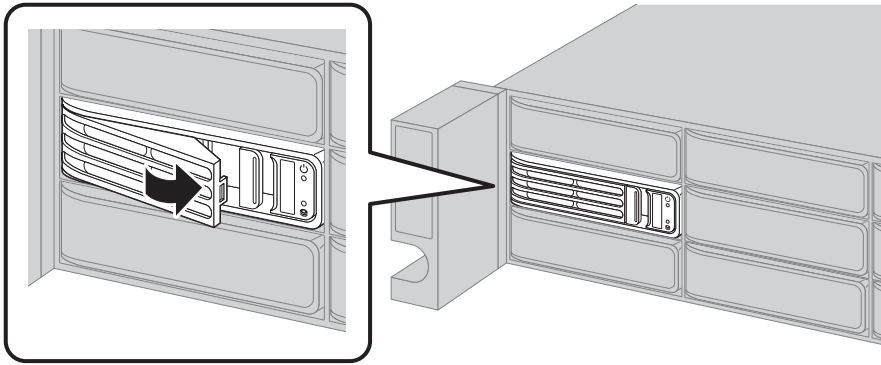

- 6** If the TeraStation's power is off, press the power button.
- 7** When the replaced drive is recognized, the error LED will blink and the **I31** message will appear as a notification.
- 8** The replaced drive will be rebuilt into the RAID array automatically when auto RAID rebuild is enabled. If not, you will have to rebuild the RAID array from Settings.
- (1) From Settings, navigate to *Storage > RAID*.
  - (2) Click the RAID array that held the failed drive, then select the replaced drive and click *Recover RAID Array*.
- 9** The RAID array recovery will begin. The **I18** message will appear as a notification after five minutes.
- 10** The process is complete when the **I18** message disappears.

## Drive Replacement for a RAID 0 Array

If a drive used in a RAID 0 array fails, you need to delete the RAID array, format the replaced drive, then create a RAID 0 array again after replacing the defective drive to a new drive.

**Note:** If a drive malfunctions in a RAID 0 array, all data on the RAID array will be lost. All of the settings for the shared folders (such as access restrictions) are erased after replacing a drive from a RAID 0 array.

- 1** Dismount the drive with the blinking error LED by referring to the ["Using Settings"](#) section in chapter 4.
- 2** The error LED will stop blinking and glow steadily. Push its unlock button and swing the lock mechanism out.
- 3** Pull out the drive cartridge and remove it from the TeraStation.
- 4** Insert the new drive into the empty slot with the lock mechanism remaining open.
- 5** Swing the lock back down until it clicks into place.
- 6** When the replaced drive is recognized, the error LED and drive status LED will blink alternately and the **I31** message will appear as a notification.
- 7** Delete the RAID array that held the failed drive by referring to the ["Using JBOD"](#) section in chapter 4.
- 8** Format the replaced drive by referring to the ["Formatting Drives"](#) section in chapter 4.
- 9** Create a new RAID 0 array by referring to the ["Creating a RAID Array"](#) section in chapter 4.

The new RAID 0 array will be created. Next, create a shared folder by referring to the [“Adding a Shared Folder”](#) section in chapter 3.

## Drive Replacement for a JBOD

---

If a drive used as JBOD fails, you need to format the replaced drive after replacing the defective drive to a new drive.

- 1** The failed drive’s error LED will be glowing red. Push its unlock button and swing the lock mechanism out.
- 2** Pull out the drive cartridge and remove it from the TeraStation.
- 3** Insert the new drive into the empty slot with the lock mechanism remaining open.
- 4** Swing the lock back down until it clicks into place.
- 5** When the replaced drive is recognized, the error LED will blink and the **I31** message will appear as a notification.
- 6** Format the replaced drive by referring to the [“Formatting Drives”](#) section in chapter 4.

The drive will be formatted. Next, create a shared folder by referring to the [“Adding a Shared Folder”](#) section in chapter 3.

## Drive Replacement for a Hot Spare

---

If your TeraStation’s drives are in a redundant RAID mode and you have a hot spare enabled, a malfunctioning drive in the array is replaced with a hot spare and the RAID array is rebuilt automatically. The error LED will continue to glow red for the failed drive even after the RAID array is rebuilt with the hot spare. After you replace the failed drive with a new drive, follow the procedure below to configure the new drive as a hot spare.

- 1** The failed drive’s error LED will be glowing red. Push its unlock button and swing the lock mechanism out.
- 2** Pull out the drive cartridge and remove it from the TeraStation.
- 3** Insert the new drive into the empty slot with the lock mechanism remaining open.
- 4** Swing the lock back down until it clicks into place.
- 5** When the replaced drive is recognized, the error LED will blink and the **I31** message will appear as a notification.
- 6** Press the function button.
- 7** The process is complete when the TeraStation beeps. The replaced drive will be automatically registered as a hot spare.

To use the replaced drive as a normal drive rather than a hot spare, navigate to *Storage > RAID* and click the RAID array, select the new drive, and click *Set as a normal drive*.

---

## Replacing a Defective Drive on Models Other Than the TS51220RH

---

The following drive replacement examples use the case of the TS5420DN TeraStation model.

## LEDs

Drives on the TeraStation will have its status LED glow green during normal operation. If a drive fails, its error LED will glow red.

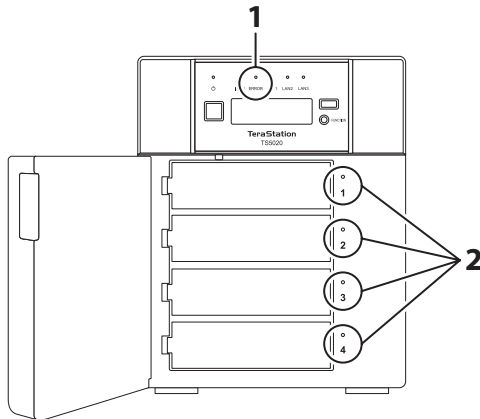

### 1 Error LED

Glowes red if a drive has failed.

### 2 Status LEDs

The failed drive's status LED will be glowing a steady red. A drive with a red status LED is ready to hot-swap.

## Notes

- Do not unplug a drive whose status LED is green instead of red. Dismount it first or shut down the TeraStation before swapping a working drive. If you remove the drive without properly dismounting it, data may be lost and the TeraStation may malfunction.
- Use a Buffalo OP-HDN series drive as the replacement drive. The replacement drive should be the same capacity or larger as the original drive. If a larger drive is used, the extra space will not be usable in a RAID array.
- To avoid damaging the TeraStation with static electricity, ground yourself by touching something made of metal before handling any sensitive electronic parts.
- After a drive is replaced, it will take about 30 minutes before normal file reading and writing operations are restored. Settings may not be accessible during this period.
- Do not change the order of the drives on the TeraStation. For example, pulling out the drive in slot 1 and replacing it with the drive in slot 2 may cause data to be corrupted or lost.
- If the LCD panel does not change after a new drive is installed, click *Redetect Drive* in Settings.

## Drive Replacement for a Redundant RAID Array (TeraStation Is On)

If a drive used on a redundant RAID array fails, you need to recover the RAID array after replacing the defective drive to a new drive. If a drive used as JBOD fails, you need to format the replaced drive after replacing the defective drive to a new drive.

Follow the procedure below to recover the RAID array. If replacing multiple malfunctioning drives at once, refer to the ["Drive Replacement for a Redundant RAID Array \(TeraStation Is Off\)"](#) section.

- 1 Back up the saved data to another location before replacing the failed drive. If one or more drives fail during drive replacement, data can no longer be retrieved from the TeraStation.

**2** Open the front cover with the included key.

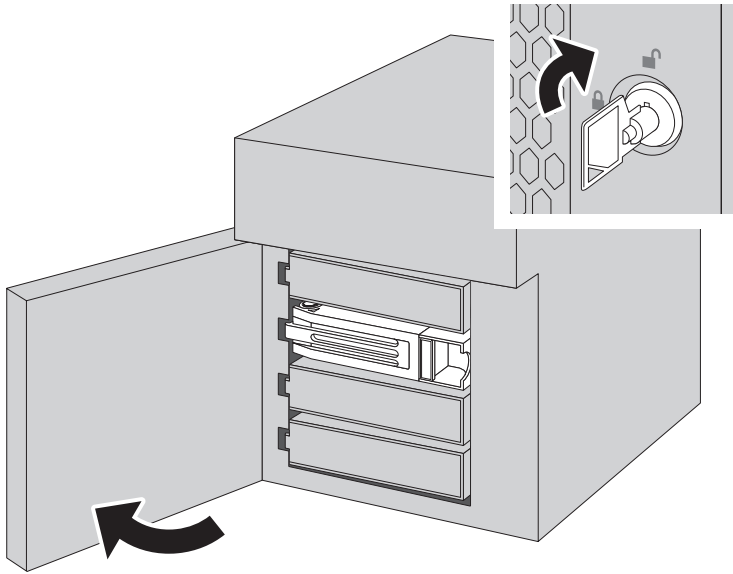

**3** The failed drive's status LED will be glowing red. Push its unlock button and swing the lock mechanism out.

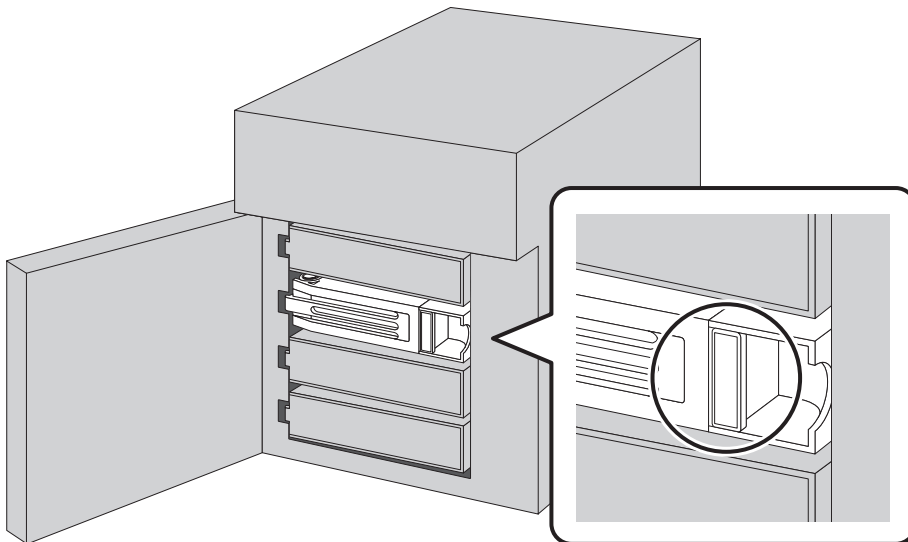

**Drives without red status LEDs lit are still on. Do not unplug or remove them.**

- 4** Pull out the drive cartridge and remove it from the TeraStation.

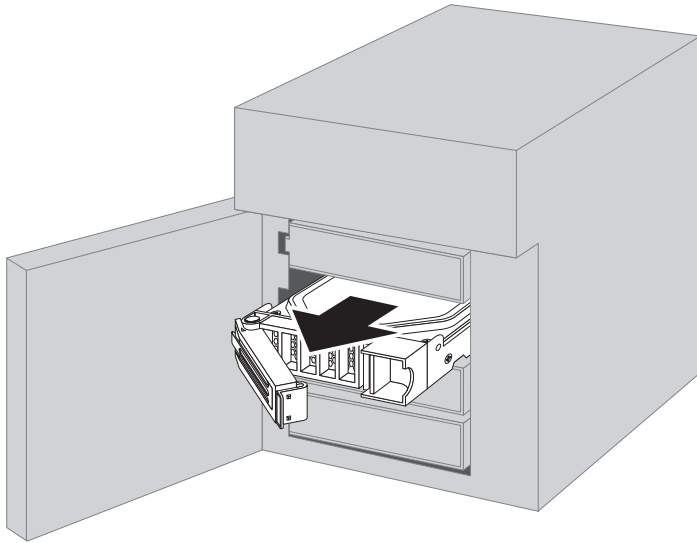

- 5** Insert the new drive into the empty slot with the lock mechanism remaining open.

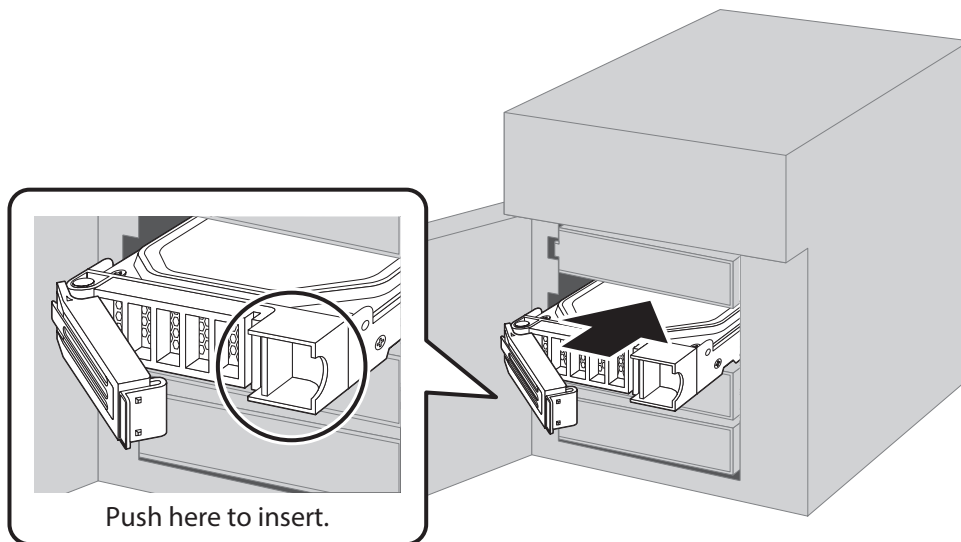

- 6 Swing the lock back down until it clicks into place.

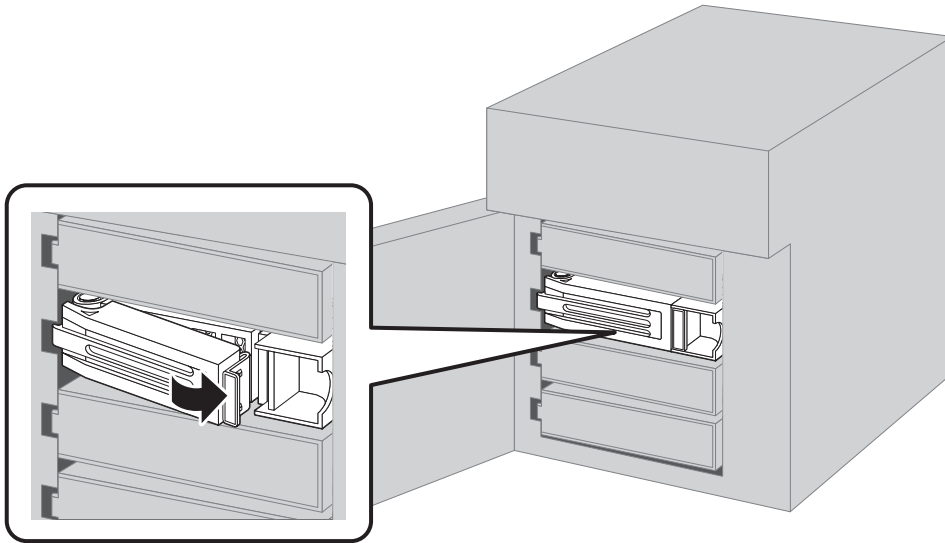

- 7 When the replaced drive is recognized, the status LED will flash red and the I31 message will appear as a notification.

- 8 Close the front cover.

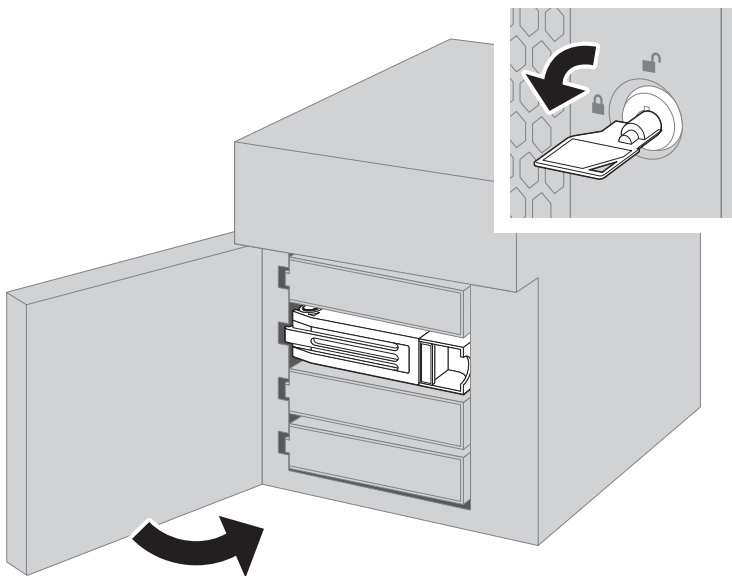

- 9 Press the function button. The TeraStation will beep once. Press and hold the button until the TeraStation beeps again.

- 10 The RAID array recovery will begin. The I18 message will appear as a notification after a few minutes. The process is complete when the I18 message disappears.

## **Drive Replacement for a Redundant RAID Array (TeraStation Is Off)**

If a drive used on a redundant RAID array fails, you need to recover the RAID array after replacing the defective drive to a new drive. If a drive used as JBOD fails, you need to format the replaced drive after replacing the defective drive to a new drive.

Follow the procedure below to recover the RAID array.

- 1** Back up the saved data to another location before replacing the failed drive. If one or more drives fail during drive replacement, data can no longer be retrieved from the TeraStation.
- 2** Open the front cover with the included key.
- 3** The failed drive's status LED will be glowing red. Push its unlock button and swing the lock mechanism out.
- 4** Pull out the drive cartridge and remove it from the TeraStation.
- 5** Insert the new drive into the empty slot with the lock mechanism remaining open.
- 6** Swing the lock back down until it clicks into place.
- 7** Press the power button on the TeraStation.
- 8** When the replaced drive is recognized, the status LED will flash red and the **I31** message will appear as a notification.
- 9** Close the front cover.
- 10** From Settings, navigate to *Storage > RAID*.
- 11** Click the RAID array that held the failed drive, then select the replaced drive and click *Recover RAID Array*.
- 12** The RAID array recovery will begin. The **I18** message will appear as a notification after a few minutes. The process is complete when the **I18** message disappears.

## **Drive Replacement for a RAID 0 Array**

---

If a drive used in a RAID 0 array fails, you need to delete the RAID array, format the replaced drive, then create a RAID 0 array again after replacing the defective drive to a new drive.

**Note:** If a drive malfunctions in a RAID 0 array, all data on the RAID array will be lost. All of the settings for the shared folders (such as access restrictions) are erased after replacing a drive from a RAID 0 array.

- 1** Turn off the TeraStation.
- 2** Open the front cover with the included key.
- 3** The failed drive's status LED will be blinking red. Push its unlock button and swing the lock mechanism out.
- 4** Pull out the drive cartridge and remove it from the TeraStation.
- 5** Insert the new drive into the empty slot with the lock mechanism remaining open.
- 6** Swing the lock back down until it clicks into place.
- 7** Press the power button on the TeraStation.
- 8** When the replaced drive is recognized, the status LED will flash red and the **I32** message will appear as a notification.
- 9** Close the front cover.

- 10** Delete the RAID array that held the failed drive by referring to the [“Using JBOD”](#) section in chapter 4.
- 11** Format the replaced drive by referring to the [“Formatting Drives”](#) section in chapter 4.
- 12** Create a new RAID 0 array by referring to the [“Creating a RAID Array”](#) section in chapter 4.
- 13** The process is complete once the new RAID 0 array is created. Next, create a shared folder by referring to the [“Adding a Shared Folder”](#) section in chapter 3.

## Drive Replacement for a JBOD

---

If a drive used as JBOD fails, you need to format the replaced drive after replacing the defective drive to a new drive.

**Note:** If a drive malfunctions in JBOD, all data on the drive will be lost.

- 1** Turn off the TeraStation.
- 2** Open the front cover with the included key.
- 3** The failed drive’s status LED will be blinking red. Push its unlock button and swing the lock mechanism out.
- 4** Pull out the drive cartridge and remove it from the TeraStation.
- 5** Insert the new drive into the empty slot with the lock mechanism remaining open.
- 6** Swing the lock back down until it clicks into place.
- 7** Press the power button on the TeraStation.
- 8** When the replaced drive is recognized, the status LED will flash red and the **I31** message will appear as a notification.
- 9** Close the front cover.
- 10** Format the replaced drive by referring to the [“Formatting Drives”](#) section in chapter 4.
- 11** The process is complete once the drive is formatted. Next, create a shared folder by referring to the [“Adding a Shared Folder”](#) section in chapter 3.

## Drive Replacement for a Hot Spare

---

If your TeraStation’s drives are in a redundant RAID mode and you have a hot spare enabled, a malfunctioning drive in the array is replaced with a hot spare and the RAID array is rebuilt automatically. The status LED will continue to glow red for the failed drive even after the RAID array is rebuilt with the hot spare. After you replace the failed drive with a new drive, follow the procedure below to configure the new drive as a hot spare.

- 1** Open the front cover with the included key.
- 2** The failed drive’s status LED will be glowing red. Push its unlock button and swing the lock mechanism out.
- 3** Pull out the drive cartridge and remove it from the TeraStation.
- 4** Insert the new drive into the empty slot with the lock mechanism remaining open.
- 5** Swing the lock back down until it clicks into place.

- 6** When the replaced drive is recognized, the status LED will flash red and the I31 message will appear as a notification.
- 7** Close the front cover.
- 8** Press the function button. The TeraStation will beep once. Press and hold the button until the TeraStation beeps again.
- 9** The process is completed once the replaced drive is set as a hot spare.

If you want to use the replaced drive as a normal drive rather than a hot spare, navigate to *Storage > RAID* and click the RAID array, select the new drive, and click *Set as a normal drive*.

---

## Replacing a Non-Malfunctioning Drive

---

If you must change a drive that is not malfunctioning, **shut down the TeraStation, then disconnect the drive.** A new drive should be inserted after turning on the TeraStation. Make sure that the startup process is successful by checking that the power LED changes to a steady green. If you need to replace more than one drive all at once, replace the drives one at a time to preserve your data. When replacing the non-malfunctioning drive, the RAID array will function as below:

### Operating in a Redundant RAID Array

If you are using a redundant RAID mode such as RAID 1, 5, or 6, the RAID array will enter degraded mode after replacing the drive. You will be unable to use the TeraStation until you recover the RAID array with a new drive.

### Operating in RAID 0

All data on the RAID array will be deleted after replacing the drive. You will be unable to use the TeraStation until you delete and create a new RAID array with a new drive.

### Operating in JBOD

All data on that drive will be deleted after replacing the drive. You will be unable to use the TeraStation until you format a new drive.

---

## Re-Inserting Drives

---

If the E14 or E16 error appears as a notification after initial bootup, follow the procedure below to re-insert the internal drives.

- 1** Turn off the TeraStation.
- 2** Open the front cover with the included key.

- 3** Push a drive's unlock button and swing the lock mechanism out.

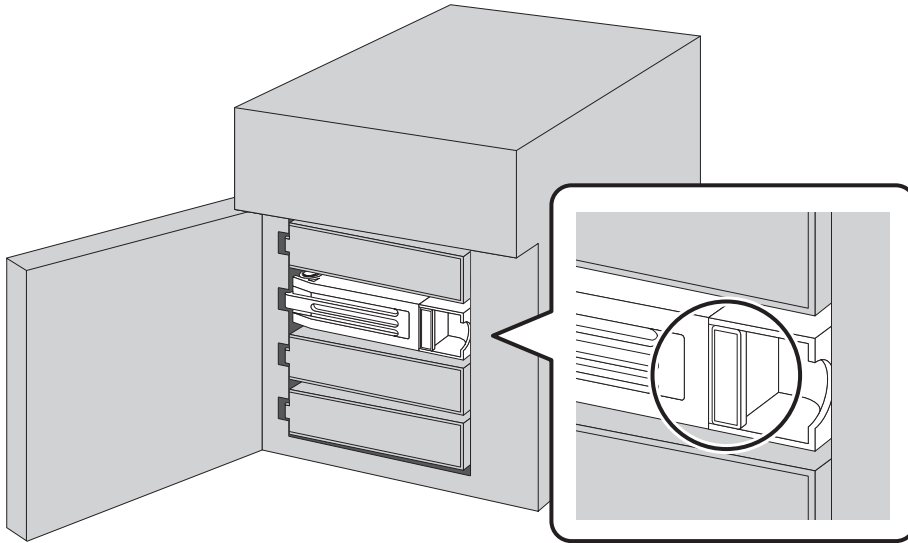

- 4** Pull out the drive cartridge and remove it from the TeraStation.

- 5** Insert the drive back into the same slot with the lock mechanism remaining open.

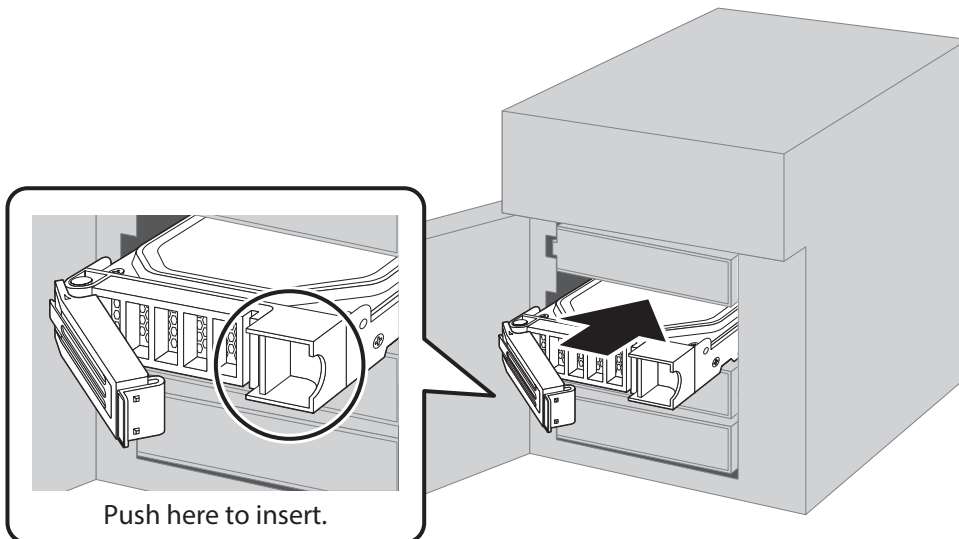

- 6** Swing the lock back down until it clicks into place.
- 7** Repeat steps 3–6 for all other installed drives.
- 8** Once every drive has been re-inserted, close the front cover.
- 9** Press the power button on the TeraStation.
- 10** The process is complete when any error messages disappear.

## TeraStation Does Not Work Properly

If an error occurs that prevents the TeraStation from booting up properly, one or more of the following symptoms may occur. In such a case, try the corresponding corrective action to recover from the error, described in each section below. If the error is still not resolved, contact Buffalo technical support for assistance.

- The power LED keeps blinking instead of turning into a solid glow; follow the procedure at the [“Power LED Keeps Blinking”](#) section below.
- An “i” symbol is displayed with the TeraStation icon and the I61 message appears as a notification; follow step 3 and after at the [“Power LED Keeps Blinking”](#) section below.
- An “i” symbol is displayed with the TeraStation icon and “EM” is added to your TeraStation’s hostname on NAS Navigator2; follow the procedure at the [“Booting the TeraStation in Emergency Mode”](#) section below.
- With the exception of the TS51220RH TeraStation model, the LCD panel lights up in red with the **Invalid Firmware** message; follow the procedure at the [“Booting the TeraStation in Emergency Mode”](#) section below.

### Power LED Keeps Blinking

While the TeraStation’s power LED keeps blinking, you may see the I61 message. In such a case, follow the procedure below to recover from drive setup mode.

- 1 Press and hold down the power button for three seconds to turn off the TeraStation.
- 2 Turn the TeraStation back on while holding down the function button. You should hold down the function button for at least 10 seconds after pressing the power button.
- 3 When the power LED changes from blinking to glowing, release the function button and open Settings from NAS Navigator2.
- 4 Make sure that “Recover firmware” is selected from the drop-down list under “Action”, then click *Start Setup*.

 Drive Setup
Unit Firmware Version : 1.00-2.22

Drive	Status	Info	Version	Model Name	Capacity	Primary Drive	Action
Drive 1	Recognized	System#1_(D:1/4)	1.00-2.22	ST1000VN002-2EY102	931 GB	<input checked="" type="radio"/>	Recover firmware ▾
Drive 2	Recognized	System#1_(D:2/4)	1.00-2.22	ST1000VN002-2EY102	931 GB		Recover firmware
Drive 3	Recognized	System#1_(D:3/4)	1.00-2.22	ST1000VN002-2EY102	931 GB		Recover firmware
Drive 4	Recognized	System#1_(D:4/4)	1.00-2.22	ST1000VN002-2EY102	931 GB		Recover firmware

Select the action to take when recovering the firmware.

Revert settings to those of the last shutdown  
This will revert settings to those that were saved before the last shutdown.

Revert settings to those of the last boot (Time When Boot Occurred: 06/21/2022 11:45:24)  
This will revert settings to those that were saved during the last boot.

No operations are required for the connected drives. Restart the TeraStation using the power button. However, if the TeraStation boots up in drive setup mode again, select “Recover firmware” under “Action”.  
To shut down the TeraStation, press and hold the power button for 3 seconds. Turn off the TeraStation before disconnecting any drives. Some settings may not work correctly when using drives that had been used with other series units and then not reformatted. For more detailed information, refer to the user manual.

Redetect Drive
Start Setup

**Note:** There are two more options for “Action” other than “Recover firmware”. The details for all options are below:

- **Use the drive's firmware:** The TeraStation will boot using the firmware on the drive.
- **Recover firmware:** The TeraStation will be recovered using the firmware on the NAND flash.
- **Format drive:** The drive will be formatted.

- 5 The “Confirm Operation” screen will open. Enter the confirmation number, then click *OK*.

- 6 The recovery process will start. When the process is finished, click *OK*.
- 7 The TeraStation will shut down automatically. Press the power button to turn it on.

The TeraStation will be recovered from the malfunction that is keeping the power LED blinking. Make sure the TeraStation finishes booting properly.

**Notes:**

- If the TeraStation does not recover from the error after trying the procedure above, try again from the first step.
- If the TeraStation did not power off properly in the previous shutdown, a message will appear in the window as below:

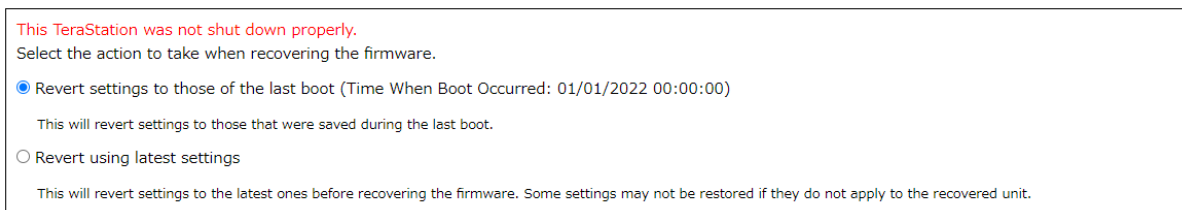

## Booting the TeraStation in Emergency Mode

If the TeraStation boots up in emergency mode, depending on your TeraStation model, an “i” symbol is displayed with the TeraStation icon and “EM” is added to your TeraStation’s hostname, or the LCD panel lights up in red with the **Invalid Firmware** message.



To recover from emergency mode, follow the procedure below.

- 1 Download the firmware updater from the [Buffalo website](#).
- 2 Extract the downloaded file by double-clicking it and launch the updater.
- 3 Update the firmware for the TeraStation unit that is currently in emergency mode.

When the “i” symbol and “EM” disappear from the icon and the hostname on NAS Navigator2, and the LCD panel returns to glowing blue, the TeraStation is no longer in emergency mode.

**Note:** If the TeraStation does not shut down properly due to a power outage or the power cable getting disconnected while the TeraStation is on, data on the TeraStation may be corrupted when the TeraStation boots in emergency mode. In such a case, the corrupted data may not be recoverable even if you try the procedure above.

## Unable to Access Shared Folders

If you cannot access a shared folder, check the following aspects:

- The logged-in user information has been added to Windows network credentials.
- The folder owner and access permissions have been configured properly.

- The SMB protocol is suited to your environment.

To configure the TeraStation to have the network credentials window appear when accessing a shared folder, refer to the [“Opening the Network Credentials Window”](#) section. If the folder owner and access permissions have accidentally been changed to incorrect parameters, restore them by referring the [“Restoring Owner and Permission Settings”](#) section. If you have changed the SMB protocol settings from the factory default value (“Auto”), refer to the [“Configuring Compatible SMB Protocols”](#) section.

## Opening the Network Credentials Window

Due to security reasons, you may be unable to access shared folders from computers running certain Windows versions. In such a case, follow the procedure below to change the TeraStation settings so you can be prompted to enter a Windows credential.

- 1 From Settings, click *File Sharing*.

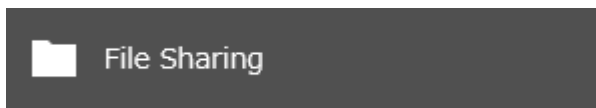

- 2 Click the settings icon (  ) to the right of “SMB”.



- 3 Click *Edit*.

- 4 Change the “Network Credentials” option to “Show network credentials window”, then click *OK*.



- 5 The process is complete when the file sharing menu list is displayed.

The settings are now changed. A window to enter a username and password will appear the next time you access a shared folder but fails.

## Restoring Owner and Permission Settings

If you changed the owner to an unexpected user or accidentally lost permissions to a specific folder, you can follow the procedure below to restore them.

- 1 From Settings, click *File Sharing*.



**2** Click the settings icon (  ) to the right of "Folder Setup".



**3** Click *Advanced Settings for Subfolders*.

The screenshot shows a window titled "Shared Folder List" with a table of folders. The table has columns for Name, Description, Drive/Array / Available Capacity, Quota, Snapshot, and Access Restrictions. The 'share' folder is selected, indicated by a checkbox and a blue underline. Below the table, there are navigation controls including "Page 1 of 1", "1-2 of 2", and "Items per page: 20". At the bottom, there are buttons for "Select All on This Page", "Select All Including Another Page", "Deselect All", "Advanced Settings for Subfolders", and "Close".

Name	Description	Drive/Array / Available Capacity	Quota	Snapshot	Access Restrictions
<a href="#">usbdisk1</a>	USB Drive 1	USB Drive 1 / 0.4 GB	- GB	—	—
<input checked="" type="checkbox"/> <a href="#">share</a>		Array 1 / 16667.5 GB	- GB	<a href="#">1</a>	—

#### 4 Select a folder to restore permissions from the tree.

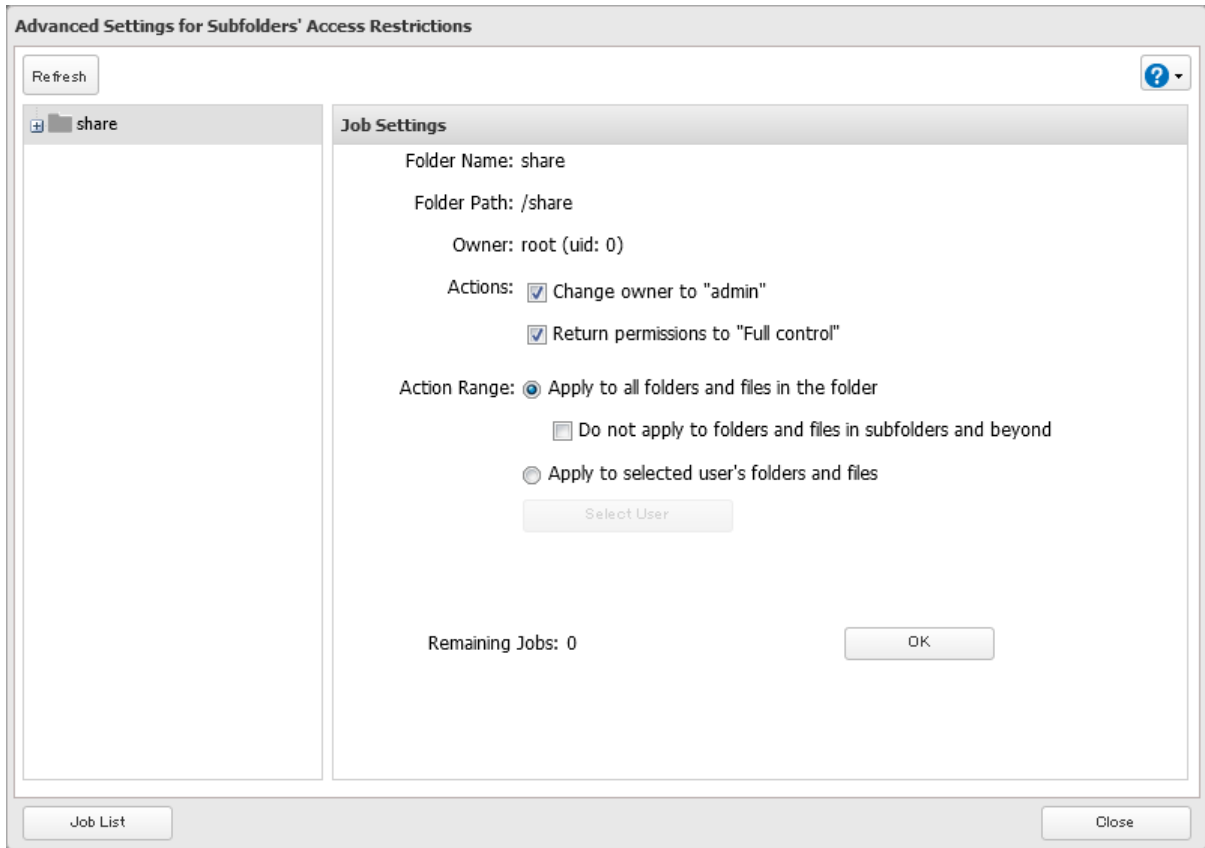

**Note:** If you select a root shared folder from the tree, the action will not apply to the recycle bin. To apply the action to the recycle bin, select it instead.

#### 5 Select the actions and action range to run, then click *OK*.

#### 6 The “Confirm Operation” screen will open. Enter the confirmation number, then click *OK*.

#### 7 The process is complete once you close the confirmation window that appears.

## Configuring Compatible SMB Protocols

You can change the SMB protocols that the TeraStation supports depending on the environment of your SMB clients.

**Note:** If you select SMB2 for this setting, the TeraStation will not be accessible from a client that uses SMB 2.0 protocol. In such a case, access the TeraStation from an SMB 2.1 protocol client or change the compatible SMB version.

#### 1 From Settings, click *File Sharing*.

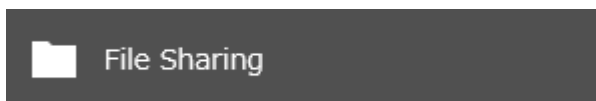

#### 2 Click the settings icon ( ) to the right of “SMB”.



- 3 Click *Edit*.
- 4 Change the “Protocol Selection” option to “Manual”.

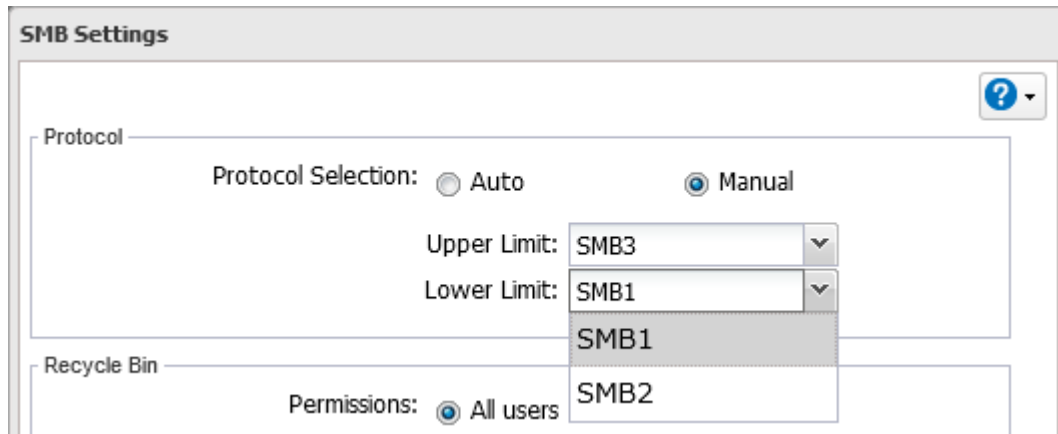

- 5 Select the upper and lower SMB protocols and click *OK*.
- 6 The process is complete when the file sharing menu list is displayed.

---

## Cleaning the Dustproof Filter

---

If your TeraStation has a front cover and you are trying to clean the dustproof filter on the front cover, follow the procedure below.

- 1 Open the front cover with the included key.

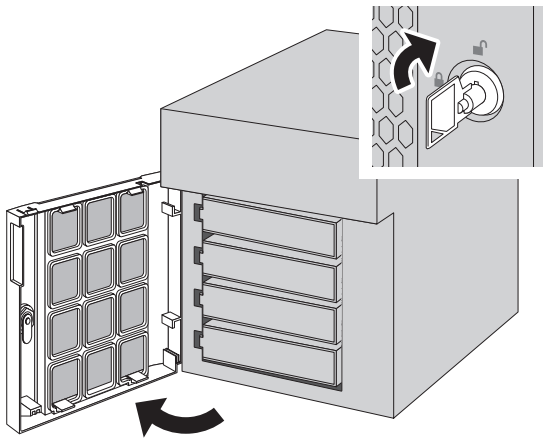

**2** Remove the front cover while holding the hook downward.

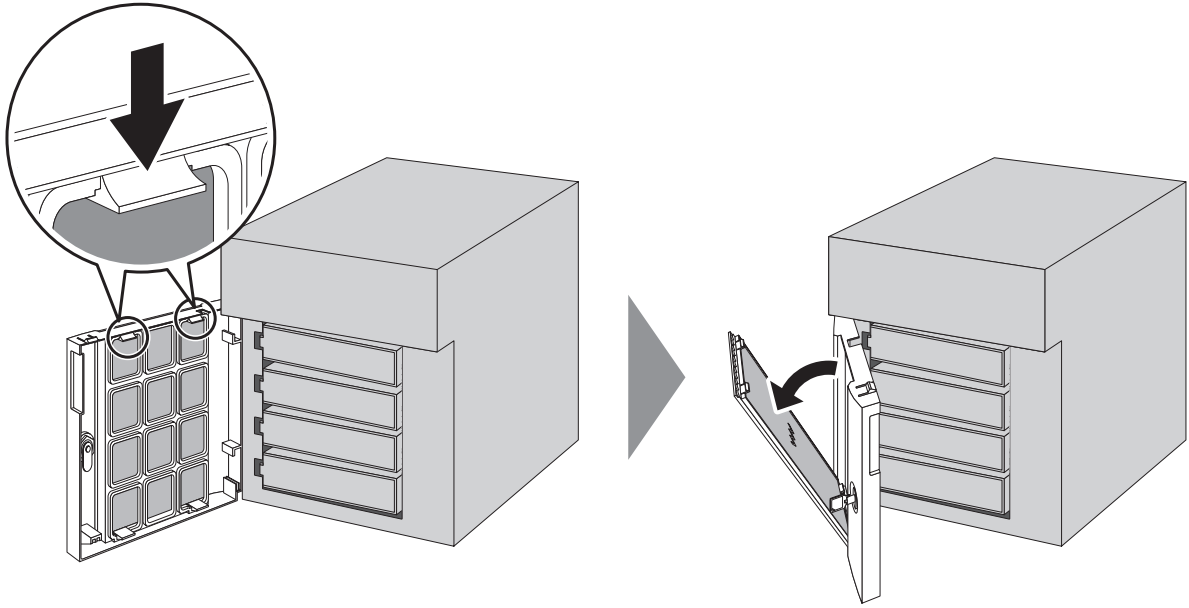

**3** Remove the dustproof filter from the front cover and clear any dust, such as by using a vacuum cleaner.

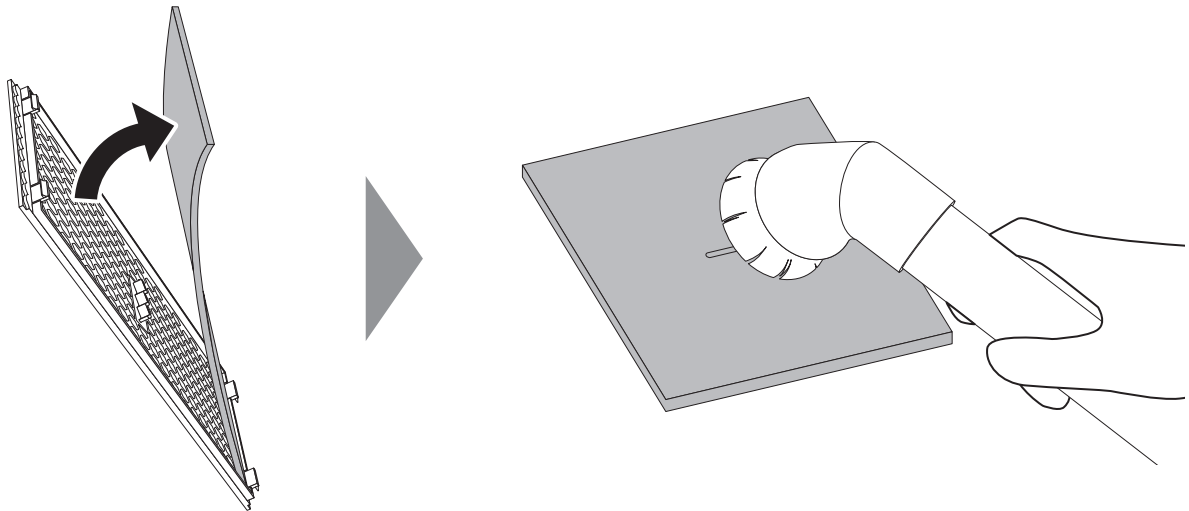

**4** When cleaning is finished, return the filter and the front cover.

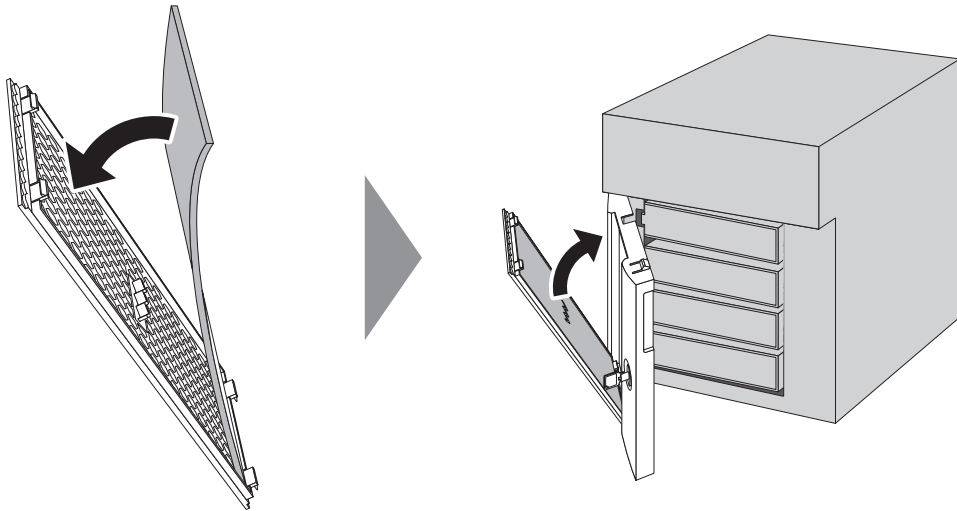

**5** Close the front cover.

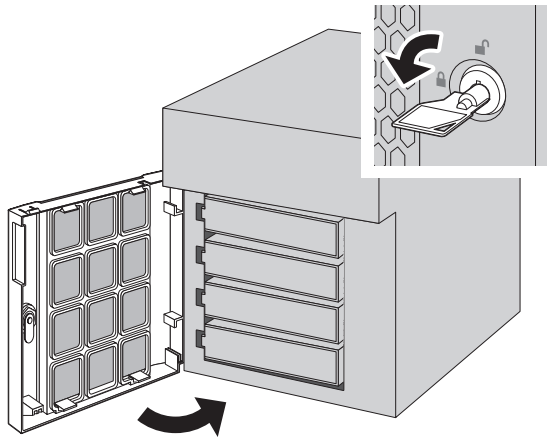

# Chapter 12 Utilities

---

## NAS Navigator2

---

NAS Navigator2 is a utility program that makes it easy to display Settings, change the Buffalo NAS device's IP address, or check its drives. To install NAS Navigator2, refer to the appropriate procedure below for your computer.

### Windows

---

The NAS Navigator2 installer for a Windows computer is available from the d.buffalo website, accessible from <https://d.buffalo.jp/TS5020/>.

Once you have accessed the URL, select the region and model to go to your specific model's d.buffalo website. Download the NAS Navigator2 installer and install the utility onto your computer.

Refer to the software help for more detailed information on operating the software. To open the help, launch NAS Navigator2 and navigate to *Menu > Help*.

### macOS

---

The NAS Navigator2 app for a macOS computer is available from Mac App Store. Download the app and install it. Refer to the software help for more detailed information on operating the software. To open the help, launch NAS Navigator2 and navigate to *Help > NAS Navigator2 Help* from the menu bar.

---

## NovaBACKUP

---

NovaBACKUP is a Windows utility that lets you back up data on your computer.

The NovaBACKUP installer is available from the d.buffalo website, accessible from <https://d.buffalo.jp/TS5020/>.

Once you have accessed the URL, select the region and model to go to your specific model's d.buffalo website.

Download the NovaBACKUP installer and install the utility onto your computer.

To download the installer, you will need the serial number of your TeraStation. The serial number is printed on the label on the back or the top of the unit. For the TS5420RN TeraStation model, the serial number can be found on the front as well. Refer to the "[Diagrams](#)" section in chapter 2 for information on where to find the serial number of your device.

# Chapter 13 Appendix

## LCD Panel

### Modes

The LCD panel can be cycled through different modes by pressing the display button.

LCD Message		Description	Corrective Action
LANx <b>Note:</b> The "x" indicates the number of the LAN port where the Ethernet cable is connected.	LANx Not Connected	Not connected to a network.	Connect an Ethernet cable to the LAN port.
	LANx Half Duplex 10 Mbps	Connected at 10 Mbps half duplex.	-
	LANx Full Duplex 10 Mbps	Connected at 10 Mbps full duplex.	-
	LANx Half Duplex 100 Mbps	Connected at 100 Mbps half duplex.	-
	LANx Full Duplex 100 Mbps	Connected at 100 Mbps full duplex.	-
	LANx 1000 Mbps	Connected at 1000 Mbps.	-
	LANx 2.5 Gbps	Connected at 2.5 Gbps.	-
	LANx 5 Gbps	Connected at 5 Gbps.	-
	LANx 10 Gbps	Connected at 10 Gbps.	-
	LANx Port Trunking	Displays if port trunking is configured.	-
Model Name/ Firmware Version	TS5420D FW Version 1.00	Displays the model name and firmware version. <b>Note:</b> This example is using the TS5420DN TeraStation model. The numbers and letters after "TS" may vary depending on your model.	-
Hostname	Hostname: TS5420Dxxx	Displays the hostname. <b>Note:</b> The "xxx" is assigned using the last three-digits of the MAC address.	-
Date and Time	Date Time YYYY/MM/DD hh:mm	Displays the date and time set on the TeraStation.	-

LCD Message		Description	Corrective Action
IP Address	LANx DHCP 192.168.11.150	Displays the IP address. If acquiring from a DHCP server automatically, "DHCP" will be displayed. If configuring a static IP address, "Static IP" will be displayed.	-
	LANx Port Trunking	Displays if port trunking is configured.	-

## Errors

If a critical error occurs, one of the following messages will appear on the LCD panel and the error LED will glow red. If there is a corresponding corrective action described below for the code, try it first. If the code is still displayed after trying the corrective action, contact Buffalo technical support for assistance.

You can also confirm the current status from the Dashboard in Settings or by using NAS Navigator2. If NAS Navigator2 displays the error as an unknown error, check the Dashboard in Settings for the error details.

**Note:** The "x" in the LCD message is the number of the drive or array involved in the process.

LCD Message	Description	Corrective Action
E10 UPS Running Off Battery	The TeraStation is running on the UPS battery due to a power outage.	Shut down the TeraStation safely and wait until the power outage ends. If certain settings are configured, the TeraStation may shut down automatically when the error is detected.
	If the setting to use the UPS connected to this TeraStation has been configured, the UPS cable may be disconnected.	Verify that the UPS cable or Ethernet cable is connected properly.
	If the setting to use the UPS connected to another TeraStation on the same network has been configured, the Ethernet cable of this TeraStation may be disconnected.	
E11 Fan Failure	An error occurred in the fan speed.	Check that no foreign objects or dust are clogging the fan. If any foreign objects or dust are found, use a pair of tweezers, an air duster, or other tools to remove them.
E12 Cooling Failure	A rise in the system temperature may have exceeded the allowable safety value.	Move the TeraStation to a cool location. Do not place objects in the area around the TeraStation.
E14 Can't Mount Array x	The RAID array cannot be mounted.	If the message appears after initial bootup, make sure drives are inserted properly by referring to the <a href="#">"Re-Inserting Drives"</a> section in chapter 11. For all other cases, run a drive check on the RAID array by referring to the <a href="#">"Checking Drives"</a> section in chapter 4.
E16 Drive x Not Found	Unable to find the drive.	Re-insert the drive by referring to the <a href="#">"Re-Inserting Drives"</a> section in chapter 11.
E22 Can't Mount Drive x	Unable to mount the drive.	Format the drive by referring to the <a href="#">"Formatting Drives"</a> section in chapter 4. After formatting, if the error still appears after rebooting, replace the drive.
E27 Lost Failover Target	Unable to find the failover backup TeraStation.	Reconfigure the failover backup TeraStation for failover by referring to the <a href="#">"Configuring Failover"</a> section in chapter 5.

LCD Message	Description	Corrective Action
E30 Replace Drive x	An error occurred, so the drive was removed from the RAID array.	Replace the drive. Refer to the appropriate drive replacement sections in chapter 11 that corresponds to your TeraStation model.
E32 Check Power Supply	Power supply error.	Make sure that the power cable is securely connected. If the error is still present, replace the failed PSU to a new OP-PU-10R2 unit.
E41 NVRAM Failure	The NVRAM inside the TeraStation failed.	Contact Buffalo technical support for assistance.
E42 Migration Canceled	The migration process has been canceled because an error occurred.	Refer to the <a href="#">NAS migration guide</a> for the detailed corrective actions.

## Notices

If a non-critical error occurs, one of the following messages will appear on the LCD panel and the info LED will glow amber. If there is a corresponding corrective action described below for the code, try it first. If the code is still displayed after trying the corrective action, contact Buffalo technical support for assistance.

You can also confirm the current status from the Dashboard in Settings or by using NAS Navigator2. If NAS Navigator2 displays the error as an unknown error, check the Dashboard in Settings for the error details. You can click the “Clear” button to delete messages from the Dashboard.

**Note:** The “x” in the LCD message is the number of the drive, array, or job involved in the process.

LCD Message	Description	Corrective Action
I10 System Is Overheating	A rise in the system temperature may have exceeded the allowable safety value.	Move the TeraStation to a cool location. Do not place objects in the area around the TeraStation.
I11 Bad Sectors on Drive x	The drive has too many bad sectors.	Replace the drive. Refer to the appropriate drive replacement sections in chapter 11 that corresponds to your TeraStation model.
I12 Degraded Mode	Operating in degraded mode.	Check if the E30 error is also displayed. If it is, refer to the corrective action for the E30 error.
I33 Replication Failure	An error occurred in replication, or synchronization between the main TeraStation and the backup TeraStation failed during failover configuration.	From Settings, navigate to <i>Backup &gt; Replication</i> and click <i>Resync</i> to execute resynchronization. If you configured the subfolders’ access restrictions to be inherited to the replication or failover destinations, disable them or change the destinations.
I44 Drive 1 Not Found	Initialization from the USB initialization drive was initiated, but the drive in slot 1 was not detected.	Make sure that the drive in slot 1 is present and fully inserted into its slot.
I45 Recovery Failure	Initialization failed.	-
I49 Lost Failover Main	The main TeraStation in the failover configuration cannot be found.	Make sure that the main TeraStation is on, working, and connected to the network.
I54 Backup Job x Failure	The backup job failed.	Refer to the <a href="#">“Backup Logs for If Backup Fails”</a> section in chapter 5 and try the respective corrective actions.

LCD Message	Description	Corrective Action
I55 Recovery Not Authorized	Authentication during initialization of settings failed.	Settings can only be restored for the TeraStation whose settings were originally saved.
I64 Cloud Sync Failure	Connecting to the cloud storage service failed.	Open Settings and check the status of the job that failed for the cloud service. Refer to the error log on the job list of the specific cloud storage service and check the cause of the error.
I66 Free Space at 1% or Less	The free space has decreased to 1% or less.	Increase the free space.
I70 No Space to Save Logs	There is not enough space to save file access logs.	Delete file access logs to free up space.
I72 Log Folder Now System Area	The target folder for saving logs has been changed to the system area.	Reconfigure the settings by referring to the <a href="#">“Changing Archive Rules for File Access Logs”</a> section in chapter 10.
I75 Some Items Not Migrated	Some items could not be migrated.	Refer to the <a href="#">NAS migration guide</a> for the detailed corrective actions.

## Information Events

After you change any settings, one of the following messages will appear on the LCD panel and the info LED will glow amber. If there is a corresponding corrective action described below for the code, try it first. If the code is still displayed after trying the corrective action, contact Buffalo technical support for assistance.

You can also confirm the current status from the Dashboard in Settings or by using NAS Navigator2. If NAS Navigator2 displays the status as an unknown error, check the Dashboard in Settings for the status details. You can click the “Clear” button to delete messages from the Dashboard.

**Note:** The “x” in the LCD message is the number of the drive, array, or job involved in the process.

LCD Message	Description	Corrective Action
I01 Rebuilding System Array	Checking the system area.	-
I13 Formatting Array x...	Formatting the RAID array.	-
I14 Checking Array x...	Checking the RAID array.	-
I15 Scanning Array x Data...	Examining the error status of the RAID array. <b>Note:</b> Transfer speeds are slower during the examination process.	-
I16 Creating Array x...	Creating the RAID array.	-
I17 Resyncing Array x...	Resynchronizing the RAID array. <b>Note:</b> Transfer speeds are slower during resynchronization.	-

LCD Message	Description	Corrective Action
I18 Rebuilding Array x...	Recovering the RAID array. <b>Note:</b> Transfer speeds are slower during the rebuilding process.	-
I19 Rewriting Array x...	Rewriting drives in the TeraStation with 0s.	-
I20 Formatting Drive x...	Formatting the drive.	-
I21 Checking Drive x...	Checking the drive.	-
I22 Rewriting Drive x...	Rewriting drives in the TeraStation with 0s.	-
I23 Initializing Settings...	The initialization process has been started by using the reset button and settings are being initialized.	-
I25 Updating Firmware...	Updating the TeraStation firmware.	Do not turn off the TeraStation's power.
I26 Initializing Settings...	The initialization process has been started by using Settings and all settings are being initialized.	-
I27 Checking USB Drive x...	Checking the USB drive.	-
I28 Formatting USB Drive x...	Formatting the USB drive.	-
I31 Push Func to Use New Drive x	Appears before the function button is pressed in order to use a newly-inserted drive.	Press the function button. If the RAID array enters degraded mode, the array will be rebuilt using the new drive. Otherwise, the new drive will be set as a hot spare. To use a drive as normal instead of a hot spare drive, refer to the appropriate "Drive Replacement for Hot Spare" section in chapter 11 that corresponds to your TeraStation model.
I32 New Drive x Detected	Appears after replacing the drive when the RAID array needs to be rebuilt in Settings or formatting is necessary.	From Settings, either recover the RAID array or format the drive.
I37 Recovering System...	The initialization process has been started by using the USB initialization drive and settings are being initialized.	-
I38 Recovery Finished	Settings initialization is finished.	-
I40 All Data Will Be Deleted	Beginning settings initialization. All data on the drive in slot 1 will be deleted.	-

LCD Message	Description	Corrective Action
I41 Push Func to Start Recovery	Press the function button to start the settings initialization process.	-
I42 Preparing Recovery	Preparing to start the settings initialization process.	-
I43 Unsupported Hardware	The TeraStation was started from the USB initialization drive, but the settings cannot be initialized from this USB initialization drive.	-
I46 Migrating RAID Array X...	Data migration or conversion (RAID migration) is in progress.	Do not turn off the TeraStation's power.
I47 Don't Power Off System!	Data migration or conversion (RAID migration) is in progress.	Do not turn off the TeraStation's power.
I48 Push Func to Start Failover	This TeraStation is ready to become the failover backup device for the main TeraStation.	Press and hold down the function button of the failover backup TeraStation until it stops beeping to accept failover backup status.
I50 Failover in Maintenance Mode	Failover maintenance is in progress.	Do not turn off the TeraStation's power.
I51 Initializing Failover...	Initializing the failover configuration.	Do not turn off the TeraStation's power.
I52 New Firmware Available	A new firmware version has been released.	Update the firmware by referring to the <a href="#">"Updating the Firmware"</a> section in chapter 10.
I61 Drive Setup Mode	The unit is in drive setup mode.	Recover from drive setup mode by referring to the <a href="#">"Power LED Keeps Blinking"</a> section in chapter 11.
I65 Free Space at Threshold	The free space has decreased past the configured threshold percentage.	Increase the free space or change the threshold to a lower value.
I71 Old Logs Removed	The space is occupied so older logs were removed.	Delete file access logs to free up space.
I73 Migration Processing...	Data or settings migration is in progress.	-
I74 Migration Finished	Data or settings migration has finished.	Refer to the <a href="#">NAS migration guide</a> for the detailed corrective actions.

## Default Settings

Administrator's Name	admin
Password	password
Shared Folders	"share" for both Windows and macOS computers. <b>Note:</b> The recycle bin is enabled by default.

IP Address	The TeraStation will get its IP address automatically from a DHCP server on the network. If no DHCP server is available, then an IP address will be assigned as follows: IP Address: 169.254.xxx.xxx ("xxx" is a number randomly assigned when booting the TeraStation.) Subnet Mask: 255.255.0.0	
Registered Groups	"hdusers", "admin", and "guest" You cannot edit or delete these default groups.	
Microsoft Network Group Settings	WORKGROUP	
MTU Size	1,500 bytes	
SMB	Enabled	
	Protocol Selection	Auto
	Recycle Bin Permissions	All users
	macOS Temp Files	Keep when original file is deleted
	Network Credentials	Log in as guest
	Enhanced Compatibility with macOS Clients	Disabled
FTP	Disabled	
SFTP	Disabled	
WebAccess	Disabled	
NFS	Disabled	
rsync	Disabled	
RAID Scanning	Disabled	
iSCSI	Disabled	
Amazon S3	Disabled	
Dropbox Sync	Disabled	
Microsoft Azure Storage Sync	Disabled	
Microsoft OneDrive Sync	Disabled	
SNMP	Disabled	
Replication	Disabled	
Time Machine	Disabled	
Name/Time/Language	NTP	Enabled
Email Notification	Disabled	
Initialize	Reset Button Settings	Restore admin username and password to factory defaults
RAID Mode	TS5420DN (partially-populated model): RAID 1 TS5420DN, TS5420RN: RAID 5 TS5820DN, TS51220RH: RAID 6	

## Specifications

Check the [Buffalo website](#) for the latest product information and specifications.

1GbE LAN Interface	Standards Compliance	IEEE 802.3ab (1000BASE-T), IEEE 802.3u (100BASE-TX), IEEE 802.3 (10BASE-T)
	Data Transfer Rates	10/100/1000 Mbps (auto sensing)
	Number of Ports	2

10GbE LAN Interface	Standard Compliance	IEEE 802.3an (10GBASE-T), IEEE 802.3bz (2.5GBASE-T, 5GBASE-T), IEEE 802.3ab (1000BASE-T), IEEE 802.3u (100BASE-TX)
	Data Transfer Rates	2.5/5/10 Gbps, 100/1000 Mbps (auto sensing)
	Number of Ports	TS51220RH: 2 Other models than TS51220RH: 1
Common Specs for LAN Interface	Connector Type	RJ-45 8-pin (auto MDI-X)
	Supported Protocols	TCP/IP
	Network File Services	SMB/CIFS, FTP/SFTP, NFS, HTTP/HTTPS, SNMP
	MTU Sizes	1,500–9,216 bytes
USB Interface	Standards Compliance	USB 3.2 Gen 1/USB 2.0
	Data Transfer Rates	USB 3.2 Gen 1: max. 5 Gbps USB 2.0: max. 480 Mbps
	Number of Ports	TS5420DN: 2 × USB 3.2 Gen 1 TS5420RN, TS5820DN: 3 × USB 3.2 Gen 1 TS51220RH: 2 × USB 3.2 Gen 1, 2 × USB 2.0
	Connector Type	Type A
Internal Drive	Number of Drive Bays	TS5420DN, TS5420RN: 4 TS5820DN: 8 TS51220RH: 12
	Drive Interface	SATA 6 Gbps
	Supported RAID	0, 1, 5, 6, 10, JBOD (individual drives)
	Replacement Drive	TS51220RH: Buffalo OP-HDH2U series drive Other models than TS51220RH: Buffalo OP-HDN series drive <b>Note:</b> The replacement drive should be the same capacity or larger as the original drive. The drives listed above are available from the <a href="#">Buffalo website</a> .

Others	Power Supply	TS5420DN, TS5420RN: AC 100–240 V, max. 2.5 A, 50/60 Hz TS5820DN: AC 100–240 V, max. 3.0 A, 50/60 Hz TS51220RH: AC 100–240 V, 7.0–3.5 A, 50/60 Hz
	Dimensions (W × H × D, excluding protruding parts)	TS5420DN: 170 × 215 × 230 mm (6.7 × 8.5 × 9.1 in.) TS5420RN: 430 × 44.3 × 430 mm (16.9 × 1.7 × 16.9 in.) TS5820DN: 300 × 215 × 230 mm (11.8 × 8.5 × 9.1 in.) TS51220RH: 481 × 88 × 736.9 mm (18.9 × 3.5 × 29.0 in.)
	Weight	TS5420DN: approx. 7.1 kg (15.1 lbs) TS5420DN (partially-populated model): approx. 5.6 kg (12.6 lbs) TS5420RN: approx. 8.5 kg (18.1 lbs) TS5820DN: approx. 12.2 kg (26.1 lbs) TS5820DN (partially-populated model): approx. 10.8 kg (23.1 lbs) TS51220RH: approx. 25.1 kg (55.5 lbs) TS51220RH (partially-populated model): approx. 18.6 kg (41 lbs)
	Maximum Power Consumption	TS5420DN, TS5420RN: 100 W TS5820DN: 150 W TS51220RH: 500 W
	Operating Environment	Temperature: 0–40°C (32–104°F) Humidity: 10–85% non-condensing
	Compatible Devices	Windows PCs, Apple silicon- and Intel-based Mac computers, and Google Chromebooks with wired or wireless Ethernet connection.
	Supported OS	Windows 11, 10 Windows Server 2022, 2019, 2016 macOS 13.0, 12.0, 11.1, 10.15 Chrome OS