

Plena Weekly Timer



Security Systems

en | Installation and User Instructions
| PLN-6TMW

BOSCH

Important safeguards

Prior to installing or operating this product, always read the Important Safety Instructions, which are available as a separate document (9922 141 7014x). These instructions are supplied together with all equipment that can be connected to the mains.

Thank you for choosing a Bosch Security Systems product.

Table of contents

Important safeguards	2
Table of contents	3
1. Introduction	5
1.1 Purpose	5
1.2 Digital document	5
1.3 Intended audience	5
1.4 Related documentation	5
1.5 Alerts	5
1.6 Signs	5
1.6.1 Note signs	5
1.6.2 Caution Warnings and Dangers signs	5
1.7 Conversion tables	6
2. System overview	7
2.1 Plena	7
3. Equipment	9
3.1 Introduction	9
3.2 Controls, connectors and indicators	11
3.2.1 Front panel	11
3.2.2 Display	12
3.2.3 Rear panel	13
3.3 Installation	14
3.4 External connections	14
3.4.1 Connect the back-up power supply	14
3.4.2 Connecting other Plena devices	15
3.4.3 Power	16
4. Switch on and off	17
4.1 Switch on	17
4.2 Switch off	17
5. Setting the date and time	19
5.1 Summer and Winter (daylight saving) time settings	19
6. Manual settings	21
6.1 Selecting a program	21
6.2 Activating an output contact	21
6.3 Temporarily pausing events	21
6.4 Setting BGM levels	21
6.5 Locking the buttons and rotary selector	21
7. Programming a schedule	23
7.1 Introduction	23
7.2 Programming an event	23
7.3 Viewing and editing events	26
8. Plena Weekly Timer Configuration software	27
8.1 Introduction	27
8.2 System requirements	27
8.3 Installing the software	27
8.4 Connecting to a PC	29
8.5 Starting the software	29

8.6	Main menu buttons	30
8.6.1	Setup	30
8.6.2	System settings	30
8.6.3	Schedule programming	30
8.6.4	Download schedule	30
8.6.5	Modify password	30
8.6.6	Save configuration file	30
8.6.7	Open configuration file	30
8.7	System settings	31
8.7.1	System setting	31
8.7.2	Time settings	31
8.8	Schedule programming	32
8.8.1	Schedule programming	33
8.8.2	Upload configuration	35
8.9	Download schedule	36
8.10	Modify password	37
8.11	Save configuration file	37
8.12	Open configuration file	38
9.	Technical data	39
9.1	Electrical	39
9.2	Performance	39
9.3	Audio inputs	39
9.4	Audio outputs	39
9.5	Mechanical	39
9.6	Interconnection	39
9.7	Environmental	39
9.8	Controls and indicators	39
9.9	Clock accuracy (without sync)	39
9.10	Power supply	39
9.11	Parts included	39

1 Introduction

1.1 Purpose

These Installation and User Instructions provide information on installing, configuring, and operating the Plena Weekly Timer.

1.2 Digital document

The Installation and User Instructions are also available as a digital document in the Adobe Portable Document Format (PDF). All references to pages, figures, tables, etc. in this digital document contain hyperlinks to the referenced locations.

1.3 Intended audience

These Installation and User Instructions are intended for installers and users of a Plena system.

1.4 Related documentation

The following related document is available: Plena Voice Alarm System Basic System Manual (9922 141 1036x).

1.5 Alerts

Four types of alerts are used in this manual. The alert type is closely related to the effect that may be caused if it is not observed. These alerts - from least severe effect to most severe effect - are:

- **Note**
Alert containing additional information. Usually, not observing a note alert does not result in damage to the equipment or personal injuries.
- **Caution**
The equipment can be damaged if the alert is not observed.
- **Warning**
Persons can be (severely) injured, or the equipment can be seriously damaged, if the alert is not observed.
- **Danger**
Not observing the alert can result in death.

1.6 Signs

1.6.1 Note signs

The signs used in combination with Notes provide extra information about the Note. See the following examples:

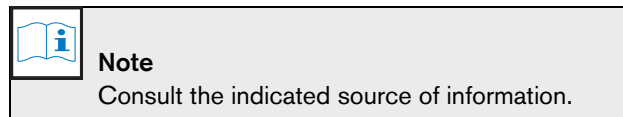
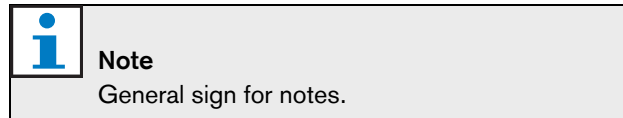

1.6.2 Caution Warnings and Dangers signs

The signs used in combination with Caution, Warnings, and Dangers indicate the type of hazard present. See the following examples:

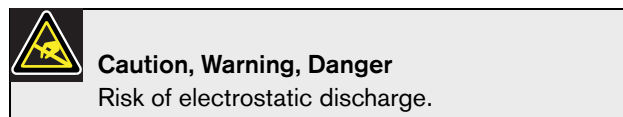
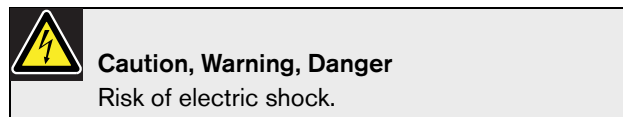
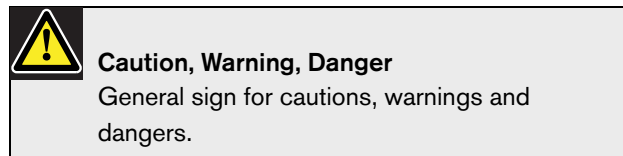

1.7 Conversion tables

In this manual, SI units are used to express lengths, masses, temperatures etc. These can be converted to non-metric units using the following information.

table 1.1: Conversion of units of length

1 in =	25.4 mm	1 mm =	0.03937 in
1 in =	2.54 cm	1 cm =	0.3937 in
1 ft =	0.3048 m	1 m =	3.281 ft
1 mi =	1.609 km	1 km =	0.622 mi

table 1.2: Conversion of units of mass

1 lb =	0.4536 kg	1 kg =	2,2046 lb
--------	-----------	--------	-----------

table 1.3: Conversion of units of pressure

1 psi =	68.95 hPa	1 hPa =	0.0145 psi
---------	-----------	---------	------------



Note

1 hPa = 1 mbar.

$$^{\circ}F = \frac{9}{5} \cdot ^{\circ}C + 32$$

$$^{\circ}C = \frac{5}{9} \cdot (^{\circ}F - 32)$$

2 System overview

2.1 Plena

The Plena Weekly Timer is part of the Plena product range. Plena provides public address solutions for places where people gather to work, worship, trade, or to relax. It is a family of system elements that are combined to create public address systems tailored for virtually any application.

The range includes:

- mixers
- preamplifiers
- power amplifiers
- a music source unit
- a digital message manager
- a feedback suppressor
- call stations
- an 'All-in-One' system
- a voice alarm system
- a timer
- a charger

The various elements are designed to complement each other thanks to matched acoustical, electrical and mechanical specifications.

Intentionally left blank.

3 Equipment

3.1 Introduction

The Plena Weekly Timer (which is perfectly suited for connecting to the Plena Message Manager and Voice Alarm System) is an accurate timer for use in public address systems. It is ideal for schools, shopping malls and all other venues, where regularly timed messages, signals or other controls (such as the automatic locking and unlocking of doors) are required.

The Timer can be programmed from:

- the controls on the front panel.
- a PC which has the Plena Weekly Timer Configuration software installed.

If the Timer is programmed using the configuration software, a USB cable is required to connect the PC to the Timer.

The Timer has two weekly schedules that can be individually programmed. Each day of the week has a separate event set, which means that two separate schedules can be programmed for any one day. Events can be programmed to an accuracy of one minute, and there is no limit to the number of events.

See figure 3.1 (on the next page) for a schematic overview of the Plena Weekly Timer.

Any single event can consist of:

- one of 14 pre-programmed chimes (which are broadcast via the audio throughput).
- adjusting (or switching off) of the Back Ground Music (BGM) - attenuation.
- any combination of output contacts that have internal relays for connecting to numerous types of equipment. There are 6 output contacts in total.

The output contacts can be set to: open, close, or generate a pulse.

Pulse duration can be globally programmed, and chimes shorter than one minute can be set to repeat a number of times in the general system settings.

However, these options are only available if the Plena Weekly Timer Configuration software is being used.

The intuitive front panel allows users to easily switch between the two programmable schedules. The programmable output contacts can also be manually activated, allowing for random events to take place; for example, if a door lock has to be suddenly opened (before the scheduled time), the user can push one of the 6 output contact buttons on the front panel of the unit. The Timer will re-lock the door as programmed during the next applicable event.

A pause button also allows users to temporarily suspend all events, with the exception of the clock display, while pressing and holding the rotary selector allows the user to lock all controls of the front panel. This safety feature prevents unscheduled events from being accidentally activated.

The Timer has an audio input and output (cinch and XLR) for attenuating BGM signals (see figure 3.1). The volume can be directly controlled from the front panel, or programmed to lower at set times. The Timer will then automatically select the programmed volume at the start of the next event.

This allows users to automatically adjust the background music to suit the time of day; for example, music can be automatically attenuated in the morning or evening hours, or BGM can only be allowed at certain times of the day.

The Timer has a clock sync. input for synchronizing the time with an external source; the correct time can also be downloaded from a PC. This allows the Timer to be synchronized with a time server. The Timer clock also keeps track of the date, ensuring for the correct display of weekdays, and automatic Summer/ Winter time (daylight saving time) settings (according to European, North American, user defined dates).

The Timer has a 24V backup power input with reverse-polarity protection, as well as a backup battery that preserves the correct clock setting. Synchronization is done via the USB port. There is an RS-232 connector on the back panel for connecting the Timer to a large separate display.

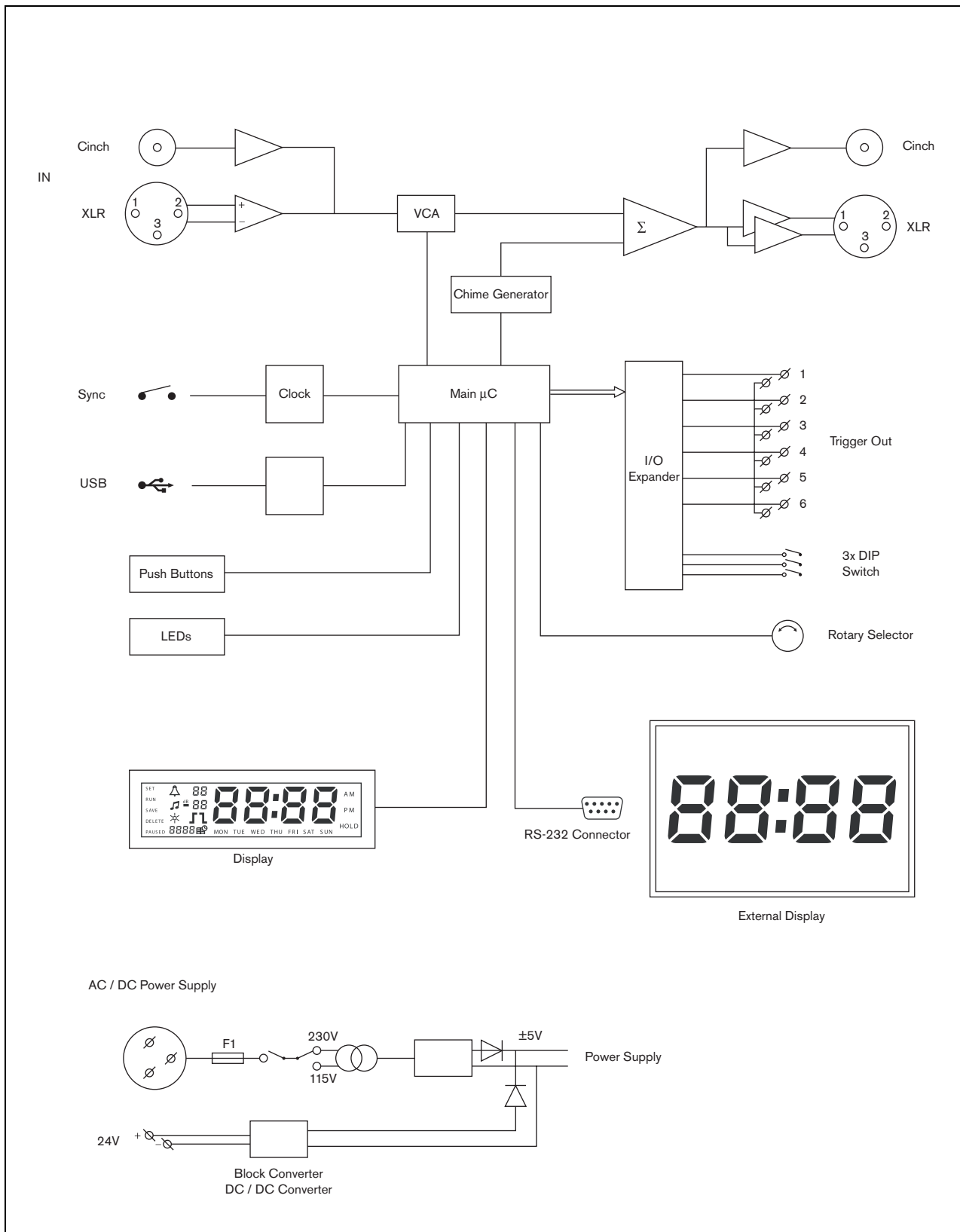

figure 3.1: Schematic overview of the Plena Weekly Timer

3.2 Controls, connectors and indicators

3.2.1 Front panel

See figure 3.2 for an overview of the controls and indicators.

- 1 **Program buttons, and indicator LEDs**
1 through 2
- 2 **Output contact buttons, and indicator LEDs**
1 through 6
- 3 **Save settings button** - saves date and time set-up; saves programmed events
- 4 **Set button** - starts date and time set-up sequence; starts and stops programming sequence
- 5 **Pause button** - temporarily suspends events, and deletes events when in the programming mode
- 6 **Main display** - shows time, and program settings
- 7 **Reset button** - for resetting the software of the Timer (use a pin to activate the small button)
- 8 **Rotary selector** - for selecting and confirming settings

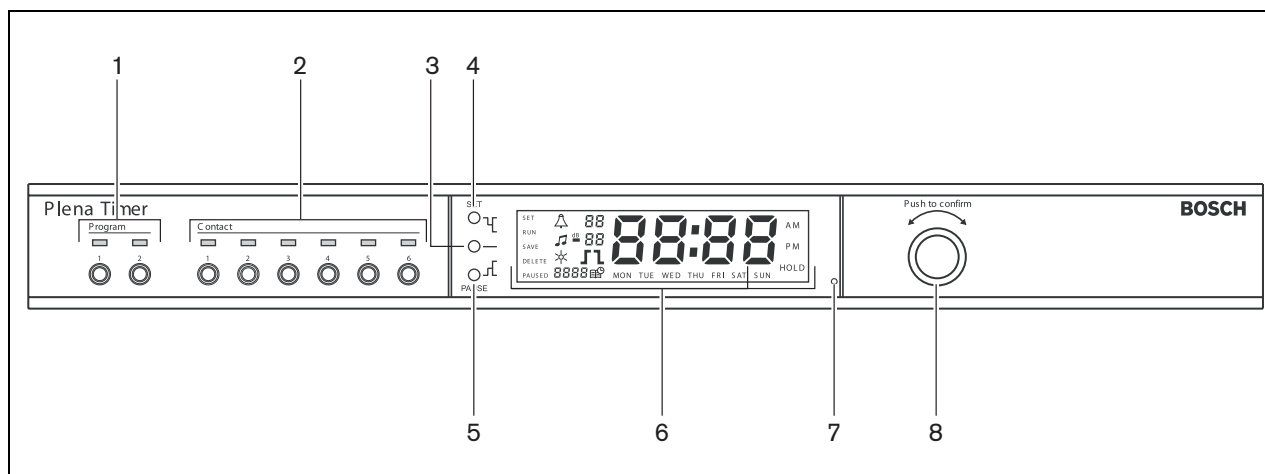

figure 3.2: Front panel

3.2.2 Display

See figure 3.3 for an overview of the main display.

- 1 **PAUSED** - indicates that all events are temporarily suspended (see section 6.3)
- 2 **DELETE** - indicates that the displayed event can be deleted (see section 7.3)
- 3 **SAVE** - indicates that the date and time set-up (see section 5), and programmed events (see section 7) can be saved
- 4 **RUN** - indicates that the Timer is running
- 5 **SET** - indicates that Set can be pressed at any time to leave the programming sequence without changing the settings
- 6 **Sun symbol** - indicates that Summer time (daylight saving time) is selected (see section 5.1)
- 7 **Chime symbol** - showing the status of the chime
- 8 **BackGround music symbol** - with “-dB” setting
- 9 **Chime volume**
- 10 **BackGround music volume**
- 11 **Time** - in hours and minutes
- 12 **Event number/ year**
- 13 **Event symbol**
- 14 **Trigger type** - used for output contacts (see table 7.2)
- 15 **Day of the week**
- 16 **Hold** - indicates that all controls on the front panel are locked (see section 6.5)

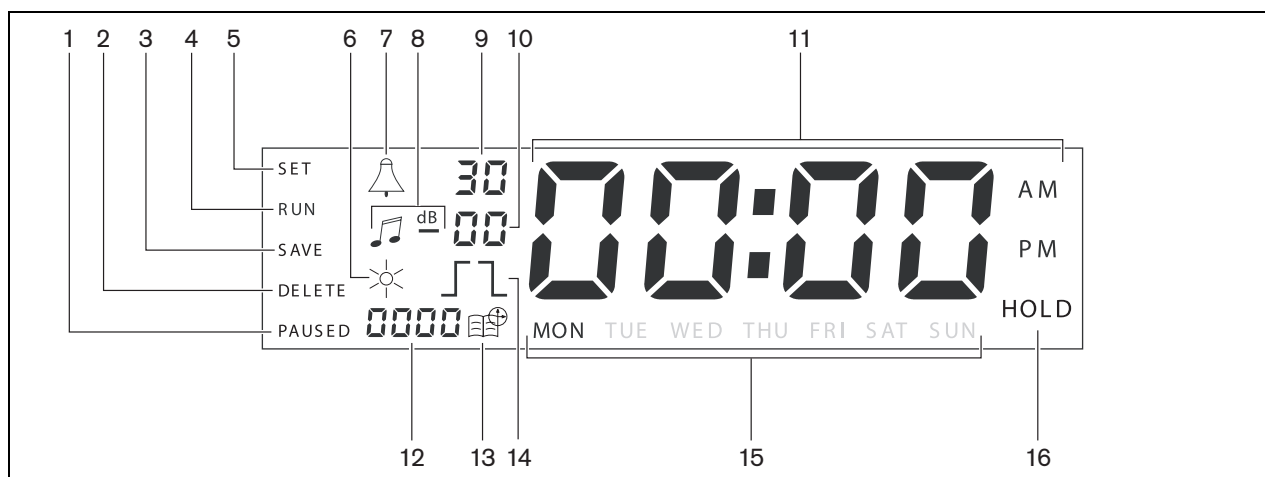

figure 3.3: Main display

3.2.3 Rear panel

See figure 3.4 for an overview of the connectors and switches:

- 1 **Audio loop through** - Cinch input
- 2 **Audio loop through** - Cinch output
- 3 **Audio loop through** - XLR input (female)
- 4 **Audio loop through** - XLR output (male)
- 5 **Trigger outputs** (1 through 6)
- 6 **Sync input** - for synchronizing the Timer with an external source
- 7 **24V DC in** - for backup power supply
- 8 **Type plate** - including 12nc number, and serial number
- 9 **DIP-switches (3pcs)** - for Summer/Winter time (daylight saving time) and service setup
- 10 **RS-232 connector** - for connecting external PC
- 11 **USB connector** - for connecting external PC
- 12 **Earth connection screw**
- 13 **Voltage selector** (115V/ 230V)
- 14 **ON - OFF switch**
- 15 **Mains connector** (3-pole)

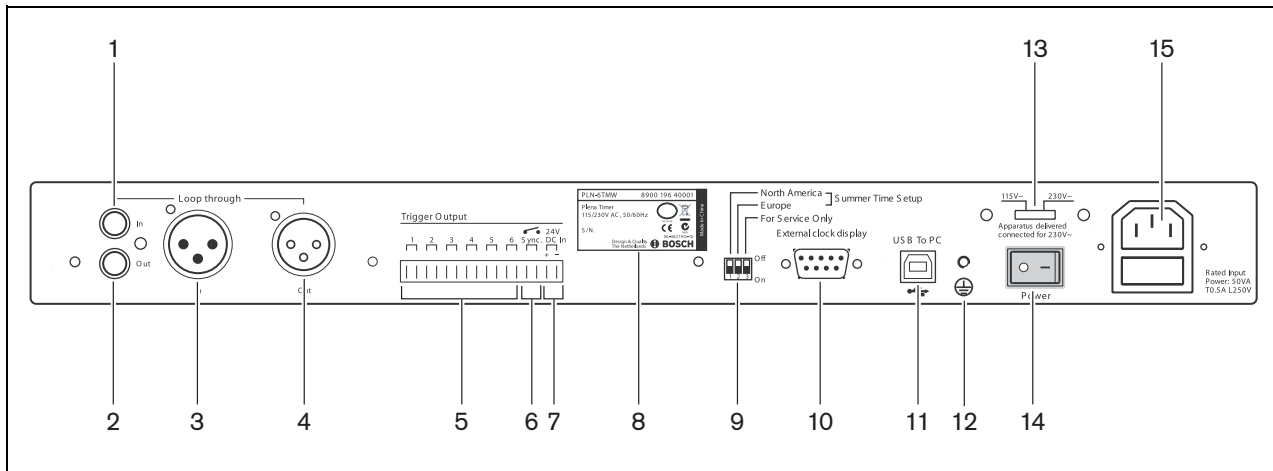

figure 3.4: Rear panel

3.3 Installation

The Timer can be installed on a table-top or in a 19-inch rack. Two rack-mounting brackets are supplied (see figure 3.5 for installation details).

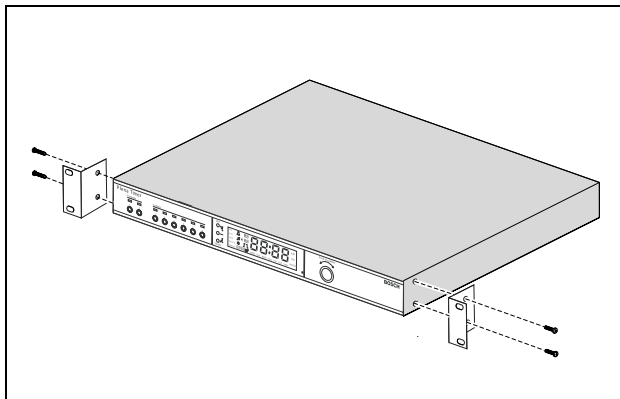

figure 3.5: Brackets for rack-mounting

3.4 External connections

3.4.1 Connect the back-up power supply

The Timer has two 24 Vdc screw terminals (7) for connecting a backup power supply. You must connect an earth (12) to the unit to increase the electrical stability of the system.

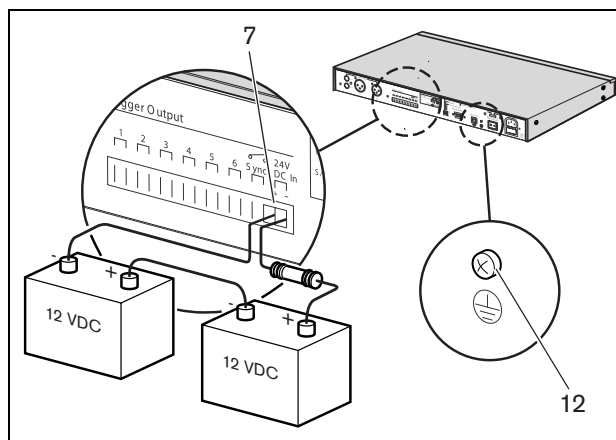

figure 3.6: Back-up battery connections

3.4.2 Connecting other Plena devices

The following inputs and outputs can be used to connect the Timer to other Plena devices (see figure 3.7):

- Audio loop through - Cinch input
- Audio loop through - Cinch output
- Audio loop through - XLR input (female)
- Audio loop through - XLR output (male)

The cinch input and XLR input, as well as the cinch output and XLR output are connected in parallel (see figure 3.1).

This means that the Timer can be connected to other Plena devices, using any combination of audio loop through inputs and outputs.

For example, the “PLN-DVDT cinch out” can be connected to the “Timer cinch in”, and the “Timer XLR out” can be connected to the “Mixer Amplifier XLR in” (preferred set-up). The “Timer cinch out” can also be connected to the “Mixer Amplifier cinch in”.

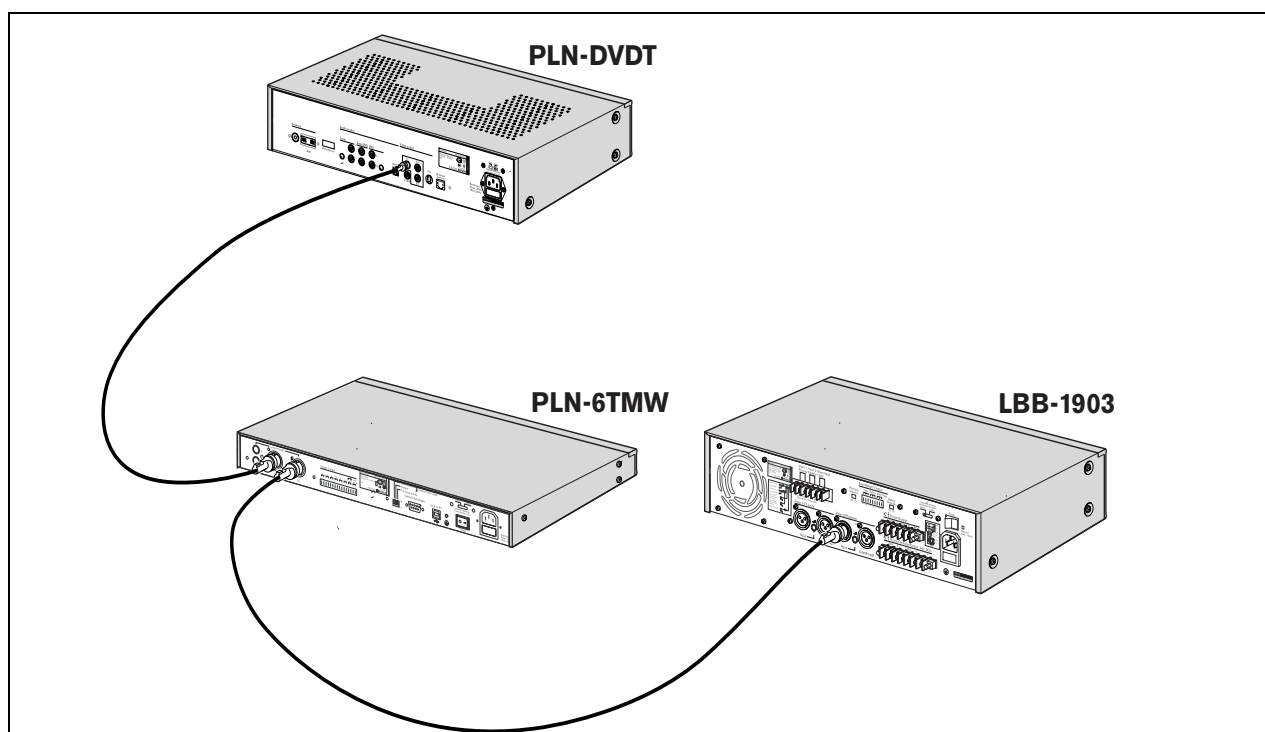

figure 3.7: Connecting other Plena devices

3.4.3 Power

- 1 Make sure the power switch (14) on the rear of the Timer is set to the “O” position (see figure 3.8).



Caution

Potential equipment damage. Before connecting the mains lead, always check the voltage selector on the rear panel of the Timer.

- 2 Make sure the voltage selector (115V/ 230V) (13) is correctly set for the country's main voltage (see figure 3.8).
- 3 Use the mains lead to connect the Timer to the power supply (see figure 3.8).

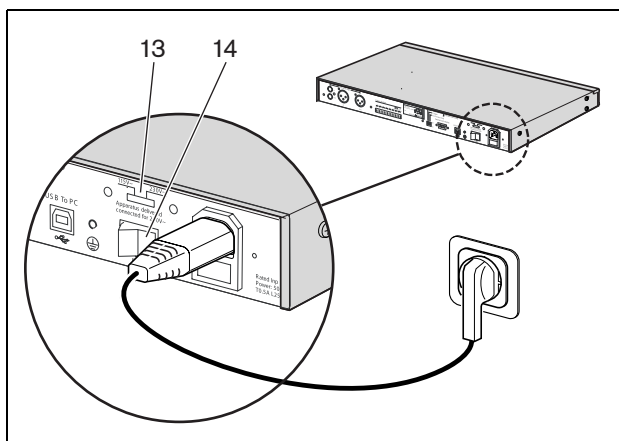

figure 3.8: Mains lead

4 Switch on and off

4.1 Switch on



Caution

Potential equipment damage. Before applying power, always check the voltage selector on the rear panel of the Timer.

- 1 Make sure the voltage selector (115V/ 230V) (13) is correctly set for the country's main voltage (see figure 4.1).
- 2 Set the power switch (14) on the rear of the Timer to the "I" position.

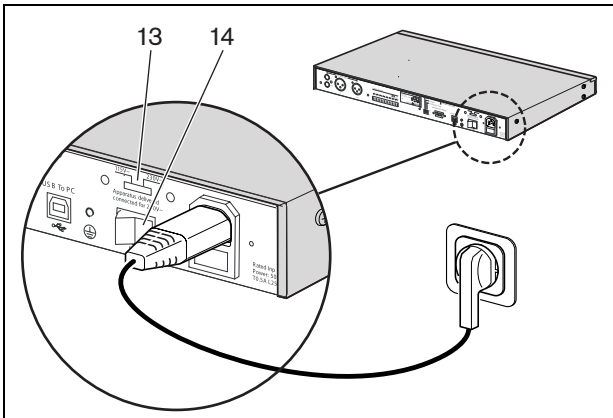

figure 4.1: Power switch on rear panel

If mains power (or back-up power) is available, the Program LEDs (1) and Contact LEDs (2) on the front of the Timer will be momentarily lit during initial system power up, and the main display will come on (see figure 4.2).

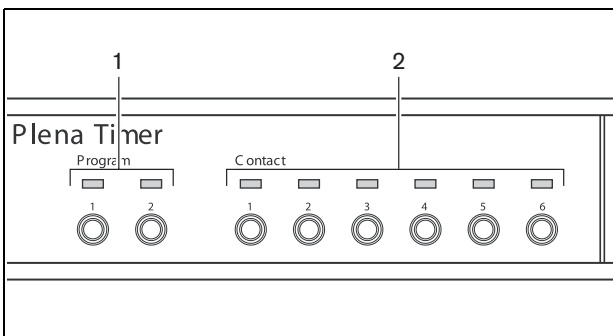

figure 4.2: Front panel LEDs

4.2 Switch off

Set the power switch (14) on the rear of the Timer to the "O" position (see figure 4.1).

Intentionally left blank.

5 Setting the date and time



Note

You can also use the Plena Weekly Timer Configuration software to set the date and time. For more information, see section 8.

Before using the Timer, you should make sure that the date and time are correctly set. If necessary, adjust the date and time as follows:

- 1 Make sure the Timer is switched on (see section 4).
- 2 Press and hold in the Set button until the year starts to flash (see figure 5.1).
- 3 Turn the rotary selector to select the year, and then push the rotary selector to confirm the setting. The month number will start to flash.



figure 5.1: Starting the date and time set-up sequence

Using the same method as described in step 3:

- 4 Select the month and confirm. The day number will start to flash.
- 5 Select the day and confirm. The hours (12) will start to flash.
- 6 Select between 12 and 24 hour clock settings and confirm. The hours will start to flash.
- 7 Select the hour and confirm. The minutes will start to flash.
- 8 Select the minutes and confirm. The date and time set-up is now complete.
- 9 Press the Save button to save your settings. The normal run screen will be displayed.



Note

To modify the date and time, just press and hold in the Set button. Then repeatedly press the rotary selector to quickly jump to, and change, the settings.

5.1 Summer and Winter (daylight saving) time settings

The clock can be set for European or North American Summer/Winter time (daylight saving time). To do this:

- 1 Locate the set of DIP switches on the rear panel (see figure 5.2).

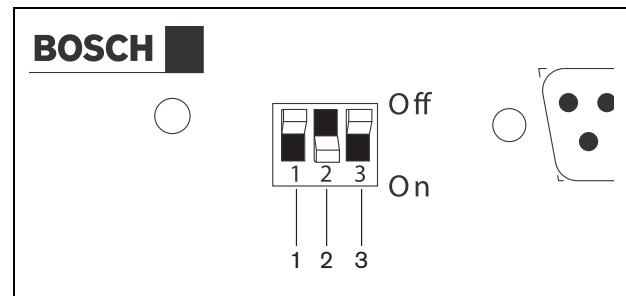

figure 5.2: Configuring Summer/Winter time (daylight saving time)

- 2 Set the DIP switches according to table 5.1.

table 5.1 DIP switch settings for Summer/Winter time (daylight saving time)

Status	Switch 1	Switch 2	Switch 3
European Summer/Winter time	Off	On	* Off
North American Summer/Winter time	On	Off	* Off
No Summer/Winter time selected	Off	Off	* Off
Summer/Winter time defined by configuration software	On	On	* Off



Note

Switch 3 is for service only, and should normally be left in the Off (up) position.

If no Summer/ Winter time (daylight saving time) is selected (option 3 in the above table), you can use the Program buttons on the front panel (see figure 3.2) to manually switch between Summer and Winter time. To do this:

- Press and hold in Program button 1 to switch to Summer time (daylight saving time). A small symbol of the sun will be displayed.
- Press and hold in Program button 2 to switch back to Winter time. The small symbol of the sun will disappear.

6 Manual settings

You can use the controls on the front panel to manually override programmed events. The Timer will automatically return to the programmed schedule at the start of the next event.

6.1 Selecting a program

The Timer has two weekly schedules that can be individually programmed (for more information on programming, see section 7 and 8).

Press the Program buttons 1 or 2 on the front panel to switch between the two programs. When the program is selected, the program LED will come on (see figure 6.1).

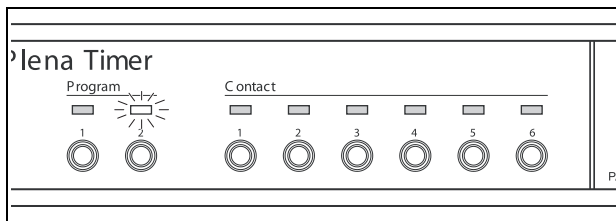

figure 6.1: Selecting a program

6.2 Activating an output contact

The Timer has 6 programmable output contacts for activating numerous types of equipment (for more information on programming, see section 7 and 8).

Press one of the Contact buttons (1 through 6) on the front panel to manually activate an output contact. When the output is activated, the Contact LED will come on (see figure 6.2).

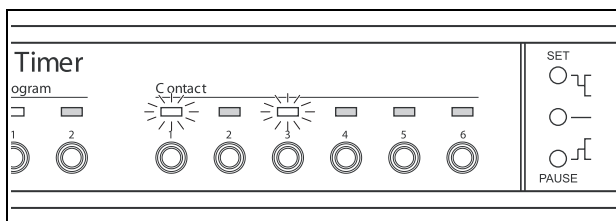

figure 6.2: Manually activating an output contact

6.3 Temporarily pausing events

Press the Pause button on the front panel to temporarily suspended all events. The word “Paused” will appear in the display next to the button.



Note

All events will be suspended until the Pause button is pressed again, and the word “Paused” is no longer displayed.

6.4 Setting BGM levels

Turn the rotary selector to manually set the BGM levels. The Timer will then automatically select the programmed volume at the start of the next event.

6.5 Locking the buttons and rotary selector

Press and hold in the rotary selector for a number of seconds to lock all controls of the front panel. This is useful if you do not want other users to accidentally trigger random events.

The word “Hold” will appear in the bottom right-hand corner of the display (see figure 6.3).



figure 6.3: Locking the controls of the front panel



Note

All controls will remain locked until the rotary selector is pressed and held in again for a number of seconds, and the word “Hold” is no longer displayed.

Intentionally left blank.

7 Programming a schedule

7.1 Introduction

This section describes how to use the controls on the front of the Timer to program a schedule. The Timer can also be programmed from a PC, using the Plena Weekly Timer Configuration software (see section 8).

For a clear overview of the programmable schedule, first see figure 8.14 in section 8.8.1. This figure shows the Schedule programming window, which can be used to program the Timer from a PC, using the Plena Weekly Timer Configuration software.

The advantages of using the Plena Weekly Timer Configuration software are:

- data can be quickly and easily entered.
- the user has a clear overview of the programmed events.
- schedules can be created remotely, and by numerous users.
- the schedule can be saved as a software file, and printed out if required.



Note

If a PC is used to program the Timer, you must disconnect the USB cable before using the Timer. If you do not disconnect the USB cable, the performance of the Timer might be affected.

7.2 Programming an event

- 1 Make sure the Timer is switched on (see section 4).
- 2 Momentarily press and release the Set button. The Program LEDs on the front panel will be alternately lit (see figure 7.1).

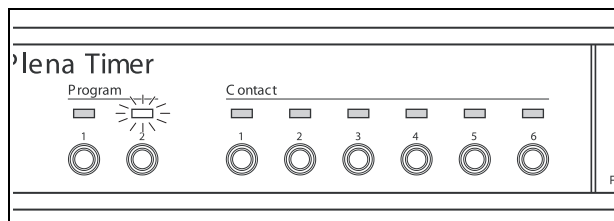

figure 7.1: Selecting a program

- 3 Press and hold in the Program button for the program you want to edit. The selected Program LED will remain lit.



Note

If you selected the wrong program to edit, you can press the Program button (1 or 2) to switch between the two programs. The selected program for editing will be displayed on the main display, and the relevant LED will be lit.

- 4 Press and hold in the rotary selector to start the programming sequence. The full display will reappear, and the day of the week will start to flash (see figure 7.2).



Note

If you want to leave the programming sequence at any time without changing the settings, press the Set button.



figure 7.2: Programming the day and time of the event

- 5 Turn the rotary selector to select the day that you want to program, and then push the rotary selector to confirm the setting. The hours will start to flash.

Using the same method as described in step 5:

- 6 Select the hour and confirm. The minutes will start to flash.
- 7 Select the minutes and confirm. The event symbol will start to flash, and the next available event number will be displayed (see figure 7.3).



Note

If at this point you only want to edit or view previously programmed events, see section 7.3 instead. Once you have pushed the rotary selector, you will have to continue programming the new event. See next step.

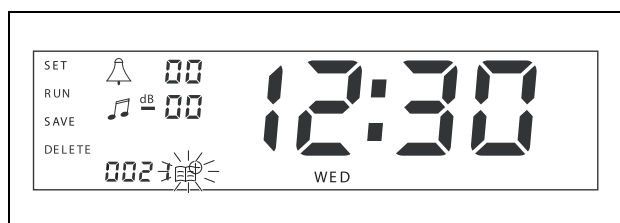

figure 7.3: Event symbol with new number displayed

- 8 Push the rotary selector to confirm the new event number. The number will then be assigned to the new event, and the chime symbol will start to flash.
- 9 Select a chime type between 1 and 14, and confirm (see table 7.1 for an overview of the chime types). The chime dB symbol will start to flash.

table 7.1: Overview of programmed Timer chimes

No.	Timer chime types
1	1.2 kHz (1 s)
2	554 Hz (2 s)
3	440 Hz (4 s)
4	554 Hz (1 s)
5	554 Hz (1 s), 440 Hz (1 s)
6	392 Hz (1 s), 523 Hz (1 s), 659 Hz (2 s)
7	554 Hz (1 s), 440 Hz (1 s), 493 Hz (1 s), 330 Hz (2 s)
8	659 Hz (1 s), 523 Hz (1 s), 392 Hz (1 s), 330 Hz (2 s)

table 7.1 (continued)

No.	Timer chime types
9	Evacuation 554 Hz (100 ms), 440 Hz (400 ms)
10	Immediate danger- 600 Hz (200 ms), pause (200 ms)
11	Fire alarm 440 Hz (12 s on, 12 s off)
12	Two-tone alarm 440 Hz (1 s), 554 Hz (1 s)
13	650 Hz 1.8 s on, 1.8 s off Swedish standard tone
14	Westminster chimes



Note

All dB settings for the chimes and BGM are minus settings, because the Timer can only attenuate (lower) any set signal; the timer cannot amplify signals.

- 10 Set a dB level between 0 and -30 for the chime and confirm. The BackGround Music dB symbol will start to flash.
- 11 Set a dB level between 0 and -30 for the BGM and confirm. The output contact trigger symbol will start to flash.







Note

The Plena Weekly Timer has six output contacts (see figure 3.4). Each output has four trigger settings (see table 7.2).

- 12 Push the Contact buttons (1 through 6) to select the required output. Once selected, the LED for the output contact will be lit.
- 13 Turn the rotary selector to select the type of trigger setting (see table 7.2), and then push the rotary selector to confirm the setting.
- 14 Press the Save button to save the programmed event. After a few seconds the full display will re-appear and the word RUN will be displayed in the top left-hand corner. This indicates that programming of the event is complete, and that the Timer is running.
- 15 To program the next event, repeat from step 2.

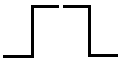
table 7.2: Output contact trigger settings

Trigger settings	Status of event	Status of switch	Example
	An event is switched on, and stays on until switched off.	Closed	A light is switched on
	An event is switched off.	Open	After a while, the same light is switched off
	An event is switched on, and then immediately switched off (pulsed).	Closed, and then immediately open	A message is started
	No event selected. The — symbol is only used for the Plena Weekly Timer Configuration software. If you do not want to select an event using the display, turn the rotary selector until no symbol is displayed.	Open	Nothing happens

**Note**

The output contacts are Normally Open (NO) contacts.

**Note**

When an event is started, the software will set the output contacts according to the settings of that current event (and will ignore the settings of any previous events). For example, if an output contact that was already open is set to open, nothing will happen.

7.3 Viewing and editing events



Note

Once you have pressed the rotary selector to either “confirm a new event” or “edit an existing one”, you will have to continue programming that event. You cannot return to previous events in any one programming session.

To view or edit an event, first follow steps 1 through 7 of section 7.2. When the event symbol starts to flash, you can either:

- turn the rotary selector to select other previously programmed events, and then press the rotary selector to continue editing that event as further described in section 7.2.
- press the Pause button to delete the entry. After a few seconds the full display will re-appear and the word RUN will be displayed in the top left-hand corner. This indicates that editing of the event is complete, and that the Timer is running.
- press the rotary selector to confirm the new event as described in step 8 of section 7.2.

8 Plena Weekly Timer Configuration software

8.1 Introduction

This chapter describes how to:

- install the Plena Weekly Timer Configuration software (version: 1.0012).
- connect a PC to the Timer.
- program events, using the PC.
- upload schedules from the PC to the Timer.
- download schedules from the Timer to the PC.

8.2 System requirements

The configuration software can be installed on any PC running Microsoft Windows 2000 or Microsoft Windows XP operating systems. Before installing the software make sure:

- the PC is working correctly, and is free of viruses.
- all other programs have been closed.

8.3 Installing the software

Proceed as follows:

- 1 Put the Plena CD-ROM in the CD-ROM drive of the PC. The CD-ROM starts automatically and a window similar to the one in figure 8.1 will appear. If the CD-ROM does not start automatically:
 - Go to Start > Run.
 - Enter X:\index.html. (Replace X with the character of the CD-ROM drive).

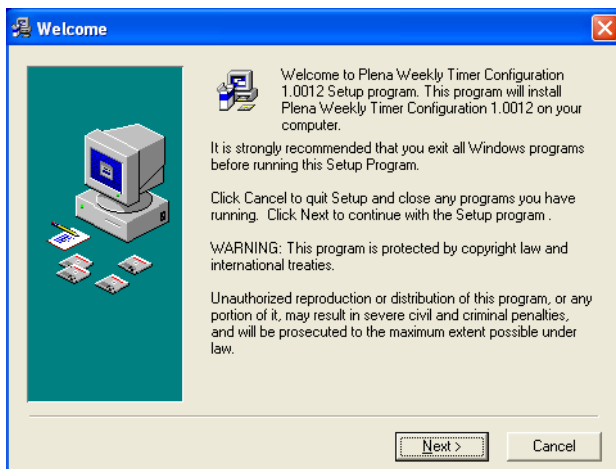

figure 8.1: Welcome

- 2 Follow the instructions on the window, and then click [Next]. A window similar to the one in figure 8.2 will appear.

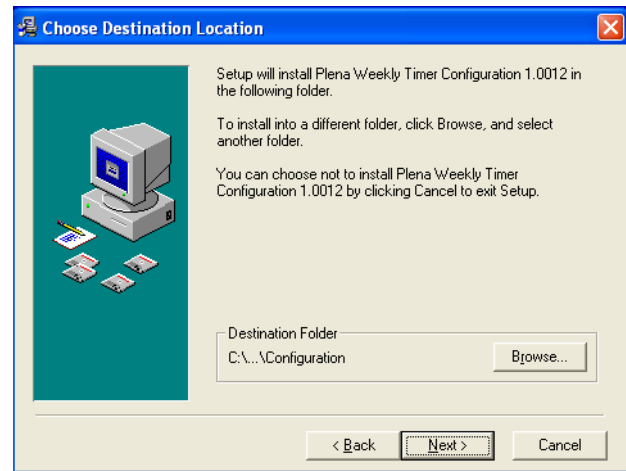

figure 8.2: Choose destination location

- 3 Choose the Destination Location Folder, and then click [Next]. A window similar to the one in figure 8.3 will appear.

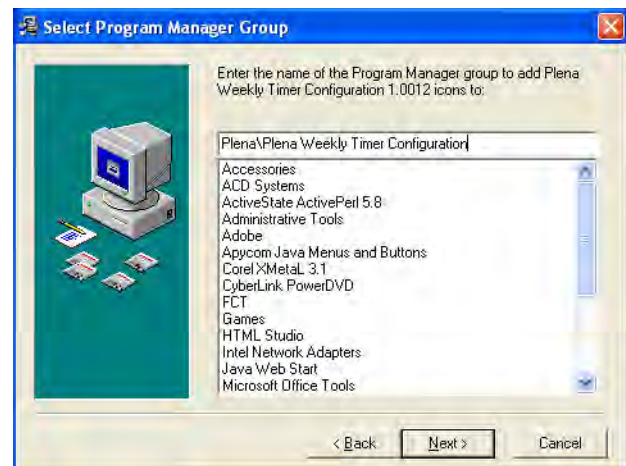

figure 8.3: Select program manager group

- 4 Select the Program Manager Group, and then click [Next]. A window similar to the one in figure 8.4 will appear.

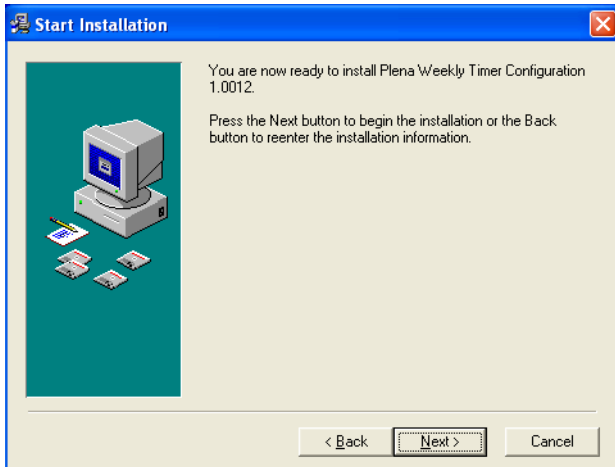

figure 8.4: Start installation

- 5 Follow the instructions on the window, and then click [Next]. The software will start to install (see figure 8.5).

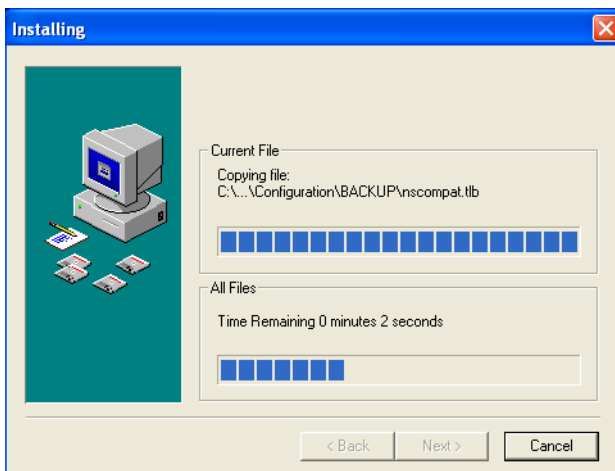

figure 8.5: Installing the software

- 6 Wait until the installation is complete. A window similar to the one in figure 8.6 will appear.

- 7 Click [Finish] to complete the installation process. The software is now ready to use.

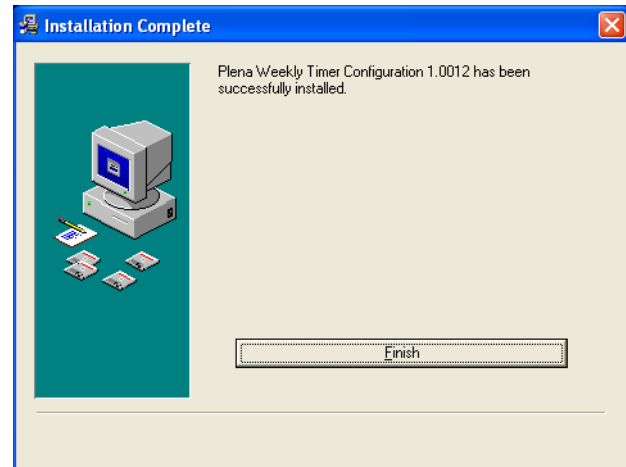

figure 8.6: Installation complete

8.4 Connecting to a PC

The supplied USB cable can be used to connect a PC to the Plena Weekly Timer (see figure 8.7). It is not necessary to switch the Timer off.



Note

The configuration software can be also used when the PC is not connected to the Timer, for example, to program a new schedule at home.

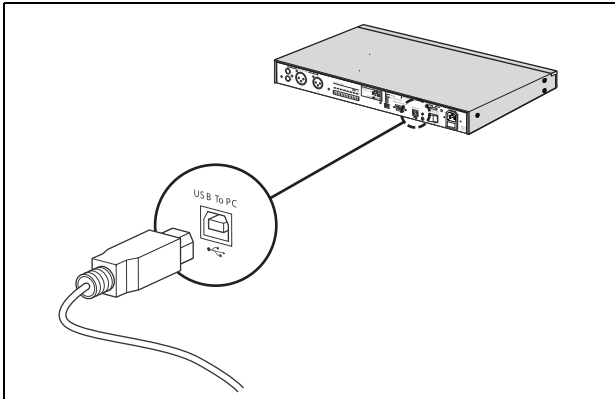

figure 8.7: Connecting a PC to the Timer



Note

Make sure you disconnect the USB cable from the Timer after uploading or downloading data. If you do not disconnect the USB cable, the performance of the Timer might be affected.

8.5 Starting the software

Proceed as follows:

- 1 Go to the desktop of Windows (see figure 8.8 for an example).



figure 8.8: Windows desktop

- 2 Double-click the Plena Weekly Timer Configuration icon. A window similar to the one in figure 8.9 will appear.

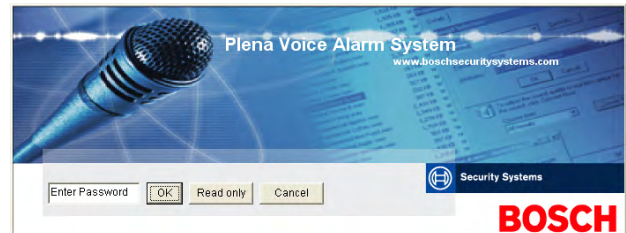

figure 8.9: Password

- 3 Enter the password (12345678) in the Enter password field, and click the OK button. The main menu will appear (see figure 8.10).



Note

The default password 12345678 can be changed in the configuration software (see section 8.6.5).

8.6 Main menu buttons

After entering the correct password, the Main menu will appear (see figure 8.10). Use the blue buttons on the left of this window to access all windows of the configuration software.

The various functions of the main menu are described in full detail on the following pages (for more detailed information, see section 8.7 through section 8.12).

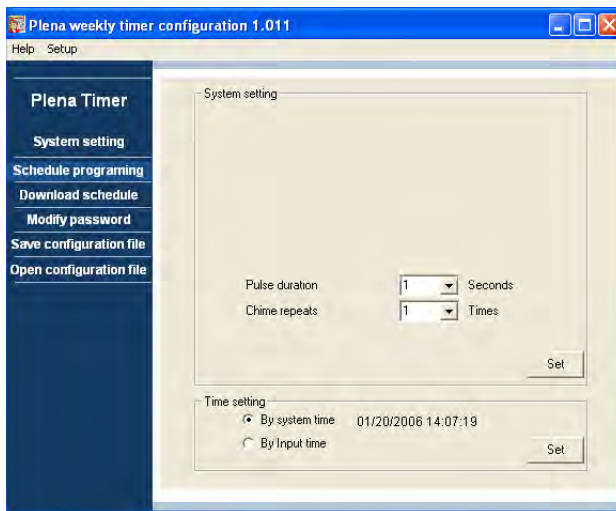

figure 8.10: Main menu

8.6.1 Setup

Select Setup, and then Language to set the required language (see figure 8.11).

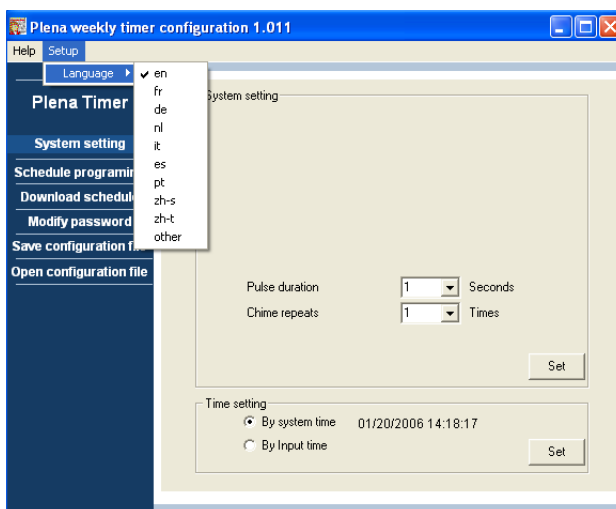

figure 8.11: Language setup option

8.6.2 System settings

Use the System settings window to enter the global system settings, and time settings (see section 8.7).

8.6.3 Schedule programming

Use the Schedule programming button to:

- Edit the programming for schedule 1 or 2.
- Upload the edited schedule to the Plena Weekly Timer.

8.6.4 Download schedule

Use the Download schedule button to download schedules from the Timer to the PC.

8.6.5 Modify password

Use the Modify password button to modify the password for accessing the software.

8.6.6 Save configuration file

Use the Save configuration file button to save the current configuration file.

8.6.7 Open configuration file

Use the Open configuration file button to open an existing configuration file.

8.7 System settings

Use this window to enter:

- the global system settings.
- the global time settings.



Note

The global system settings in this window influence all other general settings of the Timer (also see section 8.8.1). For example, if “Chime repeat” is set to 2, all chimes will be repeated twice for any one event.

From the main menu, click the System settings button. The following window will appear (see figure 8.12).

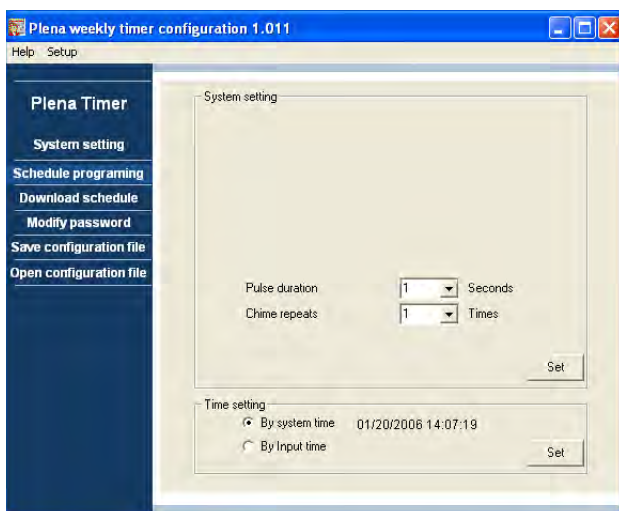

figure 8.12: System settings window

8.7.1 System setting

- 1 Click the pull-down arrow for Pulse duration, and select the number of seconds that all pulsed events should last (select a value between 1 and 50). These are all pulsed events for output contacts 1 through 6.



Note

By default, the minimum time between any two programmable events is one minute.

- 2 Click the pull-down arrow for Chime repeats, and select the number of times the chime should be repeated (select a number between 1 and 10). Typically this value is normally set to 1, unless you want all programmed chimes to be repeated.

8.7.2 Time settings

- Click the “By system time” radio button, and then the Set button to synchronize the Plena Weekly Timer clock with the PC clock.
- Click the “By input time” radio button, and then the Set button to manually set the Plena Weekly Timer to the required time. Click on the dates and times individually, and use the arrows to adjust the settings.

After clicking the Set button, the new time settings will be uploaded to the Plena Weekly Timer. If the PC and Timer are not connected, a message will be displayed to connect the USB cable.



Note

The Timer also has a clock sync. input for manually synchronizing the time with an external source (see figure 3.4).

During manual synchronization of the Plena Weekly Timer clock, the minutes are pulled to the nearest hour. For example, if the clock is set to synchronize at 13:05, the Timer clock will be set to 13:00. If the clock is set to synchronize at 12:55 the Timer clock will be set to 13:00.

8.8 Schedule programming

Use this button to:

- edit the programming for schedule 1 or 2.
 - upload the edited schedule to the Plena Weekly Timer.
- 1 From the main menu, click the Schedule programming button. The following window will appear (see figure 8.13).

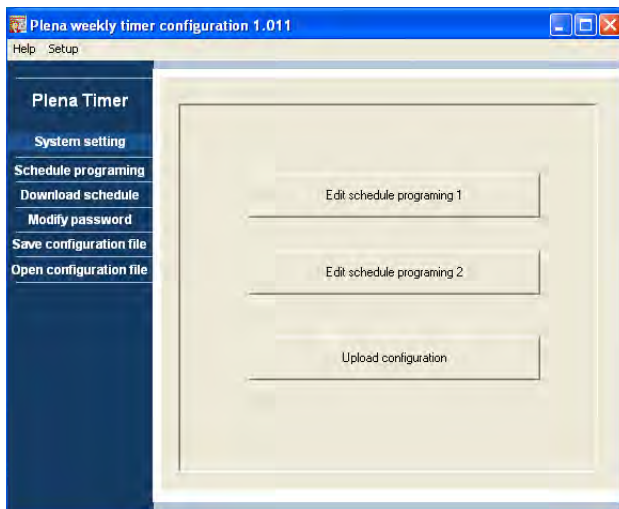

figure 8.13: Programming and upload buttons



Note

The edit program function for schedule 1 and schedule 2 is identical. Therefore for simplicity, only program 1 is explained.

- 2 Click the Edit schedule programming 1 button. The Schedule programming window will appear (see section 8.8.1).

8.8.1 Schedule programming

Use this window to program events.

Events can be:

- scheduled for each day of the week.
- assigned individual properties, such as the time the event takes place, and the type of chime or trigger required (see figure 8.14).

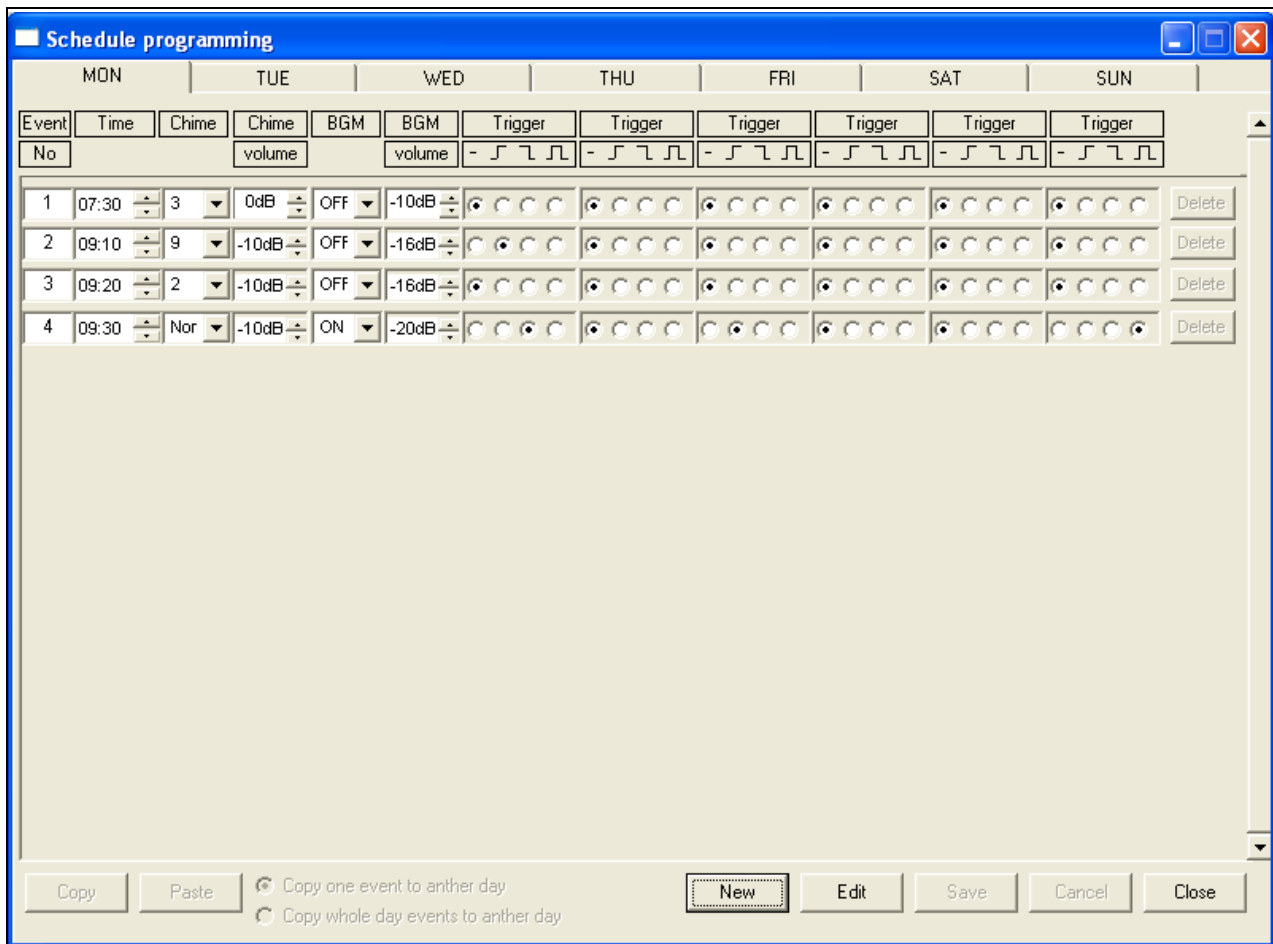

figure 8.14: Schedule programming window

- 1 Click the day tab (at the top of the window) to display the day that you want to update.
- 2 Click the New button to add a new entry, or the Edit button to edit an existing entry. See the explanation of the various fields (Time, Chime, Chime volume, BGM, etc.) on the following page.
- 3 After changing the parameters, click Save to save your settings.

i Note
All parameters will assume the programmed status at the moment the event takes place.

Time

Click the up or down arrow to change the time of a scheduled event. Hours and minutes have to be clicked on, and changed individually.



Note

By default, the minimum time between any two programmable events is one minute.

If you change the time of an event to take place before or after an existing event, the software will ask you if you want to sort the event in the schedule. This means that all events will be re-sorted according to the time. You can select either YES or NO. Normally it is more useful to have events sorted according to time.

Chime

Click the pull-down arrow to select a chime type between 1 and 14 (see table 7.1 for an overview of the chime types). None can also be selected. Short chimes can also be set to repeat within the same minute in the Global system settings (see section 8.7 for more information).

Chime volume

Click the up or down arrow to change the volume of the selected chime.

BGM

Click the pull-down arrow to set the Back Ground Music (BGM) either ON or OFF.

BGM volume

Click the up or down arrow to change the volume of the BGM.

Trigger

The Plena Weekly Timer has six output contacts (see figure 3.4). Each output has four trigger settings (see table 7.2).

Delete

Click on an entry to select it. An orange box will appear around the event to show that it is selected. Click the Delete button to delete the entire entry.

Copy and Paste

Use the Copy and Paste buttons to copy single events, or all the events of one day, to another day.

To copy and paste single events to another day:

- 1 Click the day tab (at the top of the window) that you want to copy from.
- 2 Click the Edit button.
- 3 Click on the event that you want to copy. An orange box will appear around the event to show that it is selected.
- 4 Click the “Copy one event to another day” radio button.
- 5 Click the Copy button.
- 6 Click the day tab (at the top of the window) that you want to paste to.
- 7 Click the Paste button. The copied event will be inserted.

To copy and paste all the events of one day to another day:

- 1 Click the day tab (at the top of the window) that you want to copy from.
- 2 Click the Edit button.
- 3 Click the “Copy whole day events to another day” radio button. Orange boxes will appear around all of the events.
- 4 Click the Copy button.
- 5 Click the day tab (at the top of the window) that you want to paste to.
- 6 Click the Paste button. The copied events will be inserted.

8.8.2 Upload configuration

Use this option to upload the edited schedule from the PC to the Plena Weekly Timer.

- 1 From the main menu, click the Schedule programming button. The following window will appear (see figure 8.15).

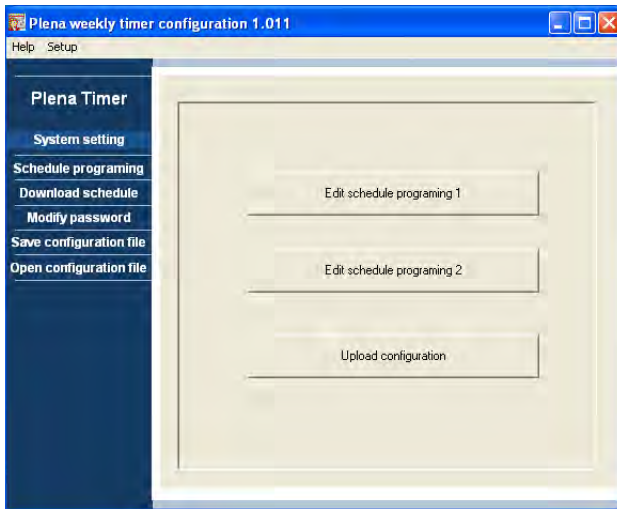

figure 8.15: Programming and upload buttons

- 2 Click Upload configuration. The following window will appear (see figure 8.16) showing that uploading is taking place. When uploading is complete, this window will close.

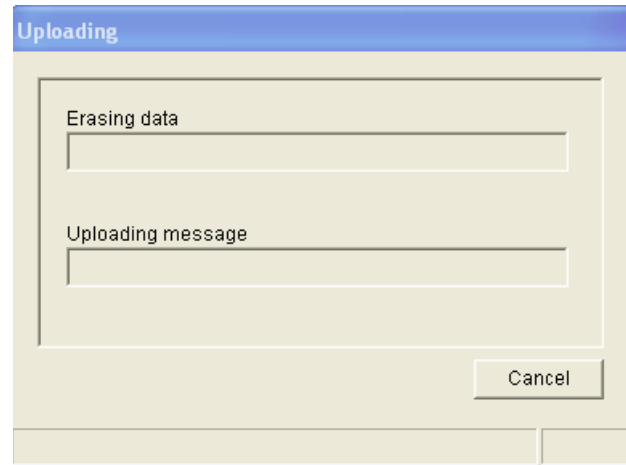

figure 8.16: Uploading data to the Plena Weekly Timer



Note

Make sure you disconnect the USB cable before using the Timer. If you do not disconnect the USB cable, the performance of the Timer might be affected.

8.9 Download schedule

Use this option to download the schedule from the Plena Weekly Timer to the PC.

- 1 From the main menu, click the Download schedule button. The following dialog box will appear (see figure 8.17).

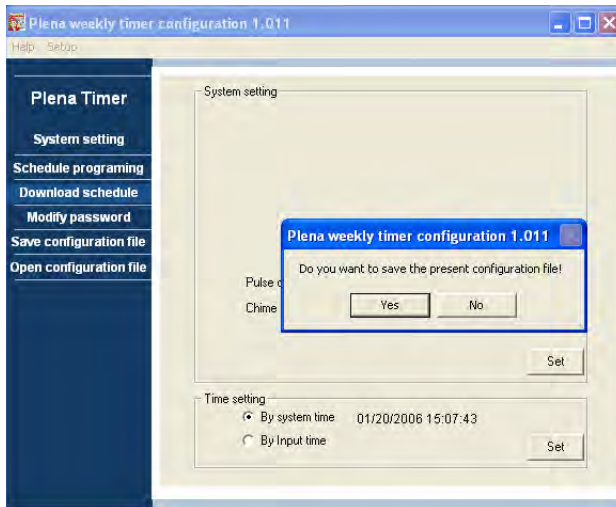

figure 8.17: Download schedule dialog box

- 2 Click either Yes or No to the question “do you want to save the present configuration file?”.



Caution

The downloaded schedule will overwrite the schedule in the PC. If you do not want to lose your settings, you should save the present configuration file.

- If you click Yes, a standard Save As window will appear (see figure 8.18). Select the area where you want to save the configuration file, and then click Save.
- If you click No, the software will start to download the schedule from the Plena Weekly Timer to the PC, and the Downloading window will appear (see figure 8.19). When downloading is complete, this window will close.



figure 8.18: “Save schedule as” window

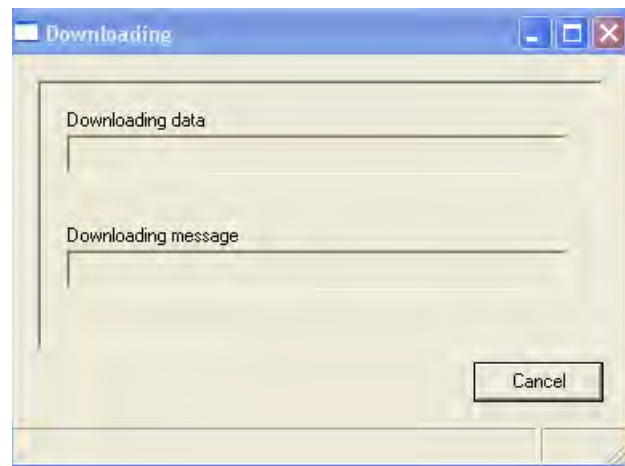

figure 8.19: Download configuration window



Note

Make sure you disconnect the USB cable before using the Timer. If you do not disconnect the USB cable, the performance of the Timer might be affected.

8.10 Modify password

Use the Modify password button to modify the password for accessing the software.

- 1 From the main menu, click the Modify password button. The following window will appear (see figure 8.20).



figure 8.20: Enter password window

- 2 Type in the current password, and then click OK. The default password is 12345678. The following window will appear (see figure 8.21).



figure 8.21: Modify password window

- 3 Type in the new password. The password must have a minimum of four characters. The password is also case sensitive. Therefore, pay attention to capital letters when entering the new password.
- 4 Confirm the password, and then click OK.

8.11 Save configuration file

Use the Save configuration file button to save the current configuration file.

- 1 From the main menu, click the Save configuration file button. The following window will appear (see figure 8.22).



figure 8.22: "Save configuration file as" window

- 2 Select the area where you want to save the configuration file, and then click Save



Note

The default filename is based on the date set in the computer's clock (see figure 8.22).

8.12 Open configuration file

Use the Open configuration file button to open an existing configuration file.

- 1 From the main menu, click the Open configuration file button. The following window will appear (see figure 8.23).



figure 8.23: Open configuration file window

- 2 Select the configuration file that you want to open, and then click Open. The configuration will be loaded, and displayed on the Schedule programming window (see figure 8.14).

9 Technical data

9.1 Electrical

Supply voltage:

115/230 V(AC) \pm 10% ac, 50/60 Hz

Power consumption:

30 Watts

9.2 Performance

Frequency response:

20 Hz - 20 kHz (-3 dB)

Total harmonic distortion:

< 0.01% (1 kHz)

Signal-to-noise:

> 85 dB

Dynamic range:

> 100 dB

9.3 Audio inputs

XLR nominal input

0 dBV (symmetrical)

9.4 Audio outputs

XLR nominal input

0 dBV (symmetrical)

9.5 Mechanical

Mounting

Free-standing or mounted in a 19" rack

Dimensions

(H x W x D) 44 x 483 x 3120 mm

(with brackets, without feet)

48 x 440 x 3120 mm (without brackets, with feet)

Weight

3 kg

Color

Charcoal with silver

9.6 Interconnection

Mains supply

Euro socket with built-in fuse

24DC back-up power

Removable Euro-style screw terminal

System configuration

RJ-45 connector

9.7 Environmental

Operating temperature

-10 to +55 °C

Storage temperature

-40 to +70 °C

Relative humidity

<95%

9.8 Controls and indicators

Front panel

LCD display

Schedule and contact LEDs

Schedule selection

2 push buttons

Contact out selection

6 push buttons

Programming key

3 push buttons

Rotary encoder for volume control and setup menu

Rear panel

Summer/ Winter (daylight saving) time DIP switch

Mains selector 115V/230 V

9.9 Clock accuracy (without sync)

25 °C

Better than 2 seconds a month

-10 °C to 55 °C

Better than 3.5 seconds a month (without sync)

9.10 Power supply

Mains

Euro Mains socket with built-in fuse

24 DC back-up power

Removable Euro-style screw terminal

All contacts

Normally energized (fail-safe)

Connector type

MC 1,5/6-ST-3,5

Rating

250 V 7 A voltage free

9.11 Parts included

PLN-6TMW

Rack mounting brackets

XLR cable

Mains cable (1.7 m)

Instructions for use

Plena bonus CD

Intentionally left blank.

© Bosch Security Systems B.V.
Data subject to change without notice
2006-05 | 9922 141 50741 en

BOSCH