

NetWay3012PX

PoE+ Adapter/Converter



Altronix NetWay3012PX converts 802.3bt (90W) to simultaneous 12VDC/1A and 802.3at PoE+ (25W) outputs for applications including PoE cameras and external microphones, control boards, switching equipment, and more for 60W total output.



NetWay3012PX

Specifications

Input

802.3bt (90W) 4PPoE

Function

Converts 802.3bt (90W) to 802.3at PoE+ (25W) and 12VDC (25W/1A) simultaneously

PoE Port

Single port rated up to 25W max.
IEEE 802.3af, 802.3at compliant
Connectivity: RJ45, auto-crossover
Wire type: 4-pair CAT5e
Distance: up to 100m
Speed: 10/100/1000 Mbps

Power Output

12VDC up to 2A
60W total power combined with PoE

Features

Auto detection and protection of legacy non-PoE cameras/devices
Compact insulated housing

Indicators (LED)

Yellow and Green LEDs: IP Link status,
10/100/1000 Base-T/active
Green LED: PoE ON
Red LED: Power ON

Agency Listings

CE European Conformity

Physical and Environmental

Dimensions (W x L x H)

Enclosure: 3.8" x 2.5" x 1" (96.52mm x 63.5mm x 25.4mm)
Shipping: 8" x 6" x 5" (203.2mm x 152.4mm x 127mm)

Weight (approx.)

Product: 0.25 lb. (0.11 kg)
Shipping: 0.3 lb. (0.14 kg)

Temperature

Operating (90W): -40°C to 75°C (-40°F to 167°F)
Storage: -40°C to 75°C (-40°F to 167°F)

Relative Humidity

85% +/- 5%

Operating Altitude

-304.8 to 2,000m

Accessories

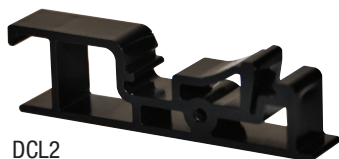

DCL2

DCL2 - DIN Rail Mounting Clip

Allows for easy installation of Altronix adapters utilizing screw mounting holes to mount on a standard DIN rail (Altronix Din Rail models D10, D12, D19, or D24).

Lifetime Warranty



NetWay3012PX

PoE+ Adapter/Converter

Typical Application

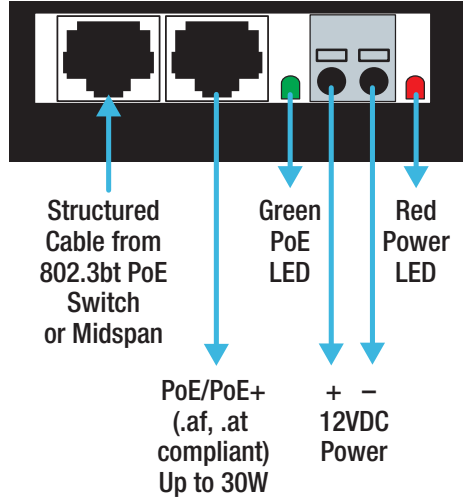

Lifetime Warranty