



Product: [RSWT 5B-228](#)

M12 Standard Sensor/Actuator Single-Ended Cordset: Male, angled, 5-pin, B-coded, orange body, 50 V AC / 60 V DC, 4 A; PUR black cable, 5-wires, 0.50 mm²

Product Description

M12 Standard Sensor/Actuator Single-Ended Cordset: Male, angled, 5-pin, B-coded, orange body, 50 V AC / 60 V DC, 4 A; PUR black cable, 5-wires, 0.50 mm²

Technical Drawing

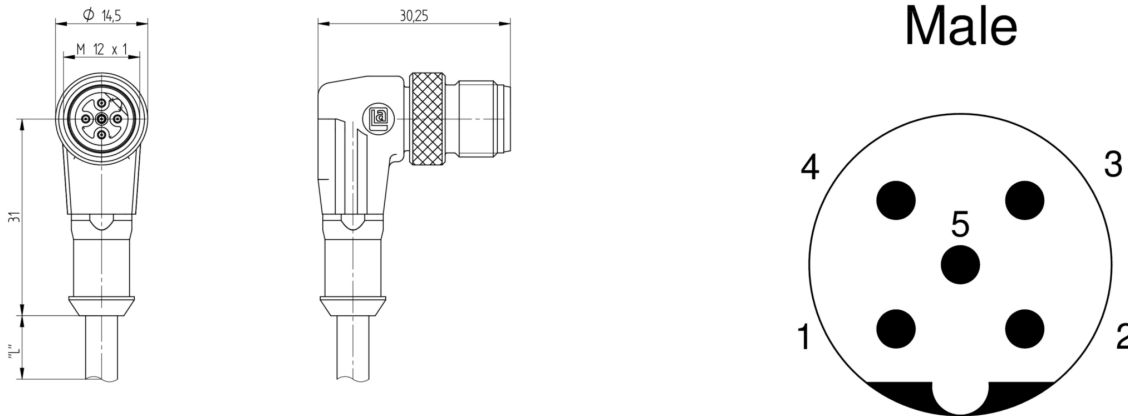

Technical Specifications

Face View

Pin 1	Pin 2	Pin 3	Pin 4	Pin 5
brown	white	blue	black	green-yellow

Technical Data

Product Family:	Sensor / Actuator Connectors
Product Sub Family:	M12 Standard
Brand:	Lumberg Automation
Connector Type:	Cordset, single ended
Type of Contact / Gender:	Male
Connector Design:	Angled
Number of Pins:	5
Coding:	B
Shielding:	Unshielded
Attachment Type:	Coupling Screw
Rated Voltage:	60 V
Rated Impulse Voltage:	1.5 kV
Operating Voltage:	50 V AC / 60 V DC
Rated Current*:	4 A
Contact Resistance:	≤ 10 mOhm
Insulation Resistance:	> 10 ⁹ Ohm

Mating Cycles:	≤ 100
Ambient Temperature (Operation)*:	- 40 °C - + 90 °C
Protection Degree / IP Rating**:	IP65, IP67, IP68 (1 m / 24 h), IP69K
Design Standard:	Pin assignment deviating from IEC 61076-2-101 and IEC 61140
Pollution Degree:	3 acc. to DIN EN 60664-1 (VDE 0110-1)
Overvoltage Category:	III acc. to DIN EN 60664-1 (VDE 0110-1)

Materials

Contact Base Material:	CuZn
Contact Plating:	Cu/Au
Contact Bearer Material:	TPU-GF
Contact Bearer Color:	Orange
Flammability Class (Contact Bearer):	UL 94 HB
Molded Body Material:	TPU
Molded Body Color:	Orange
Flammability Class (Molded Body):	UL 94 HB
Attachment Material:	CuZn
Attachment Plating:	Nickel-plated

Additional Technical Data

Fastening Torque (Attachment):	M 12x1: (50-60) Ncm, hand-tight
--------------------------------	---------------------------------

Cable Data

Cable Number:	228
Conductor Size:	0.5 mm ²
Number of Wires:	5
Minimal Bending Radius (Fixed Inst):	> 5 x D
Minimal Bending Radius (Flexible Inst):	> 10 x D
Cycles (Bending):	> 5 M
Cycles (Torsion):	> 5 M @ ± 360 °/1 m
Conductor material:	Cu
Cable Jacket Material:	PUR
Cable Jacket Color:	black matt similarly RAL 9005
Cable Diameter D:	ø 5.40 ± 0.20 mm
Wire Insulation Material:	PP
Insulated Wire Diameter:	ø 1.50 ± 0.05 mm
Ambient Temperature (Fixed Installation):	- 50 °C - + 105 °C (UL: + 80 °C)
Ambient Temperature (Flex Installation):	- 25 °C - + 105 °C (UL: + 80 °C)
Ambient Temperature (Drag Chain Inst):	- 25 °C - + 60 °C
UL Cable Type:	AWM: 20549
Flammability Class (Cable Jacket):	DIN EN 60332-2-2, VDE 0482-332-2-2, IEC 60332-2-2, CSA FT-2
Cable Characteristics:	Good microbes and hydrolysis resistance; Mainly plasticizer diffusion free; Exclusion of PVC and silicone; Free of lacquer wetting disturbing substances; Coldness flexibility
Core Colors:	brown, white, blue, black, green-yellow

Safety & Environmental Compliance

RoHS Compliant:	yes
-----------------	-----

Resistances

Halogenfree:	DIN EN 50267-2-1, IEC 60754-1, VDE 0482-267-2-1
Oil Resistance:	IEC 60811:404

Notes

Note Derating:	Notice derating
Protection Degree / IP Rating Note:	** only if mounted and locked in combination with Hirschmann / Lumberg Automation connector.
Note:	Do not connect or disconnect under load.

Variants

Item #	Item Description	Cable Length	Rated Current
9155	RSWT 5B-228/1 M	1 m	4 A

© 2025 Belden, Inc

All Rights Reserved.

Although Belden makes every reasonable effort to ensure their accuracy at the time of this publication, information and specifications described here in are subject to error or omission and to change without notice, and the listing of such information and specifications does not ensure product availability.

Belden provides the information and specifications herein on an "ASIS" basis, with no representations or warranties, whether express, statutory or implied. In no event will Belden be liable for any damages (including consequential, indirect, incidental, special, punitive, or exemplary damages) whatsoever, even if Belden has been advised of the possibility of such damages, whether in an action under contract, negligence or any other theory, arising out of or in connection with the use, or inability to use, the information or specifications described herein.

All sales of Belden products are subject to Belden's standard terms and conditions of sale.

Belden believes this product to be in compliance with all applicable environmental programs as listed in the data sheet. The information provided is correct to the best of Belden's knowledge, information and belief at the date of its publication. This information is designed only as a general guide for the safe handling, storage, and any other operation of the product itself or the one that it becomes a part of. The Product Disclosure is not to be considered a warranty or quality specification. Regulatory information is for guidance purposes only. Product users are responsible for determining the applicability of legislation and regulations based on their individual usage of the product.