

VIVOTEK
A Delta Group Company

IP Camera Series

User Manual

Introduction

The VIVOTEK CD9381-HNTV and CD9381-HNVF2 are 5MP corner dome AI cameras designed specifically for indoor high-security environments such as correctional facilities, detention centers, and behavioral health institutions. With an anti-ligature form factor and compact triangular housing, these models are engineered to minimize risk and tampering in challenging surveillance applications.

Both cameras feature a 5-megapixel sensor for high-resolution video capture, enhanced by built-in invisible 940nm IR illuminators effective up to 10 meters, ensuring discreet night vision without red-light exposure. The wide dynamic range (WDR Pro) ensures visibility in high-contrast lighting conditions. The CD9381-HNTV is equipped with a remote focus and vari-focal lens for flexible field-of-view adjustment, while the CD9381-HNVF2 offers a fixed wide-angle 2.4 mm lens for broader area coverage.

Certified with IP6K9K/IP67 and IK10 protection, both models offer superior resistance against water, dust, and physical impact. Built-in microphones enable audio monitoring, while cybersecurity is enhanced with Trend Micro IoT security integration.

With their intelligent design, durable construction, and AI-driven capabilities, the CD9381-HNTV and CD9381-HNVF2 are the ideal choices for facilities requiring safe, secure, and efficient indoor surveillance.

Revision History

Doc. Ver.	Rel. date	F/W Ver.	Comment
r1.9_250411	2025/04/11	1.2402.43.01g and above	Release for new Camera WebUI.

Read Before Use

The use of surveillance devices may be restricted by law in your country or region. The Network Camera is not only a high-performance web-ready camera but also a part of a flexible surveillance system. Before installing this device for its intended use, it is the user's responsibility to ensure that its operation complies with local laws and regulations.

Before installing the Network Camera, ensure that all contents are complete by referring to the **Package Contents** list in the **Quick Installation Guide (QIG)** included in the packaging. It is also essential to read the warnings provided in the guide and follow the instructions regarding installation details to avoid damage caused by improper assembly or installation. Doing so ensures that the device operates as intended.

The network camera features an intuitive design, making it simple and easy to operate for users with basic networking knowledge. Its settings interface is categorized by functions such as **Image, Video & Audio, Detection, Recording, and System**. The camera supports various applications, including security surveillance and video monitoring. Through the available configuration options, users can customize the camera's performance, optimize its features, and ensure proper operation. For advanced users and developers, the structured menu system and **App** settings provide flexibility for integrating the camera into existing systems or enhancing specific functionalities.

VIVOTEK camera models

The following VIVOTEK camera models are applicable to this user manual:

- CD9381-HNTV
- CD9381-HNVF2

IMPORTANT:

The equipment comes with a RTC battery. Note the following:

High or low extreme temperatures that a battery can be subjected to during use, storage or transportation; and low air pressure at high altitude.

Replacement of a battery with an incorrect type that can defeat a safeguard (for example, in the case of some lithium battery types).

Disposal of a battery into fire or a hot oven, or mechanically crushing or cutting of a battery, that can result in an explosion.

Leaving a battery in an extremely high temperature surrounding environment that can result in an explosion or the leakage of flammable liquid or gas.

A battery subjected to extremely low air pressure that may result in an explosion or the leakage of flammable liquid or gas.

CAUTION:

Risk of fire or explosion if the battery is replaced by an incorrect type.

Topic of Content

Get started

- **Using Device Manager to Locate and Identify Cameras on the LAN**
- **Using Shepherd to Locate and Identify Cameras on the LAN**
- **Using the Camera Web UI for First-Time Access**
 - Set a New Password for the Root User
 - Log In to the Camera Web UI
 - Introduction to the Camera Web UI

Installation

- **Using the Video Stream Toolbar**
- **Using the Installation Panel to Quickly Adjust the Camera**
 - Control
 - PTZ

Image

- **Enhancing Image Quality with VIVOTEK Camera Settings**
 - General Settings
 - Illuminators
 - Image
 - Exposure
- **Using Privacy Masking to Safeguard Confidential Information in Images**
 - Privacy mask settings
- **Customizing Image Overlays to Add Additional Information**
 - Overlay
 - Advanced

Topic of Content

Video & Audio

- **Optimizing Surveillance Efficiency with Flexible Video Settings**
 - Mode
 - Stream
- **Configuring Audio Settings for Enhanced Input and Output Performance**
 - Audio settings
 - Audio clips
- **Configuring Media Profiles to Optimize Video Performance for Versatile Applications**
 - Media profile

PTZ Settings

- **Effortlessly Manage and Customize PTZ Settings for Precise Camera Control**
 - Home & Preset
 - Patrol
 - Preference

App

- **Expand Camera Functionality with Powerful Applications**
 - Event action through HTTP/HTTPS
 - Trend Micro IoT Security
 - Deep Learning VCA

Detection

- **Smart VCA: Advanced Video Analysis for Proactive Security and Precision Monitoring**
- **Smart Motion: Enhanced Accuracy and Efficiency in Surveillance with Smart Motion Detection**
- **Audio Detection: Enhancing Security with Real-Time Audio Anomaly Detection for Prompt Response**
- **Shock Detection: Ensuring Real-Time Protection Against Physical Impact**
- **Tampering Detection: Protecting the Surveillance System from Visual Obstruction**

Topic of Content

Event

- **Event: Enhancing Security with Automated and Customizable Event**
- **Camera link: Enhance Multi-Camera Coordination and Eliminate Blind Spots with Camera Link**
- **Trigger Automated HTTP/HTTPS Requests for Event-Based Integration**
- **Event server & media: Effortless Event Management and Enhanced Security with Event Server & Media**

Recording

- **Recording: Maximize Surveillance and Storage with Tailored Recording Settings**

System

- **Device: Centralized Management for System Monitoring and Camera Configuration**
- **Configure and Secure Your Camera's Network Connection for Seamless Communication**
 - Network Settings
 - Protocol
 - Service
 - Security
- **Manage User Access and Permissions for Enhanced Security and Control**
 - User
 - Privilege
 - Account block
- **Maintenance: Firmware Updates and Configuration Management for System Maintenance**
- **Storage: Optimized Storage Solutions for Reliable Video Recording and Data Retention**
- **File: Effortless Management and Retrieval of Recorded Media**
- **Monitoring and Managing System Logs and Parameters**
 - Logs
 - Audit log
 - Parameter
- **Theme settings: Customizing Interface Appearance and Branding with Theme Settings**

Appendix A. DI/DO Configuration Guide

Get started

After installing the camera, you can quickly find the IP address of the camera on the local network using the Device Manager or Shepherd provided by VIVOTEK to access the camera web UI for video monitoring and various camera settings. Plus, when you access the camera web UI for the first time, you can set your own password policy for the camera to enhance information security.

Using Device Manager to Locate and Identify Cameras on the LAN

The Device Manager is a device management tool that facilitates the installation and configuration of multiple VIVOTEK devices (primarily for VIVOTEK cameras) through a client-server framework. This allows device management and maintenance to be performed remotely by installing and using the Device Manager client. Here, users can use Device Manager to locate the IP address of the camera they wish to operate within their local network.

Step 1.

Download and install the Device Manager application from VIVOTEK's official website. (https://www.vivotek.com/products/software/device_manager)

Step 2.

Run and log in to the Device Manager application.

Step 3.

On the Camera tab, click Add Device to let Device Manager detect cameras on the LAN.

Step 4.

Select the camera to operate based on its MAC address, then click Add.

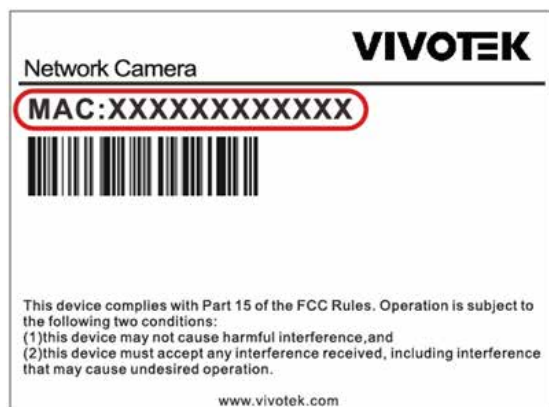

Note:

Here, users can also note the camera's IP address and directly enter it in a browser to access the Camera web UI.

Get started

Step 5.

Double-click the camera item you wish to operate, and the Camera web UI will open in the browser.

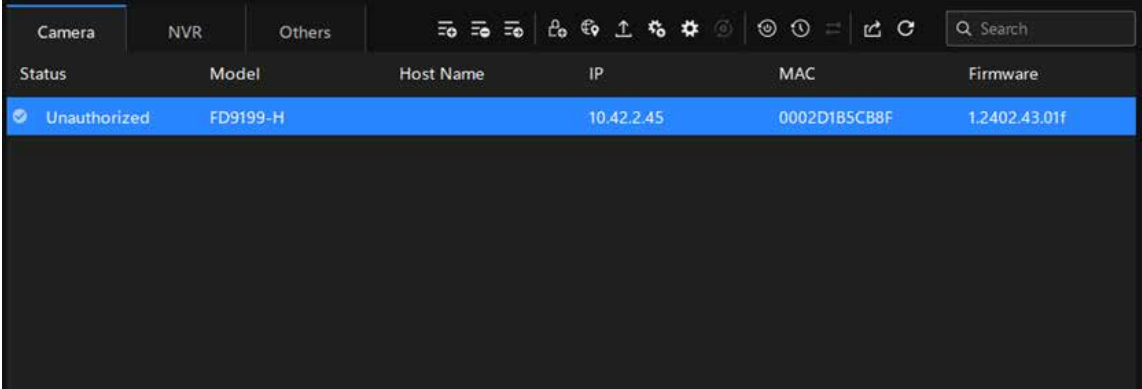

Status	Model	Host Name	IP	MAC	Firmware
Unauthorized	FD9199-H		10.42.2.45	0002D1B5CB8F	1.2402.43.01f

Get started

Using Shepherd to Locate and Identify Cameras on the LAN

The Shepherd utility is an installation and management tool that helps facilitate the configuration of multiple cameras. The tool can be used to automatically search the network for cameras, assign IP addresses, display connectivity, manage firmware/software upgrades, and collectively configure multiple cameras.

Here, users can use Device Manager to locate the IP address of the camera they wish to operate within their local network.

Step 1. Download and extract the Shepherd application from VIVOTEK's official website. (<https://www.vivotek.com/products/software/shepherd>)

Step 2. Locate and run the Shepherd application.



Step 3. Click refresh icon to detect all devices on the LAN.

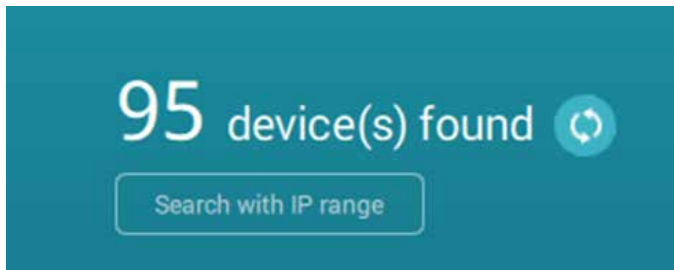

Step 4. Select and double-click the camera to operate based on its MAC address, and the Camera web UI will open in the browser.

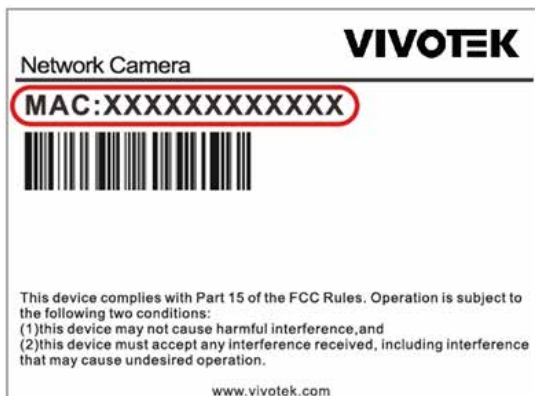

Note:

Here, users can also note the camera's IP address and directly enter it in a browser to access the Camera web UI.

Get started

Using the Camera Web UI for First-Time Access

Set a New Password for the Root User

When users access the Camera web UI for the first time, they must set a new password for the default root account. If necessary, they can also adjust the password policy for all users of the Camera web UI at this point.

Step 1. Enter the new password for the root account in the “Password” field to be used as the root login password from now on.

Note:

At this point, users can click the edit icon to configure the password policy for all users when setting passwords in the Camera web UI.

The image shows two side-by-side configuration screens. The left screen is titled "Set new password" and contains the following fields and options: "User name" (root), "Password" (Enter password), "Password Policy" (with three error messages: "At least 8-64 characters with no spaces.", "At least one alphabetic character", and "At least one numeric character"), "Strength" (a progress bar from Strength to Weak), "Confirm Password" (Re-enter password), a checked checkbox for "Block account when consecutive login fails is detected", and a language dropdown menu set to "English". The right screen is titled "Password Policy" and contains the following rules: "At least 8~64 characters with no spaces.", "At least one alphabetic character" (checked), "At least one special character including !%-.@^_~" (unchecked), "At least one numeric character" (checked), "At least one lowercase character" (unchecked), "At least one uppercase character" (unchecked), and "Prohibition of a password that is the same as the username" (unchecked). There are "Save" and "Cancel" buttons at the bottom right of the "Password Policy" screen.

Step 2. Re-enter the new password in the “Confirm Password” field for confirmation.

Step 3. Confirm whether the “Block account when consecutive login failures are detected” mechanism is enabled.

Note:

By default, if the password is entered incorrectly five consecutive times within 20 seconds, the account will be blocked for 300 seconds. User can customize the detailed settings from System > User Accounts > Account block later.

Step 4. Set the language used in the Camera web UI.

Get started

Step 5. Please carefully read the Trend Micro End User License Agreement and click Agree button.

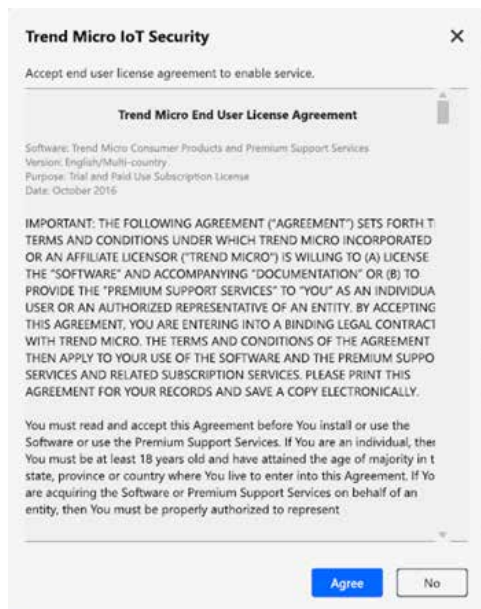

Step 6. Click Save button.

Log In to the Camera Web UI

After setting the new password, the user can log in to the Camera web UI with the root account for first use.

Step 1. Use root account and password to log in when accessing the Camera web UI for the first time.

Login

User name

root

Password

.....



Language

English



Login

Get started

Step 2. After accessing the Camera web UI, please carefully read the **System Use Notification** message and agree to its content before proceeding with the configuration and operation of the camera through the Camera web UI.

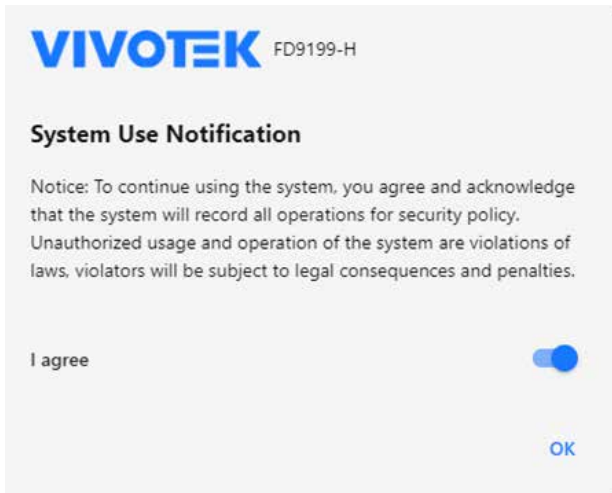

Audio Playback Security Notification:

The Audio Playback Security Notification is designed to ensure the privacy and security by preventing audio from playing automatically when entering a video streaming page.

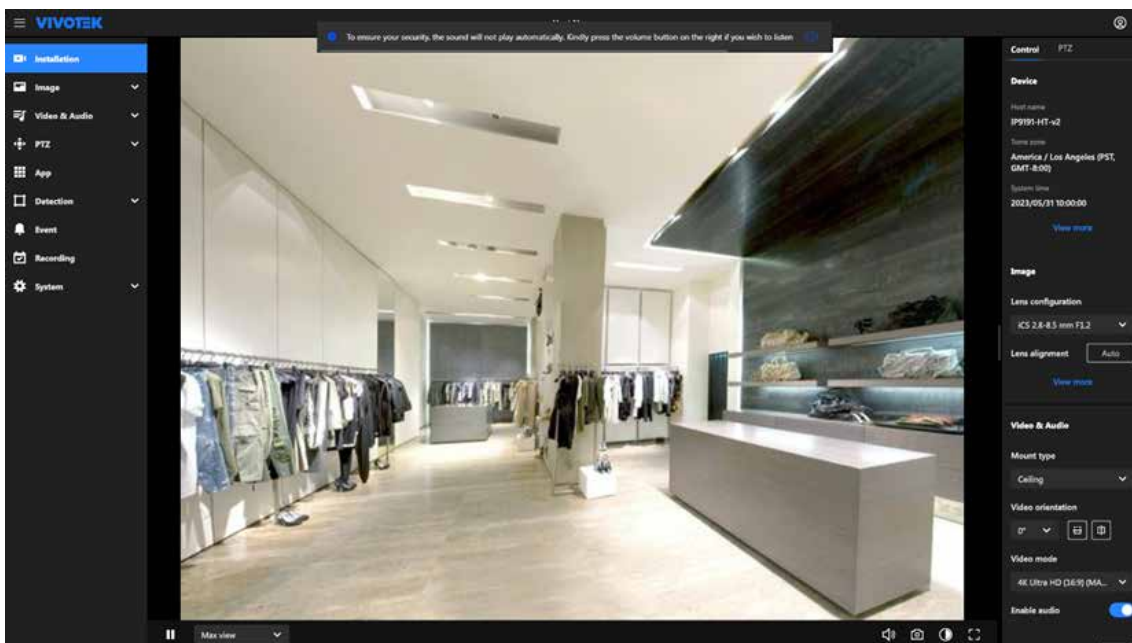

The notification appears when a user logs into the VIVOTEK Camera WebUI with active Video Streaming, specifically to prevent unintended audio playback without consent.

Get started

 To ensure your security, the sound will not play automatically. Kindly press the volume button on the right if you wish to listen 

If the user takes no action, the notification will automatically disappear after 20 seconds; however, if the user clicks the Volume button (icon) to enable audio, the notification will disappear immediately.

Note:

If multiple notifications appear simultaneously (e.g., success or failure messages), these additional notifications will be displayed below the primary message without overriding or covering this security notification.

Introduction to the Camera Web UI

The Camera web UI screen is mainly composed of three parts: the title bar, the navigation bar, and the content display.

- **The title bar**

Primarily serves as the title display for the Camera web UI, allowing users to quickly identify it. The functions are arranged from left to right as follows.



Menu expansion/collapse button

Allows control over menu expansion or collapse to maximize the display of image content or settings interface, providing a better experience for users when operating the camera.

Logo

By clicking the VIVOTEK logo, users can quickly access the VIVOTEK official website for more product information. Users can also customize the logo and link displayed in **System > Theme > Logo**.

Host name

The Camera web UI displays the model name as the default host name. Users can go to **System > Device > Information** to modify the name to something more identifiable.

Account information

Users can view the current login account information and the associated role permissions here. They can also adjust the system language to their preference at any time.

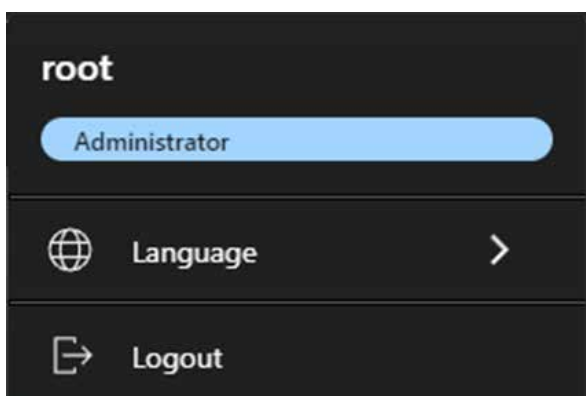

Get started

- **The navigation bar**

Functions and settings within the Camera web UI are centrally categorized to help users quickly locate the desired configuration items.

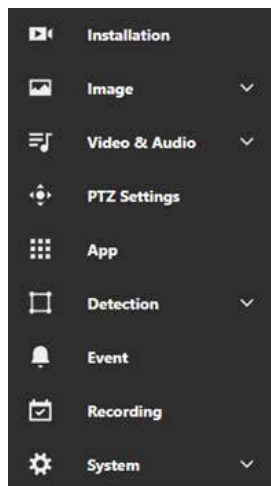

Installation

The Installation section helps users set up and fine-tune the camera by providing options for positioning, focus, and initial configuration to ensure proper alignment and operation.

Image

The Image section allows users to adjust image quality and appearance, including settings for brightness, contrast, saturation, sharpness, exposure, white balance, and orientation to ensure optimal video output.

Video & Audio

The Video & Audio section allows users to configure video settings such as resolution, bitrate, frame rate, and codecs, as well as manage audio options like enabling recording, selecting codecs, and configuring microphone or speaker settings.

PTZ Settings

The PTZ Settings section allows users to manage pan, tilt, and zoom functions by configuring movement speed, preset positions, and patrol patterns for precise and smooth camera control.

App

The App section allows users to manage VIVOTEK-specific applications or plugins, using these applications to expand the camera's functionality.

Detection

The Detection section leverages AI-powered algorithms provide comprehensive monitoring capabilities, including Smart VCA features like line crossing, intrusion, as well as Motion Detection, Audio Detection, Shock Detection, and Tampering Detection. Users can configure detection zones, sensitivity, and event triggers to ensure accurate, intelligent monitoring and enhanced security for various scenarios.

Get started

Event

The Event section allows users to define event triggers and conditions, configuring actions such as sending notifications, recording video, or activating alarms to respond effectively to specific events.

Recording

The Recording section allows users to configure recording modes, such as continuous, event-based, or scheduled recording, and set storage locations like SD cards or network storage to manage video footage efficiently.

System

The System section provides tools for managing device settings, network configurations, user accounts, maintenance tasks, storage options, logs, and interface customization to ensure optimal performance, security, and usability of the camera.

- **The content display**

This area serves as the main workspace of the Camera web UI, where the layout and content change based on the different categories selected on the navigation bar. The following operational instructions in this document will focus primarily on this section.

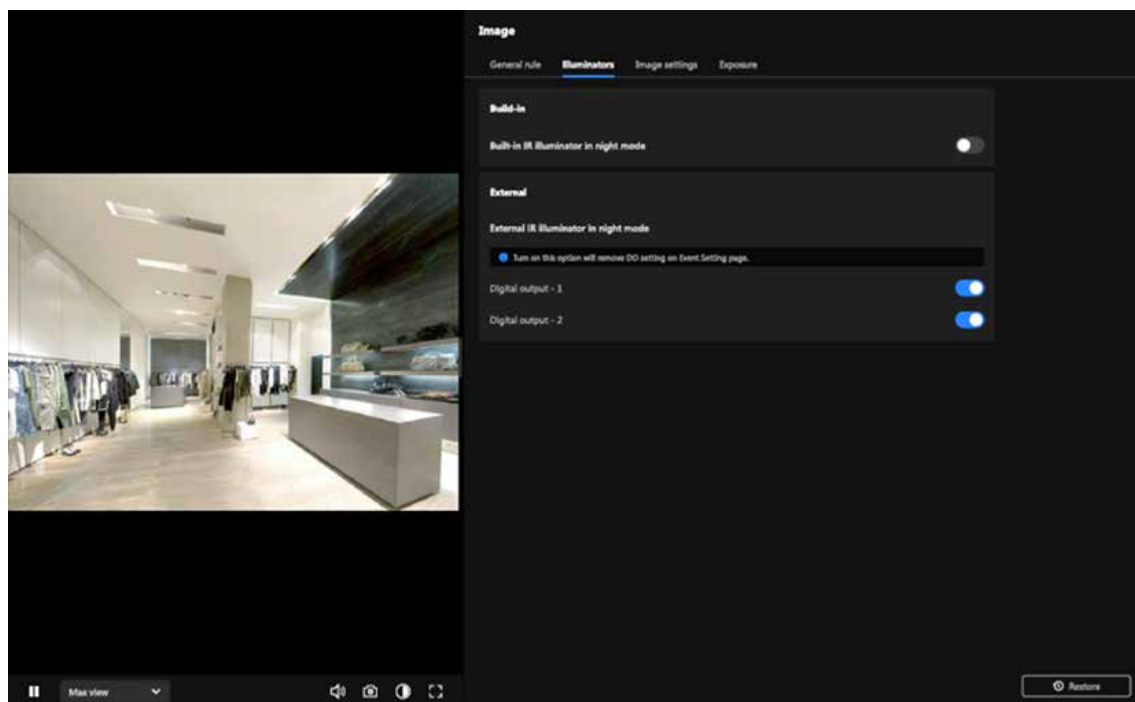

Installation

This category serves as the first screen upon entering the Camera Web UI. Its primary purpose is to assist users in quickly and conveniently setting up the desired monitoring view under the Installation category after installing the camera.

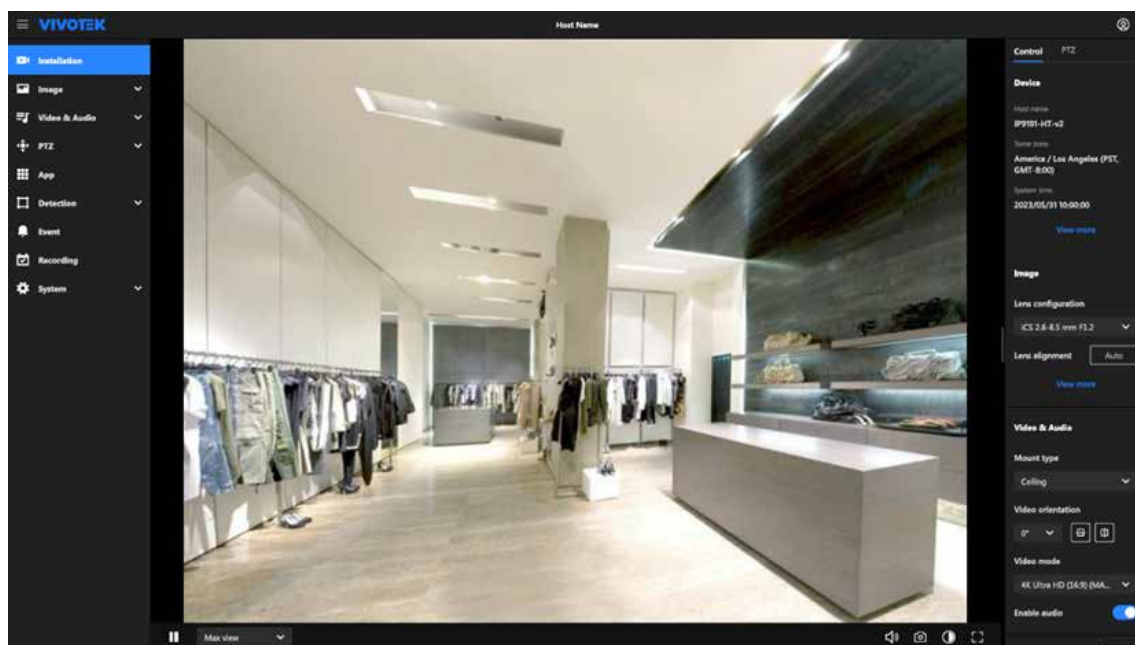

Navigating the Video Stream Toolbar for Enhanced Control

The Video Stream Toolbar is located at the bottom of the Camera Web UI, providing users with various features that can be used in real time during video streaming. The functions are arranged from left to right as follows.



Pause / Play button

When users want to view or confirm the details presented in the video streaming image, they can press the Pause button at any time to **pause** the image. Pressing **Play** button again will resume the video streaming playback.

Media profile menu

Users can quickly switch between the three different media profiles—**Recording**, **Live View**, and App View—based on different situational needs, reducing the time required for video settings. Users can also add or modify media profiles in **Video & Audio > Media Profile**.

Focus area zoom

Focus Area Zoom allows users to magnify a specific portion of the screen while maintaining an overview of the entire image in a smaller navigation window, enabling precise inspection and effortless navigation.

Installation

Volume adjustment

Users can adjust the volume of the video streaming according to their needs.

Snapshot button

Users can capture images from video streaming at any time.

Night/Day mode switch

Users can switch the video streaming display to Black & White or Color mode according to the current scenario, such as nighttime or daytime.

Full screen display

Users can display the video streaming image in full-screen mode.

Installation

Efficiently Adjust Camera Settings via the Installation Panel

The Installation panel provides commonly used and essential information, along with quickly adjustable settings, to help users complete the camera installation and setup more efficiently and conveniently. Additionally, the adjusted settings are instantly reflected on the video streaming display.

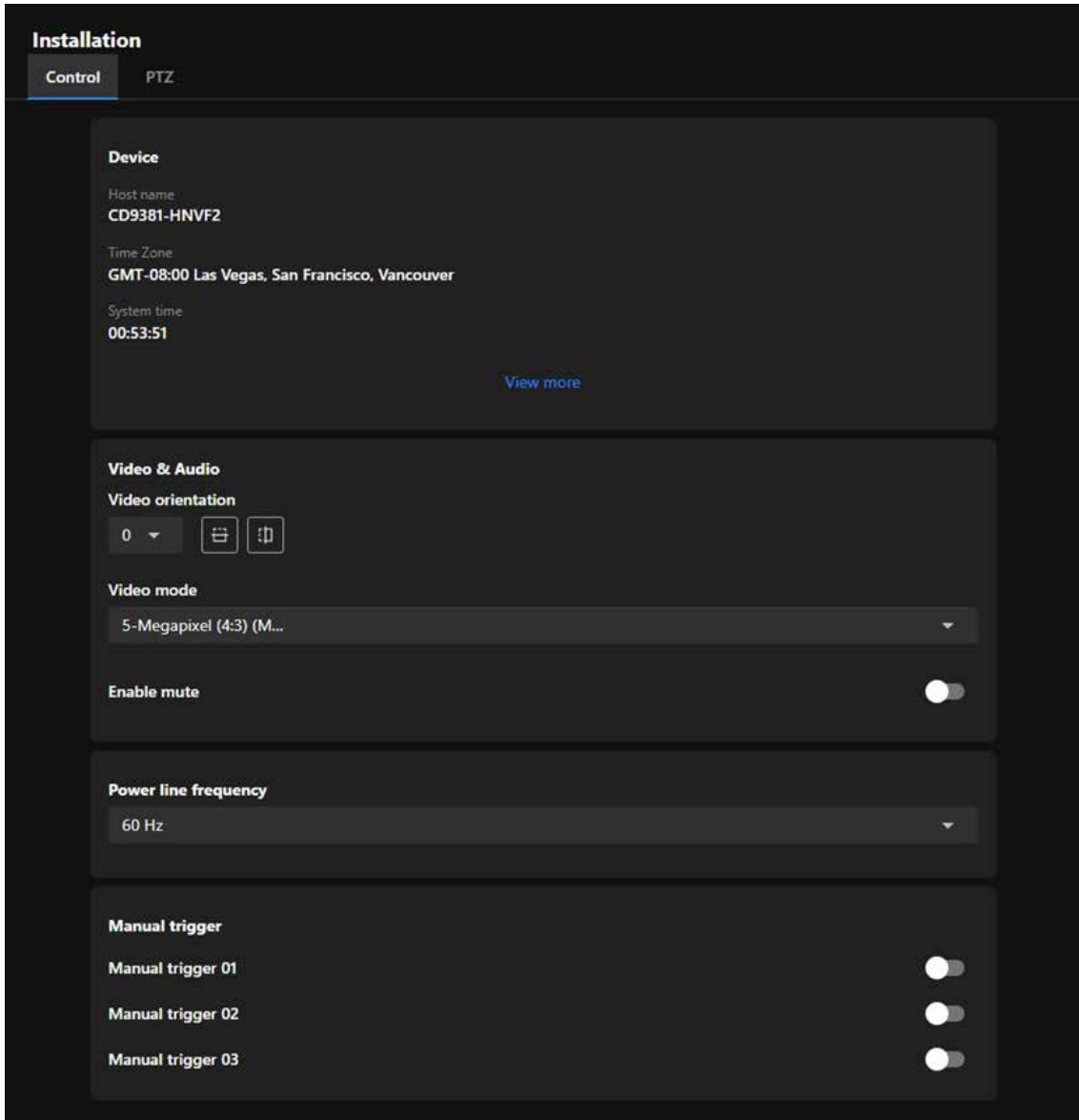

Control panel

Essential settings and functions required during the camera installation process are integrated into the Control Panel to ensure that users can view the desired display effects while installing the camera.

Installation

- **Device:**

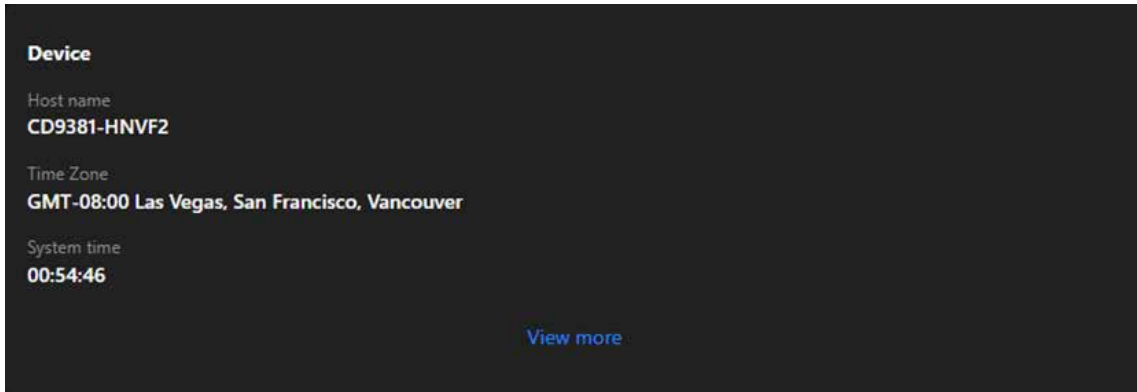

The Device card serves as a quick reference for critical device information, helping users ensure the camera's identity, time zone, and system time are correctly configured for seamless operation and event tracking. Additionally, clicking "View More" will navigate to System > Device > Information for further adjustments.

- **Video & Audio:**

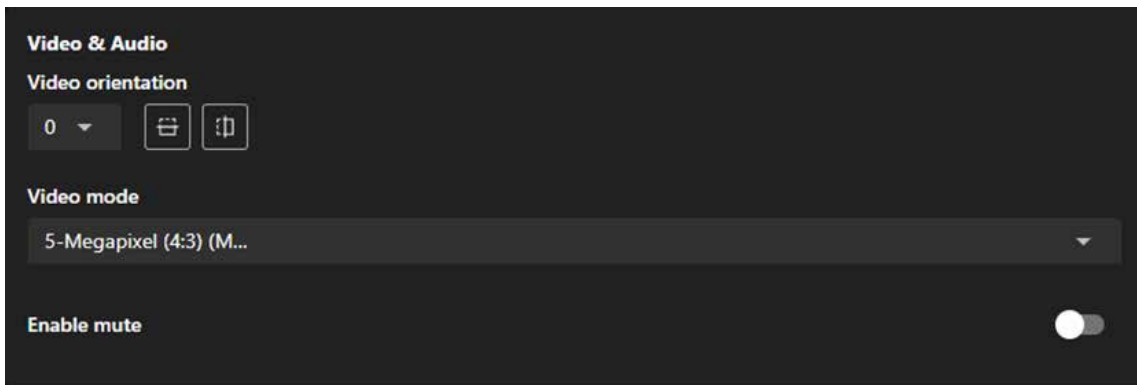

Installation

Video orientation

The camera may be installed on a vertical, side-facing, or tilted surface to accommodate the interior or exterior design of a building. The interior of a building may be shaped as a narrow rectangular space, such as a corridor. A conventional HD image, such as one with a 16:9 aspect ratio, may be incongruous due to its wide horizontal view. With video rotation, the camera can more effectively cover the field of view in a tall and narrow scene.

Rotate	The rotation here indicates clockwise rotation. Rotation can be applied with flip, mirror, and physical lens rotation settings to adapt to different mounting locations.
Flip	Vertically reflect the display of the live video.
Mirror	Horizontally reflect the display of the live video.

Video mode

Refers to the image processing modes used by IP cameras during video recording and transmission. These modes are adjusted based on monitoring environments, network bandwidth, storage requirements, and application scenarios to enhance image clarity and smoothness, achieving optimal performance and efficiency under various network conditions.

Enable mute

Provides the option to enable or disable audio recording, where toggling it on mutes the camera audio to prevent any audio capture.

Installation

- **Power line frequency:**

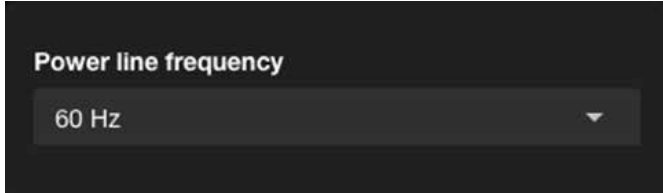

The Power line frequency setting ensures stable video quality by allowing users to align the camera's frequency with the local power grid, effectively preventing flicker in areas with fluorescent or artificial lighting; selecting the correct frequency, such as 60 Hz for North America or 50 Hz for many European and Asian countries, helps eliminate video flicker caused by power line interference.

- **Manual trigger:**



Allows users to manually enable event triggers by clicking the on/off button on the Installation panel. Before using this function, please add events associated with Manual Trigger 01 to 03 in the Event category.

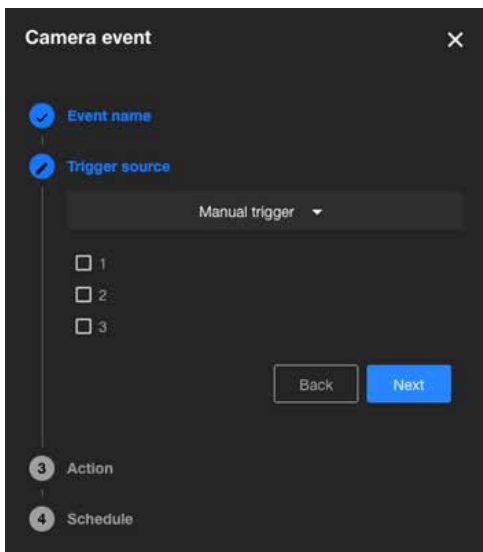

Installation

- Pixel calculator:

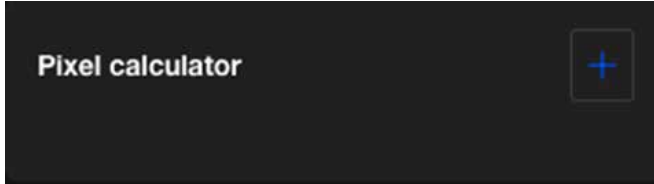

Click the "Add" button to create a pixel calculator window. Move your cursor over the window to position it in the area of interest, and adjust the window size to fit the area. Once the window is configured, the pixel count on its edges will be displayed, assisting you in assessing whether the current configuration meets the requirements.

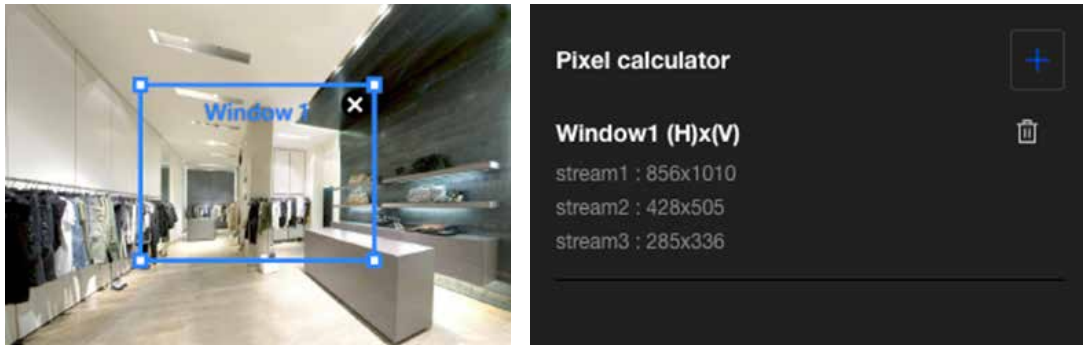

Using this visual tool, you can estimate the coverage area, the distance to the target, and place a ruler or an object of known size. Then, you can draw a calculator frame to cover the subject of interest. The calculated values will be listed at the bottom of the screen, helping you determine whether the current settings meet the pixel count requirements.

Installation

PTZ panel

The PTZ panel provides users with a convenient way to adjust the monitored image position by operating the pan, tilt, and zoom functions, and quickly switch between preset positions to monitor key areas; however, the PTZ function is only supported on the 2nd and 3rd media profiles, and users need to select a supported stream for it to work.

- **PTZ control:**

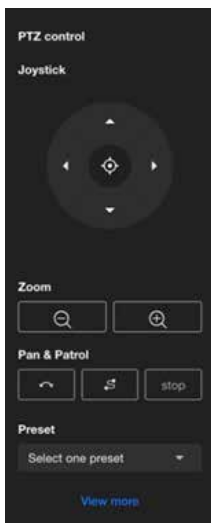

Joystick

Users can move the monitored area's image by operating the joystick, adjusting the view to the desired monitoring area. Additionally, pressing the **Home** button will restore the view to the preset Home position. Users can set the position represented by Home in **PTZ Settings > Home & Preset**.

Zoom

Users can use the Zoom button to freely zoom in or out on the current monitoring screen to an appropriate size.

Pan & Patrol

When the user clicks the **Pan** button, the monitoring screen will move left and right, centering on the current view, to expand the surveillance range. By clicking the **Patrol** button, the monitoring screen will move sequentially to each observation point according to the preset order and time intervals, enabling automatic surveillance of multiple areas. Users can configure the desired preset positions and time intervals for patrol on the **PTZ Settings > Patrol page**. Click **Stop** button to halt the current monitoring screen's Pan or Patrol.

Preset

Users can quickly switch the current monitoring perspective by selecting a screen set as a Preset. Users can configure the Preset positions on the **PTZ Settings > Home & Preset page**.

Image

The Image provides various image adjustment options, including General Settings, Privacy Mask, and Overlays, to meet the needs of different scenarios. These settings can enhance image performance, protect privacy, and add supplementary information.

Optimizing Image Quality with VIVOTEK Camera Settings

The General Settings for images are typically used to adjust and optimize the parameters of cameras or imaging systems to ensure that the generated images meet the required specifications. These settings can be divided into four main categories: General, Illuminators, Image, and Exposure. Below is a brief introduction to each category.

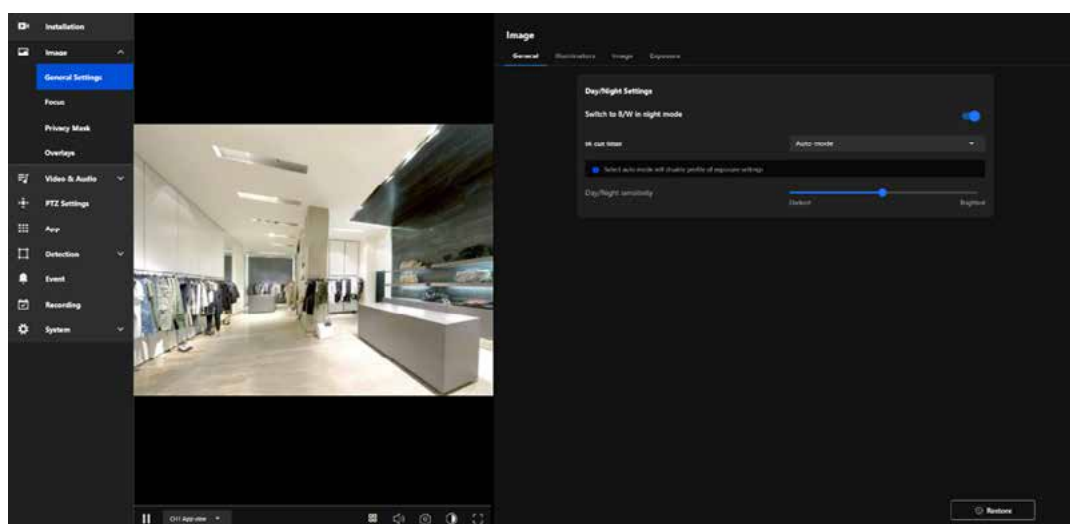

General

In the General page provides users with core features to adjust image quality, ensuring optimal camera performance in various environments.

- **Day/Night Settings**

The purpose of the Day/Night Settings is to enhance the imaging quality of cameras under different lighting conditions.

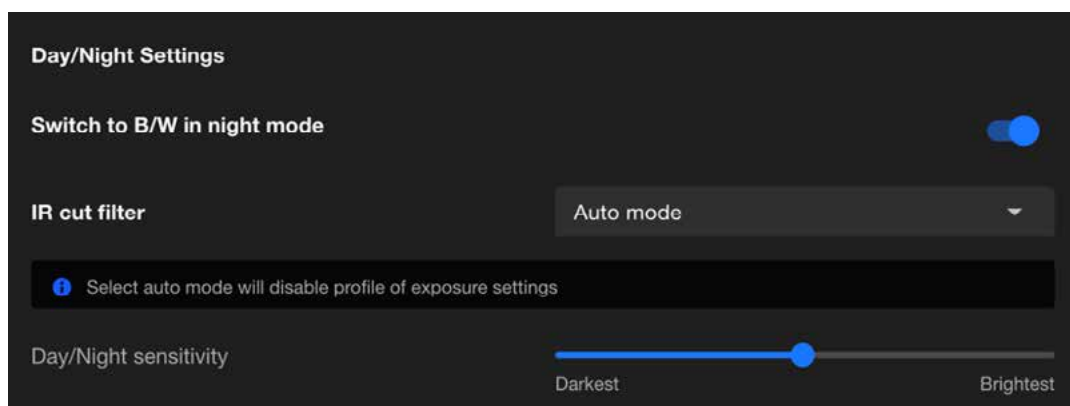

Image

Switch to B/W in night mode

After enabling this feature, the camera will automatically switch to black-and-white display in night mode. This design aims to enhance image clarity and contrast in low-light conditions, ensuring clear surveillance footage even in insufficient lighting.

IR cut filter

The IR cut filter is a removable filter that blocks infrared light from entering the image sensor during the day to prevent color distortion in images. In night mode, the camera automatically removes this filter, allowing infrared light to enter the image sensor. This works with built-in or external infrared illumination to enhance image sensitivity in low-light or no-light conditions, providing clearer night surveillance footage. The available modes for the IR cut filter are as follows:

- **Auto mode(Select auto mode will disable profile of exposure settings)**

The Network Camera automatically removes the filter by judging the level of ambient light.

- **Day mode**

In day mode, the Network Camera switches on the IR cut filter at all times to block infrared light from reaching the sensor so that the colors will not be distorted.

- **Night mode**

In night mode, the Network Camera switches off the IR cut filter at all times for the sensor to accept infrared light, thus helping to improve low light sensitivity.

- **Synchronize with digital input**

If an external IR device is connected that comes with its own light sensor, you can use a digital input from it to trigger the IR cut filter. Doing so can synchronize the detection of light level between the camera and the external IR device.

- **Schedule mode**

The Network Camera switches between day mode and night mode based on a specified schedule. Enter the start and end time for day mode. Note that the time format is [hh:mm] and is expressed in 24-hour clock time. By default, the start and end time of day mode are set to 07:00 and 18:00.

Day/Night sensitivity

Adjust the IR cut filter's sensitivity to lighting conditions from the Darkest to the Brightest.

Image

Illuminators

The “Illuminators” page refers to the settings related to the infrared (IR) illuminator. In low-light or completely dark environments, these IR illuminators automatically activate to provide the necessary lighting, enabling the camera to capture clear images. This feature is particularly suitable for scenarios requiring surveillance at night or in low-light conditions.

- **Built-in**

VIVOTEK’s network cameras are equipped with built-in infrared (IR) illuminators designed to enhance image quality in nighttime or low-light environments. These built-in IR illuminators provide uniform lighting, ensuring clear images even in panoramic views.



Built-in IR illuminator in night mode

Enabling the built-in IR illuminator in night mode, and the built-in IR illuminator will automatically activate when the camera detects low light conditions and switches to night mode.

Anti-overexposure

Enabling the Anti-Overexposure feature ensures balanced image quality by dynamically adjusting to challenging lighting conditions, preventing overly bright areas from affecting visibility or detail capture in surveillance footage.

Image

- External

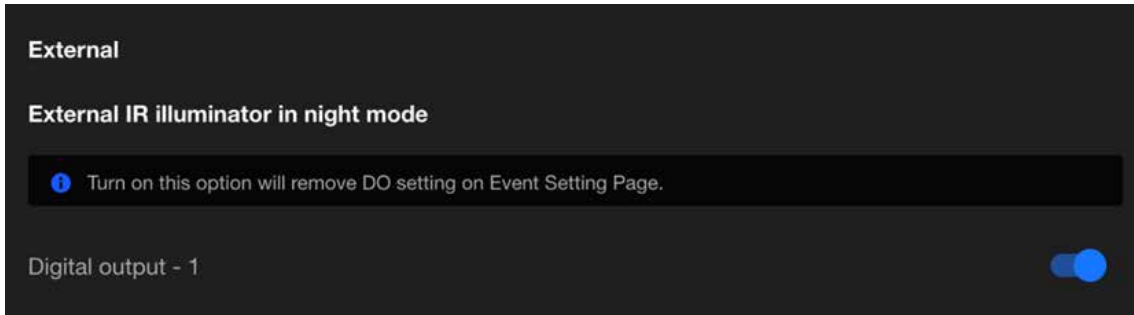

When External IR Illuminator in Night Mode is enabled, the camera will activate the external IR illuminator through Digital Output. External IR illuminators typically offer higher brightness or a wider illumination range, making them ideal for scenarios that require enhanced surveillance performance in low-light environments.

Image

The Image page in the Camera web UI allow users to adjust various parameters to optimize image quality for different environments and applications.

- White balance

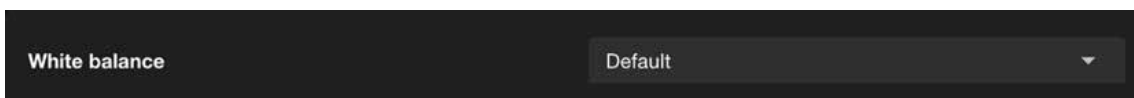

The White Balance setting is crucial for ensuring that colors in the captured video appear natural under different lighting conditions.

Default	<p>In this mode, the camera automatically adjusts the white balance based on the lighting conditions.</p> <p>It is suitable for environments with changing light sources, such as outdoor areas where sunlight and shade vary throughout the day.</p> <p>The camera continuously evaluates the scene and dynamically adapts to ensure accurate color representation.</p>
----------------	--

Image

Fixed current	<p>This mode locks the white balance to the current automatic setting at the moment it is activated.</p> <p>It is useful in environments with consistent lighting, where maintaining a stable white balance is more important than adapting to changes.</p> <p>For example, this mode is ideal for spaces with fixed artificial lighting, such as offices or warehouses.</p>
Manual	<p>This mode allows users to manually set the white balance by adjusting specific parameters like RGain(red) and BGain(blue) levels.</p> <p>It offers the most control and is ideal for scenarios with specialized lighting, such as theatrical productions, where precise color adjustments are required.</p> <p>Users can customize the settings to suit their specific needs and ensure color accuracy in unique lighting conditions.</p>

By selecting the appropriate white balance mode, users can optimize the performance of their VIVOTEK cameras for a variety of environments and use cases.

- **Image adjustment**

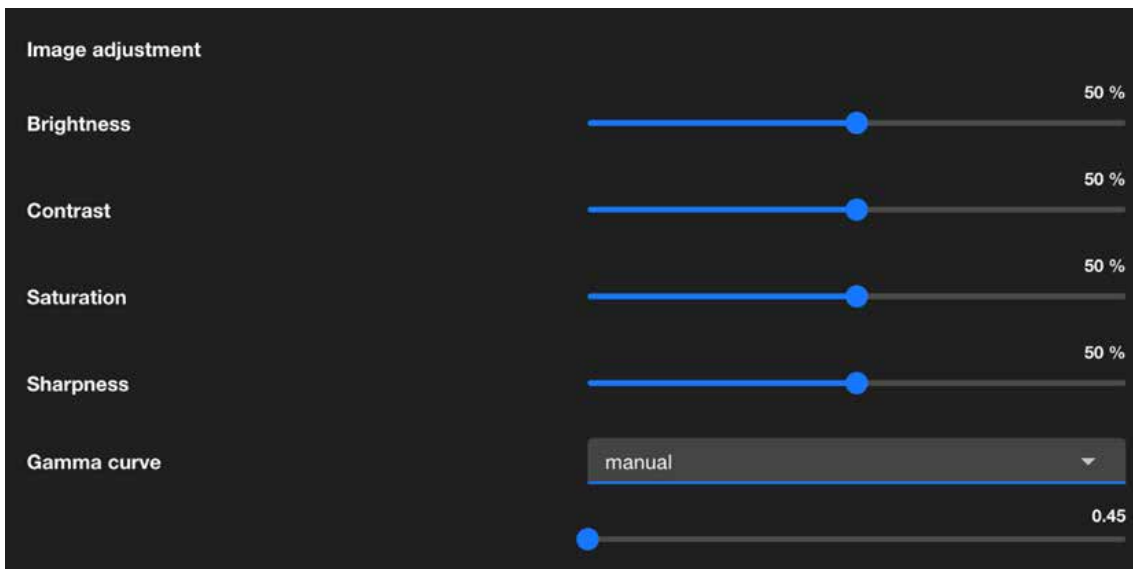

Image

Image Adjustment are essential for fine-tuning the visual quality of the captured images. These adjustments allow users to customize the appearance of the footage to meet their specific needs or adapt to different environmental conditions.

Brightness	<p>Brightness controls the overall lightness or darkness of the image. Increasing brightness makes the entire image appear lighter, while decreasing it makes the image darker.</p> <p>Adjust the brightness to ensure clear visibility in varying light conditions, such as low-light environments or overexposed areas.</p>
Contrast	<p>Contrast determines the difference between the lightest and darkest parts of the image. Higher contrast makes shadows darker and highlights brighter, enhancing the distinction between objects. Lower contrast results in a flatter, less dynamic image.</p> <p>Use contrast to improve image clarity by enhancing the differentiation between objects in the scene.</p>
Saturation	<p>Saturation controls the intensity of colors in the image. Increasing saturation makes colors more vivid and vibrant, while reducing it leads to a more muted or grayscale appearance.</p> <p>Adjust saturation to balance the color intensity for optimal image appearance, especially in scenes with overly vivid or dull colors.</p>
Sharpness	<p>Sharpness determines how clearly the details and edges of objects are defined in the image. Higher sharpness enhances the clarity of edges, but excessive sharpness can cause unnatural outlines or noise.</p> <p>Modify sharpness to emphasize details without introducing artifacts, particularly in scenes requiring precise identification, like license plates or facial features.</p>
Gamma Curve	<p>The gamma curve defines the tonal response of the camera, affecting how brightness levels are distributed. Adjusting gamma alters the mid-tones of the image without significantly affecting the darkest or brightest areas.</p> <p>Use gamma correction to optimize image brightness and contrast for better visual representation under challenging lighting conditions.</p> <p>*This option is disabled when the WDR feature is enabled.</p>

Image

- Defog

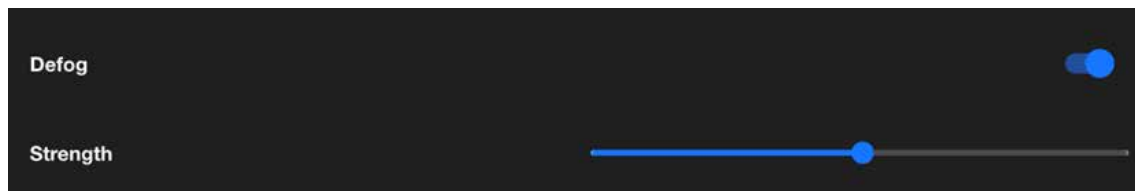

Defog is designed to enhance image clarity in foggy, hazy, or smoggy conditions. It works by adjusting the image's contrast and visibility to reduce the effects of atmospheric conditions that obscure details. This feature is particularly useful in outdoor surveillance environments, ensuring better object recognition and scene visibility despite challenging weather conditions.

- Highlight mask



The Highlight Mask feature displays an overlay on overexposed areas in the video stream, using a mask to make these regions easily identifiable. This allows users to quickly detect and address overexposure issues by visualizing affected areas directly on the video.

Purpose of the feature:

- **Image Quality Optimization**

Helps users fine-tune camera exposure parameters (e.g., brightness, contrast, WDR) to reduce overexposure and improve the visibility of details in the video stream.

- **Adaptability to Various Environments**

Assists in identifying and addressing overexposure in high-brightness environments (e.g., strong light or reflective areas), ensuring usable and clear surveillance footage.

- **Efficiency in Configuration**

Provides immediate visual feedback, simplifying the process of adjusting exposure settings and saving time during setup and testing.

- 3D noise reduction

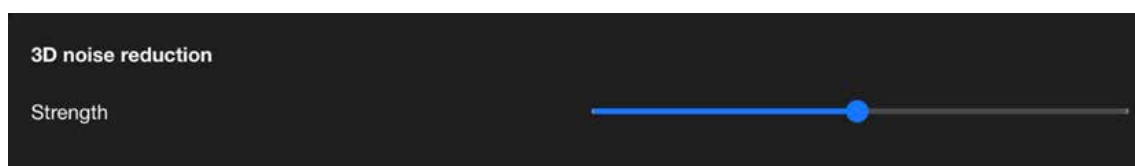

3D noise reduction is primarily used in low-light environments to reduce noise and flicker in the image. You can use the slider to adjust the noise reduction strength. Please note that enabling this feature on the video channel will consume system computing resources. However, when this feature is enabled under low-light conditions with fast-moving objects, afterimage trails may occur. In such cases, you may choose to lower the strength.

Image

- **Electronic image stabilizer**



Electronic Image Stabilizer (EIS) function is designed to reduce image jitter caused by external factors, such as wind, vibrations, or cameras mounted on unstable structures. This feature stabilizes and smoothens the footage by adjusting the image output through software algorithms. Enabling Electronic Image Stabilizer (EIS) in VIVOTEK cameras provides several key benefits:

- **Improves video quality:**

EIS reduces blurriness and jitter caused by vibrations, delivering smoother and clearer video footage.

- **Enhances critical detail readability:**

By stabilizing the image, it becomes easier to identify important details such as license plates, faces, and objects.

- **Optimizes video analytics performance:**

Stability helps reduce false detections, improving the accuracy of analytic features like motion detection and object recognition.

These advantages make EIS an essential feature for maintaining reliable surveillance, especially in environments subject to unavoidable vibrations or movement.

Image

- Integrate image-related settings into a profile

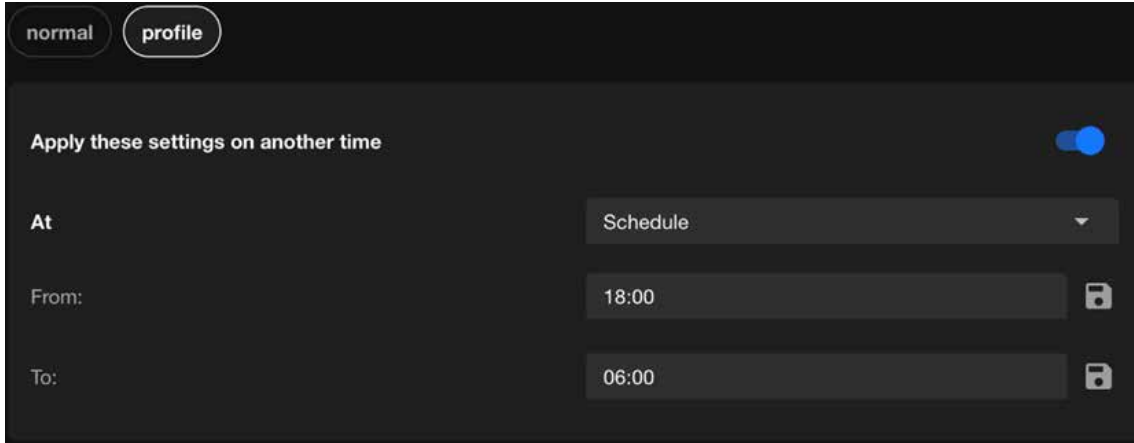

The normal mode in VIVOTEK cameras provides a baseline image configuration ideal for standard monitoring. Through profile mode, specifically **Night** and **Schedule**, users can customize and automate image settings based on specific requirements and time periods. This is **not limited to day-night transitions**, offering greater flexibility and control.

This design delivers:

- Flexible and automated switching of image profiles.
- Optimized image quality for diverse scenarios.
- Improved operational efficiency and resource management.

VIVOTEK cameras ensure consistent performance and high-quality surveillance tailored to various conditions, enhancing both usability and monitoring effectiveness.

The purpose and applications:

Normal	Provides standard image settings for general use	Suitable for daytime or consistent lighting environments
Night (Profile)	Optimizes image settings for low-light or nighttime conditions	Enhances clarity and detail, ideal for night surveillance
Schedule (Profile)	Automatically switches image settings based on custom-defined time	Applies specific settings during designated periods; not limited to day/night transitions

Image

Exposure

The Image page in the Camera web UI control how much light the camera's sensor receives to create a well-balanced image. Proper exposure ensures that the image is neither too bright (overexposed) nor too dark (underexposed), allowing for clear visibility of objects in various lighting conditions.

- **Exposure window**

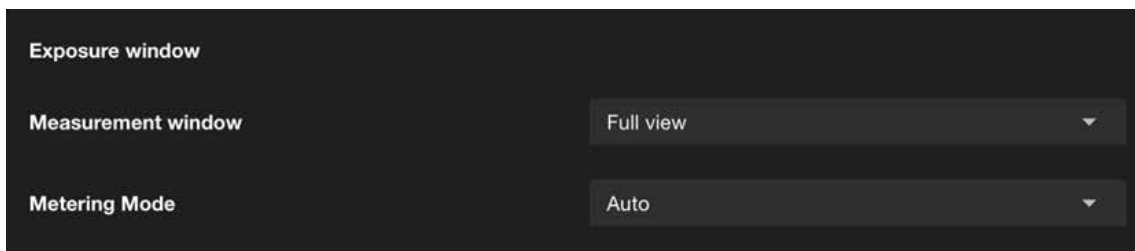

Exposure Window is a feature that allows users to define a specific area within the camera's field of view to optimize exposure settings. By focusing on this designated area, the camera can adjust its exposure parameters to ensure that the area is properly illuminated, even in challenging lighting conditions. This feature is particularly useful in scenarios where different areas of the scene have uneven light levels, enabling the camera to prioritize exposure for critical regions and enhance overall image quality.

Measurement window

This function allows users to set measurement window(s) for low-light compensation. For example, when low-light objects are positioned against an extremely bright background, user may want to exclude the bright sunlight shining through a building's corridor. The types of measurement windows are as follows:

Full view	This option calculates the exposure based on the entire field of view, ensuring that the camera considers all areas within the frame for exposure adjustments.
Custom	This option allows users to manually define specific regions within the frame for exposure measurement. By selecting this setting, users can draw one or more measurement windows on the image, enabling precise control over which areas the camera should prioritize for exposure adjustments.
Center	When selected, the camera focuses on the central portion of the image to determine exposure settings. This is beneficial when the main subject is located in the center of the frame, allowing for optimal exposure in that area.

Image

When users select the Custom mode to use the measurement window, they can define the inclusive window and exclusive window by themselves.

Inclusive windows	Referred to as “weighted windows.” These are given higher priority in the calculation process. Their values are included in the final computation, unless affected by overlapping exclusive windows.
Exclusive windows	Referred to as “ignored windows.” Their role is to exclude portions of the inclusive windows when they overlap. They effectively reduce the contribution of the overlapping inclusive windows.

When an exclusive window overlaps with a larger inclusive window, the exclusive portion is deducted from the inclusive window. This ensures that only the remaining portion of the inclusive window contributes to the calculation. After adjusting for the overlaps between inclusive and exclusive windows, the system calculates the exposure value based on the remaining portion of the inclusive window using the weighted averages method.

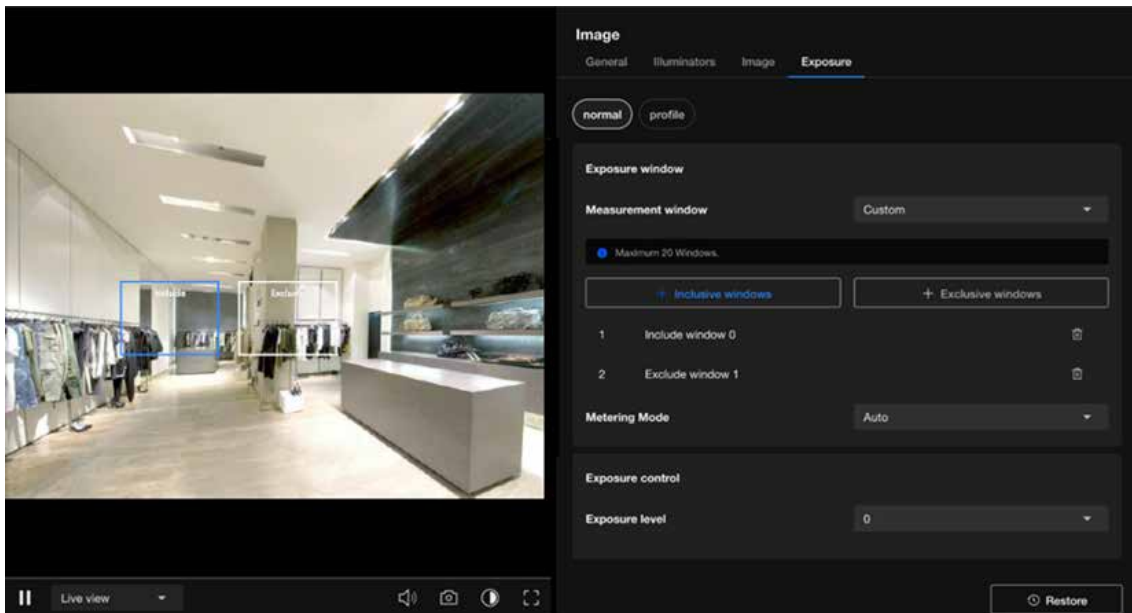

Metering Mode

Metering Mode determine how the camera adjusts its exposure settings in response to different lighting conditions:

Image

Auto	General purpose, when the scene lighting is balanced.	<p>The camera automatically evaluates the entire scene to balance the exposure.</p> <p>It ensures that the overall brightness is optimized for typical scenarios.</p> <p>Suitable for environments with relatively uniform lighting where no extreme light sources dominate.</p>
BLC (Back Light Compensation)	When the subject is in front of a bright light source.	<p>Adjusts the exposure to address situations where the background is much brighter than the subject (e.g., a person standing in front of a bright window).</p> <p>Ensures that the main subject is clearly visible and not underexposed, even if the background becomes overexposed.</p> <p>Ideal for scenes with strong backlighting.</p>
HLC (High Light Compensation)	To manage overexposed bright spots and ensure other areas are visible.	<p>Focuses on reducing the impact of overly bright light sources in the scene, such as headlights, streetlights, or other intense light sources.</p> <p>Darkens overexposed areas (like light spots) to enhance overall image quality while preserving detail in darker regions.</p> <p>Commonly used in nighttime or high-contrast environments where bright highlights can obscure important details.</p>

These settings help optimize the camera's performance for various lighting conditions, ensuring that critical details are captured effectively.

Image

- Exposure control

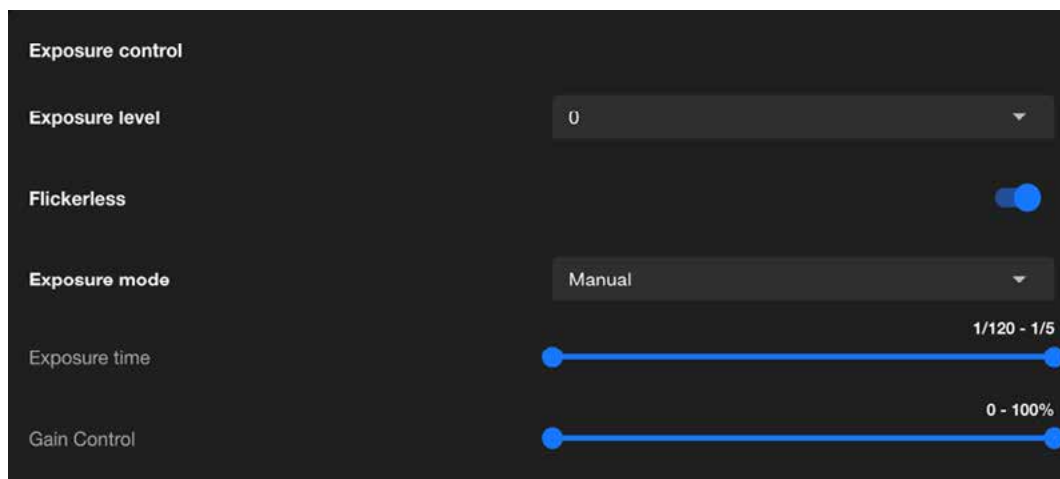

Exposure Control allows users to adjust the camera's exposure parameters based on different environmental conditions to ensure optimal image quality. This function includes Exposure Mode, Iris Control (Iris Mode/Iris Adjustment), Shutter Speed, and Gain Control, making it adaptable to various surveillance needs.

Exposure level

Exposure Level is an additional parameter that fine-tunes the overall brightness of the image.

Increasing the Exposure Level to Brightens the image.

Decreasing the Exposure Level to Darkens the image.

This adjustment is useful for fine-tuning image brightness without manually adjusting shutter speed, iris, or gain settings, making it a quick way to balance exposure across different lighting conditions.

Flickerless

When the Flickerless is enabled, the camera automatically adjusts its shutter speed to synchronize with the flicker frequency of ambient light sources, such as fluorescent or LED lights. This effectively eliminates flickering stripes or flicker effects in the image, ensuring its stability and clarity.

Exposure mode

Exposure mode is used to control how the camera adjusts image exposure parameters (such as Exposure time and Gain Control) to adapt to different ambient lighting conditions. Once the Exposure mode is enabled and configured, it helps the camera automatically or manually adjust the exposure according to scene requirements, ensuring that the image brightness and details meet the desired standards.

Exposure time

Exposure Time refers to the duration for which the camera's sensor is exposed to light, typically expressed in seconds or fractions of a second. The primary purpose of this feature is to control the brightness and clarity of the image, especially under varying lighting conditions.

Gain control

Gain Control is used to adjust the sensitivity of the camera's sensor to light. Gain settings are primarily used to enhance image brightness in low-light environments, though they may increase image noise. This feature helps the camera produce clear and visible images in low-light or high-contrast scenes.

Image

- Image unblur



Image Unblur is a feature designed specifically for dynamic scenes, effectively reducing motion-induced image blur to ensure clear images of fast-moving objects. By adjusting shutter speed and other exposure parameters, this feature is ideal for scenarios requiring high-resolution dynamic recording, such as crowd surveillance. However, reasonable adjustments between brightness and image quality are necessary to achieve optimal results.

Image sharpener with auto shutter speed control

Combining Image sharpener with auto shutter speed control can effectively achieve image unblur. By shortening the shutter speed to reduce blur and applying image sharpening techniques to enhance details, the camera can deliver clear images in dynamic scenes while automatically adjusting other parameters to balance brightness, meeting diverse surveillance needs.

- AE speed adjustment



AE Speed Adjustment controls the response speed of auto exposure to changes in lighting, balancing the immediacy and stability of the image. Its purpose is to provide optimal image quality in different scenarios, avoiding exposure instability or image flickering caused by lighting variations. By flexibly adjusting the AE Speed, diverse surveillance needs can be met, ensuring clear and stable images.

Image

Speed level

The speed level of AE Speed Adjustment should be configured based on the frequency of lighting changes in the surveillance scene. A **slower** speed is recommended for stable scenes, while a **faster** speed is suitable for dynamic scenes, ensuring that brightness adjustments are both smooth and responsive. Through testing and fine-tuning, an optimal balance between image stability and clarity can be achieved.

Sensitivity

Adjusting the sensitivity in AE Speed Adjustment controls the camera's ability to perceive changes in lighting. **Low** sensitivity is suitable for stable scenes, ensuring a steady image, while **high** sensitivity is ideal for rapidly changing scenes, providing real-time response. By testing and tailoring the sensitivity to the specific scene requirements, the optimal balance between light adaptability and image stability can be achieved.

- WDR

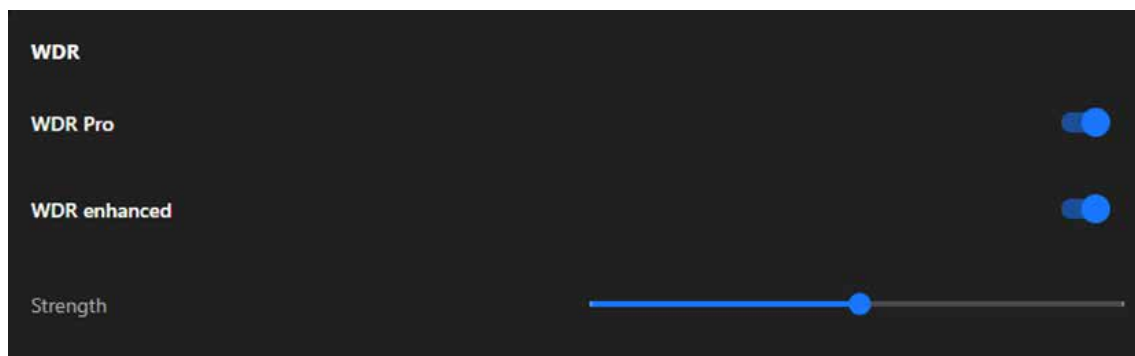

The WDR (Wide Dynamic Range) feature is primarily used to enhance image quality in high-contrast lighting scenarios, balancing the brightness of light and dark areas, preserving details, and ensuring clear visibility. This feature is crucial for scenarios requiring precise monitoring under diverse lighting conditions, such as entrances, tunnels, banks, or nighttime surveillance.

WDR Pro

WDR Pro is an advanced wide dynamic range feature provided by VIVOTEK cameras, offering exceptional image processing capabilities for high-contrast lighting scenarios. It effectively balances details and colors in both bright and dark areas, ensuring overall image quality, making it an ideal choice for scenarios demanding high standards in image detail and lighting management.

Image

WDR enhanced

WDR enhanced is VIVOTEK's most advanced dynamic range technology for high-contrast scenes, offering superior detail restoration in bright and dark areas compared to standard WDR and WDR Pro. It is suitable for scenarios with extreme light contrasts and rapid changes, significantly enhancing image clarity and stability, making it particularly ideal for surveillance applications requiring high detail fidelity.

- Integrate exposure-related settings into a profile

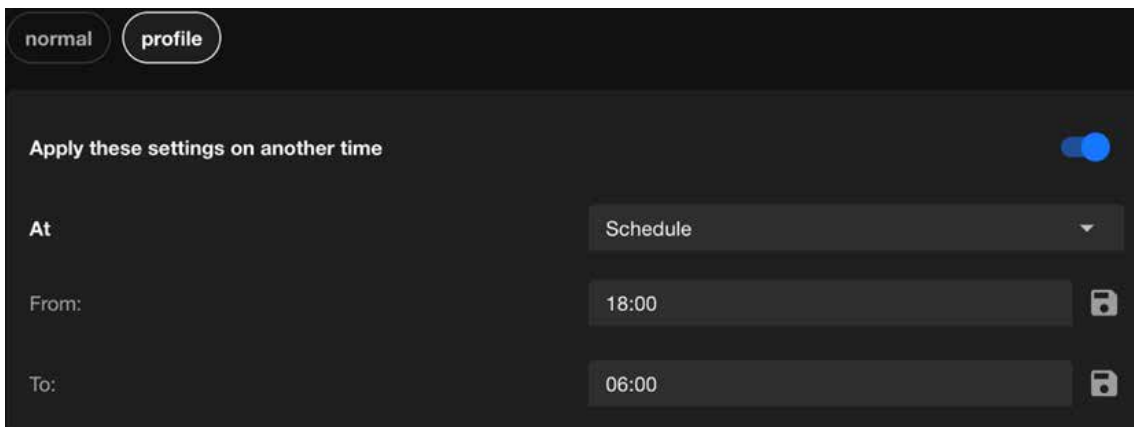

The Exposure settings in VIVOTEK cameras can be finely tuned using the Profile function, allowing automated adjustments based on time (Schedule) or lighting conditions (Night/Normal). This ensures the camera consistently delivers optimal image quality across varying lighting environments.

The purpose and applications:

Normal	Provides default exposure for general use	Shutter speed, gain, and exposure compensation under normal conditions.	Ideal for daytime or consistent lighting conditions
Night (Profile)	Optimizes exposure for low-light conditions	Lower shutter speed, increased gain, balanced exposure	Enhances visibility in nighttime or dark environments
Schedule (Profile)	Time-based switching of exposure profiles	User-defined exposure settings for specific time periods	Adapts to custom needs beyond day/night transitions

Image

Using Privacy Masking to Safeguard Confidential Information in Images

The primary purpose of setting up a Privacy Mask is to protect privacy, comply with regulatory requirements, and enhance surveillance efficiency. By flexibly applying the privacy masking feature in various scenarios, it not only prevents unnecessary privacy violations but also allows a focus on key surveillance areas, improving overall monitoring effectiveness and compliance.

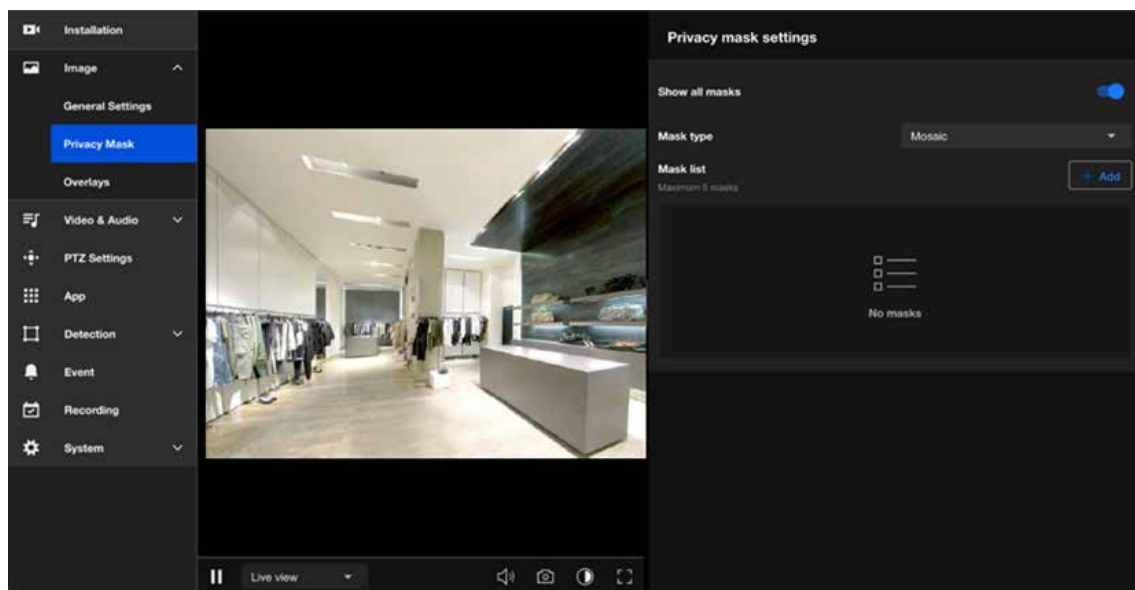

The main benefits of setting up a Privacy Mask are as follows:

- Complies with privacy regulations, reducing legal risks.
- Avoids capturing footage unrelated to surveillance purposes, improving data processing efficiency.
- Reduces privacy intrusion on monitored subjects, enhancing trust and acceptance.
- Keeps the focus on target areas, minimizing distractions and improving surveillance effectiveness.

Image

Privacy mask settings

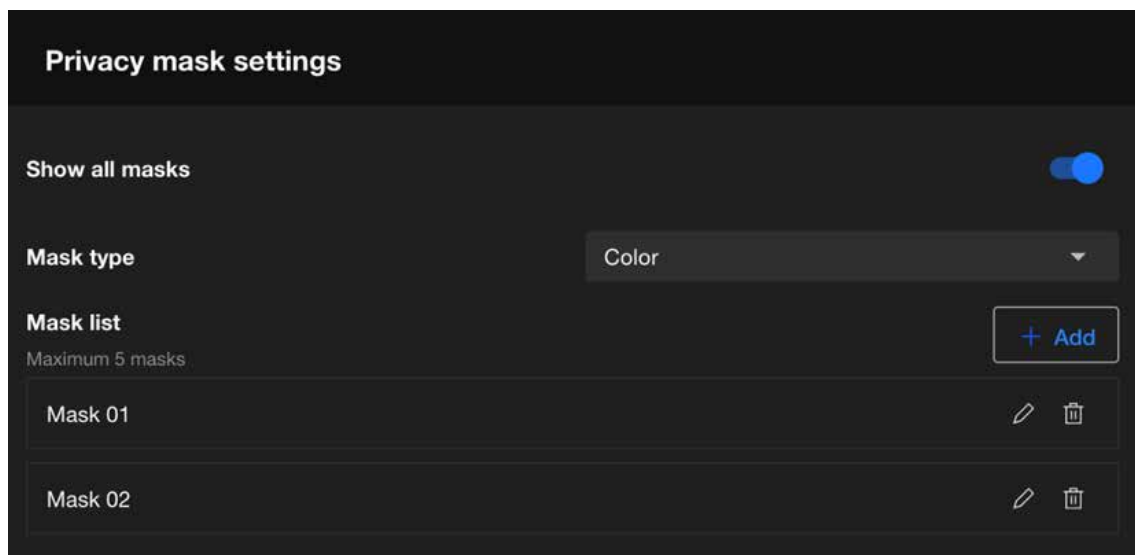

Step to add a privacy mask:

Step 1. Click +Add button in the Mask list.

Step 2. Draw a closed shape to cover the region you want to hide for privacy concerns on the preview screen.

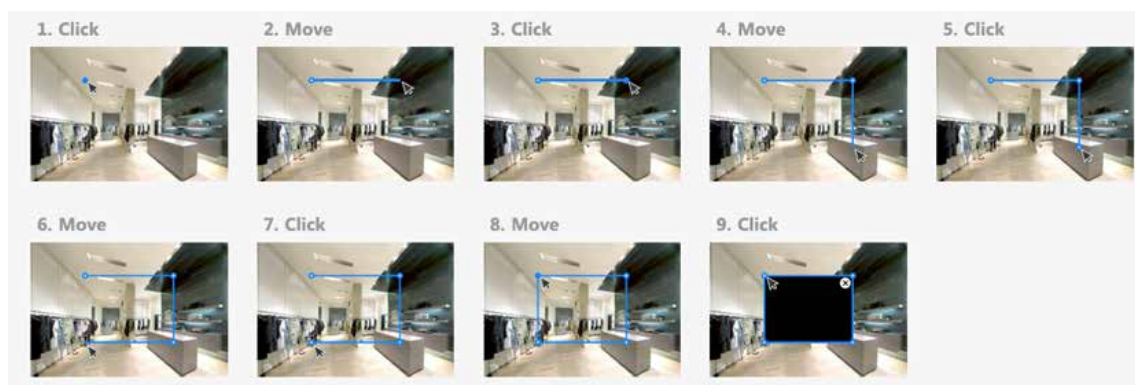

Step 3. Enter the privacy mask name.

Step 4. Click Save button.

Step to delete the privacy mask:

Step 1. Click delete icon on the mask item.

Step 2. The Mask item will be deleted directly.

Image

Step to edit the privacy mask:

Step 1. Click edit icon on the mask item.

Step 2. Drag the mask to the desired Area.

Step 3. Click and drag the corners to adjust the shape (rectangular, trapezoidal, etc.) and size to precisely cover the target area

Step 4. Click Save button.

Show all masks

After the user configures the privacy masks, the “Show all masks” must be enabled to apply the configured masks to the image.

Mask type

Privacy mask offers two types, Color (color masking) and Mosaic (mosaic masking), to meet privacy protection needs in various scenarios. Color Mask is suitable for cases requiring a high level of privacy and complete concealment, while Mosaic Mask is better for scenarios that need to hide details while maintaining the overall natural appearance of the image. Choosing the appropriate mask type based on specific situations ensures efficient and flexible privacy protection.

Image

Customizing Image Overlays to Add Additional Information

The Overlays feature is a powerful tool that enhances the usability and clarity of video streams or recordings by allowing key information to be superimposed on the video feed.

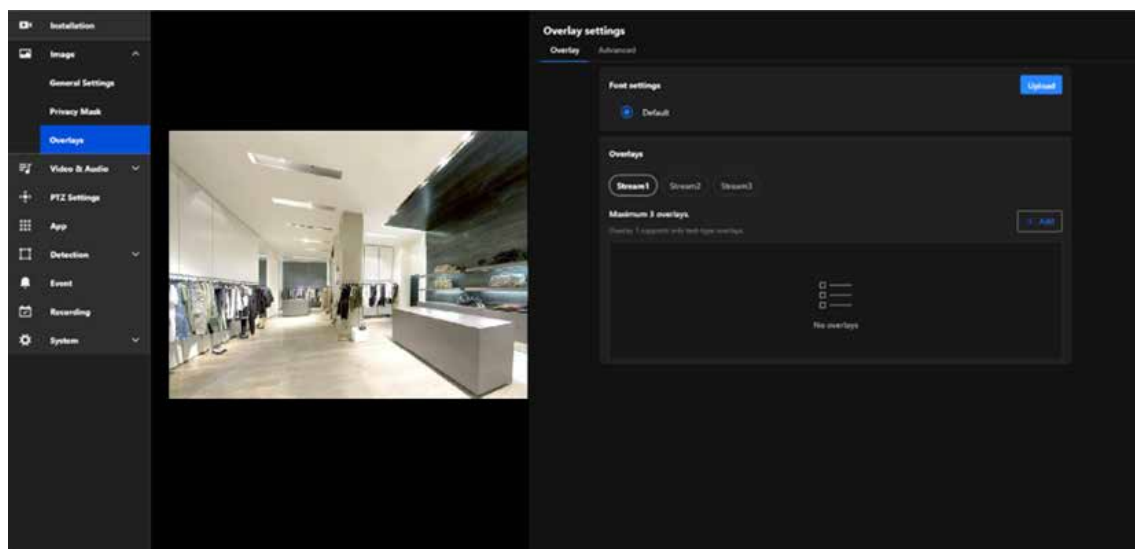

Below is an explanation of its main purposes and functionalities:

- **Displaying Key Information:**
Adds essential details such as the camera name, date and time, location, or custom text to the video, making it easier to identify the source and context of the footage.
- **Enhancing Evidence Validity:**
Timestamp overlays ensure that video recordings can serve as valid evidence for legal or investigative purposes.
- **Branding and Identification:**
Displays logos or other identifiers to reinforce brand recognition, especially useful in commercial or public applications.
- **Real-time Data Monitoring:**
With dynamic text overlay, real-time updates (e.g., sensor data, alarms) can be shown directly on the video feed, making it valuable for environment monitoring or situational awareness.
- **Regulatory Compliance and Alerts:**
Ensures adherence to specific industry or regional regulations by displaying required notifications or warning messages on the video feed.

Image

Overlay

The Overlay allows users to add information to images, such as camera names and timestamps. This information is directly displayed on recorded or live-streamed footage, facilitating future review and management. For instance, by enabling the overlay function, you can display the camera's name and the recording time on the footage, which is highly beneficial for surveillance system management and event tracing.

- **Font settings**

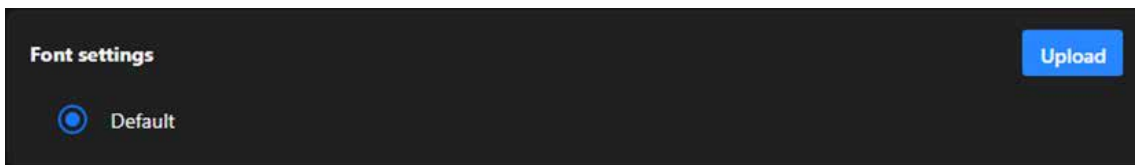

The Font Settings in the Overlay settings allow users to customize the appearance of text overlays on video feeds. This feature ensures that the displayed information is clear, visible, and matches the specific requirements of different monitoring environments.

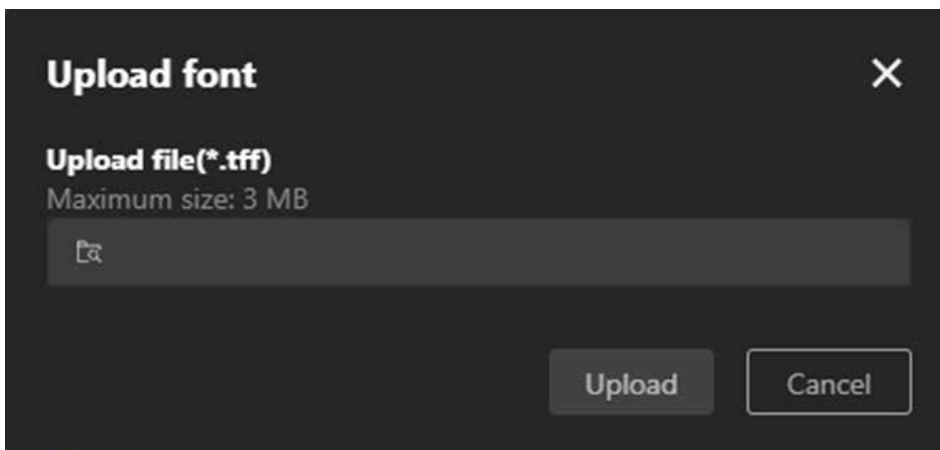

- **Overlays**

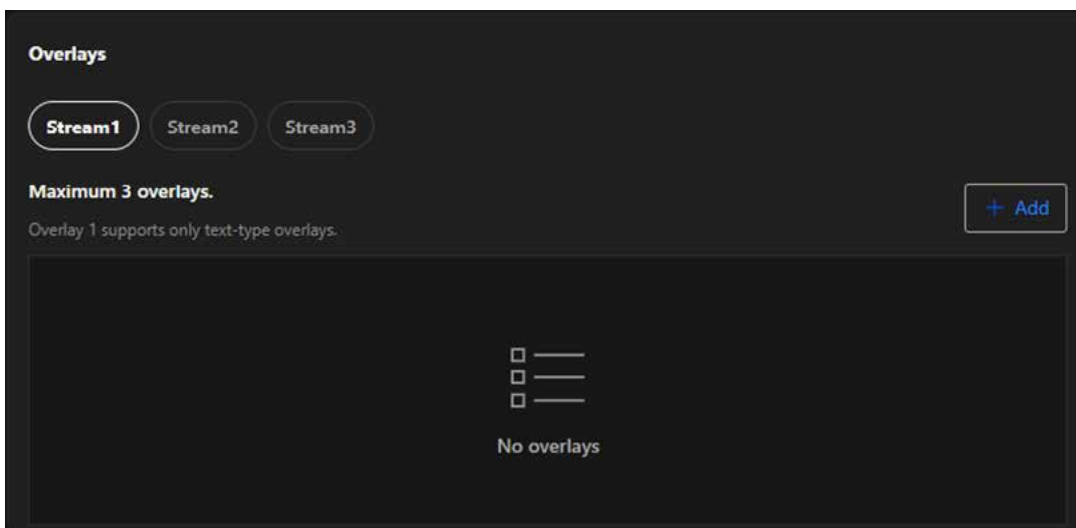

Image

Step to set a overlay:

Step 1. Select the stream (e.g., Stream 1, Stream 2, or Stream 3) you wish to configure for overlay.

Step 2. Click the Add button to create a new overlay.

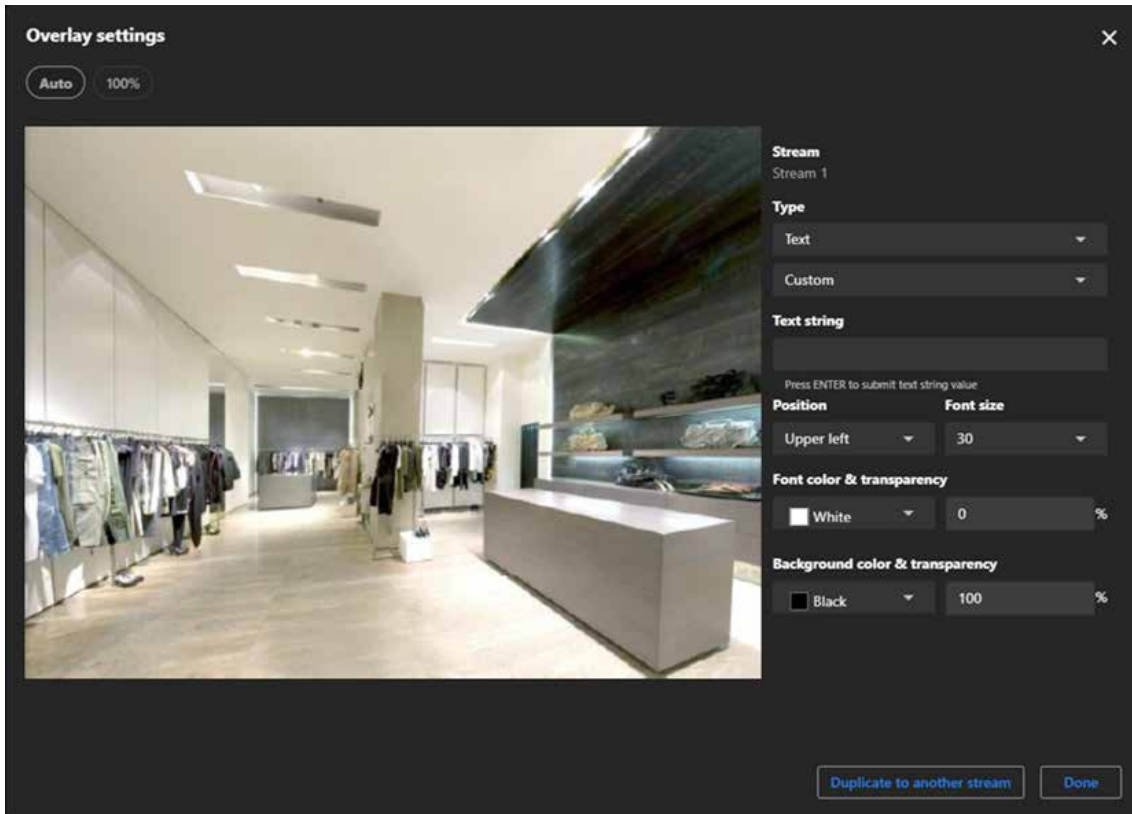

Step 3. Choose the type of overlay:

Text	Date and Time	The display can show the user-defined date and time format.
	Date	The display can show the user-defined date format.
	Time	The display can show the user-defined time format.
	Custom	The display can show user-defined text content.
Image		The display can show 256-color BMP images uploaded by the user.

Image

Live streaming indicator		The Live streaming indicator is a feature within the Overlay settings that visually indicates when the camera is actively streaming live video.
---------------------------------	--	---

Step 4. Click the Position dropdown menu to place the overlay (e.g., Upper Left, Bottom Right). Adjust positioning manually if advanced controls are available.

Step 5. If you select Text, Click the Font size dropdown menu to adjust the text size.

Step 6. If you select Text, please click and configure the Font and Background dropdown menus to choose the appropriate color and transparency.

Step 7. If you select Image, please click and configure the Image transparency dropdown menus to choose the appropriate transparency.

Note:

For image overlays, ensure the size and resolution fit the video stream properly.

Advanced

The Advanced page in the Overlay settings primarily offers advanced features, enabling users to customize overlay content on surveillance footage according to specific requirements. Particularly useful for displaying real-time dynamic data or in professional scenarios, this settings page provides the necessary flexibility and functional support.

- **Dynamic Text Overlay**

Dynamic Text Overlay is an advanced feature of VIVOTEK cameras that allows users to display real-time dynamic information from external data sources on surveillance footage. This feature enhances the practicality and informational value of the footage, making it suitable for various surveillance scenarios.

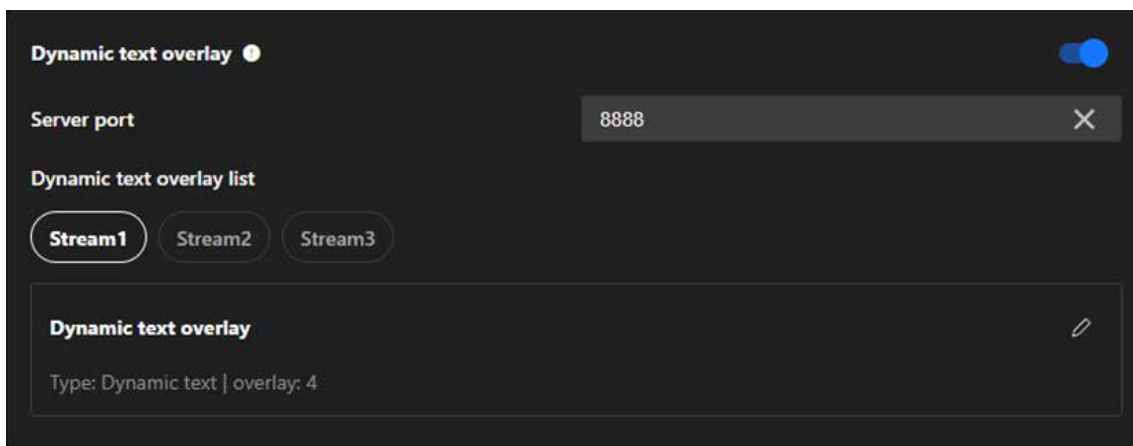

Image

Step to set the dynamic text overlay:

Step 1. Enable Dynamic text overlay

Step 2. Ensure the Server Port is set to an available port (default: 8888) or specify another unused port if necessary.

Step 3. Ensure your external data source is configured to send data to the camera's IP address and the specified server port (e.g., 8888).

Step 4. Ensure the data format is compatible with the camera's requirements.

Step 5. Select the stream you want to add the dynamic text overlay to.

Step 6. In the "Dynamic Text Overlay List," click the Edit (pencil icon) to configure overlay details.

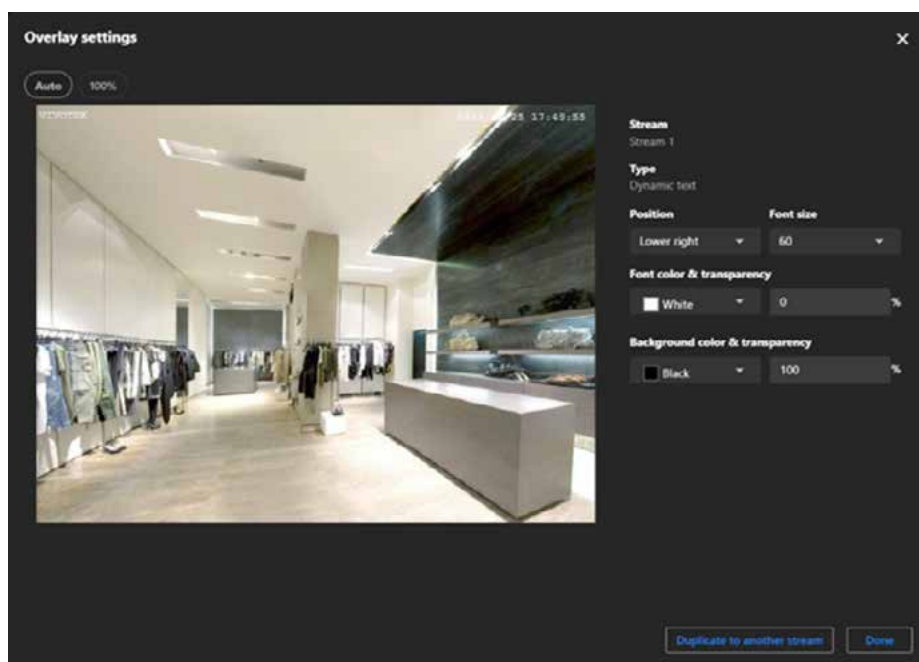

Video & Audio

The main purpose of Video & Audio settings is to ensure high-quality video and audio by adjusting resolution, frame rate, and compression formats, while optimizing bandwidth and storage usage with multi-stream options. These settings enhance monitoring capabilities with high resolution, smooth frame rates, and two-way audio, and provide adaptability for various scenarios such as night mode or outdoor environments. Additionally, they improve system flexibility and compatibility by supporting multiple media formats and protocols for seamless integration across devices.

Optimizing Surveillance Efficiency with Flexible Video Settings

The Video settings are divided into the Mode page and the Stream page, both primarily used for configuring the camera's video output, offering users flexible control over video quality and resource management.

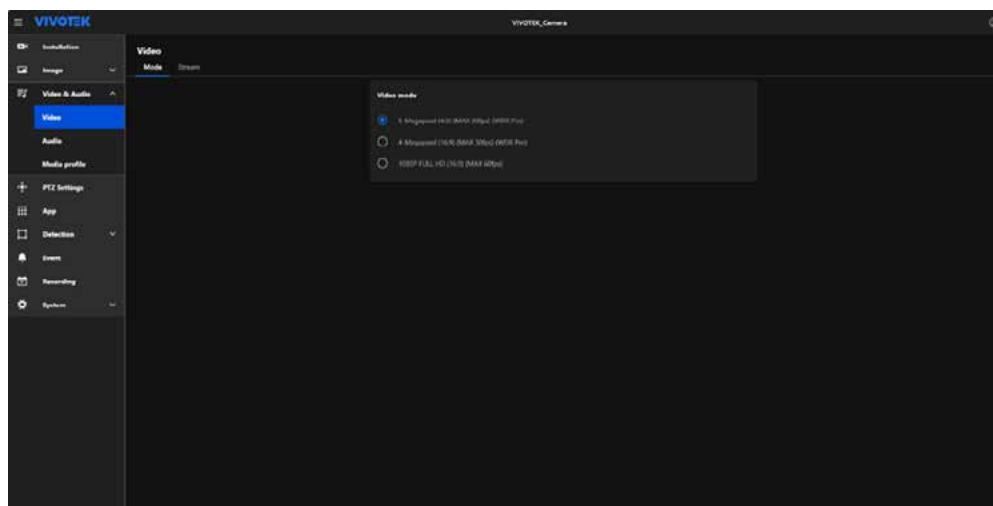

• Video mode

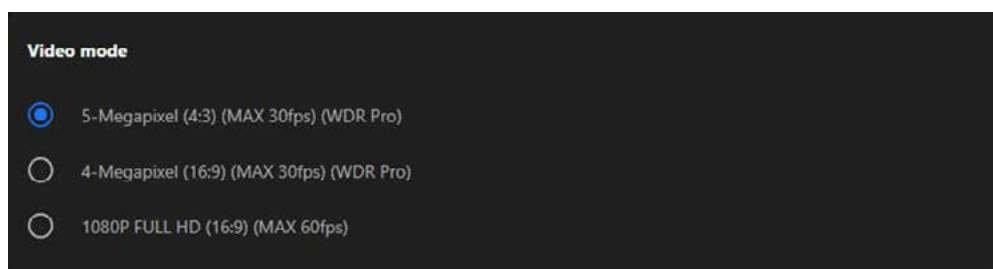

Video mode allows users to customize the camera's video performance to meet specific monitoring needs while achieving a balance between high-quality video output and resource efficiency. The main features are as follows:

Defines Video Resolution

The Video Mode determines the maximum resolution the camera can output, such as **4K Ultra HD**, Full HD, or other resolutions, ensuring high-quality video feeds.

Video & Audio

Sets Aspect Ratio

Configures the aspect ratio of the video (e.g., 16:9), optimizing the field of view for modern widescreen displays.

Controls Frame Rate

Specifies the maximum frames per second (fps), such as 30fps, for smooth motion capture in dynamic environments.

Establishes Video Parameters

Sets the overall video performance limits, including resolution and frame rate, which affect the clarity, smoothness, and resource usage of the video stream.

• Video stream

Video Stream is designed to offer flexible video output options to meet diverse surveillance needs while optimizing bandwidth and storage resource usage. Through multi-stream configuration, intelligent compression technology, and regional optimization, Video Stream serves as a key tool for enhancing surveillance efficiency and adaptability across various applications.

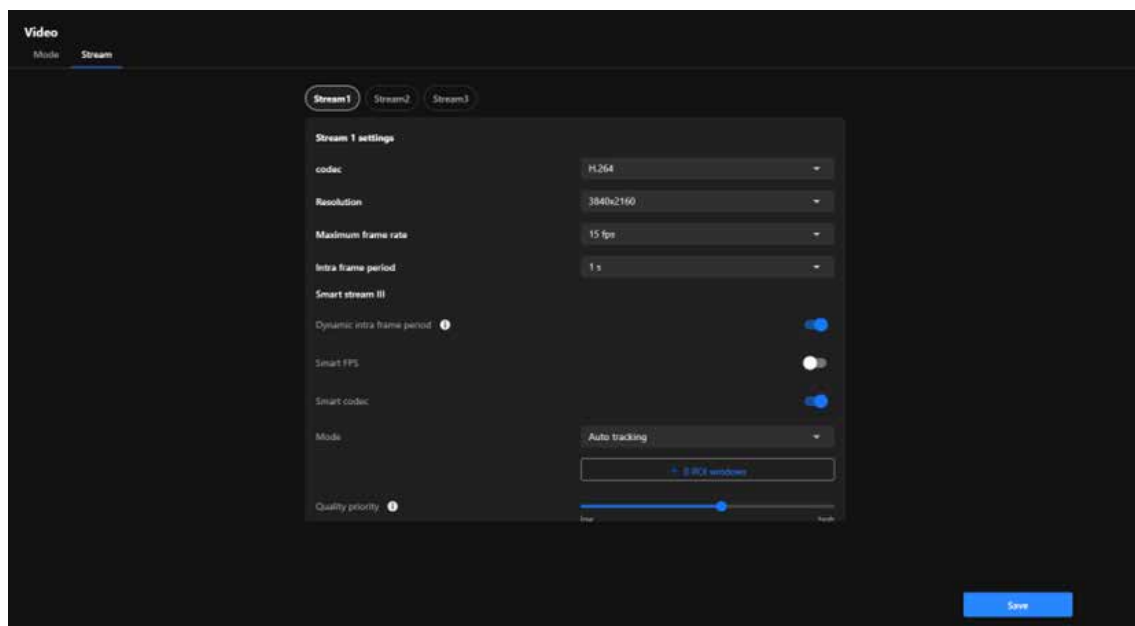

Codec

Defines the video compression format.

MJPEG	High quality and clarity needed, sufficient bandwidth available.
H.264	Dynamic scenes with stable bandwidth.
H.265	High resolution or bandwidth-limited environments.

Video & Audio

Resolution

Resolution is a key parameter of image quality, directly affecting the clarity of surveillance footage, storage requirements, and bandwidth usage. Choosing the appropriate resolution requires considering the monitoring purpose, scenario needs, and resource constraints.

Maximum frame rate

Maximum frame rate is a parameter that determines the number of video frames captured and transmitted by a camera per second. Frame rate affects the smoothness of the video, detail capture, bandwidth usage, and storage requirements. Choosing an appropriate frame rate requires considering the monitoring scenario, purpose, and system resources. Recommended frame rate settings as:

High-Speed Motion (e.g., Traffic, Sports)	30fps or higher	Smoothly captures fast-moving scenes, suitable for scenarios requiring clear observation of moving objects.
General Surveillance (e.g., Stores, Offices)	15fps	Balances video smoothness and bandwidth usage, ideal for most everyday monitoring needs.
Static Scenarios (e.g., Warehouses, Parking Lots)	10fps or lower	Saves resources, suitable for scenarios emphasizing static environments.
Low-Bandwidth Environments or Remote Monitoring	5fps	Reduces bandwidth usage, ideal for situations with network constraints or basic monitoring requirements.

Video & Audio

Intra frame period

Intra Frame Period determine how often for firmware to plant an Intra frame (I-frame). The shorter the duration, the more likely user will get better video quality, but at the cost of higher network bandwidth consumption. Recommended settings based on use cases:

High-Dynamic Scenarios (e.g., Traffic Monitoring)	1 second	Quickly generates complete frames, suitable for capturing fast-moving targets.
General Surveillance (e.g., Offices, Stores)	2 seconds	Balances video clarity, bandwidth, and storage usage, ideal for most daily surveillance scenarios.
Static Scenarios (e.g., Warehouses)	3 seconds or longer	Reduces the number of I-Frames to save resources, suitable for low-variation scenes.
Remote or Low-Bandwidth Monitoring	1-2 seconds	Prevents image degradation and ensures smoothness and quality in remote viewing.

Smart stream III

Smart Stream III is an advanced video optimization technology in VIVOTEK cameras, focusing on dynamically managing bandwidth and storage usage while maintaining critical details and image quality. This technology effectively reduces bandwidth and storage requirements by intelligently adjusting frame rates, compression ratios, and regional quality, making it particularly suitable for scenarios with limited bandwidth or requiring long-term recording. The configuration items for Smart Stream III are as follows:

- **Dynamic intra frame period**

Smart FPS analyzes motion in the scene and optimizes encoding efficiency while maintaining a constant frame rate (FPS). When no motion is detected, it sends identical frames to the encoder, reducing P-frame size due to the lack of differences between consecutive frames. This process minimizes bandwidth and storage usage while ensuring smooth video playback without altering the perceived motion quality.

- **Smart FPS**

Smart FPS analyzes motion in the scene and optimizes encoding efficiency while maintaining a constant frame rate (FPS). When no motion is detected, it sends identical frames to the encoder, reducing P-frame size due to the lack of differences between consecutive frames. This process minimizes bandwidth and storage usage while ensuring smooth video playback without altering the perceived motion quality.

- **Smart codec**

Utilizes advanced compression technology to maintain detail in high-motion areas while heavily compressing static areas. Optimizes bandwidth and storage usage without losing critical information.

Video & Audio

- **Mode**

Defines how the camera manages the ROI (Region of Interest) in the video and optimizes image quality and resource allocation. Mode offers different operating options, allowing users to flexibly choose auto tracking, manual, or hybrid ROI settings based on surveillance needs and scene characteristics.

Auto Tracking	High-dynamic scenarios (e.g., traffic, public spaces) Automated processing, no manual configuration needed Cannot focus on specific static areas
Manual	Static scenarios (e.g., offices, warehouses) Precise control over areas of interest Not suitable for dynamic environments
Hybrid	Mixed dynamic and static scenarios (e.g., retail, entrance monitoring) Balances static and dynamic needs, highly flexible May require additional configuration

How to add the ROI window?

Step 1. Click the + ROI Windows button.

Step 2. Drag and resize the selected areas to adjust ROI areas in the preview screen.

Note:

Multiple ROI areas can be added to target different critical locations, such as entrances, cash registers, or driveways.

Step 3. Click the Save button.

Quality priority

Quality Priority is a parameter used to define the priority of image quality, providing higher or lower image quality for specific ROI areas to balance resource usage and image clarity.

Bit rate control

Bit rate control is used to adjust the transmission bit rate of video, achieving a balance between image quality and bandwidth usage.

Fixed Quality

When the surveillance scenario demands high image quality and network and storage resources are relatively sufficient, it is recommended to use Fixed Quality to ensure that no image details are lost.

Constrained Bit Rate

If the surveillance environment has limited bandwidth or storage resources, it is recommended to choose Constrained Bit Rate to precisely control resource usage by limiting the bit rate.

Video & Audio

Target quality

Target Quality sets the target quality level of the video, instructing the camera on how to compress the video to achieve the desired clarity. The purpose and applications:

Option	Purpose	Effect on Stream	Application
Customized	User-defined quality settings	Manual adjustment for precise stream control	Scenarios requiring tailored stream parameters
Medium	Lower requirements for target quality	Lower quality, reduced bitrate	Low-priority streams or low-bandwidth networks
Standard	Balances quality and efficiency	Moderate quality with controlled bitrate usage	General-purpose monitoring
Good	Enhances stream clarity	Better detail while keeping bitrate reasonable	Busy areas with moderate detail requirements
Detailed	Provides high detail in the video stream	Higher quality, sharper images, increased bitrate	Surveillance requiring detailed object clarity
Excellent	Maximizes stream quality	Highest image clarity and bitrate usage	High-security monitoring, critical evidence recording

Maximum bit rate

Maximum Bit Rate is a feature used to limit the bit rate of the camera's video stream, aiming to control bandwidth and storage resource usage while maintaining video quality. Properly configuring the Maximum Bit Rate not only ensures stable system operation but also effectively optimizes resource allocation, making it an essential tool in multi-camera systems and low-bandwidth environments.

Policy

The function and purpose of the policy are to achieve flexibility and specificity in video transmission, balancing frame rate and image quality according to scenario requirements, thereby enhancing the effectiveness, stability, and resource utilization efficiency of the monitoring system.

Video & Audio

Frame Rate Priority	Suitable for dynamic monitoring scenarios, ensuring smooth video playback to facilitate real-time monitoring and quick response.
Image Quality Priority	Suitable for static or detail-demanding scenarios, providing higher image clarity to record critical details effectively.

Smart Q

Smart Q is an intelligent image management feature designed to dynamically balance image quality and resource utilization efficiency. It not only enhances the effectiveness of surveillance footage but also improves the utilization of bandwidth and storage resources. This is particularly suitable for scenarios requiring long-term recording, attention to detail, or resource-constrained monitoring systems.

Video & Audio

Configuring Audio Settings for Enhanced Input and Output Performance

The overall functionality of this page is designed for comprehensive management of the camera's audio features, covering everything from real-time audio input and output to managing audio clip playback.

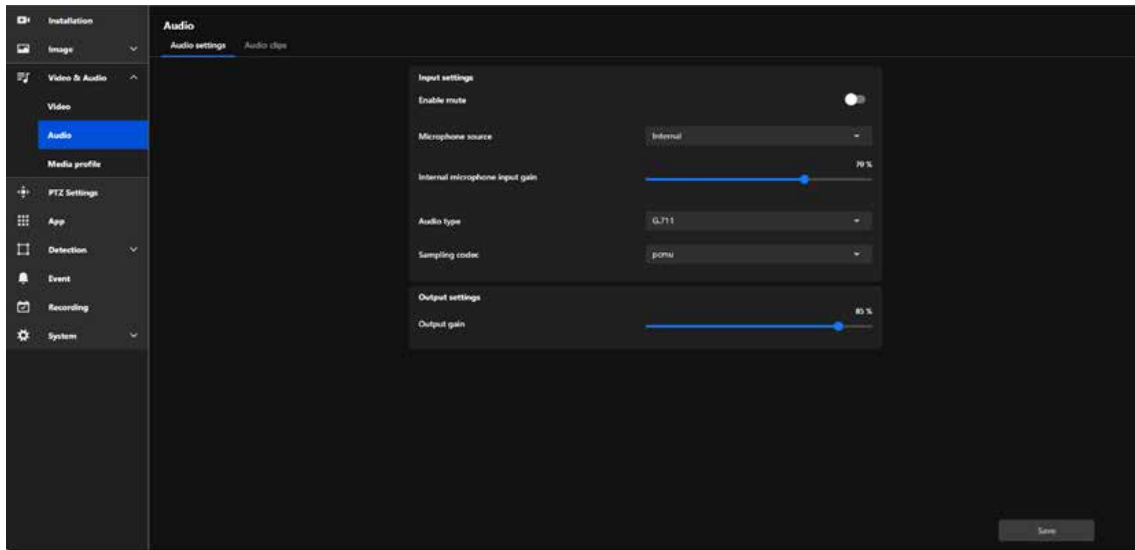

Its purposes include:

- Enhancing overall surveillance effectiveness by leveraging audio to support video for more efficient security monitoring.
- Improving communication and incident response capabilities by integrating two-way communication and alarm features to meet diverse situational needs.
- Providing flexible control and management tools, enabling easy configuration for both real-time audio processing and pre-recorded audio playback.

These features make the application of audio in surveillance environments more flexible and efficient.

Audio settings

The purpose of this setting is to provide detailed configurations for audio input and output, optimizing the audio functionality of surveillance cameras and allowing users to adjust audio quality, volume, and source based on their specific needs.

Video & Audio

- **Input settings**

The purpose of this setting is to provide detailed configurations for audio input and output, optimizing the audio functionality of surveillance cameras and allowing users to adjust audio quality, volume, and source based on their specific needs.

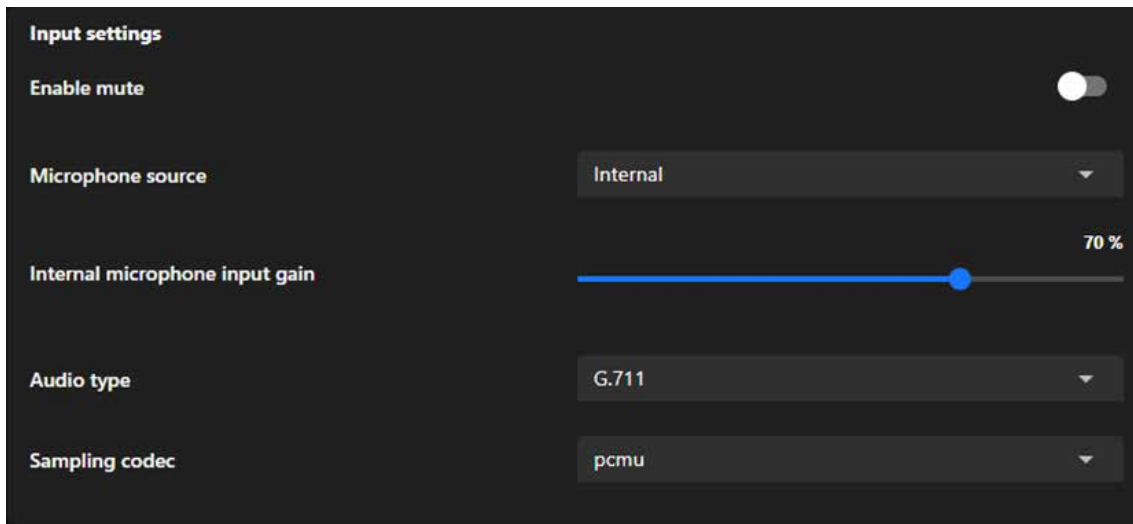

Enable mute

Enable mute allows users to disable audio input, ensuring privacy or preventing unwanted sound recording.

Microphone source

Microphone source lets users select between Internal or External microphones to adapt to different audio capture needs and hardware setups.

Internal/External microphone input gain

Internal/External microphone input gain allows users to adjust the microphone's sensitivity, enhancing or reducing audio capture levels to suit varying environmental noise conditions and ensure clear sound recording.

Audio type

The audio type setting determines the encoding format for audio, balancing quality, bandwidth usage, and compatibility:

AAC

Offers high-quality audio with efficient compression, ideal for environments requiring clear sound with minimal distortion.

AAC Bit Rate

AAC Bit Rate is a sub-setting under Audio Type, which only appears when AAC is selected. It is used to fine-tune the quality and resource usage of AAC audio format, enabling users to optimize the configuration based on practical scenarios, such as bandwidth or storage requirements.

Video & Audio

G.711

A widely used codec for real-time communication, providing good audio quality with low compression, suitable for networks with sufficient bandwidth.

Sampling codec

Defines the compression method for the selected audio type (typically G.711), affecting audio quality and compatibility:

pcmu	Commonly used in North America and Japan, it provides slightly higher audio quality with a focus on maximizing dynamic range for voice clarity.
pcma	Commonly used in Europe and other regions, it delivers comparable quality to pcmu but is optimized for different telecommunication standards.

G.726

Provides moderate compression, balancing quality and bandwidth usage, suitable for environments with bandwidth constraints.

G.726 Bit Rate

G.726 Bit Rate is a specific configuration option that appears based on the selection of Audio Type and is only active when G.726 is chosen. This option allows users to further adjust the encoding bit rate to optimize settings according to practical needs, such as network bandwidth or storage space limitations.

- **Output settings**

Users can manually adjust the audio output volume to suit different application environments.

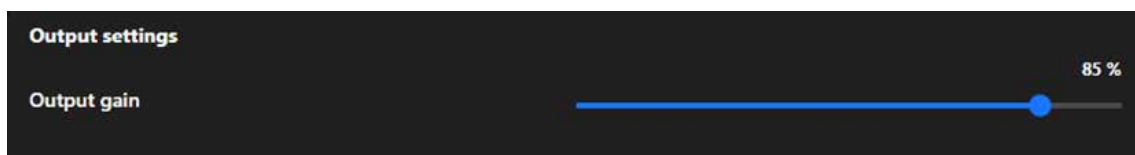

Output gain

Users can manually adjust the audio output volume to suit different application environments:

In scenarios requiring high volume (such as alarms or wide-area broadcasts), gain can be increased to enhance the volume.

In scenarios requiring lower volume (such as privacy mode or silent operation), gain can be reduced to minimize audio interference.

Video & Audio

Audio clips

The Audio Clips feature is designed to integrate audio with event triggers, enabling more efficient notifications, alerts, and interactions, thereby enhancing the application value of cameras in surveillance and security scenarios.

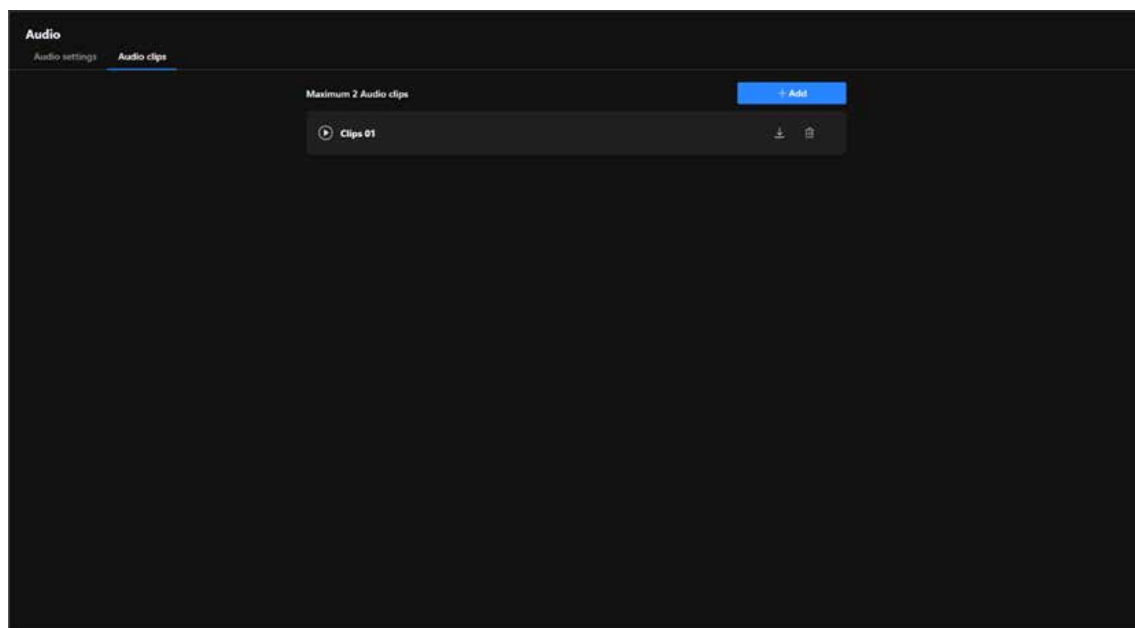

The purpose of the functionality:

Enhance Incident Response Capability

By playing audio alerts or notifications, it can promptly notify nearby personnel of anomalies or potential threats.

Strengthen Security Deterrence

Play pre-recorded warning messages or alarm sounds upon detecting intruders or suspicious activities, effectively deterring potential threats.

Increase Monitoring Flexibility

Support for customizable audio content to cater to various scenarios, such as playing welcome messages in stores or broadcasting regulatory instructions in parking lots.

Simplify Operational Processes

Automated audio playback reduces the need for manual operations, further improving surveillance efficiency.

Video & Audio

Step to add an audio clips:

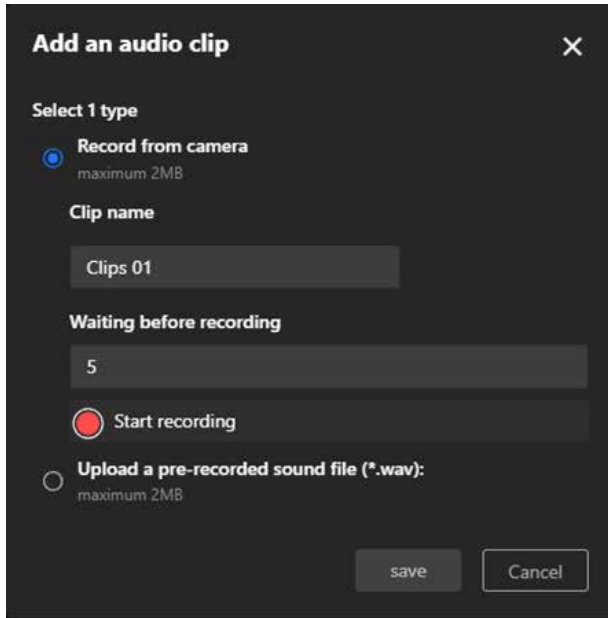

Add an audio clip [X]

Select 1 type

Record from camera
maximum 2MB

Clip name

Clips 01

Waiting before recording

5

Upload a pre-recorded sound file (*.wav):
maximum 2MB

Step 1. Select the one of the two options under “Select 1 type” for the audio source.

Record from camera

Use the camera’s built-in microphone to record audio, with a maximum file size of 2MB.

Upload a pre-recorded sound file

Upload a pre-existing audio file, which must be in .wav format and not exceed 2MB.

Step 2. Enter a name for the audio clip in the “Clip name” field (e.g., “Clips 01”) to identify it later.

Step 3. In the “Waiting before recording” field, input the number of seconds to delay the start of the recording (e.g., 5 seconds) to allow time for preparation before recording begins.

Step 4. Click the red “Start recording” button to initiate a countdown for the specified time, after which the system starts recording audio and automatically saves the recording upon completion for review.

Video & Audio

Configuring Media Profiles to Optimize Video Performance for Versatile Applications

In VIVOTEK cameras, the Media Profile function primarily displays pre-set stream parameters and allows users to enable or disable video, audio, and metadata. This functionality simplifies stream management while providing the flexibility to adapt to various monitoring scenarios, such as recording, live viewing, and mobile access, ensuring efficient and effective surveillance management.

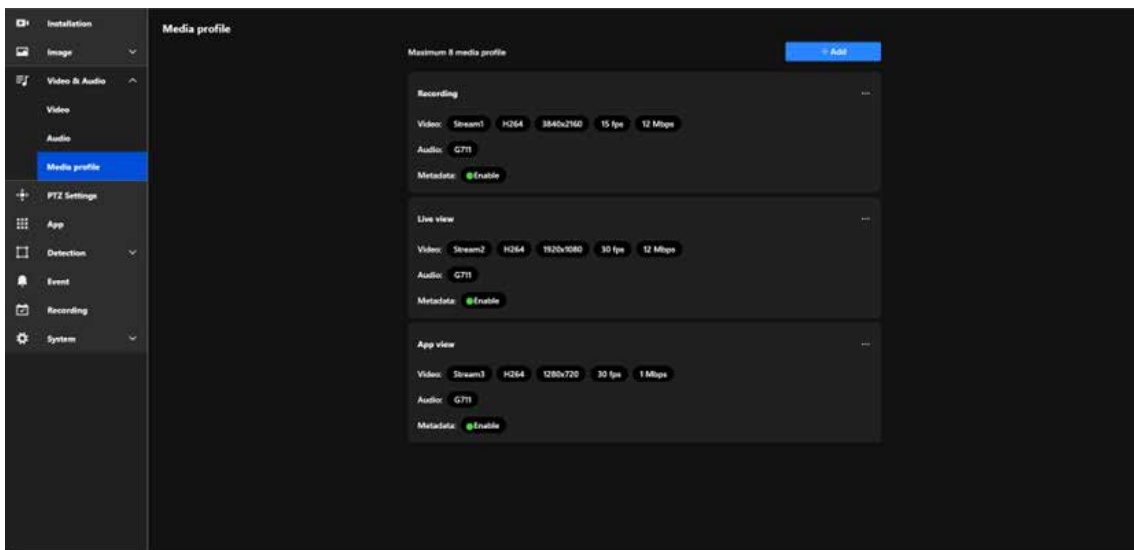

Benefits and Features:

Stream Management Simplified

Users can quickly enable or disable video, audio, and metadata features for each profile.

Clear Stream Display

Media Profile displays the preconfigured stream parameters (e.g., resolution, frame rate, bit rate) for easy identification and management.

Flexible Application Scenarios

Users can create multiple profiles for different needs, such as:

Recording: High-resolution video enabled.

Live View: High frame rate for smooth real-time playback.

App View: Low-resolution video for bandwidth efficiency.

Optimized Resource Management

By enabling or disabling features, users can reduce bandwidth and system resource usage as needed.

Video & Audio

Media profile

The Media profile is designed to display preconfigured stream parameters and allow users to enable or disable specific features, such as:

Video:

Displays the selected stream settings and allows enabling or disabling the video stream.

Audio:

Enables or disables the audio feature and displays the audio codec in use.

Metadata:

Enables or disables metadata functionality, supporting further video analysis and event tagging.

Note:

Media Profile does not allow configuration of video resolution, frame rate, or bit rate. These parameters are pre-set in the Stream settings, and Media Profile only displays the relevant settings and enables feature toggling.

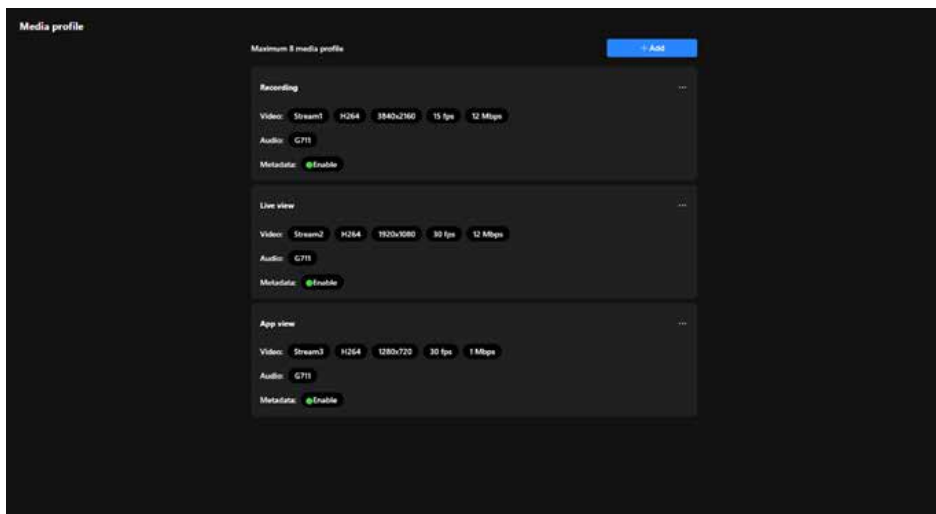

Step to add a Media profile:

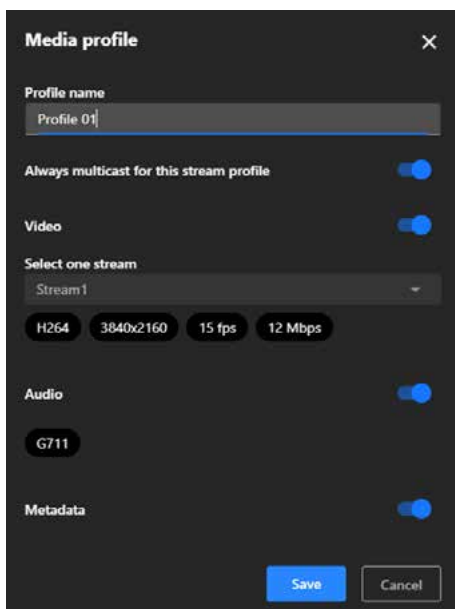

Video & Audio

Step 1. Locate and click the blue “+ Add” button on the Media Profile screen.

Step 2. To enter a profile name in the “Profile Name” field.

Step 3. Enabling the “Always Multicast for this Stream Profile” option allows multiple users to access the same video stream simultaneously.

Note:

This feature is particularly beneficial in scenarios requiring efficient data transmission, such as large-scale surveillance systems. By utilizing multicast, the camera sends a single video stream that can be shared among multiple viewers, significantly reducing network bandwidth consumption compared to unicast streaming, where separate streams are sent to each user.

Step 4. To enable the “Video” option and select a stream in the Video stream settings.

Step 5. To enable the “Audio” option.

Step 6. To enable the “Metadata” option.

PTZ Settings

PTZ Settings is designed to provide users with a convenient interface for efficiently managing and operating PTZ cameras, suitable for real-time adjustments and rapid targeting in surveillance scenarios, enhancing the flexibility and accuracy of surveillance management.

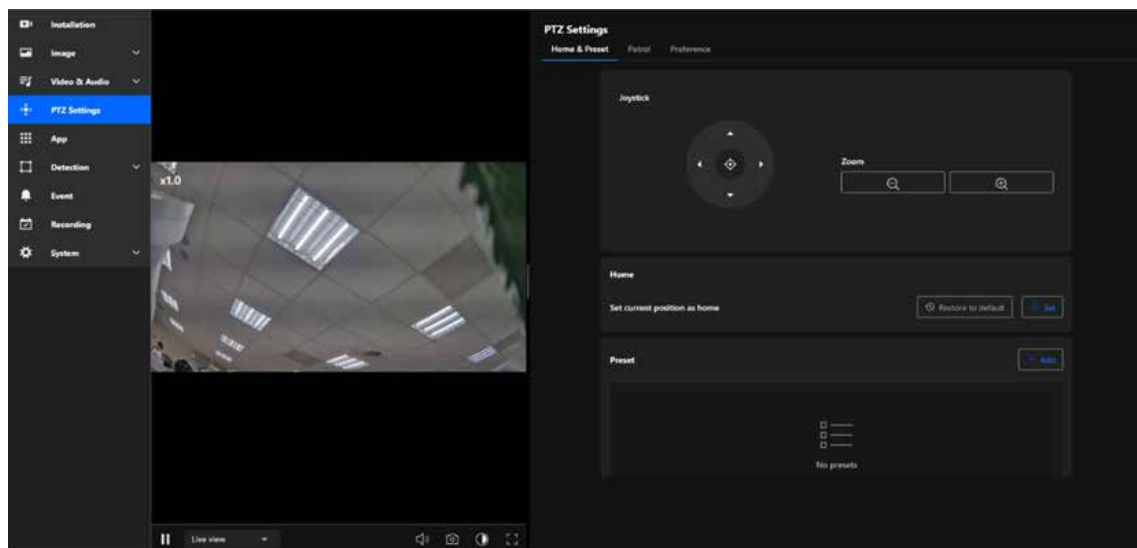

Effortlessly Manage and Customize PTZ Settings for Precise Camera Control

PTZ Settings offers a comprehensive and intuitive set of tools for flexible operation of PTZ cameras, covering real-time adjustments, preset management, and automated patrol. These features effectively enhance surveillance efficiency, enabling users to quickly focus on critical details or meet the requirements of large-scale scene monitoring.

Home & Preset

The purpose of the Home & Preset tab in PTZ Settings is to assist users in configuring and managing the primary viewpoints and preset positions of the camera, enhancing operational efficiency and enabling quick transitions.

The purpose are as follows:

Simplify Camera Operation

By configuring Home and Presets, users can quickly switch to and return to specified positions, reducing the time required for manual adjustments.

Enhance Surveillance Efficiency

Facilitates effective monitoring of multiple key areas, especially in scenarios that require frequent perspective switching.

PTZ Settings

Achieve Flexibility and Precision

Enables users to precisely configure and adjust the camera's viewpoints and focal lengths to meet the demands of various scenarios.

- **Joystick**

The Joystick provides users with precise control over the camera's direction and focus, suitable for real-time operation, ensuring flexibility and accuracy in the monitoring range.

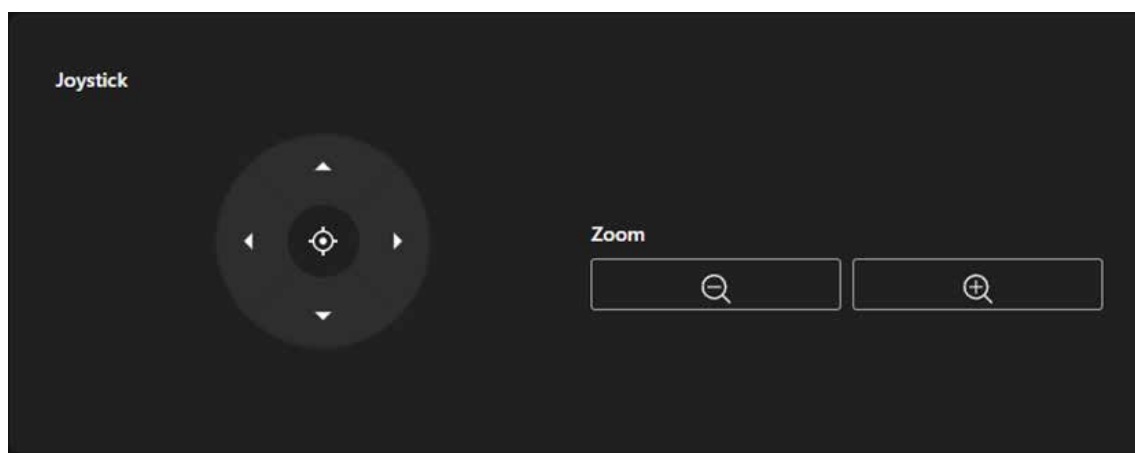

Direction Control

Provides a virtual joystick with directional buttons for up, down, left, and right, enabling users to operate the camera's pan and tilt in real time.

Clicking the directional arrows moves the camera in the corresponding direction.

Center Positioning

The central button can be used to quickly reset or reposition the camera to its current center point or initial position.

Zoom Control

Zoom Out: Reduces the zoom level, expanding the camera's field of view.

Zoom In: Increases the zoom level, focusing on details or specific targets.

PTZ Settings

- **Home**

The Home enables users to set and restore the camera's baseline viewpoint, aiming to improve operational efficiency, simplify camera management, and ensure the stability and flexibility of the monitoring process.

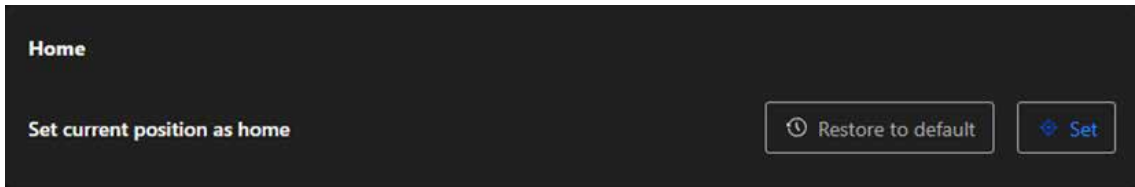

Set Current Position as Home

By pressing the Set button, users can designate the camera's current viewpoint (direction and zoom) as the Home position, serving as the default baseline.

Restore to Default

By pressing the Restore to Default button, the camera's Home position will be reset to its factory settings or the predefined default position.

Restore to Default

By pressing the Restore to Default button, the camera's Home position will be reset to its factory settings or the predefined default position.

- **Preset**

The Preset allows users to easily manage multiple surveillance viewpoints of the camera, aiming to simplify operations, enhance efficiency, and meet the needs of flexible monitoring in various scenarios.

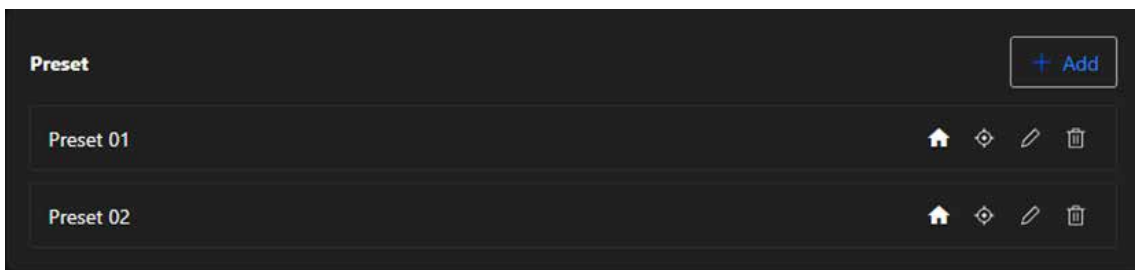

PTZ Settings

Add Preset

By using the + Add button, users can save the camera's current viewpoint (direction and zoom) as a new preset, enabling quick access to that position in the future.

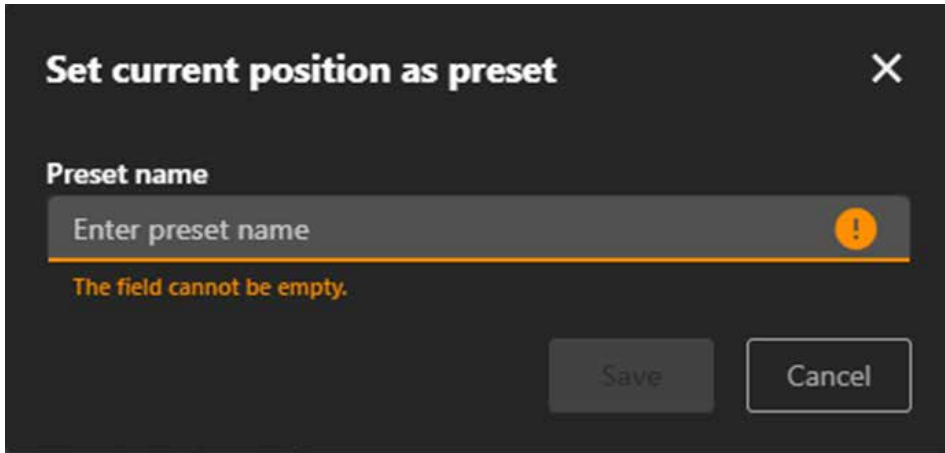

Preset List

Saved presets are displayed in a list format (e.g., Preset 01 and Preset 02). Users can perform the following actions for each preset:

Set as Home

Assign a preset as the Home position (via the house icon), making it easy to return to that point.

Switch to Preset

Click on a preset item to quickly move the camera to that viewpoint.

Edit

Modify the name or the associated viewpoint of the preset.

Delete

Remove presets that are no longer needed.

Patrol

The Patrol feature utilizes automated patrol routes to enable the camera to efficiently cover multiple surveillance points, reducing manual intervention and achieving comprehensive and flexible monitoring management.

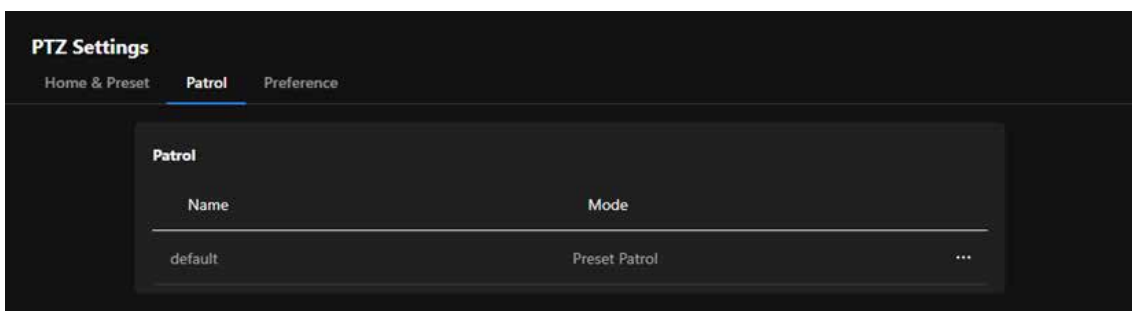

PTZ Settings

The purpose are as follows:

Achieving Automated Patrol

Through predefined patrol routes, the camera can automatically move sequentially to different surveillance points, ideal for large-scale or multi-area monitoring needs.

Reducing Manual Operations

The automation feature eliminates the need for frequent manual control, enhancing monitoring efficiency and saving manpower.

Adapting Flexibly to Scene Requirements

Customizable patrol routes and multi-mode support allow the system to adapt to dynamic scenarios or diverse surveillance targets.

Enhancing Security

By regularly patrolling all preset points, the system ensures that every critical area is monitored in a timely manner, reducing the risk of blind spots in surveillance.

Edit Patrol Route

Step 1. Click “More” icon > “Edit” button

Click the Edit button on the right side of the existing route.

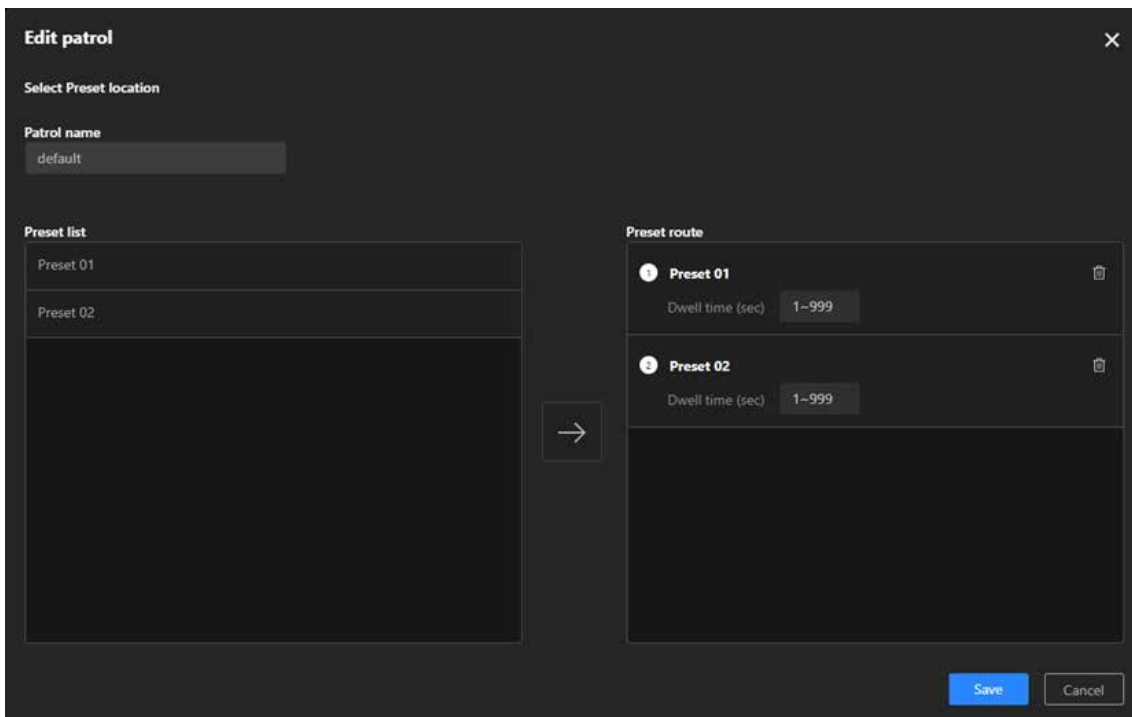

Step 2. Select Preset Points

The Preset List on the left displays the configured preset points. Browse the list and select the points you want to include in the patrol route.

PTZ Settings

Step 3. Add to Patrol Route

After selecting a preset point on the left, click the arrow “▶” in the middle to add it to the Preset Route list on the right.

Step 4. Set Dwell Time for Each Preset Point

In the Preset Route list, assign a dwell time (in seconds) for each added preset point. The dwell time can range from 1 to 999 seconds, adjusted based on monitoring needs.

Step 5. Adjust Patrol Order

To change the patrol order of preset points, adjust their positions in the list on the right (drag, or delete and re-add them). Remove extra preset points: Click the Trash Can button next to the preset point.

Step 6. Save the Route

After confirming all preset points, dwell times, and order, click the Save button in the lower-right corner to save the route.

Step 7. Activate Patrol Mode

Return to the Installation category and click the Patrol icon on the PTZ panel to start the Patrol.

Preference

The Preference offers features such as speed adjustment and zoom display, enabling users to flexibly adjust camera operation parameters according to their needs, achieving more efficient and precise surveillance management.

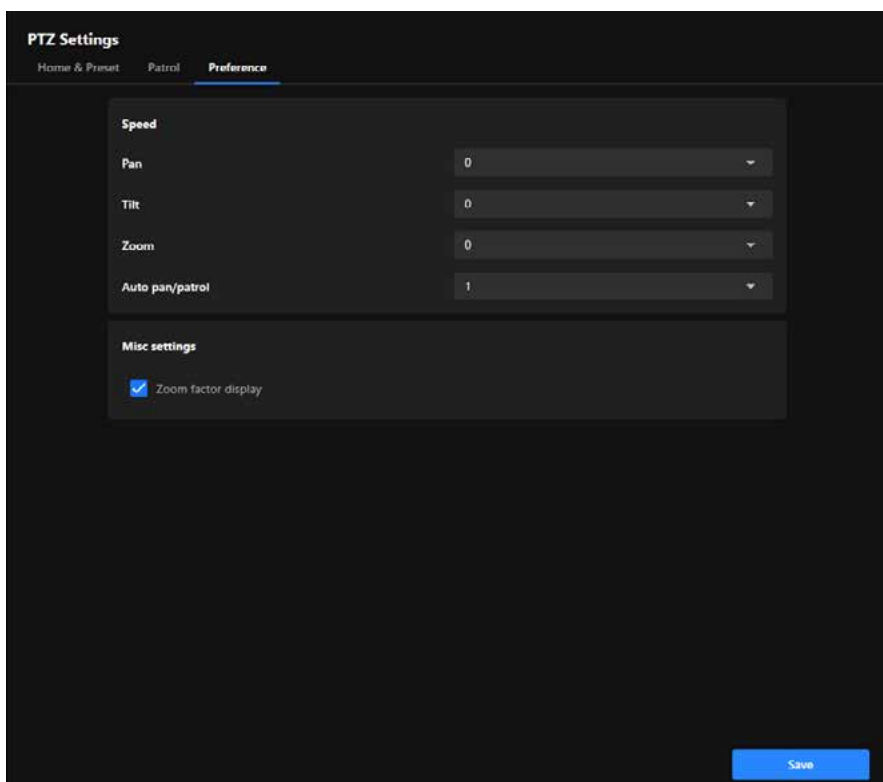

PTZ Settings

The purpose are as follows:

Enhancing Operational Flexibility

Different scenarios may require different speed settings. By adjusting pan, tilt, and zoom speeds, users can achieve more precise control of the camera.

Adapting to Diverse Surveillance Needs

In patrol mode or manual operation, users can set appropriate automatic movement and zoom speeds based on the importance of the scene or the speed of moving targets.

Improving Surveillance Accuracy

The zoom level display feature allows users to clearly understand the current magnification, making it suitable for surveillance scenarios that require focusing on details.

Simplifying Personalized Settings

Users can configure parameters that align with their operational preferences, enhancing overall efficiency.

- **Speed**

The Speed provides comprehensive control over the camera's movement speed, including pan, tilt, zoom, and automated patrol, allowing users to flexibly adjust the speed based on surveillance needs for precise and efficient camera operation.

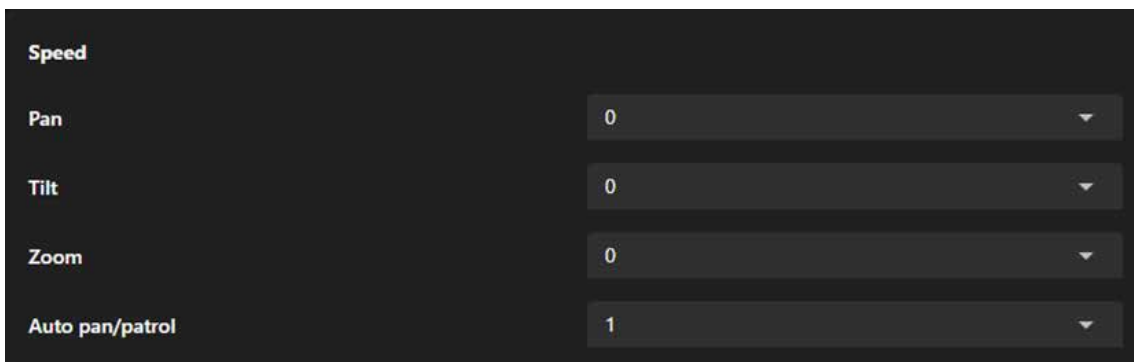

Pan (Horizontal Panning Speed)

Controls the speed at which the camera moves left and right.

Tilt (Tilting Speed)

Adjusts the speed at which the camera moves up and down.

Zoom (Zooming Speed)

Configures the speed at which the lens zooms in and out. Ideal for quickly focusing on details or slowly zooming to maintain a smooth transition.

Auto Pan/Patrol (Automatic Panning/Patrol Speed)

Sets the movement speed of the camera in auto-panning or patrol mode. Enables users to adjust the speed to suit surveillance needs, such as faster coverage for large areas or slower movement for observing details.

PTZ Settings

Misc settings

The Zoom Factor Display in Misc settings is designed to enhance user control and convenience during zoom operations, ensuring precision and effectiveness in monitoring, especially in scenarios that require frequent zooming or focusing on details.

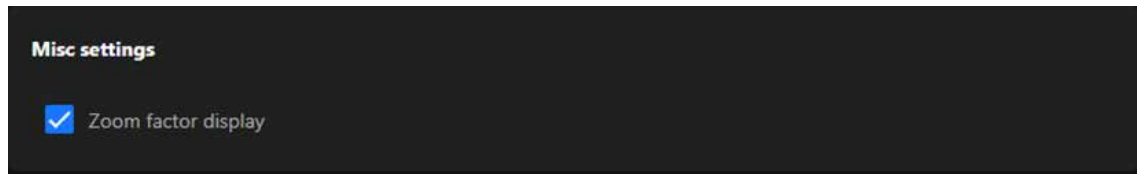

Zoom Factor Display

When this option is selected, the system will display the current zoom factor whenever the camera's zoom function is used. The zoom factor is typically presented in numerical form, allowing users to easily understand the current magnification level of the lens.



PTZ Settings

Caution:

PTZ settings are only available for supported Media Profiles. This means not all Media Profiles can operate PTZ settings; users must select a supported Media Profile to enable the PTZ function. If a user navigates to the PTZ Settings page and the currently active Media Profile does not support PTZ functionality, the system will display a notification: "Please select the profile which supports ePTZ before you operate PTZ control."

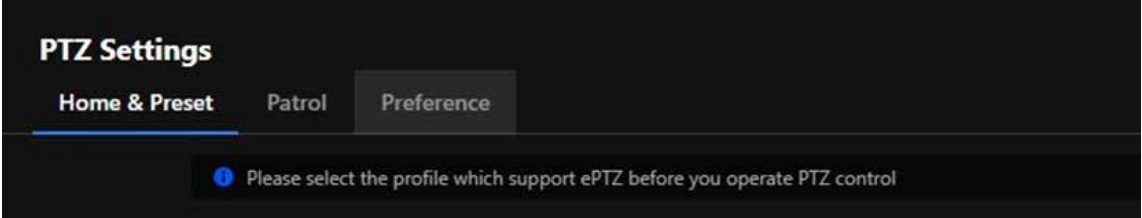

This notification serves as a prompt to guide users to switch to an appropriate profile (2nd or 3rd).



App

Expand Camera Functionality with Powerful Applications

The App feature provides users with a centralized platform for managing, installing, and updating applications on the camera, aiming to enhance the device's flexibility, security, and functionality, enabling it to adapt to diverse surveillance scenarios and requirements.

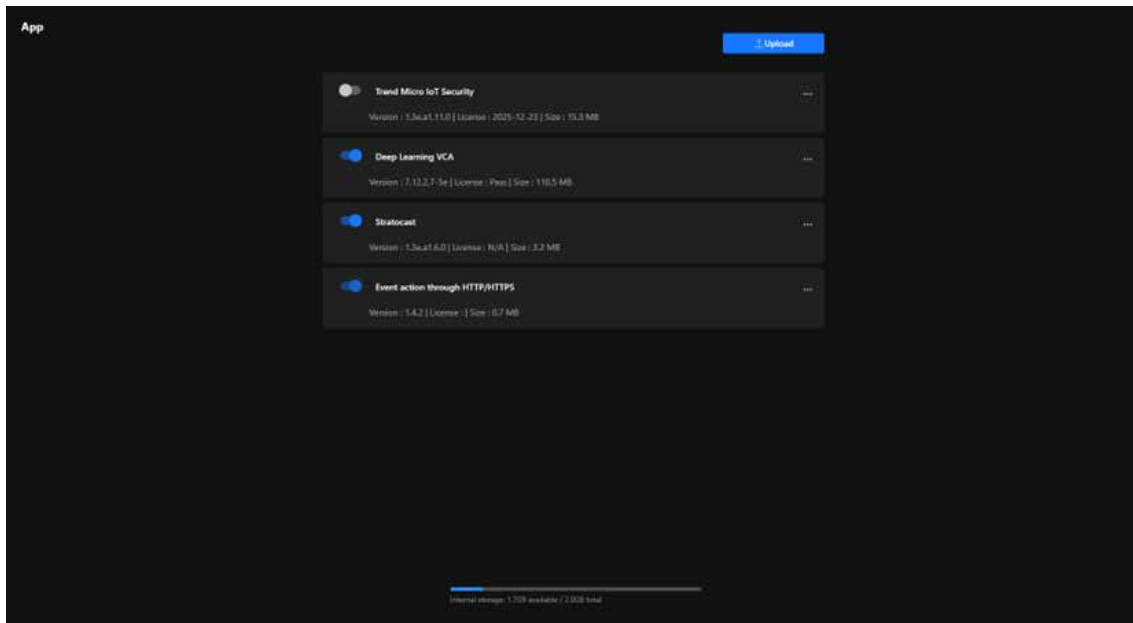

Event action through HTTP/HTTPS

The main purpose of this feature is to enable smart automation and integration with external systems. Specific use cases include:

- Notifications & Alerts

When an event occurs, the camera can send an HTTP/HTTPS request to a specified server or API, such as:

- Sending an alert to a monitoring center
- Triggering third-party systems (e.g., NVR, VMS, or cloud platforms)
- Reporting events to IoT or SCADA systems for further automation

- Triggering Other Systems

It can trigger other smart devices or systems, such as:

- Opening or closing access control systems
- Activating alarms or warning lights
- Notifying AI analytics systems for further processing

- Integration with Third-Party Applications

Allows integration with enterprise or cloud-based APIs, such as:

- Sending data to a RESTful API for event logging
- Integrating with cloud-based smart surveillance platforms
- Triggering scripts for automation control

App

Trend Micro IoT Security

A security application provided by Trend Micro, designed specifically for IoT devices. Its main functional purposes are as follows:

Enhance Camera Security

Protects the camera from network attacks that may disrupt its operation.

Safeguard Data Privacy

Ensures the security of video data and settings, preventing unauthorized access.

Reduce Maintenance Costs

Minimizes device failures or data loss caused by security issues.

Deep Learning VCA

A Visual Content Analysis (VCA) application, an AI-powered tool based on deep learning technology for intelligent video processing. Its main functional purposes are as follows:

Enhance Surveillance Accuracy

Reduces false positives and missed detections in manual monitoring, enabling intelligent video surveillance.

Automate Management

Achieves automatic event recognition and alarm triggering through AI analysis.

App

Handle Complex Scenarios

Supports real-time monitoring and analysis in large-scale, high-traffic, or multi-vehicle environments.

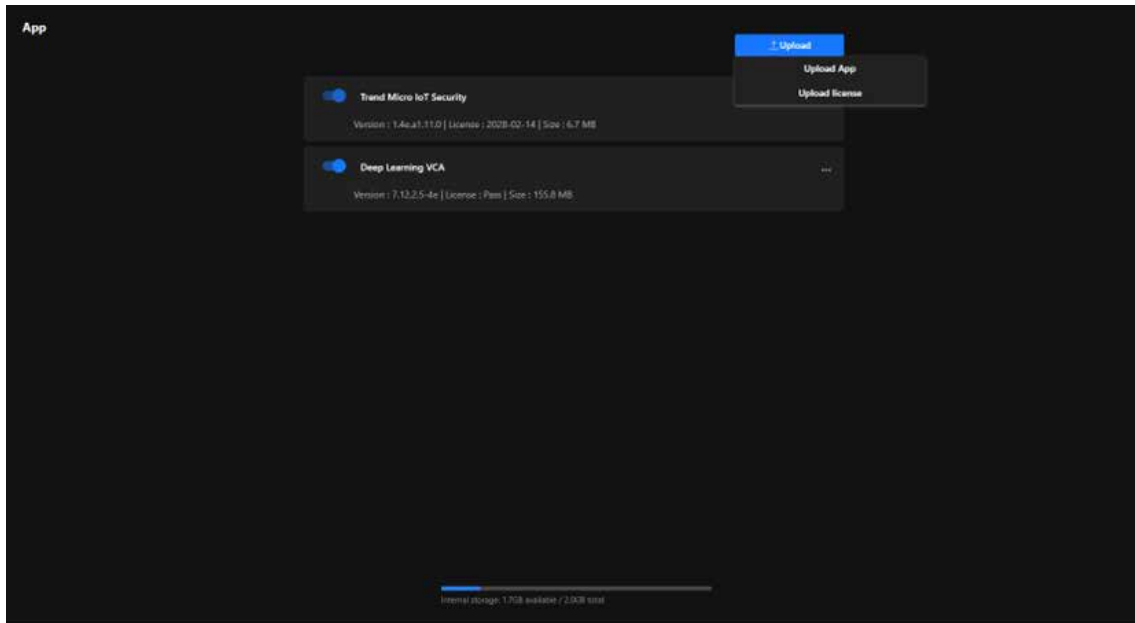

Step to Upload App

Step 1. Click the "Upload" button in the upper-right corner of the page. Two options will appear:

Upload App: For uploading application files.

Upload License: For uploading application license files.

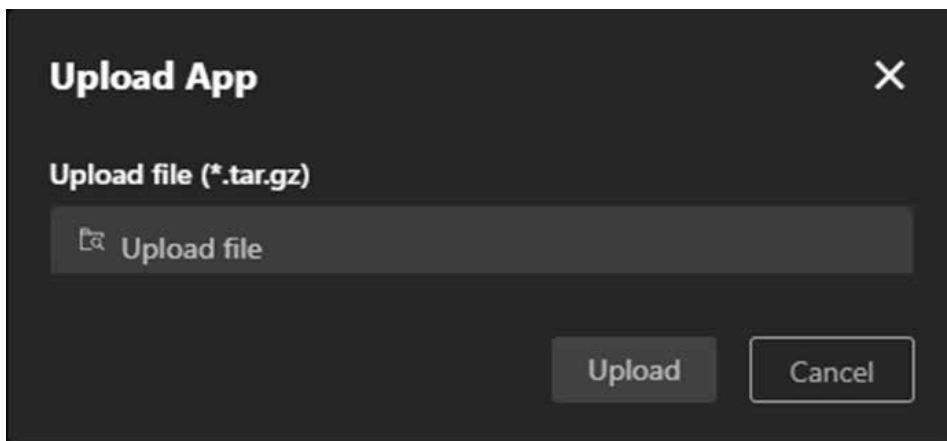

Step 2. Click Upload App, and a file upload window will pop up. The accepted file format is .tar.gz.

Step 3. Click Upload file, and select the application file stored on your local device.

Step 4. After verifying the file, click Upload to upload the application.

Step 5. Wait for the Upload to Complete.

Step 6. The system will display the upload progress. Once completed, the application or license file will appear in the App list.

App

Step to Upload License

Step 1. Click the Upload button in the upper-right corner of the page. Two options will appear:

Upload App

For uploading application files.

Upload License

For uploading application license files.

Step 2. Click Upload License, and a file upload window will pop up. The accepted file formats is *.xml.

Step 3. Click Upload file, and select the appropriate license file.

Step 4. After verifying the file, click Upload to upload the license.

Step 5. Wait for the Upload to Complete

Step 6. A "Upload successfully" message appears.

Each application's More icon (click the three-dot icon on the right) provides the following features and purposes:

Information

Monitor Application Status helps users quickly understand application details, ensuring the version and license are accurate, while also assisting in troubleshooting by providing essential information like version and license to diagnose issues effectively.

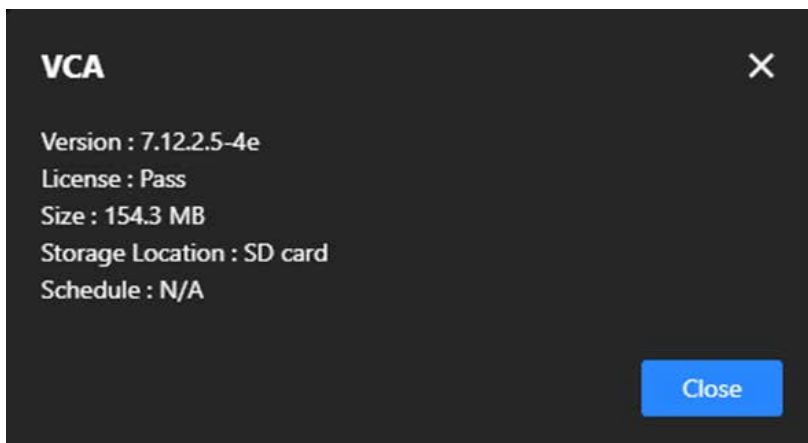

Schedule

Configure the application's runtime schedule to specify when it should be enabled or disabled, and set specific time periods to conserve resources or meet different scenario requirements. This feature optimizes resources by preventing unnecessary long-term application operation, conserving processing power, and adapts to various scenarios by automating application start and stop, enhancing flexibility.

Delete

Free up storage by removing unneeded applications, especially when storage is limited, and adjust functionality by deleting unused or expired applications to make room for new installations.

Detection

The purpose of the Detection is to enhance the automated monitoring capabilities of the camera, reduce manual intervention, and promptly notify relevant personnel in the event of anomalies, thereby improving security and efficiency. Users can enable and configure the corresponding detection options in the management interface based on specific needs.

Advanced Video Analysis for Proactive Security and Precision Monitoring

VIVOTEK integrates the advanced Smart VCA (Video Content Analysis) feature into its cameras, leveraging artificial intelligence and machine learning to analyze video footage in real time. It surpasses traditional surveillance methods by offering smarter detection capabilities beyond basic motion detection. Smart VCA can identify specific events or behaviors, making it a powerful tool for proactive security and monitoring.

Smart VCA

Smart VCA (Video Content Analysis) leverages artificial intelligence and machine learning to analyze video footage in real-time. It enhances traditional surveillance by offering intelligent detection capabilities beyond basic motion detection. Smart VCA allows the camera to identify specific events or behaviors, making it a powerful tool for proactive security and monitoring. Key Features and Benefits of Smart VCA:

Crowd Detection

Crowd Detection in Smart VCA is designed to identify areas where the number of people exceeds a predefined threshold. This feature ensures effective crowd control in public spaces by alerting users to potential overcrowding situations. By providing real-time monitoring, it enhances safety, helps manage crowd flow, and prevents dangerous conditions in sensitive or high-traffic areas, such as events, transportation hubs, or emergency evacuation zones.

Intrusion Detection

Intrusion Detection in Smart VCA is designed to monitor predefined zones and trigger alerts whenever an unauthorized person or object enters the area. This feature enhances security by proactively protecting restricted or high-security spaces, preventing unauthorized access, and ensuring that critical areas remain secure and free from potential threats.

Loitering Detection

Loitering Detection in Smart VCA identifies individuals lingering in a specified area for an unusually long duration. This feature helps detect suspicious behavior early, enabling users to take preventative actions to mitigate potential security threats such as vandalism, theft, or unauthorized activities in sensitive areas.

Missing Object Detection

Missing Object Detection in Smart VCA alerts users when an object is removed from a predefined area. This feature enhances security by helping to prevent theft or unauthorized removal of critical items, ensuring that valuable assets remain protected at all times.

Detection

Unattended Object Detection

Unattended Object Detection in Smart VCA identifies objects left behind in a specific area. This feature enhances safety by promptly detecting potential security risks, such as unattended baggage in public spaces, allowing for timely investigation and response.

Line Crossing Detection

Line Crossing Detection in Smart VCA triggers an alert whenever an object or person crosses a user-defined virtual boundary. This feature is essential for monitoring boundaries and ensuring perimeter security, preventing unauthorized entry into restricted areas and enhancing overall access control.

Face Detection

Face Detection in Smart VCA identifies and tracks faces within the camera's field of view. This feature enhances access control, streamlines identification processes, and provides valuable support for post-event analysis during forensic investigations, ensuring greater security and accountability in monitored areas.

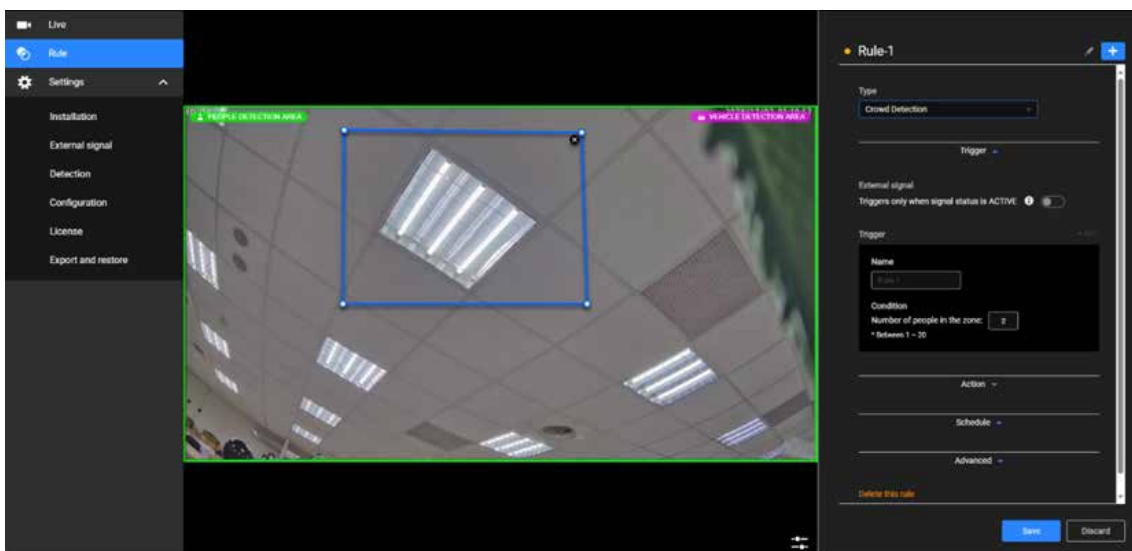

Steps to Add a Detection Rule

Step 1. Access the Smart VCA Settings.

Click "Detection" category > "Smart VCA" item on the Camera web UI.

The Smart VCA utility will be automatically started.

Note:

The Smart VCA and Smart Motion share the same utility window.

Step 2. Add a Rule.

In the Smart VCA utility, click the Add button to add a rule.

Select the Type:

Crowd Detection: Monitor the number of people in a specific area.

Intrusion Detection: Detect unauthorized entry into a defined area.

Loitering Detection: Detect people lingering for extended periods.

Missing Object Detection: Monitor the removal of objects.

Detection

Unattended Object Detection: Detect left-behind objects.

Line Crossing Detection: Monitor objects crossing a virtual boundary.

Face Detection: Detect and track faces in the scene.

Name the rule, such as "Crowd Zone 1".

Step 3. Define the Detection Area.

Draw the Area

Use the mouse to define the detection area on the video feed (e.g., outline the monitored zone). Adjust the size and shape as needed to precisely cover the target area.

Configure Area Based on Feature:

Line Crossing Detection: Draw a virtual line and set the crossing direction (A>B or B>A).

Crowd Detection and Intrusion Detection: Outline the specific area.

Missing Object/Unattended Object Detection: Outline the object's location.

Step 4. Configure Trigger Conditions.

Configure conditions based on the feature, such as:

Crowd Detection: Set a people count threshold (e.g., more than 5 people).

Loitering Detection: Define a linger duration (e.g., more than 10 seconds).

Intrusion Detection: Configure stay or entry conditions.

Missing/Unattended Object Detection: Define triggers (object removed or added).

Adjust sensitivity to avoid false alarms.

Step 5. Define Actions.

Assign actions to execute when the trigger conditions are met.

Configure multiple linked actions if necessary.

Step 6. Set a Schedule.

Always: The rule is enabled at all times.

Repeated schedule: Specify dates and time periods for the rule to be active (e.g., outside working hours).

Step 7. Click Save to save the rule.

Note:

Please refer to the Smart VCA user manual for more information. https://www.vivotek.com/products/analytics/smart_vca

Detection

Enhanced Accuracy and Efficiency in Surveillance with Smart Motion Detection

Enhanced accuracy and efficiency in surveillance with Smart Motion Detection are critically important for users, as they minimize false alarms and ensure security resources are focused on real threats. By precisely detecting people and vehicles while filtering out irrelevant movements, users can achieve reliable monitoring and reduce time wasted on unnecessary alerts. This level of precision and efficiency not only improves situational awareness but also enhances overall operational effectiveness, making it an indispensable tool for safeguarding critical areas and responding swiftly to potential risks.

Smart Motion

Smart Motion Detection is designed to improve the efficiency and accuracy of motion detection in surveillance systems. Its primary purposes include:

Reducing False Alarms

Smart Motion Detection minimizes unnecessary alerts caused by irrelevant motions such as moving shadows, light changes, or environmental factors like wind-blown leaves.

Enhancing Security Monitoring

By focusing on specific areas and detecting meaningful activities (e.g., people or vehicles), it allows security teams to respond more effectively to potential threats.

Improving Event Detection Accuracy

With intelligent filters like people and vehicle detection, it ensures that only relevant events are identified and recorded, reducing the effort required to review footage.

Optimizing Storage and Bandwidth

By recording only critical events, it reduces the amount of data stored and transmitted, leading to more efficient storage usage and lower bandwidth consumption.

Facilitating Real-Time Alerts

Smart Motion Detection enables instant notifications for events of interest, helping users take timely actions in critical situations.

Simplifying Event Analysis

By focusing on high-priority events, it simplifies post-event investigations and improves the efficiency of video footage review.

Detection

Step to configure Smart Motion Detection

Step 1. Access the Smart VCA Settings.

Click “Detection” category > “Motion” item on the Camera web UI.

The Smart Motion utility will be automatically started.

Note:

The Smart VCA and Smart Motion share the same utility window.

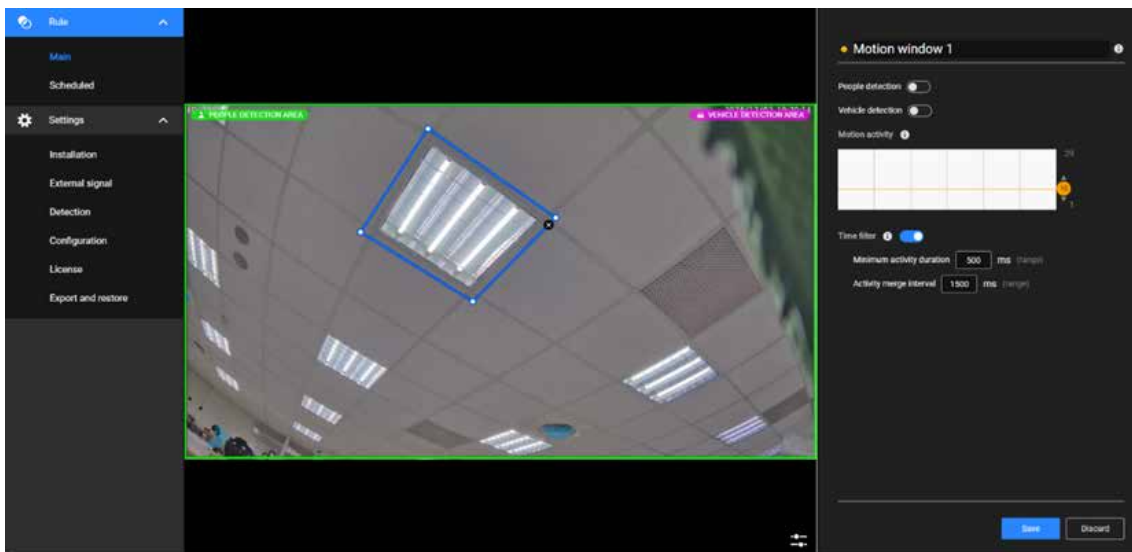

Step 2. Define the Detection Area.

Use the mouse to draw a shape on the live feed to specify the detection zone.

Step 3. Adjust Motion Sensitivity.

Set the motion sensitivity slider based on your environment (e.g., higher for indoor, lower for outdoor with more natural movements).

Step 4. Configure Time Filters.

Minimum Activity Duration: Define how long a motion must last to be considered an event.

Activity Merge Interval: Configure the interval to merge closely occurring events.

Step 5. Enable Object Detection (Optional).

Turn on “People Detection” and/or “Vehicle Detection” if applicable for your use case.

Note:

Please refer to the Smart VCA user manual for more information. https://www.vivotek.com/products/analytics/smart_vca

Detection

Enhancing Security with Real-Time Audio Anomaly Detection for Prompt Response

Audio detection enhances security by continuously monitoring ambient sound levels and identifying unusual audio patterns, such as loud noises, glass breaking, or shouting. By analyzing real-time sound data and triggering alerts when the sound exceeds a predefined threshold, it enables swift responses to potential security breaches or emergencies. This proactive approach ensures that critical events are detected even in situations where visual cues are insufficient, providing an additional layer of protection and improving overall situational awareness.

Audio detection

The audio detection feature in VIVOTEK cameras is a powerful tool for augmenting security and safety. By detecting sound anomalies in real-time, it enhances the camera's ability to monitor and respond to incidents effectively. Its primary purposes include:

Enhancing Security

Detects abnormal sounds (e.g., glass breaking, shouting, or explosions), enabling early identification of potential threats.

Supplementing Video Monitoring

Adds an extra layer of detection in situations where motion or visual triggers may not be effective (e.g., a quiet area with no visible motion).

Real-Time Alerts

Notifies security personnel immediately when unusual sounds are detected, allowing for faster responses.

Environmental Noise Monitoring

Useful for monitoring sound levels in specific areas, such as factories, schools, or public spaces, to ensure safety and compliance.

Event Recording

Helps ensure that audio-related incidents are documented for review and investigation.

Detection

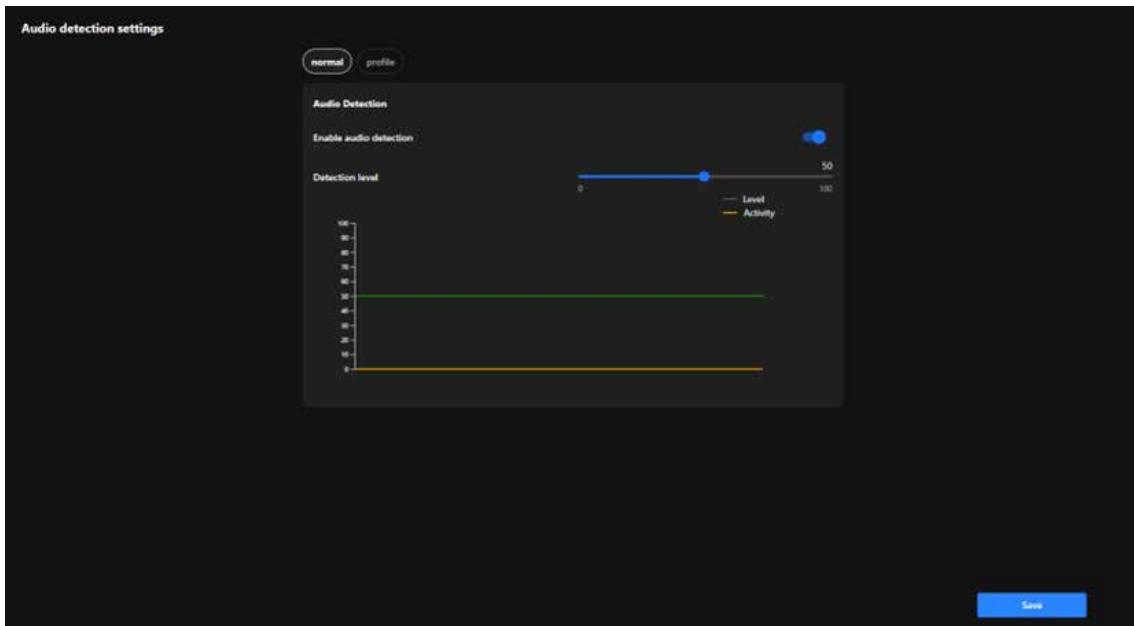

Step to configure the audio detection

Step 1. Enable Audio Detection.

Turn on the Enable Audio Detection toggle.

Step 2. Set the Detection Level.

Adjust the Detection Level slider.

Higher levels filter out normal background noise, detecting only loud or unusual sounds.

Lower levels detect even minor audio changes, useful for quieter environments.

Use the real-time graph to observe:

Green Line (Level): Represents the detection threshold.

Orange Line (Activity): Represents the live audio levels.

Adjust the slider to set an appropriate threshold based on your environment.

Detection

Integrate audio detection-related settings into a profile

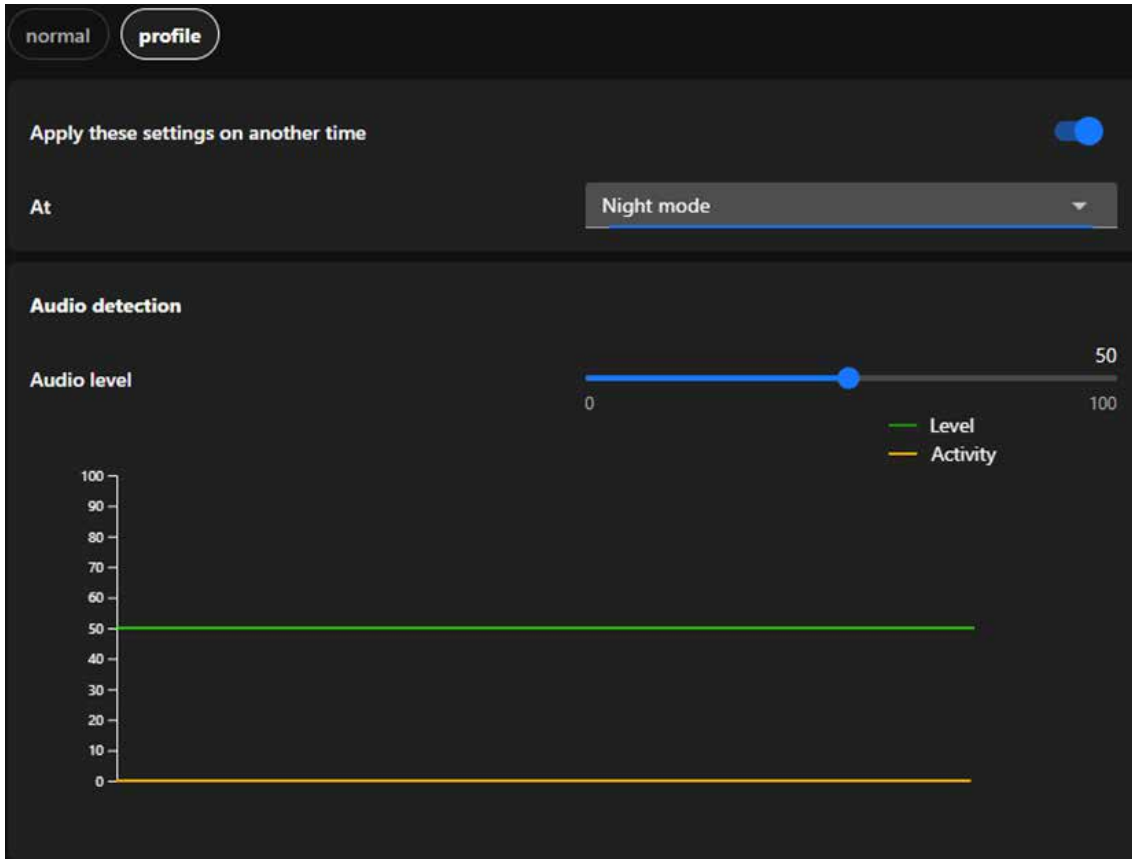

The Profile Settings for Audio Detection allow users to configure detection settings tailored to specific operational modes, such as Night Mode and Schedule Mode. These settings provide flexibility and precision for various monitoring needs.

Night Mode

Designed for quieter nighttime environments with lower ambient noise levels, it ensures heightened sensitivity to detect unusual sounds, such as breaking glass or loud footsteps, that might indicate security breaches. Lower thresholds for audio level detection can be applied to ensure even minor disturbances trigger an alert, and the system can be activated automatically during preset nighttime hours.

Schedule Mode

It allows users to apply specific settings during predefined time periods, such as working hours, weekends, or off-peak times, ensuring customized detection settings based on predictable noise patterns. It enables precise scheduling for when audio detection thresholds or profiles should be active, tailoring the sensitivity to the expected noise environment during the scheduled time.

Detection

Ensuring Real-Time Protection Against Physical Impact

Shock detection provides real-time alerts to users when the camera experiences physical impacts or vibrations, ensuring immediate awareness of accidental damage. This proactive monitoring improves the reliability of the security system by protecting the camera from disruptions, reducing downtime, and maintaining consistent surveillance coverage to effectively safeguard critical areas.

Shock detection

The Shock Detection feature in VIVOTEK cameras is designed to detect physical impacts or vibrations affecting the camera. Using built-in sensors, it monitors for sudden movements or shocks, and when detected, it triggers an immediate alert to notify users. Its primary purposes include:

Prevent Damage

Protect the camera from potential physical harm caused by tampering, vandalism, or accidental impact.

Real-Time Alerts

Ensure users are informed immediately when physical interference occurs, allowing for quick response.

Maintain Operation

Help ensure the continuous functionality of the camera by identifying physical disturbances promptly.

Reinforce Security

Enhance the reliability of the surveillance system by preventing disruptions caused by physical impact.

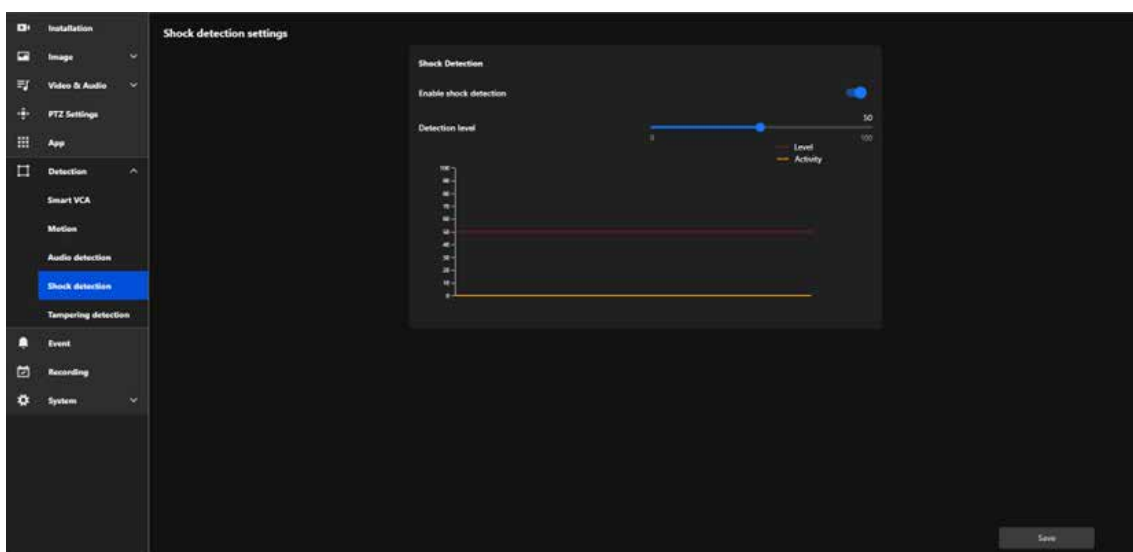

Step to configure the shock detection

Step 1. Access the Audio detection settings.

Click "Detection" category > "Shock detection" item on the Camera web UI.

Detection

Step 2. Enable Shock Detection.

Turn on the Enable Shock Detection toggle.

Step 3. Set the Detection Level.

Adjust the Detection Level slider.

Higher levels ignore smaller impacts and focus on more significant events.

Lower levels detect minor shocks or vibrations.

Observe the Level (Red Line) and Activity (Yellow Line) graphs:

The red line represents the configured detection threshold.

The yellow line shows real-time shock activity.

Adjust the slider until the threshold matches your environmental needs.

Protecting the Surveillance System from Visual Obstruction

To ensure optimal performance and clear monitoring, protecting your surveillance system from visual obstruction is crucial. Regularly inspect and maintain cameras to prevent blockages caused by dirt, debris, or weather conditions. Strategically position cameras to avoid obstructions from vegetation, building structures, or temporary barriers. Advanced features such as obstruction detection alerts can further enhance reliability, ensuring uninterrupted surveillance coverage for critical areas.

Tampering detection

Tamper detection is an advanced camera feature designed to identify incidents such as blocking, defocusing, or spray paint interference. This functionality enhances the integrity and reliability of surveillance systems by ensuring clear and accurate monitoring while providing timely alerts. Its primary purposes include:

Preventing Sabotage

Detects and alerts users about attempts to disrupt the camera's operation, such as covering, defocusing, or physically tampering with the device.

Maintaining Image Quality

Monitors brightness and focus to ensure consistent video quality, providing actionable alerts if anomalies are detected.

Enhancing Security

Adds an additional layer of protection by identifying visual impairments or malicious actions that compromise the surveillance system.

Timely Response

Delivers real-time alerts to enable security personnel to respond immediately to tampering incidents or visual issues.

Detection

Operational Reliability

Ensures continuous, high-quality monitoring, even in challenging or high-risk environments.

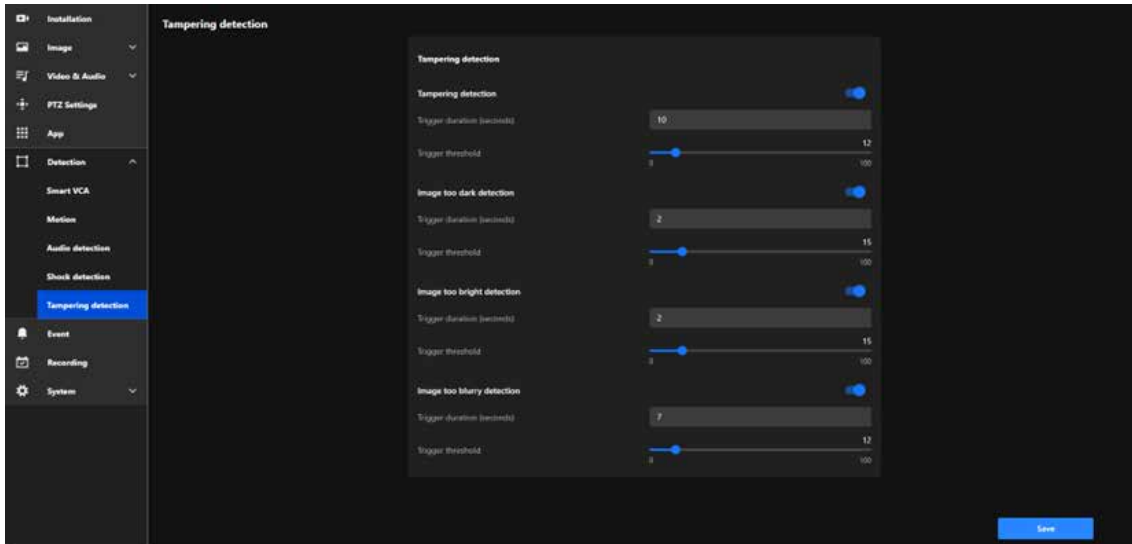

Below are the detailed functionalities and corresponding settings for each feature:

Tampering detection

Detects physical tampering, including actions like blocking, covering, or moving the camera, ensuring immediate alerts to maintain surveillance integrity.

Trigger Duration (seconds):

Defines the amount of time tampering must persist before triggering an alert.

Trigger Threshold:

Adjusts the sensitivity to tampering attempts. Lower thresholds are more sensitive but may result in false alarms, while higher thresholds are less sensitive.

Image too dark detection

Detects when the video stream becomes abnormally dark due to intentional actions (e.g., turning off lights) or environmental changes, ensuring timely alerts to address potential issues.

Trigger Duration (seconds):

Sets the duration the image must remain dark to trigger an alert.

Trigger Threshold:

Adjusts the sensitivity to darkness. Lower thresholds detect smaller changes, while higher thresholds focus on significant darkness levels.

Image too bright detection

Detects when the video stream becomes overexposed, potentially caused by intense light directed at the camera (e.g., flashlights) to obscure visibility, ensuring immediate alerts to maintain surveillance integrity.

Trigger Duration (seconds):

Specifies how long the brightness issue must persist before triggering an alert.

Detection

Trigger Threshold:

Adjusts sensitivity to brightness changes. Lower thresholds detect minor overexposure, while higher thresholds only trigger for severe brightness levels.

Image too blurry detection

Identifies when the video feed becomes blurry due to defocusing, lens obstruction, or environmental factors such as condensation or dirt, ensuring timely alerts to maintain clear surveillance.

Trigger Duration (seconds):

Defines how long the blurriness must persist to trigger an alert.

Trigger Threshold:

Adjusts sensitivity to blurriness. Lower thresholds detect minor blurring, while higher thresholds focus on significant quality degradation.

Event

Event is a powerful tool designed to enhance security through automation and intelligent monitoring. It allows users to define specific conditions, known as trigger sources, that activate pre-configured actions such as recording, sending alerts, or controlling external devices. By customizing these events with detailed schedules and conditions, users can ensure the system responds proactively to potential threats or anomalies. This feature not only streamlines surveillance operations but also reduces the need for constant manual monitoring, providing a reliable and efficient way to protect property and assets.

Enhancing Security with Automated and Customizable Event

To enhance security with automated and customizable events, users can configure specific conditions to activate surveillance actions. For example, motion detection, sound detection, or tampering can be set as trigger sources. Once triggered, the camera can automatically record footage, send alerts via email, or activate connected devices like alarms. Users can further customize these events by setting schedules, such as enabling detection only during nighttime, or by linking multiple triggers for advanced scenarios. This flexibility ensures a proactive and efficient security solution tailored to the user's unique needs.

Event

Event is a smart automation tool designed to enhance the efficiency and effectiveness of security monitoring. Its primary purpose is to detect specific conditions or triggers and automatically execute predefined actions to respond to those events. This reduces the need for constant manual monitoring and ensures timely reactions to critical incidents.

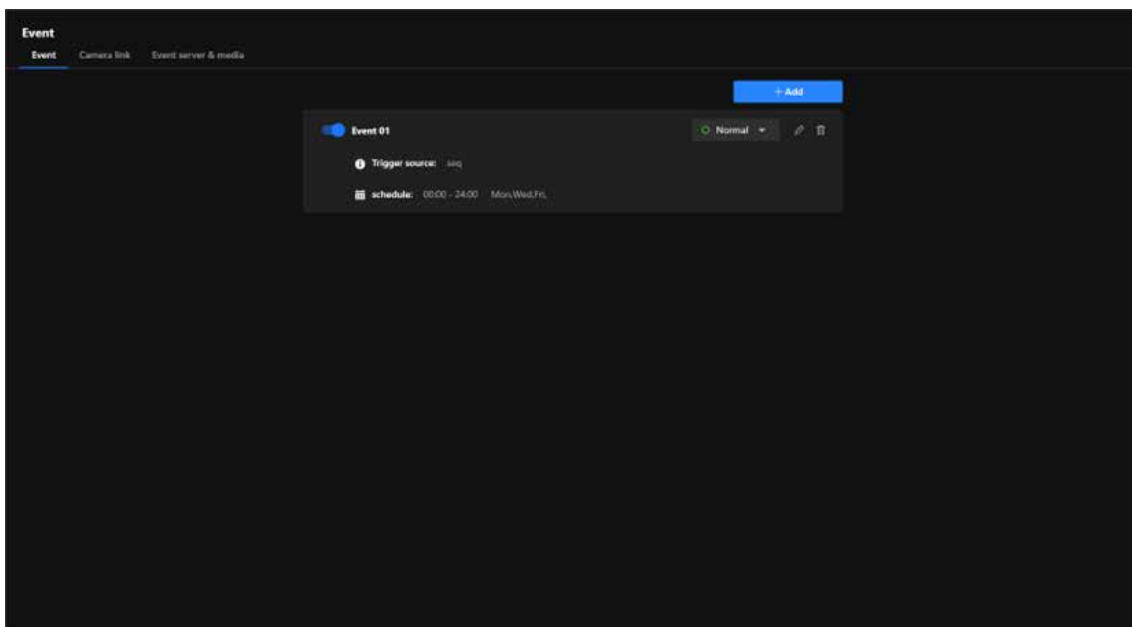

Key purpose of Event:

Enhance Security

By enabling cameras to respond instantly to suspicious activities, such as intrusions or tampering, users can prevent incidents before they escalate.

Event

Increase Efficiency

Automating responses eliminates the need for constant manual monitoring, saving time and resources.

Provide Evidence

Automatic recording and snapshot capture ensure crucial moments are documented for investigations.

Proactive Problem Solving

Alerts for device or network issues allow users to address problems quickly, reducing downtime or vulnerabilities.

Steps to Add an Event

Step 1. Enter Event Name

Click "+ Add" button on "Event" configuration tab.

In the Event Name field, enter a descriptive name for the event.

Set the trigger interval. This determines how long the system waits before detecting the same event again.

Click Next to proceed.

Step 2. Select the Trigger Source

Choose a trigger source from the list:

Device

These triggers are based on the camera itself or external devices connected to it.

Detection

These triggers rely on the camera's built-in intelligent analysis features to detect changes or abnormalities in the environment.

Recording

These triggers are based on the recording status of the camera.

VADP

VADP (VIVOTEK Application Development Platform) provides advanced trigger options supported by custom applications.

Event

Network

These triggers are based on the network status or conditions. Configure any additional settings for the selected trigger source. Click Next to continue.

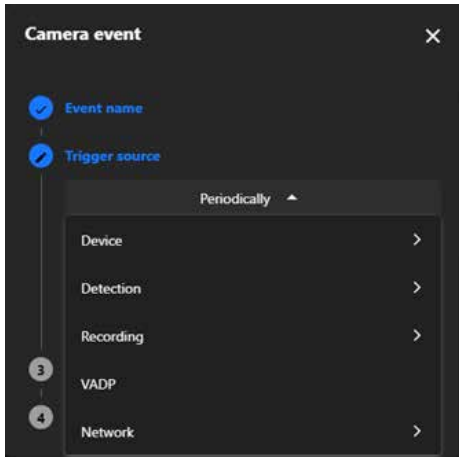

Step 3. Define Actions

Select the actions to be performed when the event is triggered:

Digital Output

Activate an external device, such as an alarm.

Backup

Backup video footage to storage if the network is disconnected.

Audio Clips

Play a pre-configured audio clip (requires prior audio setup).

Camera Link

Link to other cameras for coordinated responses.

Event Server & Media

Define the storage location, such as:

- 0. SD card
- 1. NAS

Customize the action settings as needed.

Click Next to proceed.

Event

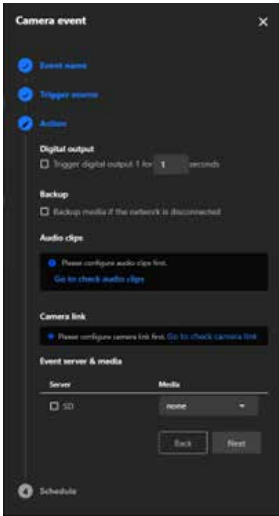

Step 4. Set the Schedule

Define when the event should be active:

Always: The event will always be active.

Specific Times: Configure the event to only be active during certain times (e.g., only at night).

Review the schedule and confirm it.

Click Save to finalize the setup.

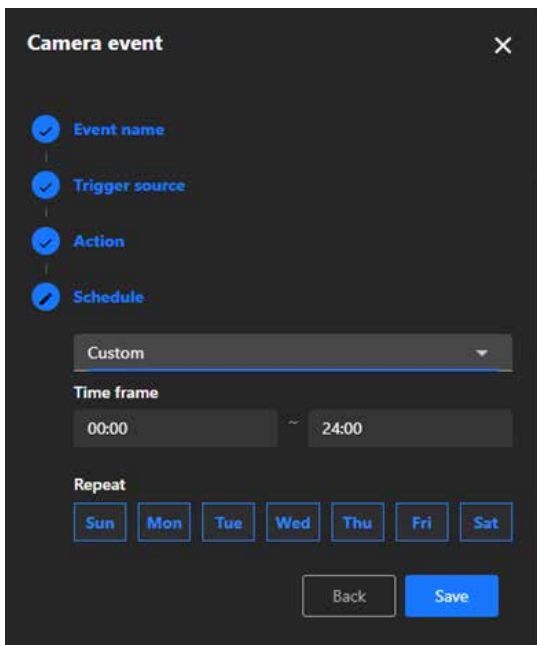

Event

Note:

The types of Event triggers:

Device	
Periodically	The event is triggered at regular intervals, as defined by the user.
System Boot	The event is triggered when the camera starts up.
Manual Trigger	The event is manually triggered by the user.
Digital Input	The event is triggered by a digital signal from an external device, such as a sensor.
Detection	
Motion Detection	The event is triggered when the camera detects a moving object in its field of view.
Tampering Detection	The event is triggered when the camera detects tampering, such as being covered, moved, or obstructed.
Audio Detection	The event is triggered when the camera detects abnormal sounds, such as sudden loud noises.
Shock Detection	The event is triggered when the camera detects physical shocks or vibrations.
Recording	
Recording Notification	The event is triggered when recording starts or stops.

Event

VADP	
BruteForceAttack	The event is triggered when repeated failed login attempts are detected, indicating a potential brute force attack on the camera system.
CyberAttack	The event is triggered when suspicious network activities resembling a cyberattack targeting the camera are identified.
LicenseExpiration	The event is triggered when the software or feature license is approaching expiration, alerting users in advance.
Quarantine	The event is triggered when unauthorized breaches or violations occur in a designated quarantine zone.
Crossed	The event is triggered when an object or person crosses a predefined virtual boundary.
ObjectsInCrowd	The event is triggered when crowd formation or high object density is recognized in a specific area.
ObjectsInside	The event is triggered when objects enter a user-defined monitored area.
ObjectsLoitering	The event is triggered when objects or individuals linger in a designated area for an extended period.
ObjectsRunning	The event is triggered when fast-moving objects, such as running individuals, are identified within the camera's field of view.
ObjectsAbandoned	The event is triggered when items are left unattended in a monitored zone.
ObjectsMissing	The event is triggered when objects are removed or disappear from a predefined area.
Face	The event is triggered when human faces are recognized for identification or tracking purposes.
Violated	The event is triggered when a restricted or prohibited action occurs in a defined area.

Event

VADP	
ObjectIsRestricted	The event is triggered when objects enter or remain in restricted zones where they are not permitted.
Network	
Certificate Expiration Notify	The event is triggered when the security certificate is about to expire.

Enhance Multi-Camera Coordination and Eliminate Blind Spots with Camera Link

The Camera link in Event settings enables seamless integration and coordination among multiple cameras, ensuring comprehensive surveillance coverage and eliminating potential blind spots. By facilitating interaction and collaborative responses to triggers, this feature enhances situational awareness, improves monitoring efficiency, and provides a robust solution for complex security environments. Whether managing large facilities, monitoring multiple zones, or ensuring full coverage in critical areas, Camera Link empowers users with intelligent, event-driven operations tailored to their specific needs.

Camera link

The Camera Link operates by enabling one camera to trigger actions on other linked cameras when an event occurs. For example, the Camera Link feature enables a general form factor camera to pair with a PTZ camera. When motion is detected in Motion Window #1, the paired PTZ camera will automatically move to the designated preset position and initiate object tracking. This coordinated response ensures comprehensive event coverage, effectively eliminating blind spots by capturing multiple perspectives in real time, even in complex or large surveillance areas.

Key purpose of Camera link

Multi-Camera Coordination

When an event is detected by one camera, it can trigger actions on other linked cameras, such as playing an audio clip, moving to a preset location, or starting smart tracking for PTZ cameras. This makes it ideal for small-scale monitoring scenarios where no VMS (Video Management System) is available for central management.

Centralized Management

The Camera Link feature consolidates multiple cameras into a unified system, streamlining operations and boosting efficiency, making it particularly beneficial for monitoring systems in security control centers, smart buildings, or commercial complexes.

Event

Enhanced Security

The Camera Link feature allows for multi-angle coverage of critical areas by enabling other cameras to automatically capture footage from different viewpoints when an event is triggered in one zone, effectively reducing blind spots and improving situational awareness.

Data Integration and Event Logging

Events and recordings from multiple cameras can be centralized in one server or storage system, enabling seamless event tracking and analysis.

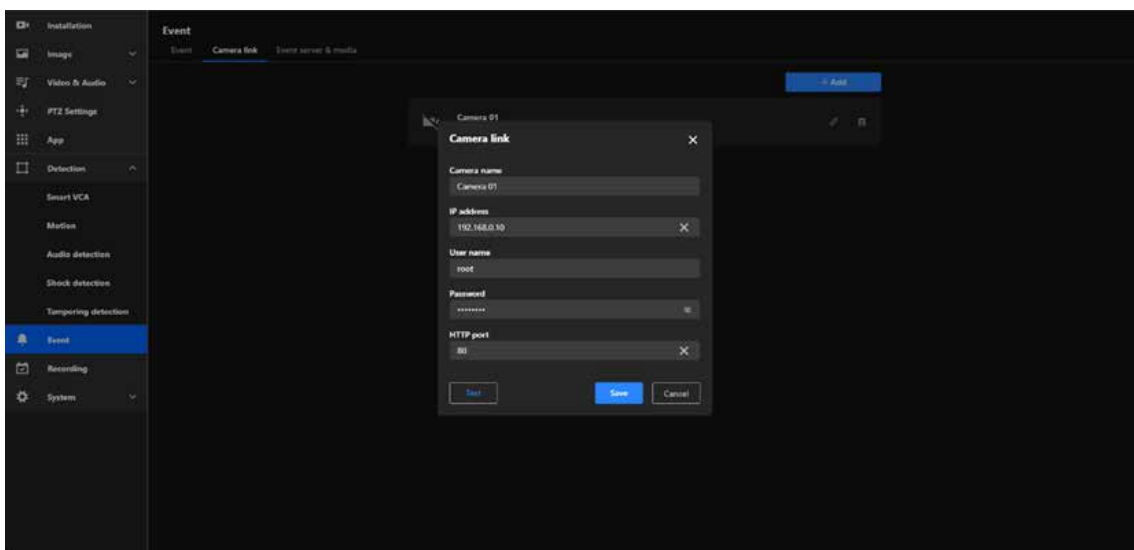

Steps to Add a Camera link

Step 1. Click on the + Add button to create a new camera link entry.

Step 2. Fill in Camera Details:

Camera Name: Enter a descriptive name for the linked camera.

IP Address: Provide the IP address of the target camera you want to link.

Username: Enter the username required to authenticate with the target camera, usually “root” by default.

Password: Enter the corresponding password for the username.

HTTP Port: Specify the HTTP port used by the target camera. By default, this is usually 80, unless it has been customized.

Step 3. Click the Test button to ensure the connection details are correct and the camera link is successfully established.

Step 4. Once the connection is successfully tested, click the Save button to store the camera link configuration.

Event

Trigger Automated HTTP/HTTPS Requests for Event-Based Integration

The VIVOTEK cameras can send HTTP/HTTPS requests to a specified server or API when a specific event occurs. This enables integration with external systems for notifications, logging, or automation.

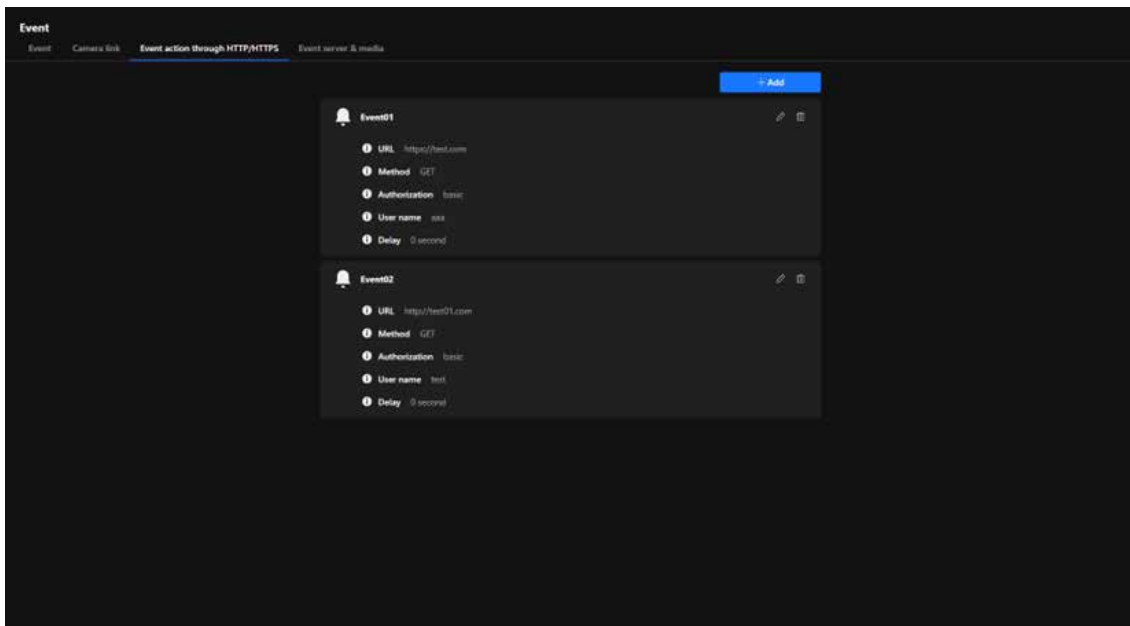

Steps to Add a new HTTP/HTTPS event action

Step 1. Click on the + Add button to create a new HTTP/HTTPS event action.

Step 2. Fill in details:

- **Server Name:** Identifies the event action.
- **Server Address:** The target server or API URL.
- **Header Key & Value:** Optional HTTP headers.
- **Method:**
 - **GET:** Requests data from the target server, typically for information retrieval.
 - **POST:** Sends data to the target server, typically for event reporting or triggering actions. When POST is selected, the Post Body type must be specified:
 - **Static:** Requires a manually entered Static Body, which remains the same for every event trigger.
 - **ONVIF Event:** Requires selecting an ONVIF Event Topic (e.g., tns1:RuleEngine/Motion Detector/Motion). The event will be sent using the ONVIF standard format, suitable for ONVIF-compliant systems.
- **Authorization:**
 - **Basic Authentication:** Requires User Name and Password.
 - **Digest Authentication:** A more secure authentication method than Basic Authentication, as the password is not transmitted directly but hashed instead. Still requires User Name and Password, with server-side challenge-response validation.

Event

- Delay:

Specifies the delay (in seconds) before executing the request after an event is triggered.

Step 3. Click the Test button to ensure the connection details are correct and the HTTP/HTTPS event action is successfully established.

Step 4. Once the connection is successfully tested, click the Save button to store the HTTP/HTTPS event action configuration.

Event action through HTTP/HTTPS ✕

Server name
Event01

Server address
https://test.com

Header key (Maximum:0/30) +
Enter header key : Enter header value

Method
GET ▾

Authorization
Basic ▾

User name
aaa

Password
..... 🔒

Delay
0

Test Save Cancel

Event

Effortless Event Management and Enhanced Security with Event Server & Media

The Event Server & Media offers robust functionality that simplifies event management, improves security, and enhances user convenience. It ensures that event data is handled efficiently, reliably, and in a manner tailored to each user's unique requirements, making it an invaluable tool for modern surveillance systems.

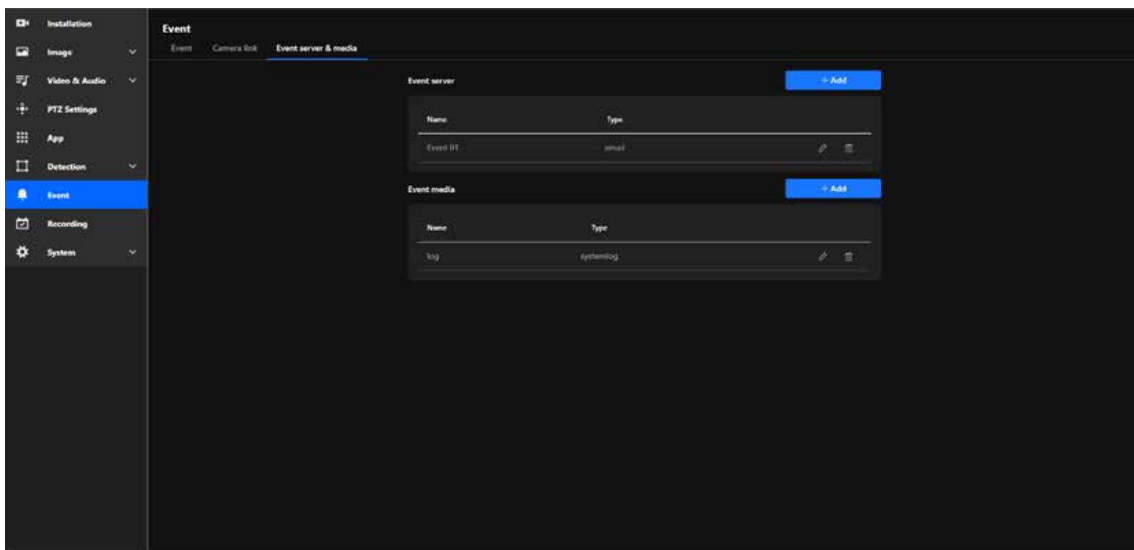

• Event server

By offering various types of event servers, VIVOTEK cameras provide a flexible and robust event management solution that can be customized to meet diverse security and monitoring requirements. The main functions and purposes of these servers are as follows:

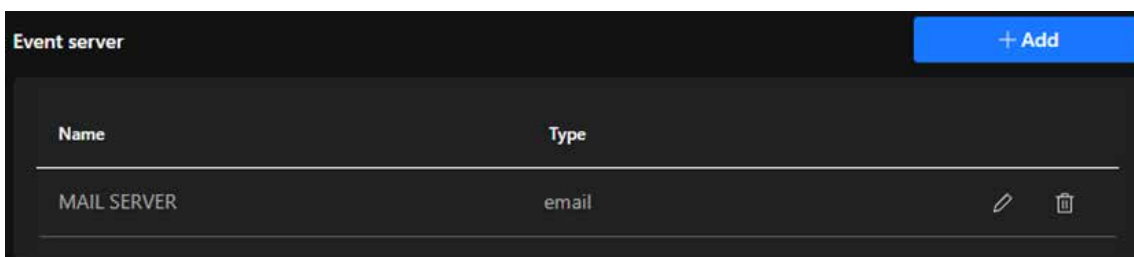

E-mail

This solution sends email notifications to predefined recipients whenever an event occurs, instantly alerting users with detailed event information. It also supports attaching snapshots or event-related data, making it an ideal choice for small-scale setups or individual monitoring needs.

FTP

This solution uploads event-related files, such as snapshots, videos, or logs, to an FTP server, providing centralized storage for event media. It is ideal for managing event data in environments with consistent network connectivity and is particularly suited for large-scale deployments that require organized and efficient storage solutions.

Event

SFTP

This solution securely uploads event-related files to an SFTP server using encryption protocols, enhancing data protection during transfer. It is ideal for environments requiring the safeguarding of sensitive information from interception or tampering and ensures compliance with strict security policies and regulatory requirements.

HTTP

This solution sends event notifications or data to an HTTP server via HTTP requests, enabling seamless integration with third-party systems or applications for efficient event handling. It can trigger workflows in advanced security systems, home automation setups, or analytics platforms, and simplifies integration in environments that rely on custom APIs or HTTP-based solutions.

HTTPS

This solution uses the secure HTTPS protocol for encrypted communication, ensuring secure data transfer to prevent unauthorized access or data breaches. It is ideal for sensitive applications requiring confidentiality and is commonly implemented in modern, secure network environments.

Event server ✕

Server name
MAIL SERVER

Server type
E-mail ▾

Sender email address
sender@vivotek.com ✕

Recipient email address
recipient@vivotek.com ✕

Server address
10.1.1.1

User name
User name
root

Password
..... 🔒

Server port
25

This server requires a secure connection

Test Save Cancel

Event

Steps to configure an Event server

Step 1. Click the + Add button to add a new server.

Step 2. In the popup window, choose the type of server you want to configure:

Email: For sending event notifications via email.

FTP: For uploading event-related files (e.g., snapshots or videos) to an FTP server.

SFTP: Similar to FTP but uses encrypted file transfer for added security.

HTTP: For sending HTTP requests to a third-party system with event information.

HTTPS: Similar to HTTP but uses a secure communication protocol.

Step 3. Click Next to proceed with the server-specific configuration.

Step 4. Depending on the server type selected, fill in the required fields:

Email Server:

SMTP Server: Enter the SMTP server address (e.g., smtp.example.com).

Port: Specify the port (e.g., 25, 465, or 587 depending on the SMTP configuration).

Authentication: Enable and enter the username and password for the email account.

Sender Email Address: Enter the "From" address for email notifications.

Recipient Email Address: Enter the recipient's email address for receiving notifications.

FTP Server:

FTP Server Address: Enter the IP address or domain name of the FTP server.

Port: Default is 21 (adjust if needed).

Username and Password: Enter credentials to authenticate with the FTP server.

Folder Path: Specify the folder where files should be uploaded.

SFTP Server:

Similar to FTP, but ensure the SFTP protocol is supported, and credentials are entered securely.

HTTP Server:

Server URL: Enter the full URL of the HTTP server (e.g., http://example.com/api/event).

HTTPS Server:

Same as HTTP but ensure the server URL starts with "https://".

Note:

Upload and configure certificates if required for secure communication.

Step 5. Click the Test button to verify that the camera can successfully connect to the server.

Step 6. After a successful test, click "Save" to store the server configuration, and the new server will appear in the Event Server list.

Event

Step 7. Link the Server to an Event

Navigate back to the Event tab.

Create a new event or edit an existing one.

Select the configured server under the Event Server section.

Define the actions and media to be sent to the server when the event is triggered.

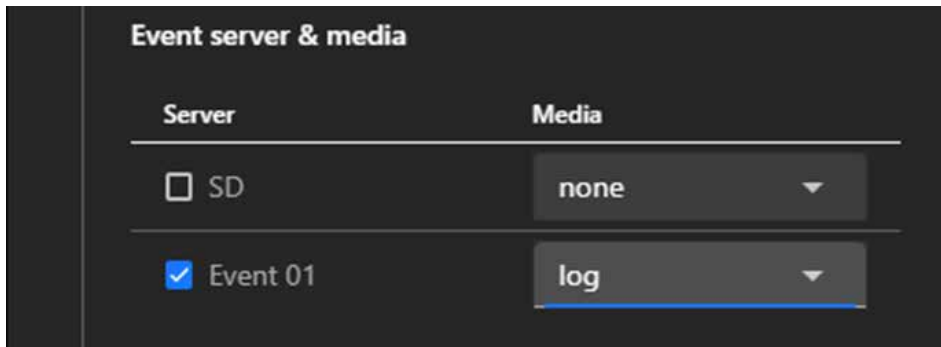

Note:

Use strong and unique passwords for server authentication to enhance security. For HTTPS and SFTP, ensure certificates and encryption settings are correctly configured. Regularly monitor and test the server connection to ensure reliable event handling.

• Event media

The Event Media settings offer a powerful and flexible media management solution, enabling users to quickly generate, store, and transmit media files during events. This meets the needs for real-time monitoring, event recording, and evidence preservation, further enhancing the efficiency and reliability of surveillance systems. The main functions and purposes of these servers are as follows:

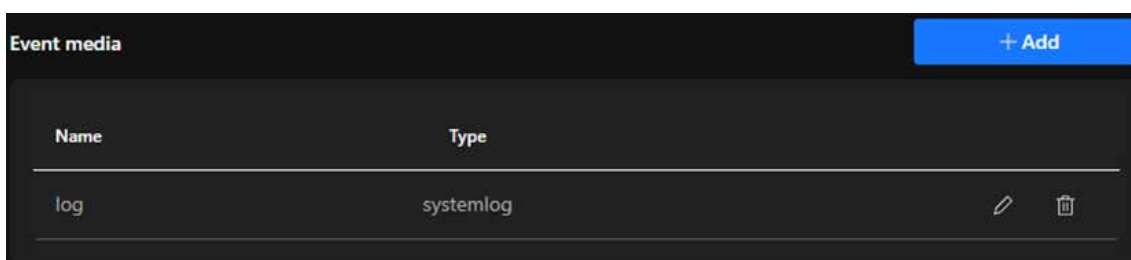

Snapshot

Captures a still image at the moment the event is triggered, providing a quick visual representation of the event that is useful for reviewing specific moments or identifying key elements such as faces or objects.

Video clip

Records a short video segment before, during, and after the event is triggered, offering detailed context and a dynamic view of the event to help users thoroughly analyze incidents such as the movement of individuals or objects.

Event

System log

Records textual data about the event, including the type of event, time, and related system activity, providing a chronological record for audits and troubleshooting while being useful for monitoring system performance and identifying anomalies.

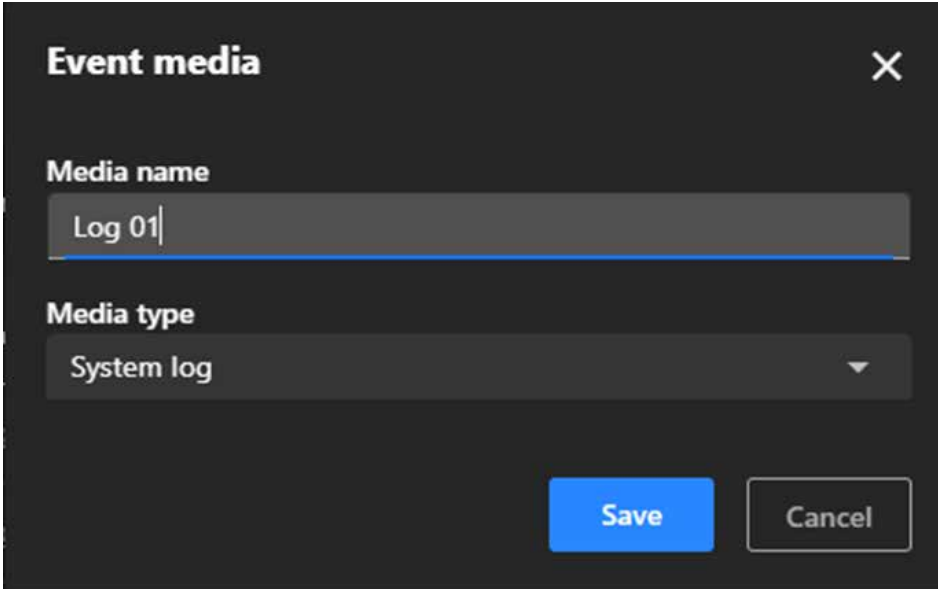

Steps to configure an Event server

Step 1. Click the + Add button to create a new media configuration.

Step 2. Enter a descriptive name for the media in the Media Name field

Step 3. Select Media Type

Choose one of the following media types from the dropdown menu:

Snapshot: Captures a still image.

Video Clip: Records a short video clip.

System Log: Logs textual data about the event.

Step 4. Configure Media-Specific Settings

Snapshot:

Source: Select the video stream from which snapshots will be taken.

Pre-Event Buffer (seconds): Define how many seconds before the event to capture snapshots.

Post-Event Buffer (seconds): Define how many seconds after the event to continue capturing snapshots.

Custom Image Frequency (frames/second): Set the frequency for capturing images (e.g., 1 frame per second).

File Name Prefix: Enter a custom prefix for snapshot filenames.

Optionally, enable the checkbox to add a date and time suffix to filenames for better organization.

Note:

The resolution setting may affect the maximum number of snapshots that can be taken. Please refer to the Video & Audio > Video > Steam page for more information.

Event

Video clip:

Source: Select the video stream to record from.

Pre-Event Recording (seconds): Define how many seconds before the event the recording should start.

Maximum Duration (seconds): Set the maximum length of the video clip (e.g., 5 seconds).

Maximum File Size (KB): Specify the maximum file size for the video clip.

File Name Prefix: Enter a custom prefix for video filenames for easy identification.

System Log:

This media type will record event-related data such as event type, time, and associated system activity.

Step 5. After configuring the settings, click “Save” to finalize the media configuration, which will then appear in the Event Media list.

Step 6. Link Event Media to an Event.

Navigate to the Event tab.

Create a new event or edit an existing one.

In the event settings, select the configured media under the Event Media section.

This ensures the configured media (e.g., snapshots, video clips, or system logs) will be generated when the event is triggered.

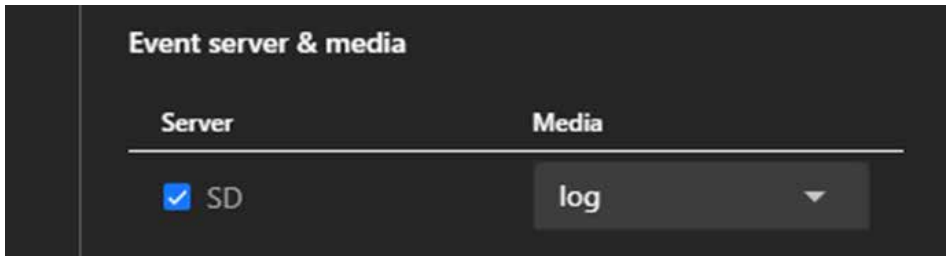

Recording

Maximize Surveillance and Storage with Tailored Recording Settings

The Recording settings empower users to customize their surveillance experience with precision and efficiency. By offering flexible scheduling, event-based triggers, and multiple storage options, these settings ensure that critical footage is captured while optimizing storage usage. Whether you need 24/7 monitoring or recordings triggered by specific events like motion or sound, the system adapts seamlessly to your needs. With the ability to store recordings locally on an SD card or on a network drive, users can ensure data security and accessibility. This customizable approach simplifies management, enhances security, and provides peace of mind, making it a vital feature for any surveillance setup.

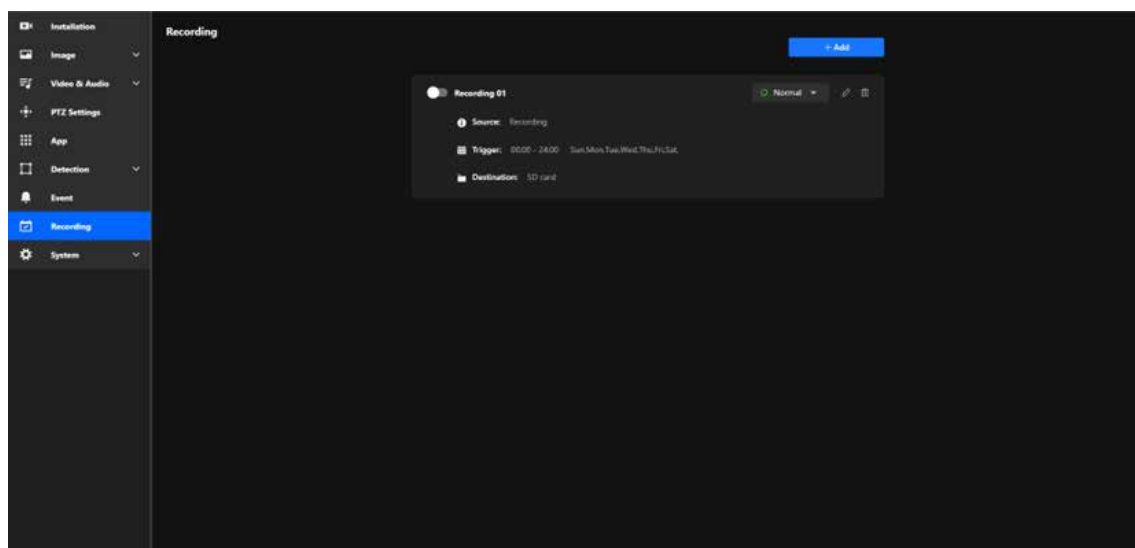

Key purpose of Recording:

Surveillance and Security

Ensures critical areas are monitored and video evidence is captured, whether continuously or based on events.

Event Investigation

Allows users to review recordings to investigate incidents or analyze activities.

Efficient Storage Management

By setting specific schedules and triggers, unnecessary recordings are minimized, conserving storage space.

Flexibility for Different Scenarios

Accommodates various recording needs, such as round-the-clock monitoring or selective recording based on motion detection or specific timeframes.

Backup and Data Accessibility

Ensures recordings are stored securely and can be accessed as needed, either from local SD cards or networked storage solutions.

Recording

Steps to configure Recording

Recording settings [X]

Recording name
Recording 01

With adaptive recording

Source
Recording

Trigger
Schedule recording
Always

Destination
SD

Because the camera has detected the absence of SD card, the settings cannot be updated. Go to check Storage

Save Cancel

Step 1. Click the +Add button to open the Recording Settings panel.

Step 2. In the **Recording name** field, type a descriptive name for this recording schedule.

Step 3. Check the **With adaptive recording** box if needed.

Step 4. Under **Source**, choose the appropriate **media profile** from the dropdown menu. Media profiles are predefined configurations in the **Video & Audio** settings of the camera.

Step 5. Under **Trigger**, select one of the following options:

- **Schedule recording**

Records based on a predefined time schedule. This is the most commonly used option for continuous or time-based recording. After selecting Schedule recording, configure the time interval:

- **Always:** Records continuously, 24/7.
- **Custom Schedule:** Set specific time frames (e.g., weekdays from 9:00 AM to 6:00 PM).

- **Network fail**

Triggers recording only when the camera detects a network failure. This ensures footage is recorded locally on the SD card when network connectivity is interrupted, providing a fail-safe mechanism.

Recording

Step 6. Under Destination, select where the recordings will be stored:

SD

Save recordings locally on the SD card inserted in the camera. This option is ideal for standalone setups or when local storage is sufficient.

NAS

Save recordings to a Network Attached Storage device. This is useful for centralized storage and easier management of video data, especially in larger surveillance systems.

Note:

If an SD card is not detected or improperly installed, a warning message will appear. Ensure an SD card is inserted or configure the NAS settings before proceeding.

Step 7. Once all fields are configured, click Save to apply the settings.

With adaptive recording

Adaptive Recording is an intelligent feature designed to optimize surveillance efficiency by dynamically adjusting the video frame rate based on real-time events. By reducing bandwidth and storage usage during routine monitoring and ensuring high-quality video during critical events, Adaptive Recording enhances both system performance and resource management. Its primary purposes are:

Bandwidth and Storage Optimization:

During normal monitoring, the system reduces bandwidth consumption and storage usage by only sending I-frame data.

Enhanced Event Recording:

When an alarm is triggered, the frame rate increases to the full frame rate to capture critical moments in high quality.

Resource Efficiency:

The system optimizes frame rate usage based on actual needs, ensuring efficient use of network and storage resources without compromising performance.

How does Adaptive Recording achieve the above purposes?

1. Dynamic Frame Rate Adjustment:

When Adaptive Recording is enabled, the camera dynamically adjusts the frame rate based on alarm triggers, such as motion detection, DI devices, or manual triggers.

When an alarm is triggered:

The camera records the full frame rate streaming data to ensure high-quality video for critical events.

When no alarm is triggered:

The camera only sends Intra frame (I-frame) data during normal monitoring to minimize bandwidth and storage usage.

Recording

2. Frame Rate Control:

No Alarm Trigger:

JPEG mode: 1 Intra frame (I-frame) per second.

H.264 mode: Records Intra frame (I-frame) only.

Alarm Trigger:

Automatically increases to the configured full frame rate.

3. Frame Period Limitation:

If the Intra frame (I-frame) period is greater than 1 second in the Video & Audio > Video > Stream page, the firmware will automatically reduce it to 1 second when Adaptive Recording is enabled.



System

The System acts as a comprehensive management hub designed for configuring and monitoring the device. It offers essential tools to manage the camera's system information, network configurations, user accounts, storage solutions, and maintenance tasks. Its core aim is to ensure secure and efficient device operation by enabling features like firmware updates, log analysis, and system diagnostics. Additionally, it improves user experience through customizable themes and streamlines data management by organizing storage and file handling. This category plays a vital role in maintaining optimal camera performance and ensuring its seamless integration into a networked environment.

Centralized Management for System Monitoring and Camera Configuration

The Device item serves as a centralized interface for monitoring and configuring the essential system information, operational status, and hardware settings of the camera. Its primary purpose is to provide users with real-time insights into system performance (CPU, memory, and storage), enable easy identification and management of the device through network and hardware details, ensure accurate time synchronization for recordings and logs, and facilitate integration with external devices through LED and DIDO controls. Overall, it enhances the camera's manageability, performance monitoring, and operational precision in a user-friendly manner.

The Device item features four functional cards covering the camera's operational status, basic device information, system time synchronization, and interaction with external devices. Its main purposes are as follows:

- **Real-time Monitoring**
Helps users track resource usage and storage capacity of the camera.
- **Identification and Management**
Facilitates easy identification and network management through basic device information.
- **Time Synchronization**
Ensures the accuracy of recording files and event logs.
- **External Device Integration**
Enables interaction with external devices to expand functional applications.

System

These functions are designed to enhance the camera's usability, operational flexibility, and integration capability with other devices.

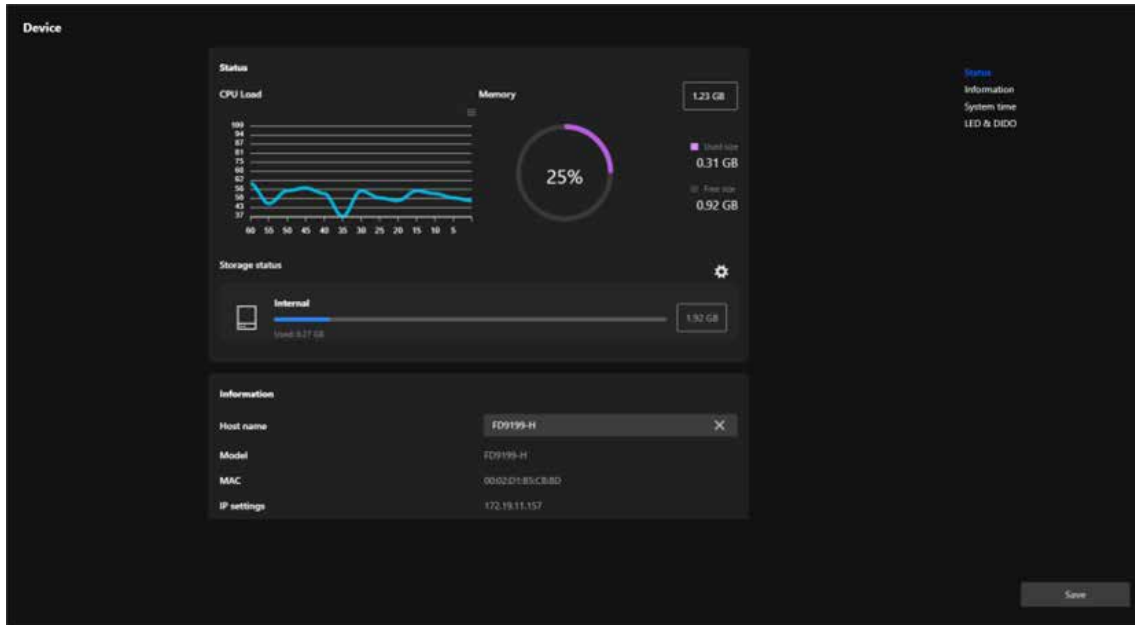

System

Status

The Status card serves as a real-time dashboard for monitoring the camera's operational performance. By providing detailed insights into CPU, memory, and storage usage, it helps users maintain optimal device performance, ensure system stability, and proactively address resource management needs.

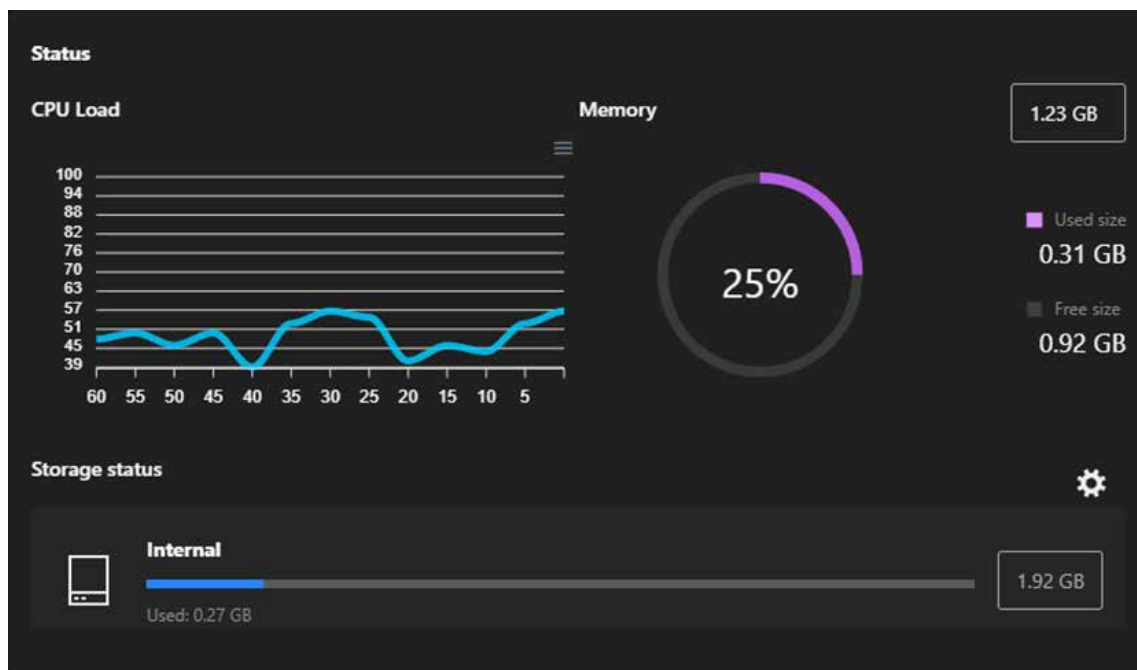

- **CPU Load**

Displays the real-time CPU usage of the camera as a line graph, showing fluctuations over time. Helps users monitor processor load trends and identify potential performance issues.

- **Memory**

A circular graph visualizes the memory usage, including: Total memory capacity, Used memory and Available memory.

Detailed figures for used and free memory are shown for precise monitoring.

- **Storage Status**

Displays the status of internal storage, including: Total storage capacity, Used storage space and Available storage, represented by a progress bar for clear visualization.

Includes options for further storage management via the gear icon.

System

Information

The Information card provides essential details for identifying, configuring, and maintaining the camera. It simplifies network management, ensures the camera is up to date, and provides quick access to critical device information, aiding in efficient management and troubleshooting.

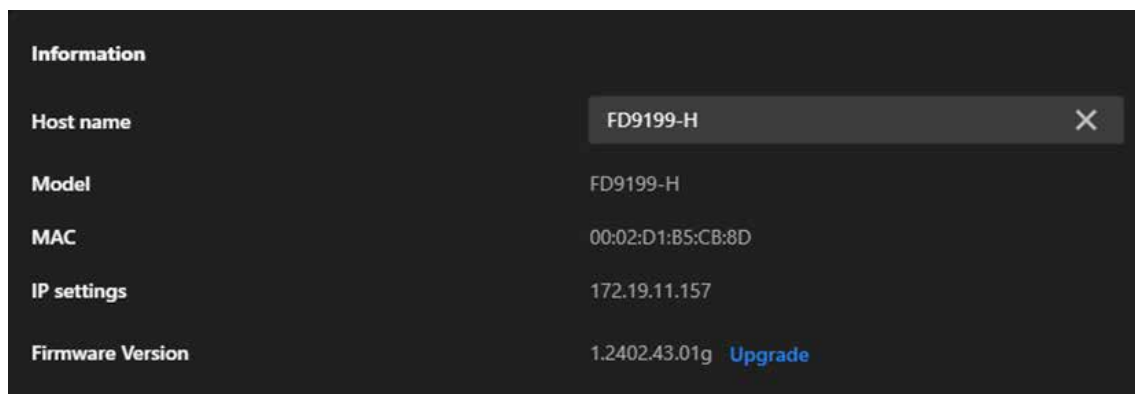

The screenshot shows a dark-themed 'Information' card with the following details:

Information	
Host name	FD9199-H
Model	FD9199-H
MAC	00:02:D1:B5:CB:8D
IP settings	172.19.11.157
Firmware Version	1.2402.43.01g Upgrade

- **Host Name**
Displays the camera's unique name.
Can be edited by the user to customize and identify the camera more easily within a network.
- **Model**
Shows the camera's model number.
Helps in identifying the specific device for maintenance or troubleshooting.
- **MAC Address**
Displays the camera's unique MAC address.
Useful for network diagnostics, device identification, or IP reservation purposes.
- **IP Settings**
Shows the camera's current IP address.
Allows users to confirm the network connectivity and configuration.
- **Firmware Version**
Displays the current firmware version installed on the camera.
Includes an Upgrade option for users to update the firmware, ensuring access to the latest features, bug fixes, and security improvements.

System

System Time

The System Time card is essential for ensuring that the camera's time is accurate and synchronized with its operating environment. By offering flexible configuration options, it supports reliable event tracking, seamless system integration, and precise log management, enabling efficient and consistent monitoring in various setups.

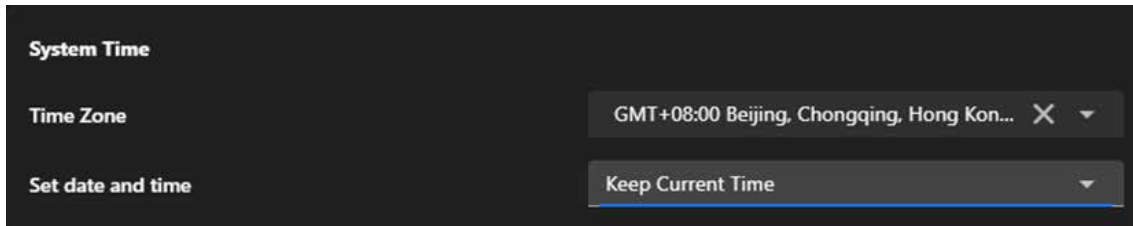

- **Time Zone**

Allows users to select the time zone based on the camera's location (e.g., GMT+08:00 Beijing, Chongqing, Hong Kong).

Ensures the camera's time aligns with the local time for accurate recording and event logging.

- **Set date and time**

Offers four options for configuring the camera's time:

- Keep Current Time**

Retains the existing time configuration on the camera without changes.

- Synchronize with PC**

Matches the camera's time to the time on the connected computer, providing a quick and convenient way to set the time.

- Manually**

Enables users to manually set the date and time, suitable for specific use cases requiring custom time settings.

- Synchronizing with NTP Server**

Synchronizes the camera's time with a Network Time Protocol (NTP) server to maintain accurate, automated time updates.

System

LED & DIDO

The LED & DIDO card serves as a bridge for the camera's interaction with its environment. By controlling the LED indicator and managing the digital input/output interfaces, it allows the camera to integrate seamlessly with external devices, enhancing its functionality and supporting a wide range of automation and monitoring applications.

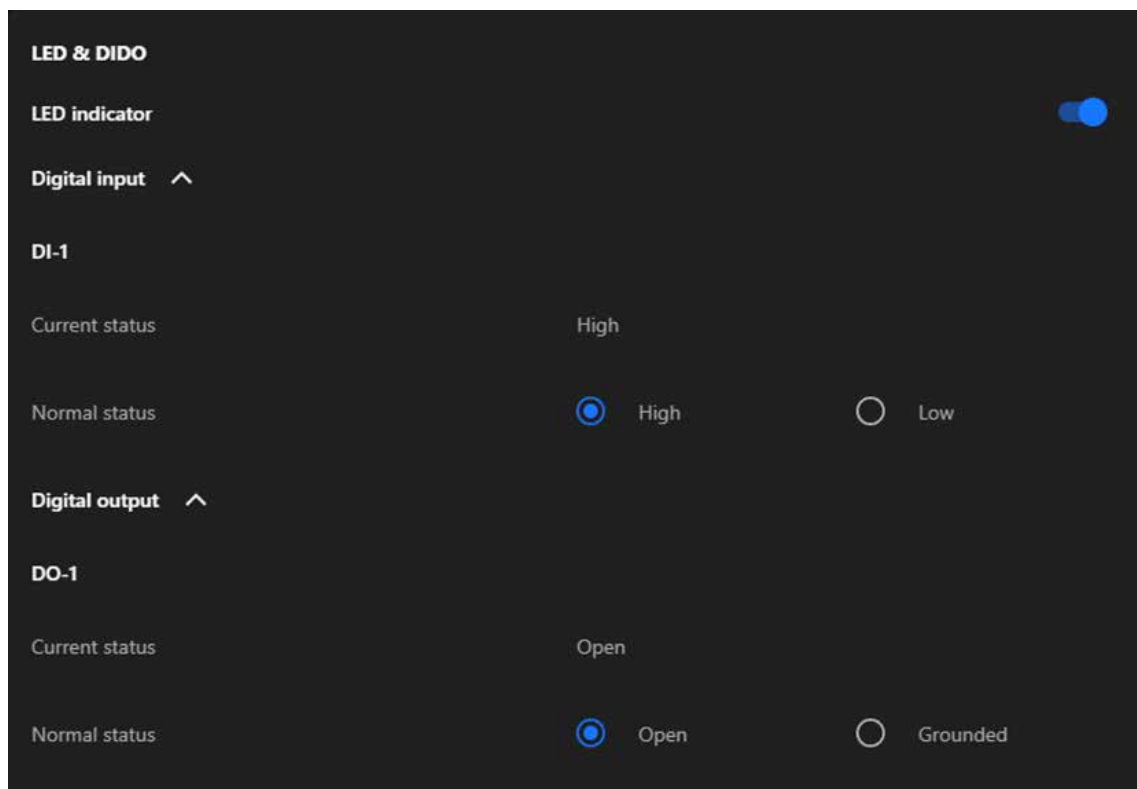

- **LED Indicator**

A toggle switch to enable or disable the camera's LED indicator.

When enabled, the LED provides visual feedback for the camera's operational status (e.g., power on, recording, or activity detection).

- **Digital input**

- **DI-1 Current status**

Displays the real-time status of the digital input (e.g., High or Low).

- **DI-1 Normal status**

Allows the user to configure the expected normal state for the digital input (either High or Low). Used for integrating external sensors (e.g., motion detectors or alarms).

System

- **Digital output**

- DO-1 Current status**

- Shows the current state of the digital output (e.g., Open or Grounded).

- DO-1 Normal status**

- Lets the user define the normal state for the digital output (either Open or Grounded). Used for triggering external devices (e.g., alarms, lights, or actuators).

- Note:**

- High/Low in DI**

- Reflects the input signal received from external devices, used for monitoring the status of sensors or triggers.

- Open/Grounded in DO**

- Controls the output signal sent to external devices, used to activate or deactivate connected equipment such as alarms or actuators.

- For detailed installation and configuration instructions, please refer to **Appendix A: DI/DO Configuration Guide**.

System

Configure and Secure Your Camera's Network Connection for Seamless Communication

The Network item provides comprehensive tools for configuring the camera's network connectivity, ensuring reliable communication, remote access, and secure integration with other devices and systems. This configuration is critical for enabling real-time monitoring, remote management, and data transmission over various network infrastructures.

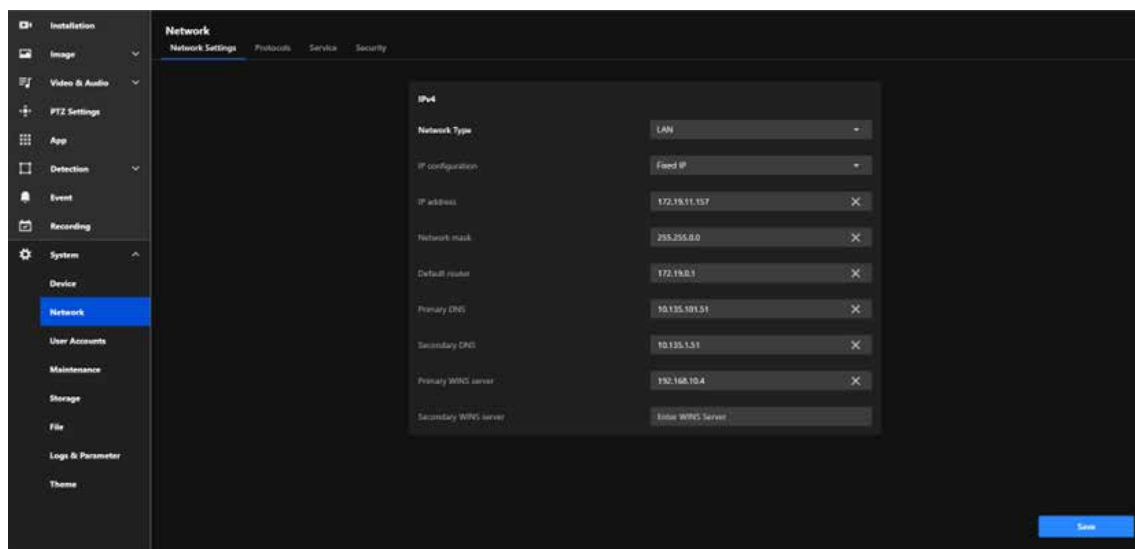

The main functional purposes are as follows:

- **Network Integration**

Allows the camera to connect to local networks or the internet through proper IP settings, enabling remote access and monitoring.

- **Customized Configuration**

Provides flexible network parameter settings (e.g., static or dynamic IP) to ensure compatibility with various network environments.

- **Reliable Communication**

Ensures seamless communication with external systems (e.g., NVRs or cloud platforms) through proper configuration of gateways, DNS, and protocols.

- **Security**

Supports secure connections and access controls to protect the camera and its data from unauthorized access or threats.

- **Efficient Monitoring and Maintenance**

Facilitates network troubleshooting and diagnostics using tools like WINS and DNS settings to ensure continuous operation.

System

Network Settings

By providing detailed configuration options for both IPv4 and IPv6, the Network Settings tab ensures the camera can seamlessly connect to and operate within diverse and complex network environments.

IPv4

The IPv4 card plays a vital role in setting up the camera's network configuration and ensuring effective communication. It facilitates dependable connectivity, enables both local and remote access, and allows the camera to integrate effortlessly into IPv4-based networks. This configuration is crucial for maintaining stable and efficient performance across diverse networking environments.

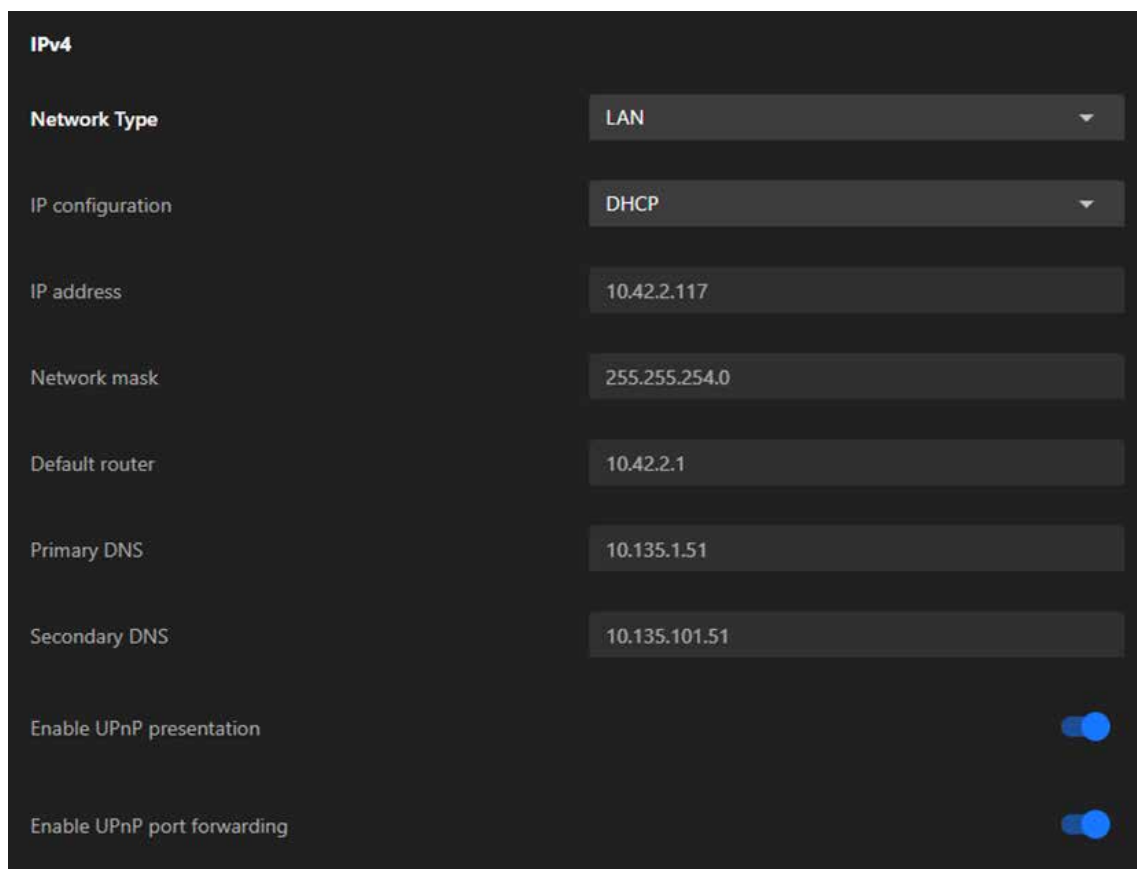

The screenshot shows the IPv4 configuration interface with the following settings:

Setting	Value
Network Type	LAN
IP configuration	DHCP
IP address	10.42.2.117
Network mask	255.255.254.0
Default router	10.42.2.1
Primary DNS	10.135.1.51
Secondary DNS	10.135.101.51
Enable UPnP presentation	Enabled
Enable UPnP port forwarding	Enabled

System

IPv4

- **Network Type**

Allows the user to select the type of network connection:

LAN	A standard wired network connection, typically used when the camera is connected to a local network through Ethernet.
PPPoE(Point-to-Point Protocol over Ethernet)	A protocol used for direct internet connections, often requiring authentication with a username and password from the Internet Service Provider (ISP). It's commonly used in DSL networks or when the camera needs to connect directly to the internet without a router.

- **IP Configuration**

Provides two configuration options:

DHCP	Dynamically assigns an IP address to the camera using a network DHCP server, suitable for networks with automated address assignment.
Fixed IP	Assigns a static IP address to the camera for consistent and reliable identification on the network.

- **IP Address**

Displays or sets the IPv4 address of the camera, which serves as the unique identifier for the camera within the network.

- **Network Mask**

Defines the subnet mask, which determines the range of devices that can directly communicate with the camera.

- **Default Router**

Specifies the default gateway for directing network traffic beyond the local subnet, such as accessing the internet or external servers.

- **Primary and Secondary DNS**

Configures DNS servers to resolve domain names into IP addresses, enabling features like remote access using hostnames instead of IP addresses.

- **Enable UPnP Presentation**

The option allows the camera to advertise itself on a network that supports Universal Plug and Play (UPnP). When enabled, the camera can be automatically discovered by compatible devices or software (such as network video recorders or VMS) without manual IP input. This simplifies device management, especially in dynamic network environments.

System

- **Enable UPnP Port Forwarding**

When this option is enabled, the camera will attempt to automatically configure port forwarding rules on a UPnP-enabled router. This makes the camera accessible from outside the local network (e.g., via the internet) without requiring manual router configuration.

System

IPv6

The IPv6 card in the Network Settings tab equips the camera with the ability to operate in next-generation networks, supporting automatic or manual IP address assignment, subnet configuration, and domain name resolution. This ensures the camera is ready for modern and future network environments, providing enhanced connectivity and adaptability.

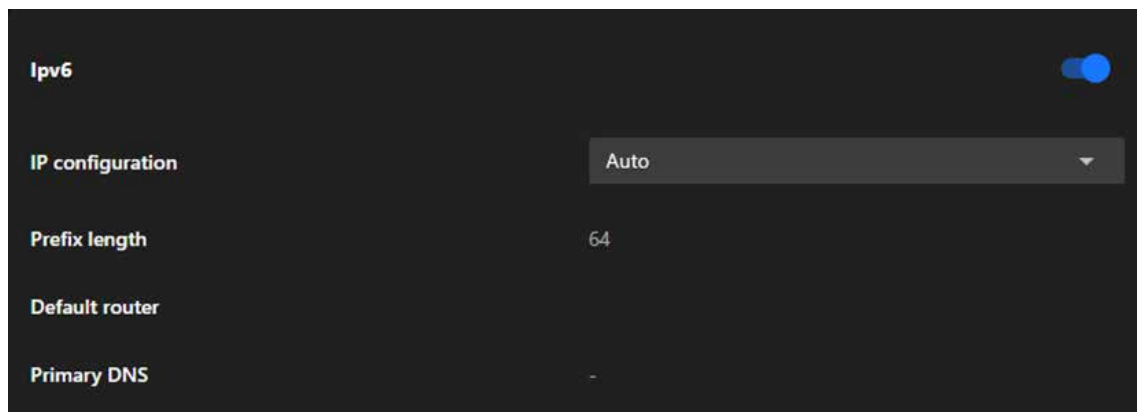

- **IP Configuration**

Allows the user to select how the IPv6 address is assigned:

Auto	Automatically obtains an IPv6 address using SLAAC (Stateless Address Autoconfiguration) or DHCPv6, depending on the network setup.
Manual	Enables manual input of a static IPv6 address if required.

- **Prefix Length**

Specifies the subnet prefix length, which determines the size of the subnet and the range of addresses that can communicate directly with the camera. A prefix length of 64 is common in IPv6 configurations.

- **Default Router**

Configures the default gateway for the camera's outgoing traffic to external networks, ensuring communication beyond the local IPv6 subnet.

- **Primary DNS**

Allows the user to specify the primary DNS server to resolve domain names into IP addresses in IPv6 networks.

System

Protocols

The Protocols tab is designed to configure various communication protocols that enable the camera to interact with other devices, systems, and networks. It includes five key protocol cards: HTTP & HTTPS, RTSP, SIP, SNMP, and Bonjour, each serving specific purposes for communication, streaming, and network discovery.

HTTP & HTTPS

The HTTP & HTTPS card is essential for configuring secure and reliable web-based access to the camera. It provides the flexibility to use both encrypted (HTTPS) and unencrypted (HTTP) protocols, ensures compatibility with modern security standards, and supports redundancy and customization for a variety of deployment scenarios.

The screenshot shows a configuration panel for HTTP & HTTPS. It includes the following settings:

- Allow access through:** HTTP & HTTPS (dropdown menu)
- Http authentication:** Digest (dropdown menu)
- HTTP port:** 80 (input field with clear button)
- Secondary HTTP port:** Enabled (toggle switch) with input field 8080 and clear button
- HTTPS port:** 443 (input field with clear button)
- TLS version:** TLS v1.2 or v1.3 (dropdown menu)
- HTTPS certificate:** default certificate (dropdown menu)
- Access name:** (dropdown menu)

System

- **Allow Access Through**

Allows users to choose the protocols for accessing the camera:

HTTP only	Enables access via the unencrypted HTTP protocol.
HTTPS only	Enables access via the encrypted HTTPS protocol.
HTTP & HTTPS	Supports both protocols simultaneously for flexible access options.

- **HTTP Authentication**

Configures the authentication method for HTTP access:

Basic	A simpler method that sends plain text credentials (less secure).
Digest	A more secure method using hashed credentials.

- **HTTP Port**

Defines the primary port used for HTTP communication (default: 80).

- **Secondary HTTP Port**

Provides an additional HTTP port (e.g., 8080) for accessing the camera as a backup or alternative.

- **HTTPS Port**

Sets the port for HTTPS communication (default: 443), ensuring encrypted and secure access.

System

- **HTTPS Certificate**

Manages the digital certificate used for HTTPS communication:

- **Default Certificate**

Uses the camera's built-in certificate.

- **Access Name**

Provides options to customize or manage the camera's hostname or access URL, simplifying identification and connection.

RTSP & RTSPS

The RTSP card is designed to configure real-time video and audio streaming settings for the camera. It enables seamless integration with external systems, secure access to live feeds, and optimized network performance through multicast and quality monitoring. This makes it a critical component for deploying the camera in professional surveillance and media environments.

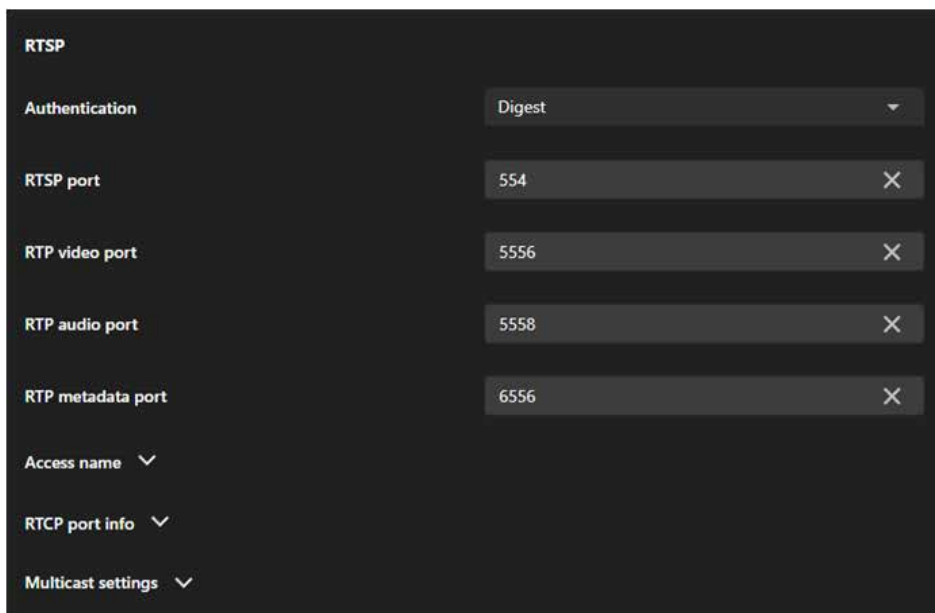

System

- **Authentication**

Configures the authentication method for RTSP access:

Disable	Disables authentication, allowing unrestricted access to RTSP streams.
Basic	Uses plain-text credentials for authentication (less secure, suitable for closed networks).
Digest	Employs hashed credentials for authentication, offering a more secure option for open or sensitive environments.

- **RTSP Port**

Specifies the port number for RTSP communication (default: 554). Used for initializing RTSP sessions between the camera and the client.

- **RTP Video Port**

Defines the port for transmitting video streams (default: 5556).

- **RTP Audio Port**

Specifies the port for transmitting audio streams (default: 5558).

- **RTP Metadata Port**

Sets the port for sending metadata (e.g., timestamps or event information) along with the video and audio streams (default: 6556).

- **Access Name**

Provides options to configure or customize the access name (URL path) for RTSP streams, simplifying access for third-party systems or users.

- **RTCP Port Info**

Configures RTCP (Real-Time Control Protocol) ports, which are used to monitor the quality of service (QoS) of the streaming session and provide feedback on issues such as packet loss or jitter.

- **Multicast Settings**

Divided into three sections: Video, Audio, and Metadata, each with specific settings.

- **Stream (for Video only)**

Specifies which video stream to multicast (e.g., Stream 1 or Stream 2).

- **IP Version**

Allows the selection of IPv4 or IPv6 for multicast traffic.

- **Multicast Address**

Assigns a unique multicast IP address for each stream (e.g., 239.x.x.x for IPv4 or FF00::/8 for IPv6).

System

- **Multicast Port**

Configures the port number for multicast streaming (e.g., 5556 for video, 5558 for audio).

- **Multicast TTL (Time-to-Live)**

Sets the number of network hops allowed for multicast packets, controlling their distribution range.

- **Transport layer security**

TLS Version

Offers options to select the encryption protocol for HTTPS:

TLS v1.2 only	For compatibility with older systems.
TLS v1.3 only	For maximum security using the latest protocol.
TLS v1.2 or v1.3	Provides flexibility by supporting both.

SIP

The SIP card is essential for configuring the camera’s two-way audio communication capabilities via the SIP protocol. It enables integration with SIP-based systems, supports real-time audio interaction, and ensures flexibility with customizable port settings, making it a critical feature for applications requiring interactive communication.

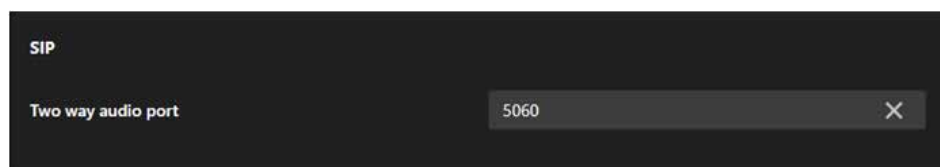

- **Two way audio port**

The Two-Way Audio Port configures the port (default: 5060) used for SIP-based audio communication, allowing the camera to transmit and receive audio streams for real-time interaction with other SIP-compatible devices.

System

SNMP

This section explains how to use the SNMP on the network camera. The Simple Network Management Protocol is an application layer protocol that facilitates the exchange of management information between network devices. It helps network administrators to remotely manage network devices and find, solve network problems with ease. The SNMP consists of the following three key components:

- **Manager**

Network-management station(NMS), a server which executes applications that monitor and control managed devices.

- **Agent**

A network-management station software module on a managed device which transfers the status of managed devices to the NMS.

- **Managed device**

A network node on a managed network. For example: routers, switches, bridges, hubs, computer hosts, printers, IP telephones, network cameras, web server, and database.

Note:

Before configuring SNMP settings on this card, please enable your NMS first.

- **Enable SNMPv1, SNMPv2c**

Select the option and enter the names of Read/Write community and Read Only community according to your NMS settings.

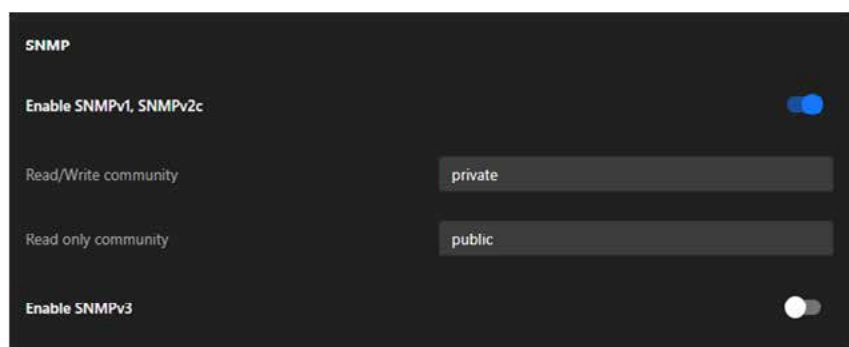

- **Enable SNMPv3**

This option contains cryptographic security, a higher security level, which allows you to set the Authentication password and the Encryption password.

- **Read/Write security name**

According to your NMS settings, choose Read/Write or Read Only and enter the community name.

- **Authentication type**

Select MD5 or SHA as the authentication method.

- **Authentication password**

Enter the password for authentication (at least 8 characters).

System

- **Encryption password**

Enter a password for encryption (at least 8 characters).

Enable SNMP trap

The SNMP Trap feature allows the camera to proactively send real-time alerts, known as traps, to an SNMP management system. Unlike regular SNMP polling where the management server queries the device periodically, traps are event-driven notifications sent immediately by the camera when specific conditions or events occur.

- **Bonjour**

To access the camera from a MAC computer, go to Safari, click on Bonjour and select the camera from a drop-down list.

You can go to Safari > Preferences to enter your user name and password, provide the root password the first time you access the camera. The camera main page will open in your browser.

System

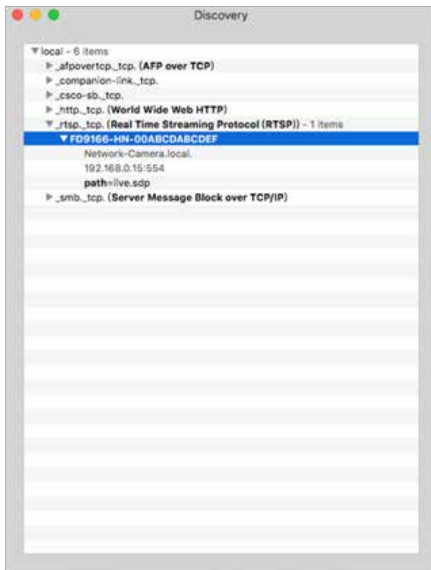

- **Discovery Utility for Bonjour Services**

In some later versions of iOS, the Bonjour option may no longer be available. To address this, you can use the Discovery utility, which serves as a replacement for the Bonjour Browser. Follow the steps below to get started:

- **Install Discovery from the Mac App Store**

Discovery is a utility that lists all Bonjour services available on your local network or Wide-Area Bonjour domains.

Previously known as **Bonjour Browser**, the updated **Discovery** utility is now distributed exclusively on the Mac App Store.

System Requirements: Discovery requires macOS 10.12 (Sierra) or later.

<http://www.tildesoft.com/files/BonjourBrowser.dmg>

- **Install Discovery for iOS**

Discovery is also available for iOS devices and can be downloaded from the App Store.

<https://itunes.apple.com/us/app/discovery-dns-sd-browser/id305441017?mt=8>

System

Service

The Service tab provides essential options for managing network services. These include enabling Dynamic Domain Name System (DDNS) for seamless remote access even with dynamic IP addresses, configuring Quality of Service (QoS) settings to prioritize camera data traffic on the network, and activating FTP or SFTP servers for secure and efficient file transfer. These features ensure reliable connectivity, enhanced data security, and improved performance, catering to diverse surveillance requirements.

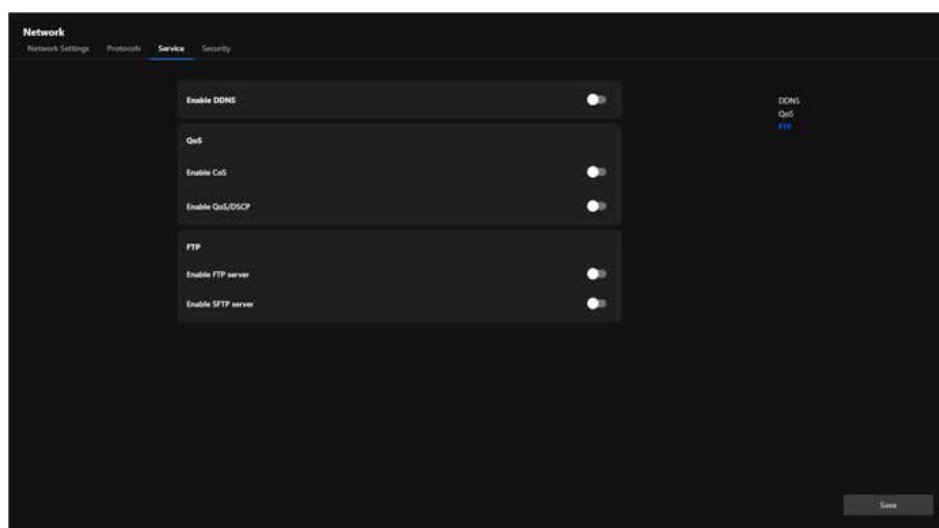

System

- **DDNS**

The card integrates with third-party DDNS services to dynamically update the domain name associated with the camera whenever its IP address changes. Users need to provide valid credentials and a registered hostname with their DDNS provider to use this feature effectively. The difference between “Dynamic” and “Custom” provider modes allows flexibility based on the user’s DDNS service plan or provider requirements.

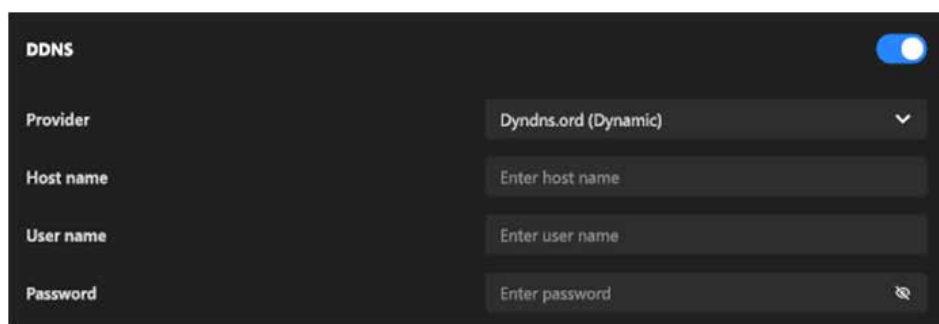

The screenshot shows a dark-themed configuration panel for DDNS. At the top left, the word "DDNS" is displayed next to a blue toggle switch that is turned on. Below this, there are four rows of configuration options: "Provider" with a dropdown menu showing "DynDNS.org (Dynamic)", "Host name" with a text input field containing "Enter host name", "User name" with a text input field containing "Enter user name", and "Password" with a text input field containing "Enter password" and a small eye icon to toggle visibility.

Enable DDNS:

Allows the user to activate or deactivate the DDNS functionality.

Provider:

A dropdown menu allows users to select the DDNS service provider, with options such as “DynDNS.org (Dynamic)” or “DynDNS.org (Custom).” The selected provider determines how the hostname and credentials are configured for the DDNS connection.

Host Name:

An input field is provided to specify the unique hostname registered with the selected DDNS provider (e.g., yourcamera.dyndns.org), which will be used for remote access to the camera.

User Name:

Input field for the account username required by the DDNS provider.

Password:

Input field for the password associated with the DDNS account. A hidden field ensures privacy during input.

System

- QoS

The QoS card allows users to flexibly configure the priority of different types of data streams based on network environment requirements. When CoS is enabled, it can integrate with VLANs, making it suitable for Ethernet networks. Enabling QoS/DSCP, on the other hand, is more appropriate for IP networks. These settings help enhance the reliability and efficiency of camera data transmission, which is particularly crucial when multiple devices share the same network.

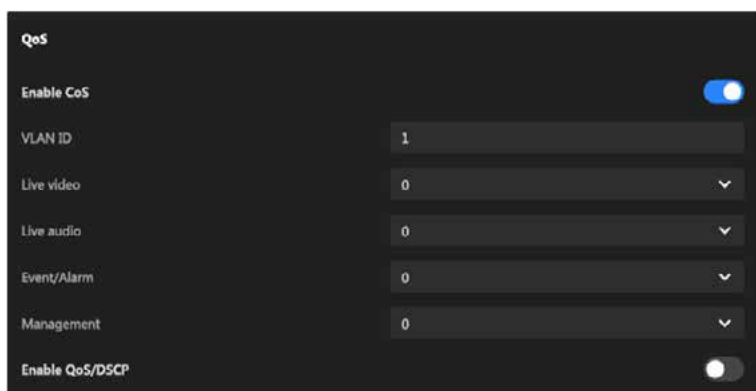

Enable CoS (Class of Service):

A toggle switch to enable or disable CoS functionality.

VLAN ID:

Specifies the VLAN tag for identifying the virtual LAN the camera is part of.

Priority settings for each data type (Live Video, Live Audio, Event/Alarm, Management):

Each data type (Live Video, Live Audio, Event/Alarm, Management) can be assigned a priority level via a 0-7 dropdown menu, where higher numbers indicate higher transmission priority. This allows for fine-grained control of traffic within an Ethernet network.

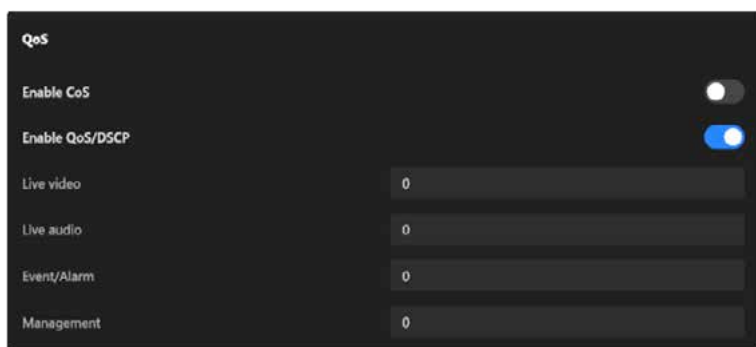

Enable QoS/DSCP (Differentiated Services Code Point):

A toggle switch to enable or disable DSCP functionality.

DSCP values for each data type (Live Video, Live Audio, Event/Alarm, Management):

Allows users to configure a DSCP value for each data type (Live Video, Live Audio, Event/Alarm, Management). These values determine the priority of the data in IP networks, ensuring proper traffic classification and efficient routing.

System

- **FTP**

The FTP card provides the flexibility to use FTP for simple and efficient file transfers or SFTP for secure, encrypted transfers, depending on the user's operational and security needs. The ability to configure the ports ensures compatibility with various network configurations. Host keys in SFTP further enhance trust and security during client-server communication. This functionality is particularly useful for automated storage or backup of surveillance data to remote locations.

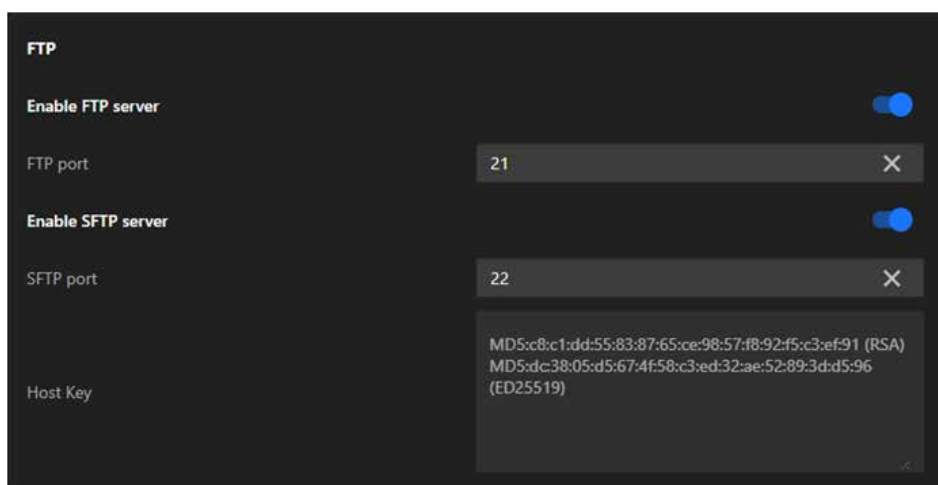

Enable FTP Server:

A toggle switch to enable or disable the FTP server functionality.

FTP Port:

Specifies the port used for the FTP service (default is 21). Users can adjust this to align with their network or security requirements.

Enable SFTP Server:

A toggle switch to enable or disable the SFTP server functionality.

SFTP Port:

Specifies the port used for the SFTP service (default is 22). Users can modify this port if needed to avoid conflicts or meet specific security policies.

Host Key:

Displays the server's host key information, including hash values (e.g., RSA and ED25519 keys). These keys are used to authenticate the server and ensure secure connections between the client and the server.

System

Security

The Security tab provides a comprehensive set of options to enhance network security. It allows users to manage certificates for encrypted communications, implement access control through IP filtering and IEEE 802.1x authentication, and restrict administrative access to specific IP addresses. By utilizing these features, users can ensure secure data transmission, prevent unauthorized access, and protect the camera in both simple and complex network environments. This tab is designed to address the security needs of modern surveillance systems and offer robust protection against potential threats.

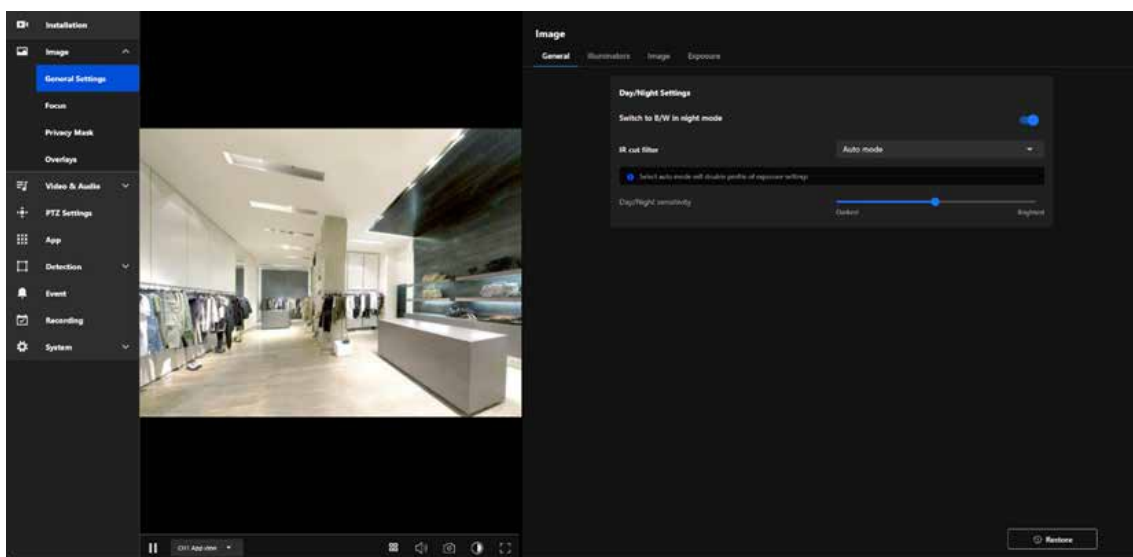

Certificate

The Certificate card focuses on providing a robust and centralized solution for managing certificates. By supporting HTTPS encryption, it ensures secure communication between the camera and external systems, safeguarding data against potential eavesdropping or tampering. The notification feature alerts users to expired certificates, helping to mitigate associated risks, while the ability to manage multiple certificates offers flexibility to accommodate various network configurations and requirements.

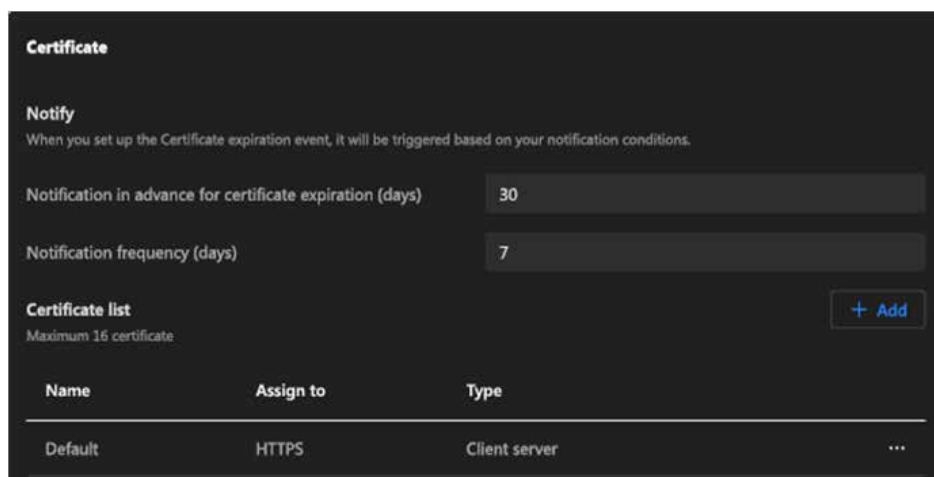

System

- **Notify:**

Configures notification settings for certificate expiration.

- **Notification in advance for certificate expiration (days):**
Sets how many days before expiration the system will send a notification.
- **Notification frequency (days):**
Specifies the frequency of repeated notifications.

- **Certificate List:**

Supports managing up to 16 certificates and displays detailed information about each certificate, including:

- **Name:**
The name of the certificate.
- **Assign to:**
The application or protocol the certificate is associated with (e.g., HTTPS).
- **Type:**
The purpose of the certificate (e.g., Client-Server).
- **Indicates the current status of each certificate, such as “Certificate expired.”**

- **Steps to add a Certificate:**

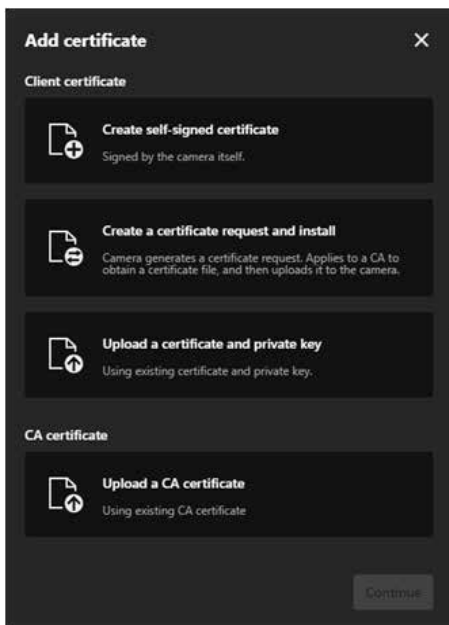

System

- **Steps to add a Certificate:**

Option 1. Create a self-signed certificate for the Client certificate.

- **Step 1.** Click "+Add" button and then pop up the "Add Certificate" window.
- **Step 2.** Select Create self-signed certificate.
- **Step 3.** Fill in the required fields, including:
 - Name: Enter a name for the certificate (e.g., "Cert 01").
 - Certificate country: Provide the country code (e.g., "TW").
 - State or province and Locality: Specify the location (e.g., "Asia").
 - Organization and Organization unit: Enter the organization details.
 - Common name: Provide the domain name (e.g., "www.vivotek.com").
 - Validity: Specify the validity period in days (e.g., "397").
- **Step 4.** Click Create to start certificate generate procedure.
- **Step 5.** A message indicating "Generated successfully" means the process is complete.

The screenshot shows a dark-themed dialog box titled "Create certificate" with a close button (X) in the top right corner. Below the title is the subtitle "Create self-signed certificate". The form contains the following fields:

- Name:** A text input field containing "Cert 01".
- Certificate country:** A text input field containing "TW".
- State or province:** A text input field containing "Asia".
- Locality:** A text input field containing "Asia".
- Organization:** A text input field containing "VIVOTEK Inc.".
- Organization unit:** A text input field containing "VIVOTEK Inc.".
- Common name:** A text input field containing "www.vivotek.com".
- Validity:** A text input field containing "397".

At the bottom of the dialog, there are two buttons: a "Back" button on the left and a "Create" button on the right.

System

- Steps to add a Certificate:

Option 2. Create a Certificate Request and Install for the Client certificate.

- Step 1. Click "+Add" button and then pop up the "Add Certificate" window.
- Step 2. Select Create a certificate request and install.
- Step 3. Fill in the required fields similar to the self-signed certificate (Name, Location, Organization, Common Name).
- Step 4. Click Create to start certificate generate procedure.
- Step 5. A message indicating "Uploaded successfully" means the certificate request is generated successfully.
- Step 6. Click "Copy certificate request" button to copy the details of the certificate request (CSR).
- Step 7. Use the copied CSR to apply for a certificate from a trusted CA, which will then provide a signed certificate file (e.g., a.crt file).
- Step 8. After receiving the signed certificate from the CA, return to the same window, click Upload file, and select the .crt file provided by the CA.
- Step 9. Click Create to complete the installation of the certificate.
- Step 10. A message indicating "Uploaded successfully" means the process is complete.

Create certificate ×

Create a certificate request and install

Name
Cert 02

Certificate country
TW

State or province
Asia

Locality
Asia

Organization
VIVOTEK Inc.

Organization unit
VIVOTEK Inc.

Common name
www.vivotek.com

Back Create

System

- Steps to add a Certificate:

Option 3: Upload a Certificate and Private Key for the Client certificate.

- Step 1. Click "+Add" button and then pop up the "Add Certificate" window.
- Step 2. Select Upload a certificate and private key.
- Step 3. Fill in the certificate name (e.g., "Cert 03").
- Step 4. Use the Upload certificate file (*.cert) and Upload private key file (*.key) options to upload the respective files.
- Step 5. Click Create to add the certificate.

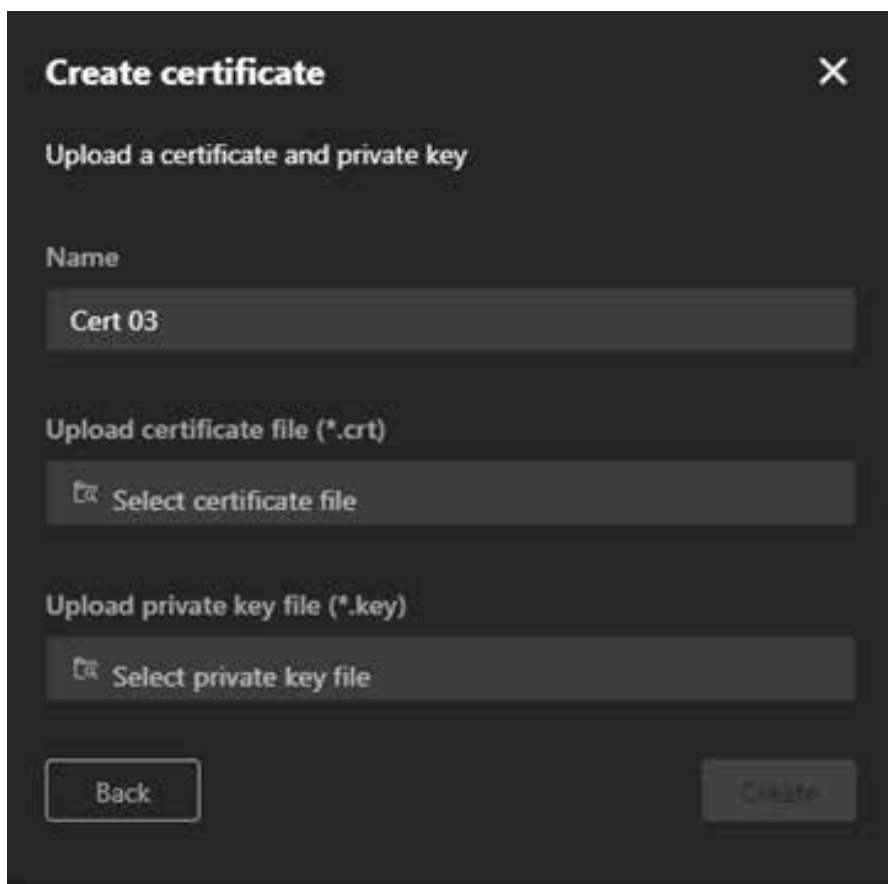

The image shows a dark-themed dialog box titled "Create certificate" with a close button (X) in the top right corner. The dialog contains the following elements:

- A header section: "Upload a certificate and private key".
- A "Name" label followed by a text input field containing "Cert 03".
- An "Upload certificate file (*.cert)" label followed by a file selection button with a folder icon and the text "Select certificate file".
- An "Upload private key file (*.key)" label followed by a file selection button with a folder icon and the text "Select private key file".
- At the bottom, there are two buttons: "Back" on the left and "Create" on the right.

System

- Steps to add a Certificate:

Option 4: Upload a CA Certificate for the CA certification

- Step 1. Click "+Add" button and then pop up the "Add Certificate" window.
- Step 2. Select Upload a CA certificate.
- Step 3. Fill in the certificate name (e.g., "Cert 04").
- Step 4. Use the Upload certificate file (*.pem) option to upload the CA certificate.
- Step 5. Click Create to finalize the process.

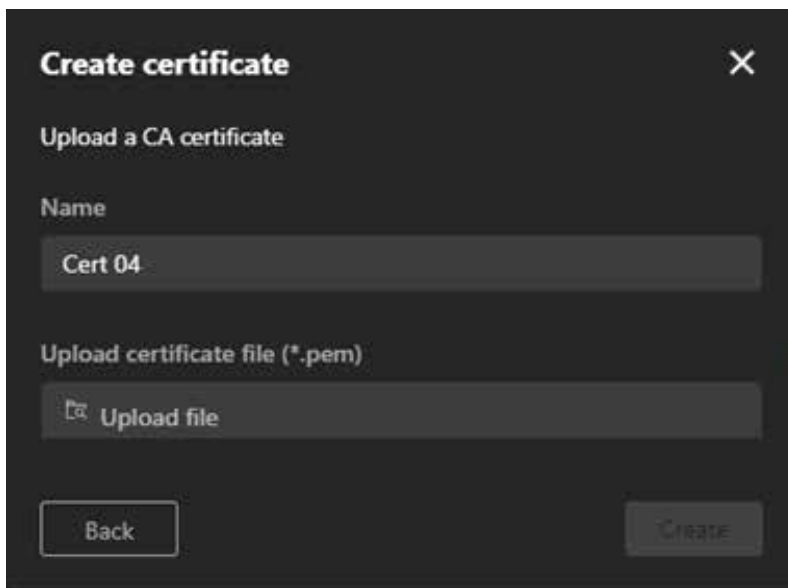

The screenshot shows a dark-themed dialog box titled "Create certificate" with a close button (X) in the top right corner. The dialog is divided into two main sections. The first section is titled "Upload a CA certificate" and contains a "Name" label followed by a text input field containing the text "Cert 04". The second section is titled "Upload certificate file (*.pem)" and contains a file upload button with a folder icon and the text "Upload file". At the bottom of the dialog, there are two buttons: "Back" on the left and "Create" on the right.

System

- Step 3. Open a new edit, paste the certificate contents, and press ENTER at the end of the contents to add an empty line.

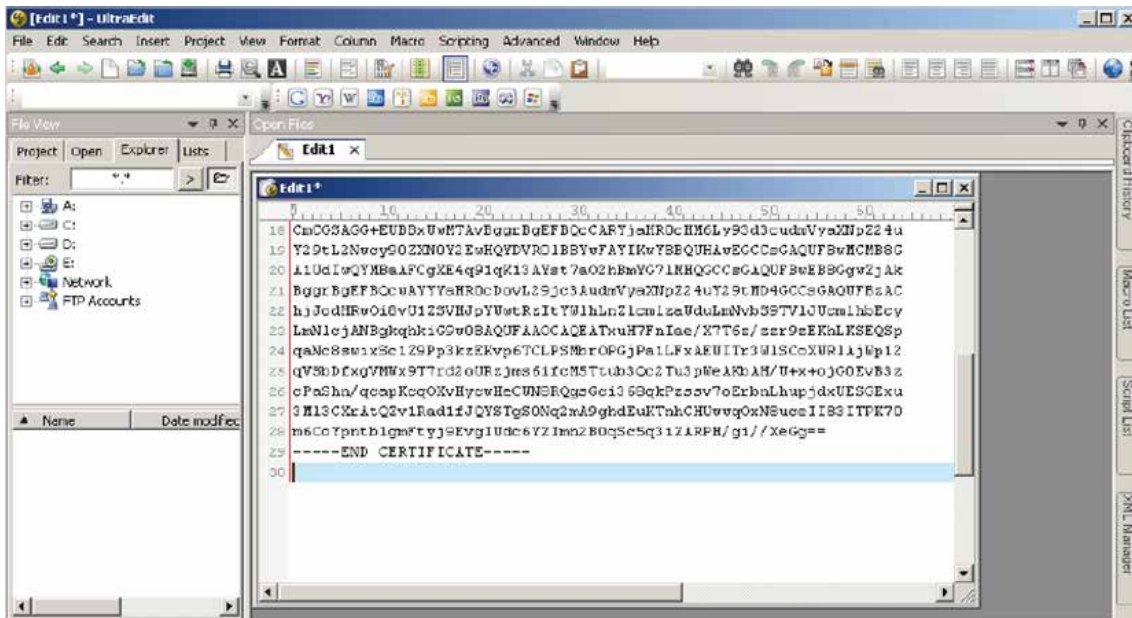

- Step 4. Convert file format from DOS to UNIX. Open File menu > Conversions > DOS to Unix.

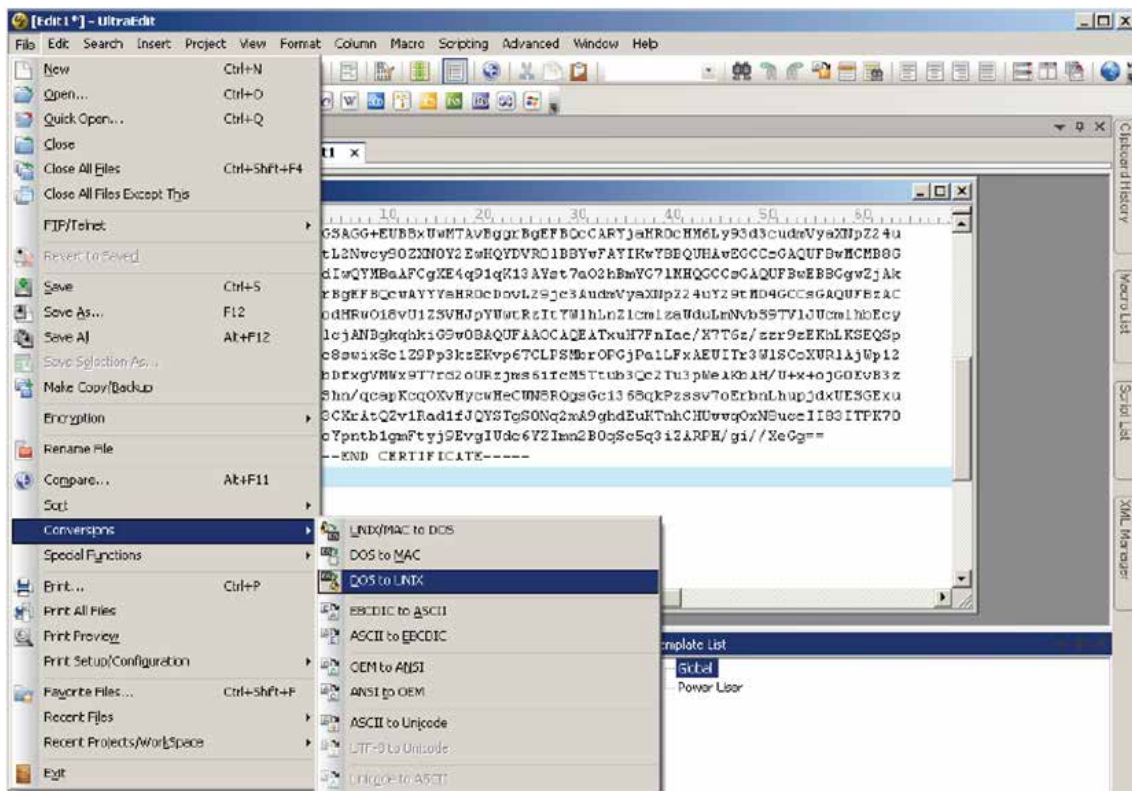

System

- Step 5. Save the edit using the “.crt” extension, using a file name like “CAcert.crt.”

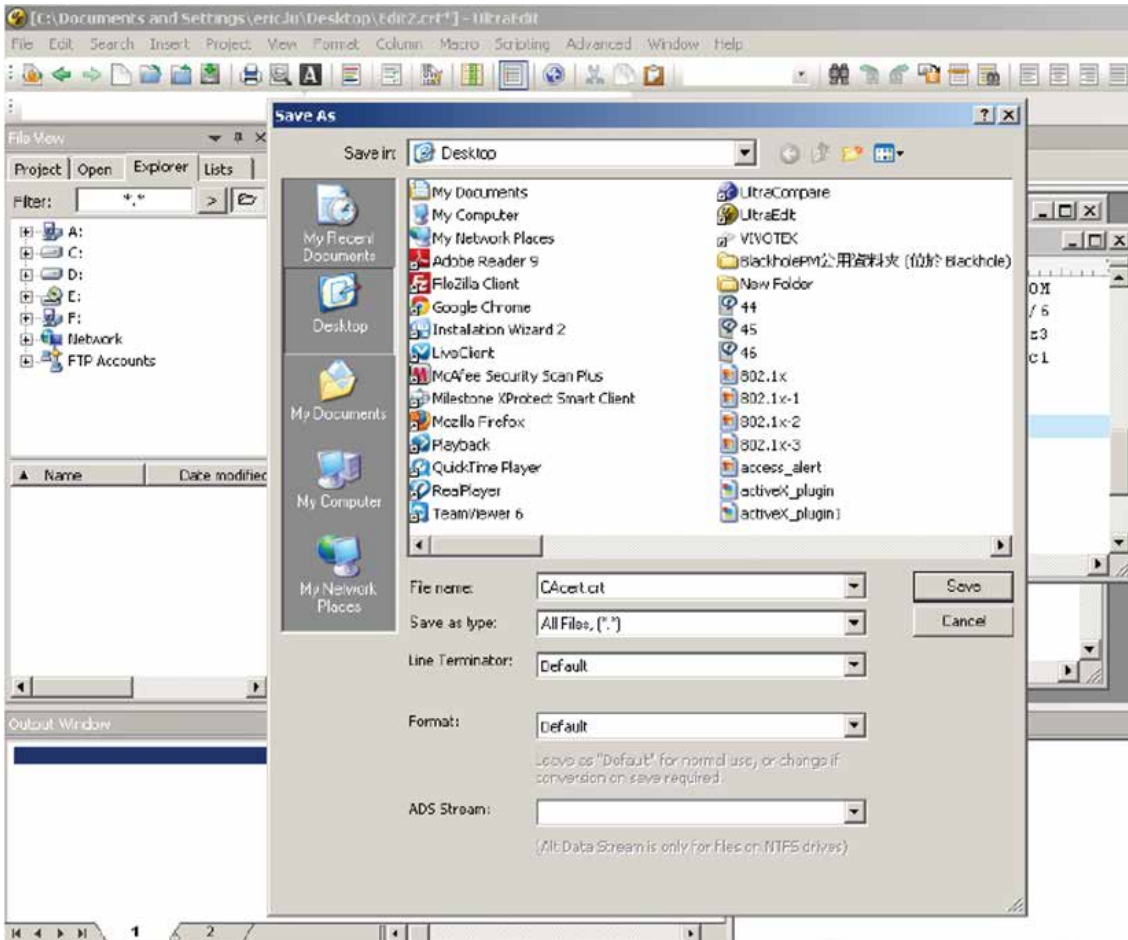

- Step 6. Return to the original firmware session, use the “More” icon > “Copy & Upload” button to locate the crt certificate file, and click Create to enable the certification.

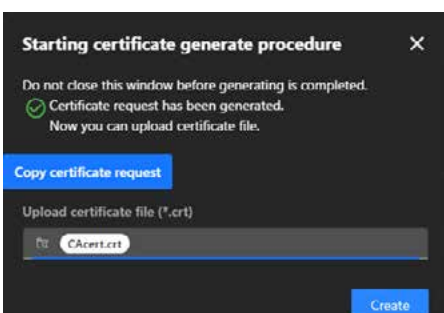
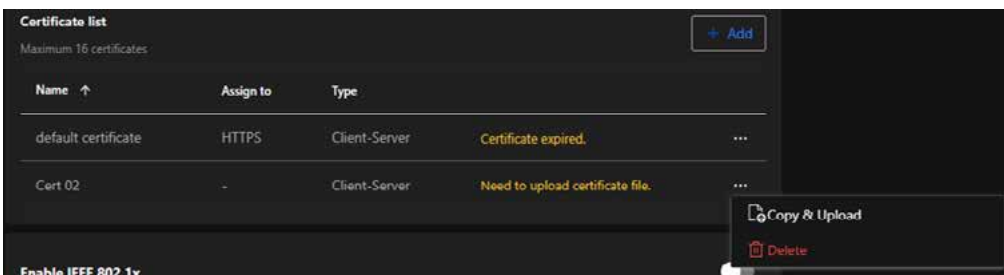

System

IEEE 802.1x

Enable this function if your network environment uses IEEE 802.1x, which is a port-based network access control. The network devices, intermediary switch/access point/hub, and RADIUS server must support and enable 802.1x settings.

The 802.1x standard is designed to enhance the security of local area networks, which provides authentication to network devices (clients) attached to a network port (wired or wireless). If all certificates between client and server are verified, a point-to-point connection will be enabled; if authentication fails, access on that port will be prohibited. 802.1x utilizes an existing protocol, the Extensible Authentication Protocol (EAP), to facilitate communication.

The components of a protected network with 802.1x authentication:



- **Supplicant:**
A client end user (camera), which requests authentication.
- **Authenticator (an access point or a switch):**
A “go between” which restricts unauthorized end users from communicating with the authentication server.
- **Authentication server (usually a RADIUS server):**
Checks the client certificate and decides whether to accept the end user’s access request.

VIVOTEK Network Cameras support two types of EAP methods to perform authentication: **EAP-PEAP** and **EAP-TLS**. Please follow the steps below to enable 802.1x settings:

- **Step 1. Before connecting the Network Camera to the protected network with 802.1x, please apply a digital certificate from a Certificate Authority (i.e., your network administrator) which can be validated by a RADIUS server.**

System

- Step 2. Connect the Network Camera to a PC or notebook outside of the protected LAN. Open the configuration page of the Network Camera as shown below. Select EAP-PEAP or EAP-TLS as the EAP method. In the following blanks, enter your ID and password issued by the CA, then upload related certificate(s).

The screenshot shows the configuration page for IEEE 802.1x. At the top, 'IEEE 802.1x' is enabled with a blue toggle switch. Below this, the 'EAP method' is set to 'EAP-PEAP' in a dropdown menu. There are three input fields: 'Identity' with the placeholder 'Enter identity', 'Password' with the placeholder 'Enter password' and a password icon, and 'CA certificat' with a dropdown menu showing 'Select one certificate'.

The screenshot shows the configuration page for IEEE 802.1x. At the top, 'Enable IEEE 802.1x' is enabled with a blue toggle switch. Below this, the 'EAP method' is set to 'EAP-TLS' in a dropdown menu. There are four input fields: 'Identity' with the placeholder 'Enter identity', 'Upload CA certificate file (.crt)' with a dropdown menu showing 'Select one certificate', and 'Upload client certificate file (.crt)' with a dropdown menu showing 'Select one certificate'.

- Step 3. When all settings are complete, move the Network Camera to the protected LAN by connecting it to an 802.1x enabled switch. The devices will then start the authentication automatically.
- Note:
The authentication process for 802.1x:
 - Step 1. The Certificate Authority (CA) provides the required signed certificates to the Network Camera (the supplicant) and the RADIUS Server (the authentication server).
 - Step 2. A Network Camera requests access to the protected LAN using 802.1X via a switch (the authenticator). The client offers its identity and client certificate, which is then forwarded by the switch to the RADIUS Server, which uses an algorithm to authenticate the Network Camera and returns an acceptance or rejection back to the switch.
 - Step 3. The switch also forwards the RADIUS Server's certificate to the Network Camera.

System

- Step 4. Assuming all certificates are validated, the switch then changes the Network Camera's state to authorized and is allowed access to the protected network via a pre-configured port.

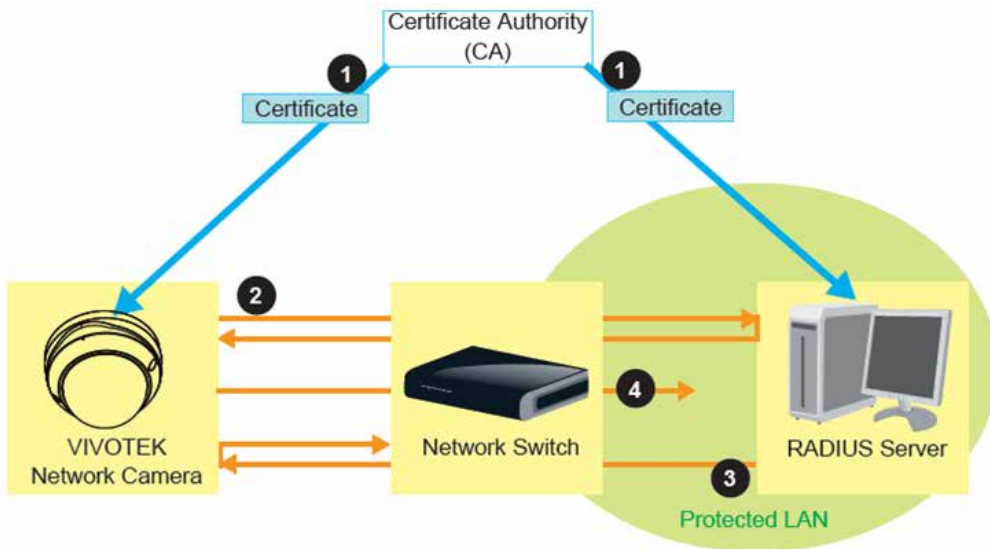

Access List

This feature is particularly useful in environments where the camera is exposed to a larger network or the internet, ensuring only trusted devices or networks have access.

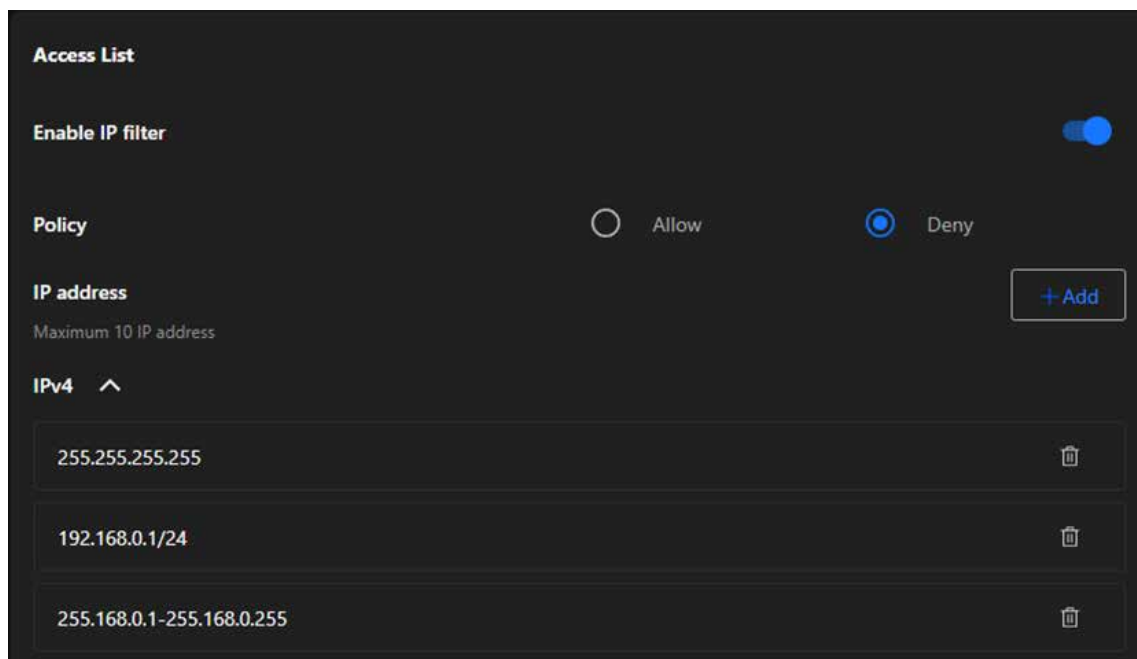

System

- **Enable IP Filter**

A toggle switch to activate or deactivate the IP filtering feature.

- **Policy**

Allow:

Permits only the specified IP addresses to access the camera. All other IPs are denied.

Deny:

Blocks the specified IP addresses from accessing the camera. All other IPs are allowed.

- **IP Address**

A section to define up to 10 IP addresses or ranges that are either allowed or denied access based on the selected policy.

- **IPv4 List**

Displays the list of configured IP addresses or ranges, and the entries can be removed using the trash bin icon next to each address. Each entry can represent:

A single IP address (e.g., 192.168.0.1).

A network IP address (e.g., 192.168.0.1/24).

A specific IP range (e.g., 255.168.0.1-255.168.0.255).

Steps to add an IP address into Access List:

Step 1. Click "+Add" button to open the "Add IP Address" window

Step 2. From the IP Type dropdown menu, choose the desired type:

IPv4: For standard IPv4 addresses or ranges.

Step 3. From the Rule dropdown menu, select one of the following options:

Single: To allow or deny a single IP address.

Network: To allow or deny access for an entire subnet.

IP Range: To define a specific range of IP addresses.

Step 4. Enter the IP Address:

Based on the selected rule, input the relevant details in the IP Address field:

For Single: Enter one IP address (e.g., 192.168.0.10).

For Network: Enter an IP address and its subnet mask.

For IP Range: Enter the starting and ending IP addresses.

Step 5. Click Save to add the IP address or range to the Access List.

System

Step 6. The new entry will now appear in the IPv4 section of the Access List.

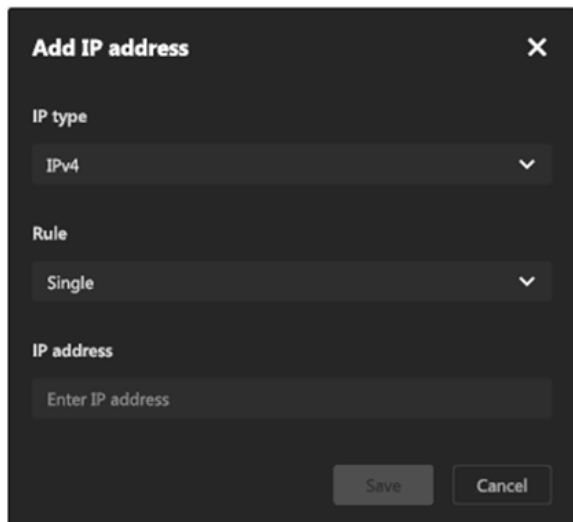

Administrator IP address

The Administrator IP address provides a simple yet effective way to secure administrative access while ensuring that authorized personnel can always manage the device, even in complex or restricted network environments.

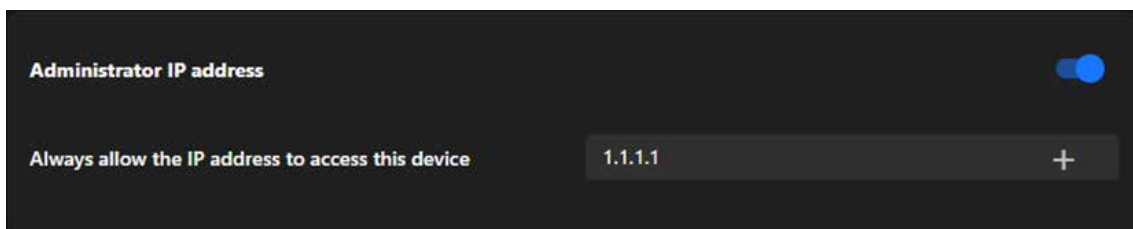

- **Always allow the IP address to access this device:**

You can check this item and add the Administrator's IP address in this field to make sure the Administrator can always connect to the device.

Steps to set the Administrator IP address:

Step 1. Input the Trusted IP Address:

Enter the IP address that should always have administrative access.

Step 2. Enable the Feature:

Turn on the toggle switch to activate the setting.

Step 3. Save Changes:

Ensure the configuration is saved for the setting to take effect.

System

Miscellaneous

The **Miscellaneous** card in the VIVOTEK camera's settings provides additional security-related options to enhance the safety and usability of the device. It focuses on protecting against cross-site request forgery (CSRF) attacks and managing session timeouts for user accounts.

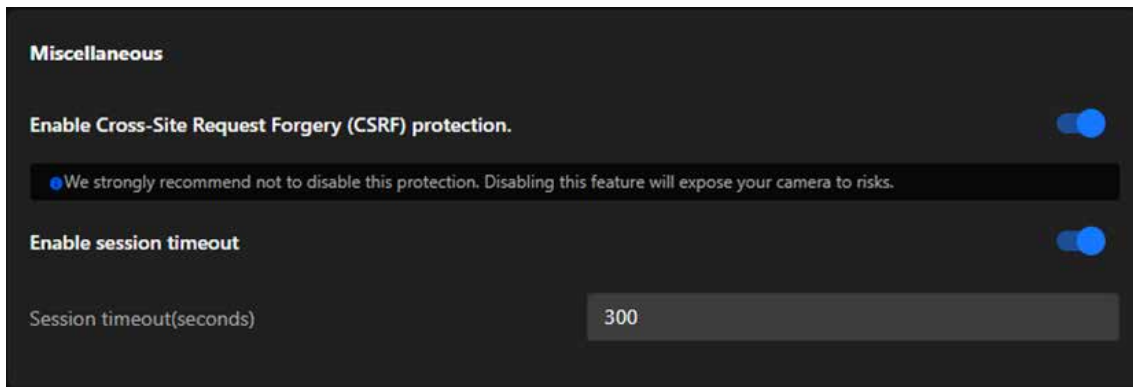

- **Enable Cross-Site Request Forgery (CSRF) Protection:**

Prevents unauthorized commands being sent from a malicious website to the camera on behalf of an authenticated user.

Note:

It is strongly recommended not to disable this feature, as disabling it could expose the camera to significant security risks.

- **Enable Session Timeout:**

Automatically logs out a user after a defined period of inactivity to prevent unauthorized access.

- **Session Timeout (seconds):**

Input field to specify the duration (in seconds) before the session times out. Default value: 300 seconds (5 minutes).

System

Manage User Access and Permissions for Enhanced Security and Control

The User Accounts is critical for managing access to the VIVOTEK camera. It allows the system administrators to create and control user accounts, define permissions, and enforce security measures such as account blocking, ensuring that the camera is secure, manageable, and accessible only by authorized users.

User

The User card provides essential tools for managing user accounts, ensuring secure access, and assigning appropriate privileges. It helps maintain a controlled environment by enabling administrators to define roles, monitor user activity, and enhance security for the camera system.

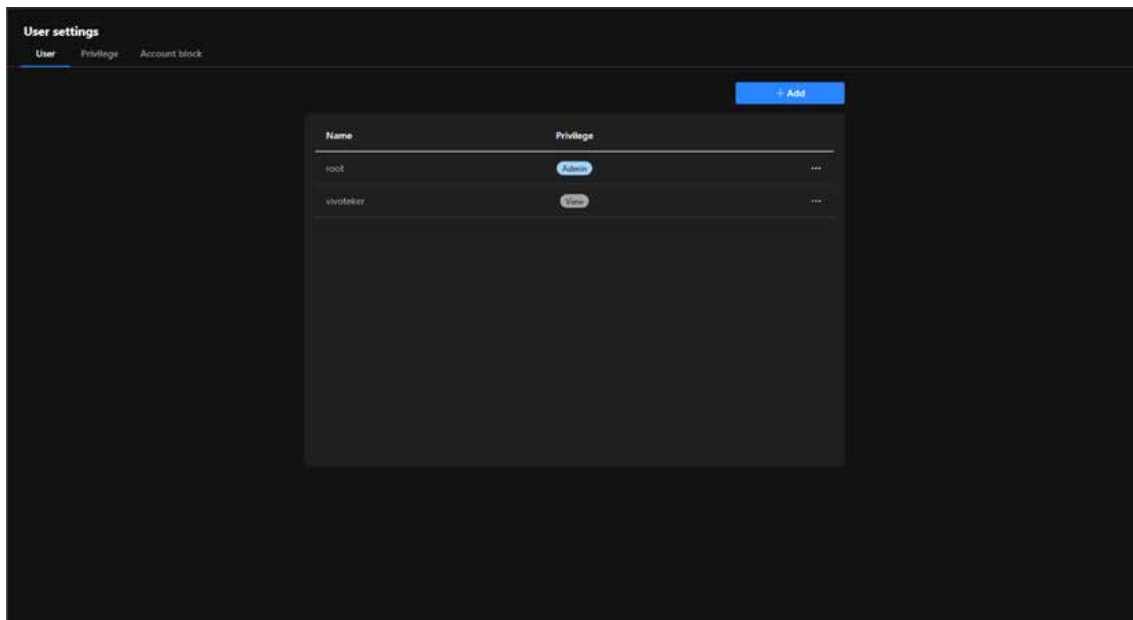

System

- Step to add an User account:

Add a user [X]

User Name
vivoteker [!]
user name should be unique

Password
..... [toggle]

Your password must have
✓ 8~64 Length of character; no space allowed
✓ At least one alphabetic character
✓ At least one numeric character

Strength **Strong**
[Progress bar]

Confirm Password
..... [toggle]

Privilege
Viewer [dropdown]

[Save] [Cancel]

Step 1. Click on the "+ Add" Button

Locate and click the + Add button to open the "Add a User" form.

Step 2. Enter the User Name

Input a unique username in the User Name field.

Note:

The username must not duplicate any existing account name.

Step 3. Set the Password

Input a password in the Password field that meets the following criteria:

- 8–64 characters in length (no spaces allowed).

- Contains at least one alphabetic character.

- Contains at least one numeric character.

Ensure the password strength bar indicates Strong for optimal security.

Step 4. Confirm the Password

Re-enter the password in the Confirm Password field to verify it matches.

System

Step 5. Assign a Privilege Level

Select the desired privilege level for the new user from the Privilege dropdown menu:

Administrator	Full control.
Operator	Control DO, white-light illuminator, snapshot, and PTZ; unable to enter the camera Configuration page.
Viewer	Control DO, white-light illuminator, view, listen, PTZ, and talk through the camera interface.

Privilege

The Privilege card in the User Accounts section allows administrators to manage the specific privileges assigned to different user roles. This ensures fine-grained control over what actions users can perform, particularly for users with restricted access levels such as Operator or Viewer.

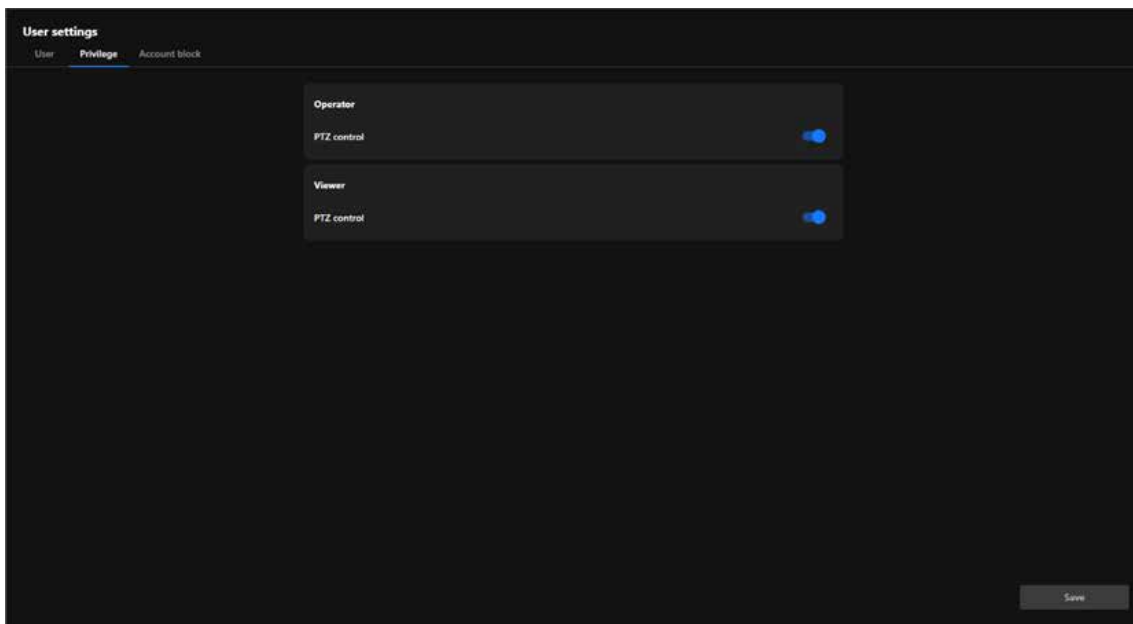

System

Account block

The Account Block is a crucial security feature that helps administrators automatically block suspicious login attempts, effectively preventing brute force attacks and enhancing system security. Through flexible condition settings and blocklist management, this feature ensures the camera system remains stable and secure in multi-user environments.

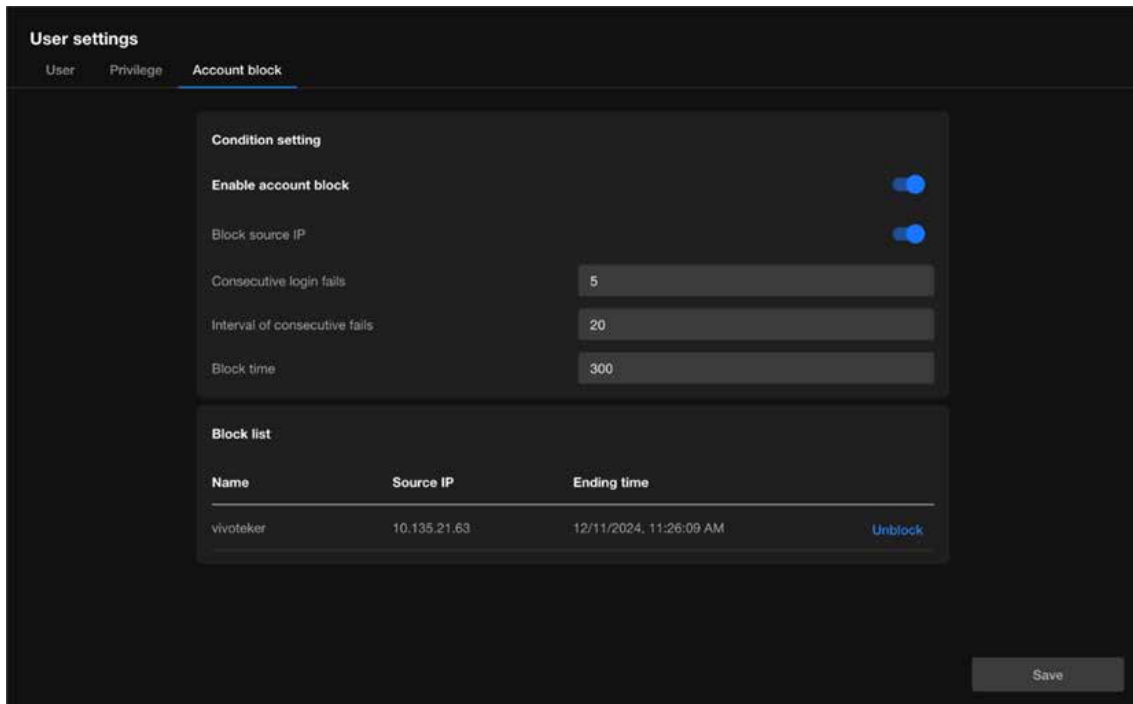

- **Condition Setting**

- **Enable Account Block**

- Activates or deactivates the account block feature. When enabled, the system automatically blocks suspicious login attempts based on the defined conditions.

- **Block Source IP**

- Blocks the IP address responsible for excessive failed login attempts, restricting further access attempts from that source.

- **Consecutive Login Fails**

- Specifies the number of consecutive failed login attempts that trigger the block. For example, if set to 5, an IP address will be blocked after 5 consecutive failed login attempts.

- **Interval of Consecutive Fails**

- Defines the time frame (in seconds) within which consecutive failed attempts are counted as a trigger for blocking.

- **Block Time**

- Sets the duration (in seconds) for which the offending IP address will remain blocked. For example, if set to 300 seconds, the IP address will be unable to attempt further logins for 5 minutes.

System

- **Block List**

Displays a list of currently blocked IP addresses or user accounts:

Name: Shows the username affected by the block.

Source IP: Indicates the IP address that triggered the block.

Ending Time: Displays the exact time when the block will expire.

Unblock:

Allows administrators to manually remove a blocked IP or account from the list.

System

Firmware Updates and Configuration Management for System Maintenance

The Maintenance offers a centralized hub for managing firmware updates, backing up and restoring configurations, and resetting the system to factory defaults. These tools ensure the VIVOTEK camera operates efficiently, stays updated, and is easy to manage for administrators overseeing surveillance systems.

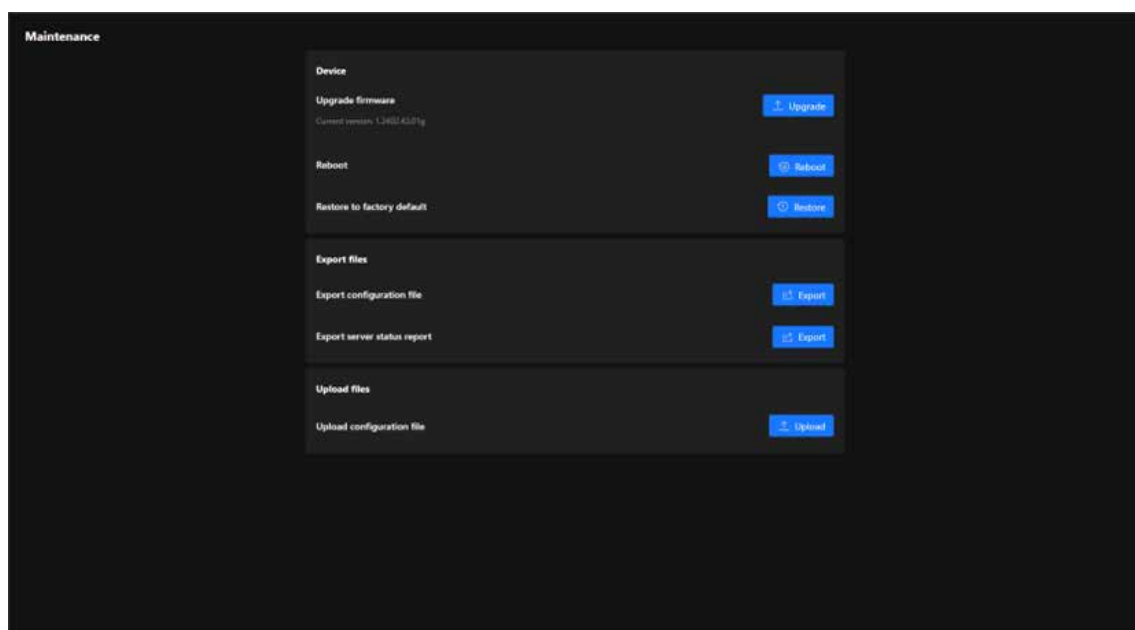

Maintenance

The Maintenance page under the System category provides tools for managing the device's firmware, configuration, and operational stability. This section enables administrators to perform essential maintenance tasks to ensure the camera functions optimally. Below is a breakdown of its functionality and purpose:

- **Device**

The Device card provides tools for firmware updates, system reboots, and factory resets. These functions ensure the camera remains updated, functional, and ready for new configurations or troubleshooting when necessary.

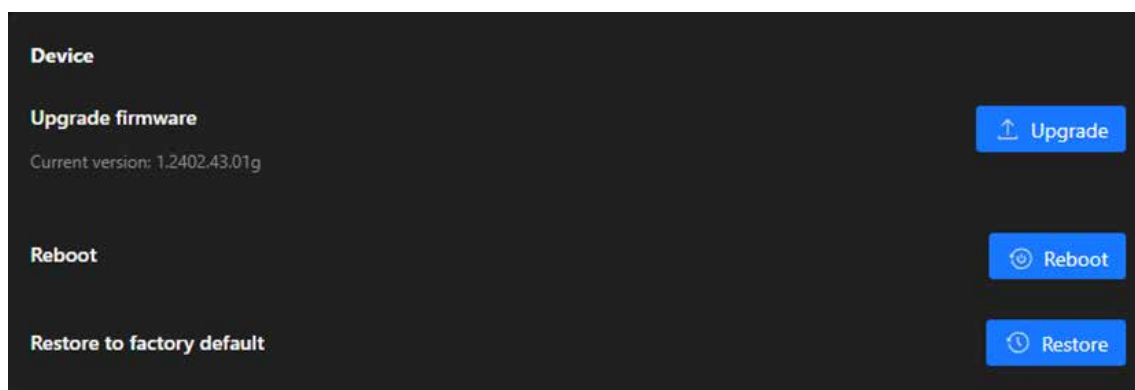

System

Upgrade Firmware

Keeps the camera up to date with the latest features, performance improvements, and security patches. Ensures compatibility with new technologies and enhanced system functionality.

Displayed Information:

Current firmware version (e.g., 1.2402.43.01g) is shown for reference.

Action:

Clicking the Upgrade button allows users to upload a new firmware file and update the device.

Reboot

Restarts the camera to refresh its system processes without altering configurations. Useful for applying changes or resolving temporary issues.

Action:

Clicking the Reboot button triggers a restart of the camera.

Restore to Factory Default

Resets the camera to its original factory settings, removing all custom configurations. This option is useful for troubleshooting persistent issues or preparing the device for redeployment.

Action:

Clicking the Restore button clears all configurations and restores default settings.

- **Export files**

The Export Files card is designed to provide administrators with tools to export important data from the camera, such as configuration settings and status reports. These features help in creating backups, diagnosing issues, or replicating settings across multiple devices.

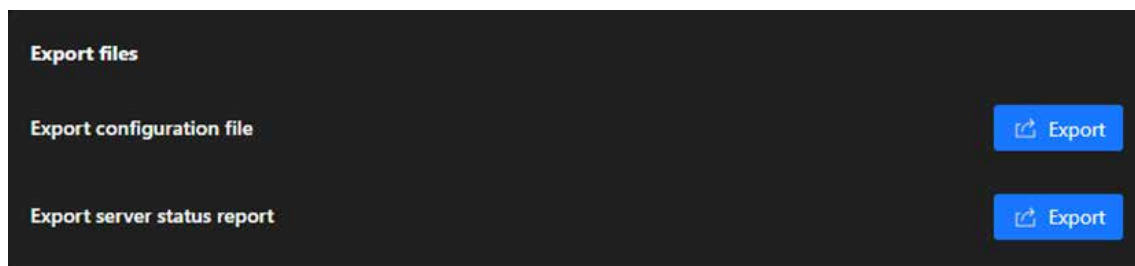

Export Configuration File

Creates a backup of the current camera configuration settings. This file can be used to:
Restore the camera settings if needed.

Replicate the same configuration on other cameras for consistency in deployment.

Action:

Clicking the Export button downloads the configuration file to the local system.

System

Export Server Status Report

Generates and exports a report containing the camera's operational status, including diagnostics and logs. This is useful for:

Analyzing performance and identifying potential issues.

Sharing status information with support teams or system administrators for troubleshooting.

Action:

Clicking the Export button downloads the server status report for further analysis.

- **Upload files**

The Upload Files card allows administrators to restore or apply preconfigured settings to the camera by uploading a configuration file. This feature is particularly useful for system recovery or deploying standardized configurations across multiple devices.

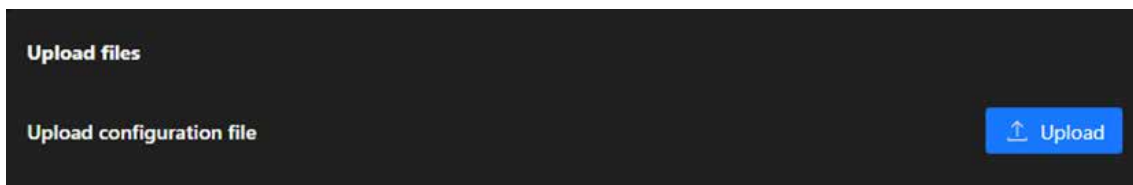

Upload Configuration File

This function enables the restoration of the camera's settings using a previously exported configuration file, simplifying the replication of configurations across multiple cameras and speeding up recovery in cases of system resets or data loss.

Action:

Clicking the Upload button allows users to select a configuration file from their local system and apply it to the camera.

System

Optimized Storage Solutions for Reliable Video Recording and Data Retention

The Storage section offers a comprehensive suite of tools to manage and optimize the camera's storage resources. Whether utilizing internal memory, SD cards, or external NAS devices, this section ensures reliable video recording and efficient data retention. With features like cyclic storage, reserved space settings, and automatic cleanup, administrators can ensure continuous operation and maximize storage capacity effortlessly.

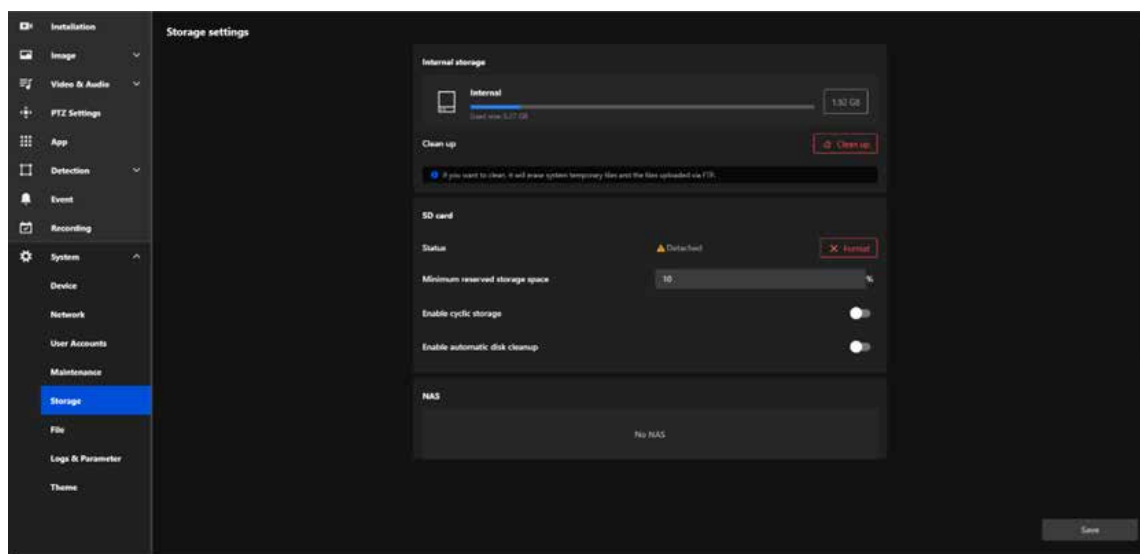

- **Storage settings**

The Storage settings is designed to manage storage devices and optimize the storage space used for video recording, file saving, and system operations. This section provides administrators with tools to monitor, clean, and configure storage options, ensuring the camera operates efficiently and retains critical data.

- **Internal storage**

The Internal storage card is designed to manage and monitor the camera's internal memory usage. It provides an overview of the storage capacity, current usage, and tools for maintaining storage efficiency by removing unnecessary files.

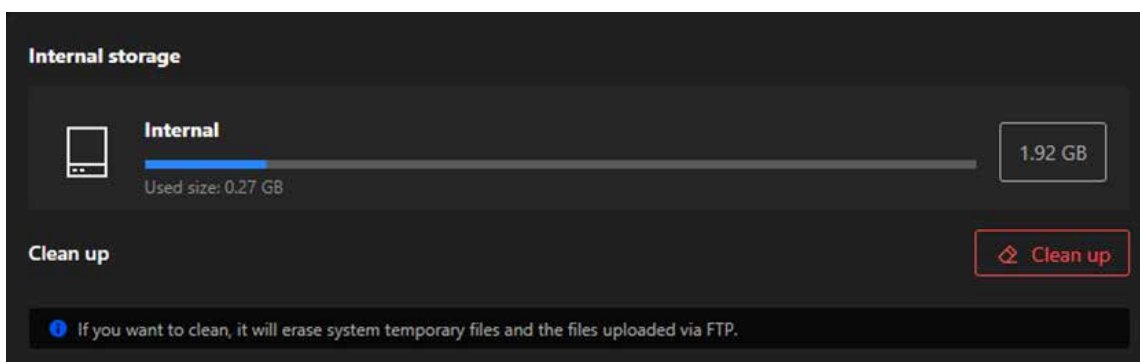

System

Storage Overview

Displayed Information:

Total Capacity: Displays the total storage capacity of the internal memory (e.g., 1.92 GB).

Used Size: Indicates the amount of storage currently being used (e.g., 0.27 GB).

Usage Bar: Visually represents the proportion of used and available storage.

Clean Up

Frees up internal storage by deleting unnecessary files, such as:

System temporary files.

Files uploaded via FTP.

Action:

Clicking the Clean Up button initiates the cleanup process, clearing the designated files and making more space available for important data.

SD card

The SD card allows administrators to manage and monitor the SD card's usage, status, and settings. This functionality is crucial for ensuring reliable data storage and maintaining continuous video recording or file saving.

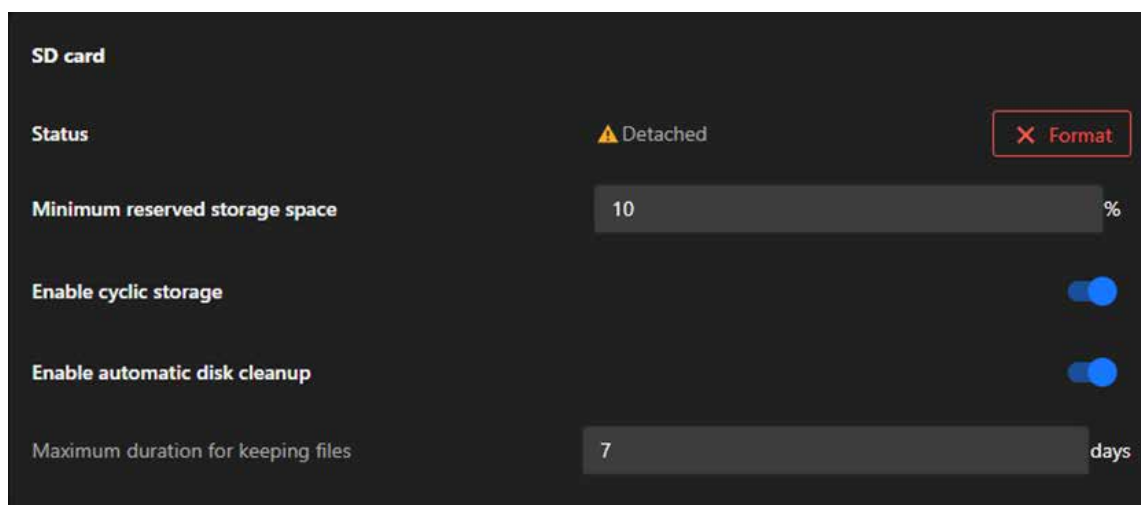

Status

Displays the current status of the SD card (e.g., "Detached" if no card is inserted or recognized).

Actions:

Use the Format button to erase all files and initialize the SD card for use.

Minimum Reserved Storage Space

Reserves a percentage of the SD card's total capacity to prevent it from being entirely filled, ensuring critical operations can continue.

Actions:

Enter a percentage (e.g., 10%) to reserve storage space.

System

Enable Cyclic Storage

Enables automatic overwriting of the oldest data on the SD card when it is full, ensuring continuous recording.

Action:

Toggle this feature on or off to control storage behavior.

Enable Automatic Disk Cleanup

Automates the deletion of unnecessary or older files to free up storage space.

Dependency:

Enabling this feature activates the Maximum Duration for Keeping Files option.

Actions:

Toggle this feature on to allow automatic cleanup of outdated files.

Maximum Duration for Keeping Files

Sets a specific retention period for files on the SD card (e.g., 7 days). Files older than the specified duration are deleted automatically.

Actions:

Input the desired number of days for file retention in the text box.

To Prepare the SD Card:

Step 1. Insert an SD card into the camera's slot.

Step 2. Check the Status field to confirm the SD card is detected.

Step 3. If the SD card is new or needs reinitialization:

Click the Format button to erase its contents and prepare it for use.

To Configure Storage Settings:

Step 1. Set the Minimum Reserved Storage Space:

Input a percentage (e.g., 10%) to reserve part of the SD card's capacity.

Step 2. Toggle Enable Cyclic Storage:

Turn this feature on to allow the oldest files to be overwritten when the SD card is full.

Step 3. Enable Automatic Disk Cleanup (Optional):

Toggle this option to activate cleanup functions.

Input the Maximum Duration for Keeping Files (e.g., 7 days) to define the file retention period.

To Ensure Continuous Recording:

Step 1. Confirm both Enable Cyclic Storage and Enable Automatic Disk Cleanup are activated.

Step 2. Regularly check the Status to ensure the SD card is functioning properly.

System

- **NAS**

The NAS card allows administrators to integrate a Network Attached Storage (NAS) device for extended and scalable storage. This feature ensures that the camera’s storage capacity can be expanded and data can be securely stored in a centralized location.

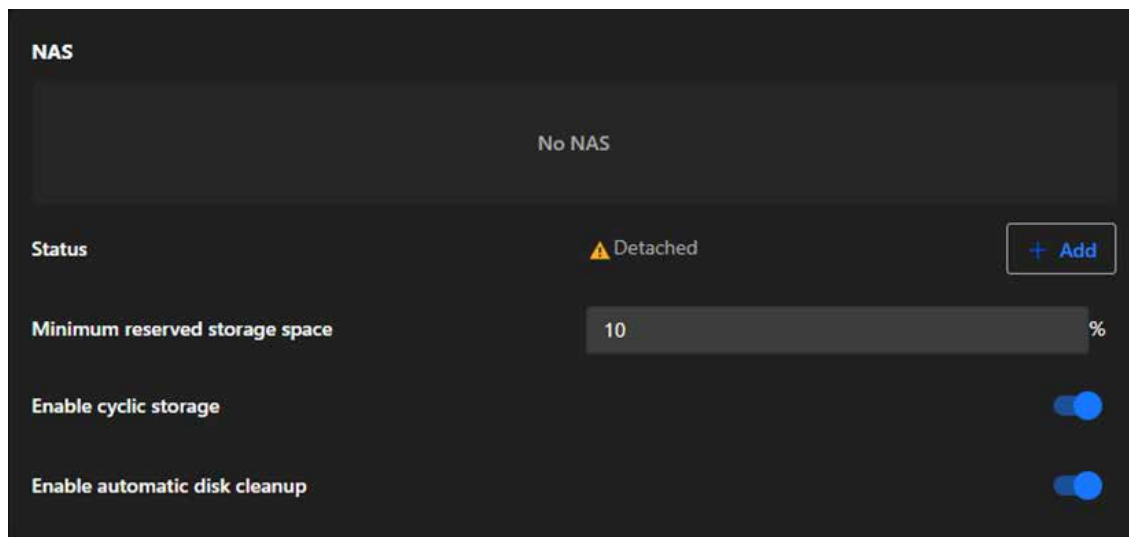

NAS Status

Displays the connection status of the NAS device (e.g., “Detached” if no connection is established).

Actions:

Click + Add to configure and connect a NAS device.

Minimum Reserved Storage Space

Ensures that a defined percentage of the NAS storage remains reserved to prevent the system from filling the NAS entirely.

Actions:

Administrators can input a percentage (e.g., 10%) to reserve storage space for critical use.

Enable Cyclic Storage

Allows the camera to overwrite the oldest files stored on the NAS when the storage is full, ensuring uninterrupted recording.

Actions:

Toggle this feature on or off depending on the storage management preferences.

Enable Automatic Disk Cleanup

Automates the cleanup of outdated or unnecessary files stored on the NAS to maintain sufficient available space.

Actions:

Toggle this feature on to activate automatic file deletion based on system-defined criteria.

System

NAS Configuration Steps

Step 1. Open NAS Storage Settings:

Click + Add in the NAS card to open the configuration window.

Step 2. Set Network Storage Location:

Enter the path to the NAS storage folder (e.g., \\NASDevice\SharedFolder).

Step 3. Enter Workgroup (Optional):

If required, specify the workgroup to which the NAS device belongs.

Step 4. Provide User Credentials:

Input the Username and Password needed to authenticate and access the NAS device.

Step 5. Test the Connection:

Click Test to ensure the camera can successfully connect to the specified NAS location.

Step 6. Save Configuration:

Click Save to apply the settings and establish the connection.

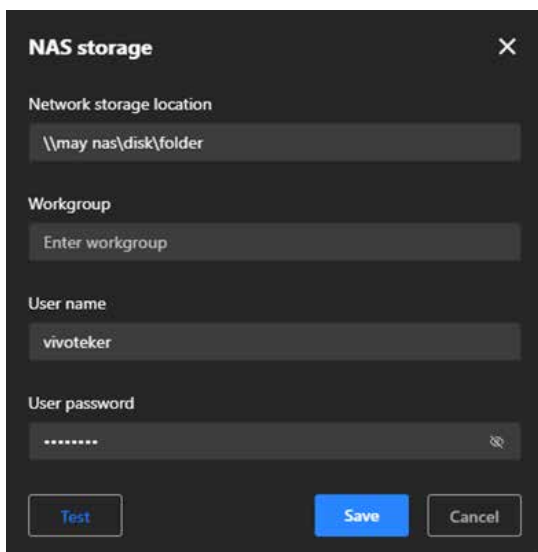

The screenshot shows a dark-themed configuration window titled "NAS storage" with a close button (X) in the top right corner. It contains four input fields: "Network storage location" with the value "\\my nas\disk\folder", "Workgroup" with the placeholder "Enter workgroup", "User name" with the value "vivoteker", and "User password" with masked characters "*****" and a visibility toggle icon. At the bottom, there are three buttons: "Test", "Save", and "Cancel".

System

Effortless Management and Retrieval of Recorded Media

The File section offers a user-friendly interface for managing recorded media files. With search and filtering tools, users can locate specific recordings based on storage type, trigger events, media format, and time frame. It also allows locking files, exporting recordings, and converting media for efficient handling and preservation. This ensures organized storage and quick access to important data.

File

The File section enables users to efficiently search, filter, and manage recorded media files. Key features include advanced search criteria, file locking for data retention, and options to export or convert recordings. Its primary purpose is to streamline media organization, ensure secure storage, and support quick access for detailed analysis.

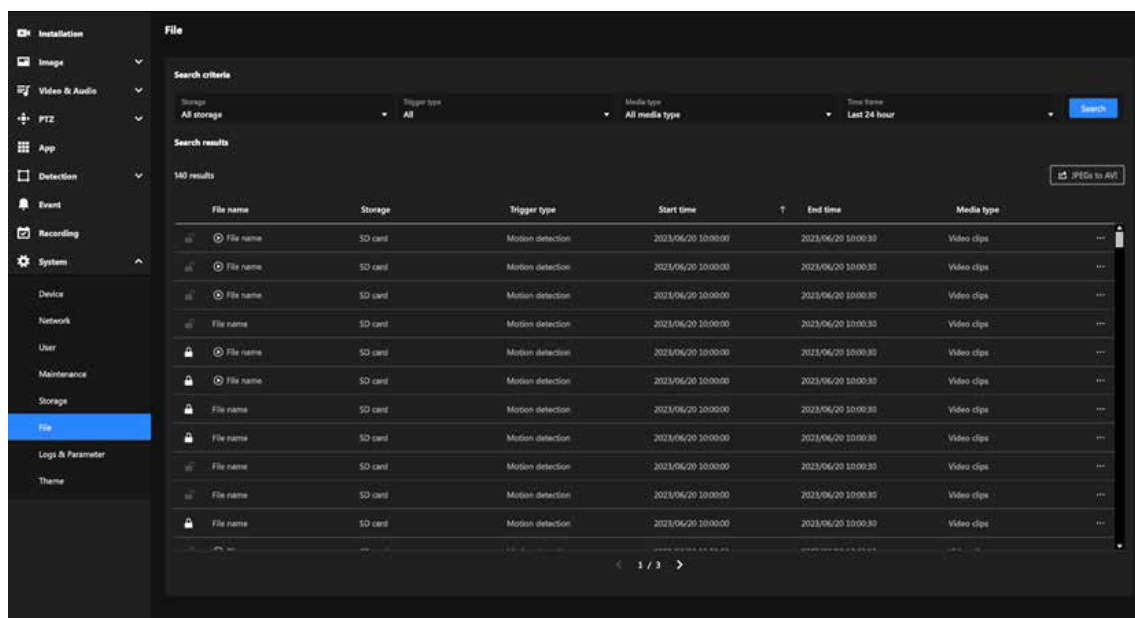

• Search criteria

Allows users to refine their search for recorded files based on specific parameters, making it easier to locate relevant recordings.

Search Filters:

- **Storage:** Filter by storage type (e.g., SD card, NAS, or all storage devices).
- **Trigger Type:** Search for files triggered by specific events (e.g., motion detection, manual recording).
- **Media Type:** Filter by the type of media (e.g., video clips, snapshots).
- **Time Frame:** Specify a time range (e.g., last 24 hours, custom time range) to narrow the search.

System

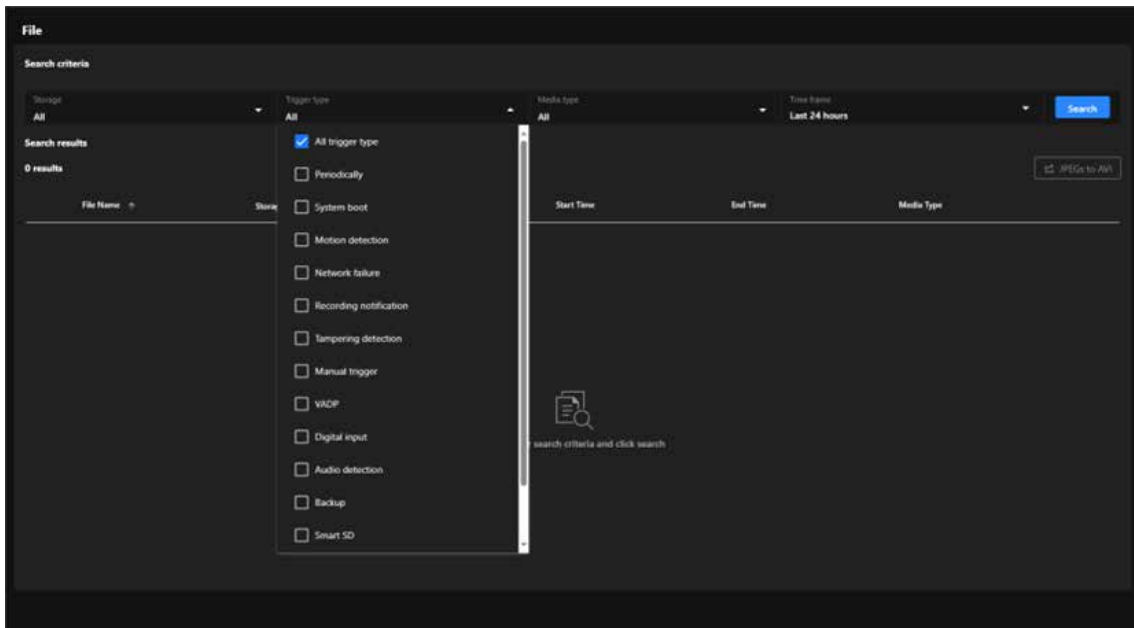

● Search Results

File Name:

Name of the recorded file.

Storage:

Indicates the storage location of the file (e.g., SD card).

Trigger Type:

Shows the event that triggered the recording (e.g., motion detection).

Start and End Time:

Provides the time range for each recording.

Media Type:

Specifies the type of media file (e.g., video clips).

The screenshot shows a table of search results. The table has 7 columns: 'File name', 'Storage', 'Trigger type', 'Start time', 'End time', and 'Media type'. There are 140 results in total, with a '1 / 3' indicator at the bottom. The first few rows show results for 'Motion detection' on 'SD card' with 'Video clips' as the media type. The start and end times for all results are '2023/06/20 10:00:00' and '2023/06/20 10:00:30' respectively. A 'JPEGS to AVI' button is visible in the top right corner of the results area.

File name	Storage	Trigger type	Start time	End time	Media type
File name	SD card	Motion detection	2023/06/20 10:00:00	2023/06/20 10:00:30	Video clips
File name	SD card	Motion detection	2023/06/20 10:00:00	2023/06/20 10:00:30	Video clips
File name	SD card	Motion detection	2023/06/20 10:00:00	2023/06/20 10:00:30	Video clips
File name	SD card	Motion detection	2023/06/20 10:00:00	2023/06/20 10:00:30	Video clips
File name	SD card	Motion detection	2023/06/20 10:00:00	2023/06/20 10:00:30	Video clips
File name	SD card	Motion detection	2023/06/20 10:00:00	2023/06/20 10:00:30	Video clips
File name	SD card	Motion detection	2023/06/20 10:00:00	2023/06/20 10:00:30	Video clips
File name	SD card	Motion detection	2023/06/20 10:00:00	2023/06/20 10:00:30	Video clips
File name	SD card	Motion detection	2023/06/20 10:00:00	2023/06/20 10:00:30	Video clips
File name	SD card	Motion detection	2023/06/20 10:00:00	2023/06/20 10:00:30	Video clips

System

- **Note:**

File Lock/Unlock button:

Locked files, identified by a lock icon, are protected from automatic deletion, and their retention can be managed using the lock/unlock button.

Play button:

Only files with recorded data and playback permission will display the Play button.

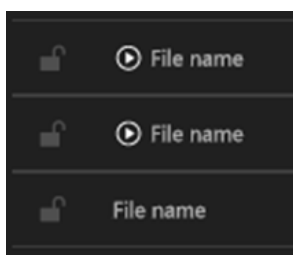

File Options (More icon)

Each file in the results has additional options accessible via the three-dot menu:

- **Download:**

Allows you to save the file to your local device. Steps:

Step 1. Click the three-dot menu next to a file.

Step 2. Select Download.

Step 3. The file will be saved to your default download location.

- **Delete:**

Permanently removes the file from the storage. Steps:

Step 1. Click the three-dot menu next to a file.

Step 2. Select Delete.

Step 3. Confirm the deletion in the pop-up prompt.



- **JPEGs to AVI**

The JPEGs to AVI functionality allows users to convert sequential JPEG image snapshots into a playable AVI video format. This feature is particularly useful for scenarios where users need to review footage as a continuous video instead of analyzing individual images.

Steps to Use JPEGs to AVI:

Step 1. Click “JPEGs to AVI” button.

Step 2. Selection Feature Activation:

A checkbox is displayed next to each snapshot file, allowing users to manually select which files to include in the AVI conversion.

System

Step 3. Two new buttons appear:

Combine

This button allows the user to confirm and initiate the conversion process. It is enabled only after at least one file is selected.

Cancel

Clicking this button exits the conversion mode, clearing all selections and restoring the original file view.

Step 4. Start combining into a single AVI file.

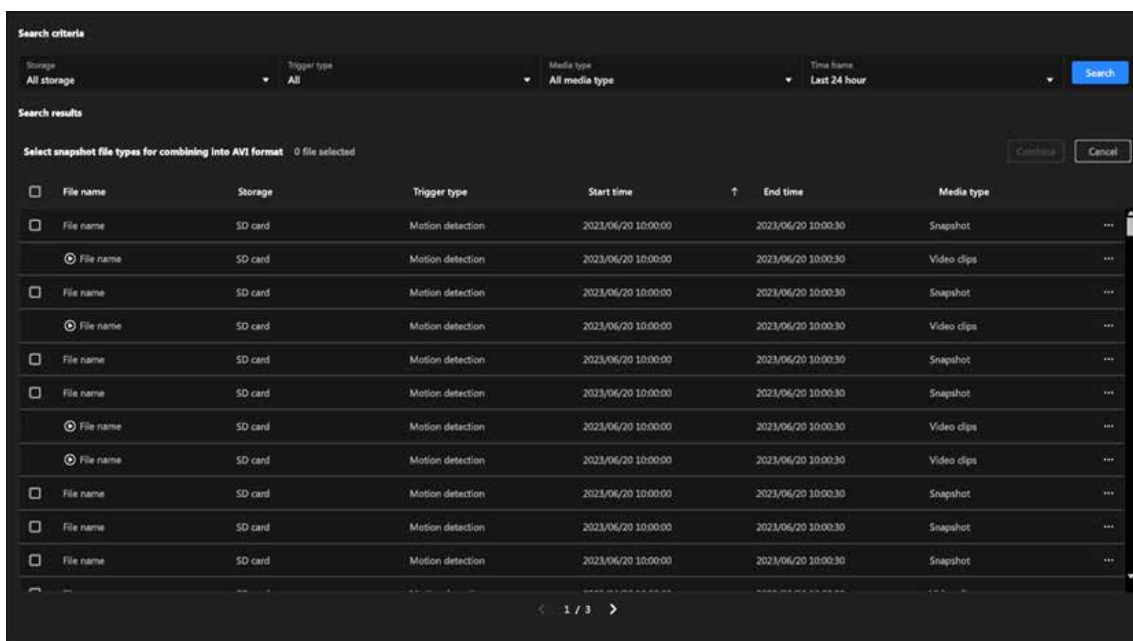

System

Steps to set up the Remote log server:

Step 1. Click "+Add" button.

Step 2. In the IP address text box, enter the IP address of the remote server.

Step 3. In the port text box, enter the port number of the remote server.

Step 4. When completed, click Save to enable the setting.

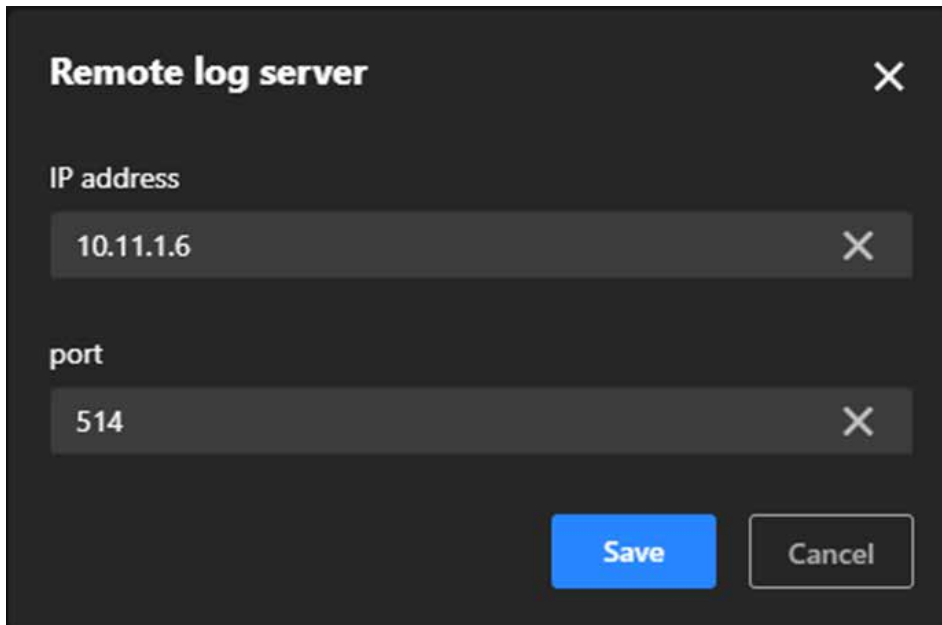

The image shows a dark-themed dialog box titled "Remote log server" with a close button (X) in the top right corner. It contains two input fields: "IP address" with the value "10.11.1.6" and "port" with the value "514". Each input field has a small "X" icon on its right side. At the bottom of the dialog, there are two buttons: a blue "Save" button and a white "Cancel" button with a grey border.

- **Logs**

The Logs provides users with detailed records of system activities, access attempts, configuration changes, and application performance. It simplifies troubleshooting by helping users identify issues, enhances security by monitoring access, and ensures transparency in configuration management. This feature is especially useful for maintaining system stability, tracking unauthorized access, and diagnosing application or configuration-related problems. The Logs consists of the following categories, each designed to record specific types of information:

System:

Records key system activities, including device startup, reboot, error messages, and mode switching, to help determine system stability and identify potential issues.

System

```
Logs
System Access Set parameter VADP
Jan 11 16:52:25 syslogd 1.5.0: restart.
Jan 11 16:52:27 [VENC]: Day mode
Jan 11 16:52:27 [VENC]: Fixed-Iris!
Jan 11 16:52:28 [swatchdog]: Ready to watch venc.
Jan 11 16:52:28 [VENC]: Entering motion process loop!
Jan 11 16:52:28 [VENC]: Set Optimized IR Attr fail
Jan 11 16:52:28 [VENC]: ptMotionInfo->tMotionTmpCfg.dwRotateAngle = 0
Jan 11 16:52:28 [AENC_ADEC]: aenc received SIG_RELOAD_AENC_CONF/SIGHUP
Jan 11 16:52:29 [VENC]: ptMotionInfo->tMotionTmpCfg.dwRotateAngle = 0
Jan 11 16:52:29 [RTSP SERVER]: XMLSParser: open /etc/conf.d/config_onvif/config_onvif_media_p
Jan 11 16:52:29 [RTSP SERVER]: XMLSParser: open /etc/conf.d/config_onvif/config_onvif_media_v
Jan 11 16:52:29 [RTSP SERVER]: XMLSParser: open /etc/conf.d/config_onvif/config_onvif_media_a
Jan 11 16:52:29 [RTSP SERVER]: XMLSParser: open /etc/conf.d/config_onvif/config_onvif_metadat
Jan 11 16:52:29 last message repeated 7 times
Jan 11 16:52:29 [VENC]: =====Register Output[0] CmdID=rtsp path=/var/run/venc/c0/s0/mediasck_
Jan 11 16:52:29 [VENC]: =====rtsp [LINE:94]
Jan 11 16:52:29 [swatchdog]: Ready to watch rtsp.
Jan 11 16:52:29 [VENC]: =====Register Output[0] CmdID=rtsp path=/var/run/venc/c0/s1/mediasck_
Jan 11 16:52:29 [VENC]: =====rtsp [LINE:94]
Jan 11 16:52:29 [VENC]: =====Register Output[0] CmdID=rtsp path=/var/run/venc/c0/s2/mediasck_
Jan 11 16:52:29 [VENC]: =====rtsp [LINE:94]
Jan 11 16:52:29 [CertMgr]: [Notice] Create default TLS certificate ok!
Jan 11 16:52:30 avahi-autoipd(eth0)[2166]: client: .
Jan 11 16:52:31 [VENC]: ptMotionInfo->tMotionTmpCfg.dwRotateAngle = 0
Jan 11 16:52:31 avahi-autoipd(eth0)[2166]: Sprint execution failed with return value 1
```

Access:

Logs all access attempts to the camera, including login and logout operations, making it useful for monitoring unauthorized access attempts and ensuring system security.

```
Logs
System Access Set parameter VADP
Aug 15 13:45:24 [RTSP SERVER]: Start one session, IP=192.168.200.1
Aug 15 13:45:56 last message repeated 3 times
Aug 15 13:55:41 [RTSP SERVER]: Stop one session, IP=192.168.200.1
Aug 20 23:35:02 [RTSP SERVER]: Start one session, IP=172.19.1.177
Aug 20 23:37:25 [RTSP SERVER]: Stop one session, IP=172.19.1.177
Jan 20 11:52:41 [RTSP SERVER]: Start one session, IP=172.19.11.180
Jan 20 11:52:43 [RTSP SERVER]: Stop one session, IP=172.19.11.180
Jan 20 12:00:50 [RTSP SERVER]: Start one session, IP=172.19.11.180
Jan 20 12:00:56 [RTSP SERVER]: Stop one session, IP=172.19.11.180
Jan 20 12:04:44 [RTSP SERVER]: Start one session, IP=172.19.11.180
Jan 20 12:58:13 [RTSP SERVER]: Start one session, IP=172.19.11.180
Jan 20 12:58:14 [RTSP SERVER]: Stop one session, IP=172.19.11.180
Jan 20 13:30:01 [RTSP SERVER]: Start one session, IP=172.19.11.180
Jan 20 13:30:25 [RTSP SERVER]: Stop one session, IP=172.19.11.180
Feb 4 12:00:46 [RTSP SERVER]: Start one session, IP=172.19.11.180
Feb 4 12:00:49 [RTSP SERVER]: Stop one session, IP=172.19.11.180
Dec 3 14:34:04 [RTSP SERVER]: Start one session, IP=172.19.11.180
Dec 3 14:35:14 [RTSP SERVER]: Stop one session, IP=172.19.11.180
Dec 3 14:35:16 [RTSP SERVER]: Start one session, IP=172.19.11.180
Dec 3 14:35:30 [RTSP SERVER]: Stop one session, IP=172.19.11.180
Dec 3 14:35:33 [RTSP SERVER]: Start one session, IP=172.19.11.180
Dec 3 14:35:33 [RTSP SERVER]: Stop one session, IP=172.19.11.180
Dec 3 14:35:35 [RTSP SERVER]: Start one session, IP=172.19.11.180
Dec 3 14:36:01 [RTSP SERVER]: Stop one session, IP=172.19.11.180
```

System

Set Parameter:

Tracks all configuration changes made to the system, assisting users in reviewing and managing adjustments while facilitating troubleshooting of configuration-related issues.

```
Logs
System Access Set parameter VADP
Jan 11 16:52:27 [CONFIGER]: Set videoin_c0_s0_overlay0_text_actualseize=30
Jan 11 16:52:27 [CONFIGER]: Set videoin_c0_s0_overlay1_text_actualseize=30
Jan 11 16:52:27 [CONFIGER]: Set videoin_c0_s0_overlay2_text_actualseize=30
Jan 11 16:52:27 [CONFIGER]: Set videoin_c0_s0_overlay3_text_actualseize=30
Jan 11 16:52:27 [CONFIGER]: Set videoin_c0_s1_overlay0_text_actualseize=24
Jan 11 16:52:27 [CONFIGER]: Set videoin_c0_s1_overlay1_text_actualseize=24
Jan 11 16:52:27 [CONFIGER]: Set videoin_c0_s1_overlay2_text_actualseize=24
Jan 11 16:52:27 [CONFIGER]: Set videoin_c0_s1_overlay3_text_actualseize=24
Jan 11 16:52:28 [CONFIGER]: Set videoin_c0_s2_overlay0_text_actualseize=20
Jan 11 16:52:28 [CONFIGER]: Set videoin_c0_s2_overlay1_text_actualseize=20
Jan 11 16:52:28 [CONFIGER]: Set videoin_c0_s2_overlay2_text_actualseize=20
Jan 11 16:52:28 [CONFIGER]: Set videoin_c0_s2_overlay3_text_actualseize=20
Jan 11 16:52:28 [CONFIGER]: Set videoin_c0_s0_overlay0_text_actualseize=30
Jan 11 16:52:28 [CONFIGER]: Set videoin_c0_s0_overlay1_text_actualseize=30
Jan 11 16:52:28 [CONFIGER]: Set videoin_c0_s0_overlay2_text_actualseize=30
Jan 11 16:52:28 [CONFIGER]: Set videoin_c0_s0_overlay3_text_actualseize=30
Jan 11 16:52:29 [CONFIGER]: Set videoin_c0_s1_overlay0_text_actualseize=24
Jan 11 16:52:29 [CONFIGER]: Set videoin_c0_s1_overlay1_text_actualseize=24
Jan 11 16:52:29 [CONFIGER]: Set videoin_c0_s1_overlay2_text_actualseize=24
Jan 11 16:52:29 [CONFIGER]: Set videoin_c0_s1_overlay3_text_actualseize=24
Jan 11 16:52:30 [CONFIGER]: Set status_c0_daynight=day
Jan 11 16:52:30 [CONFIGER]: Set videoin_c0_s2_overlay0_text_actualseize=20
Jan 11 16:52:30 [CONFIGER]: Set videoin_c0_s2_overlay1_text_actualseize=20
Jan 11 16:52:30 [CONFIGER]: Set videoin_c0_s2_overlay2_text_actualseize=20
Jan 11 16:52:30 [CONFIGER]: Set videoin_c0_s2_overlay3_text_actualseize=20
```

System

VADP:

Logs related to the VIVOTEK Application Development Platform, documenting the execution of applications on the camera (if applicable) and helping to diagnose application development and runtime issues.

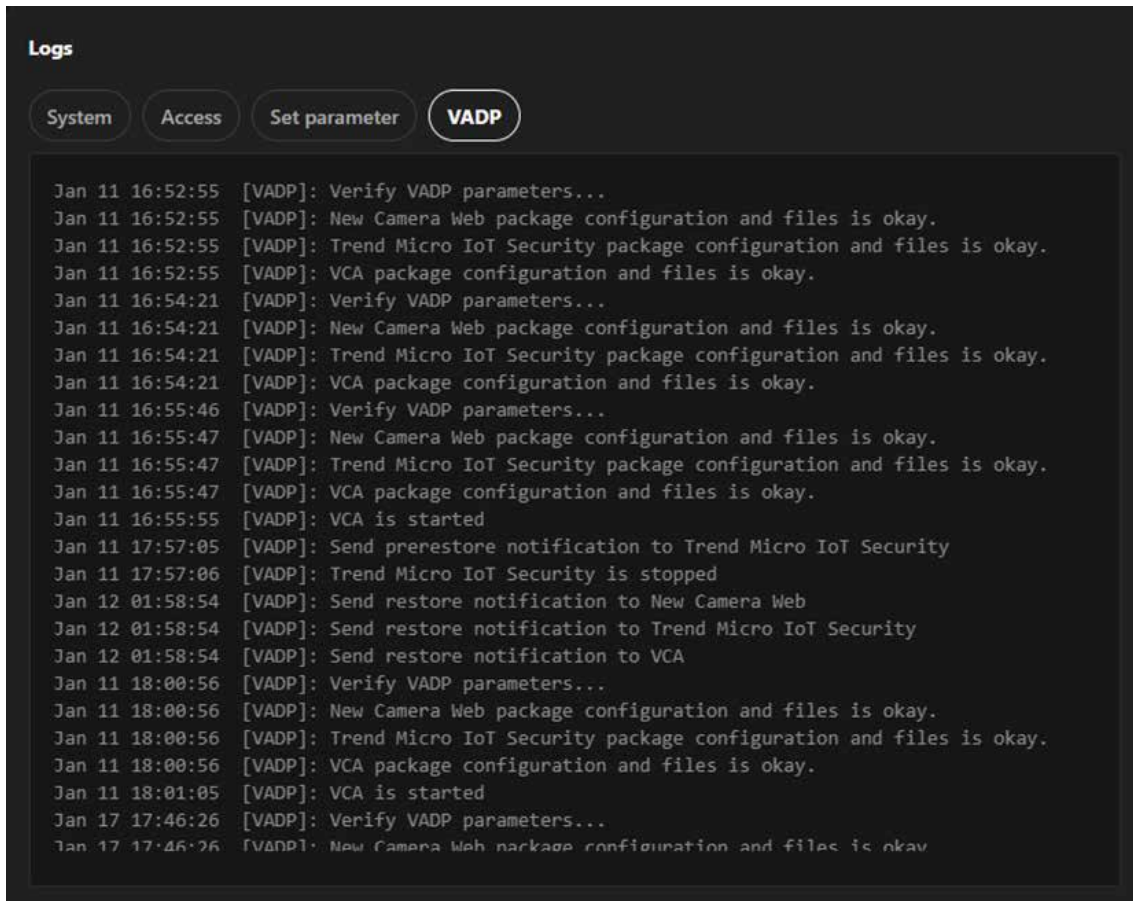

The screenshot shows a 'Logs' window with four filter buttons: 'System', 'Access', 'Set parameter', and 'VADP'. The 'VADP' button is selected. Below the buttons is a list of log entries with timestamps and messages.

```
Jan 11 16:52:55 [VADP]: Verify VADP parameters...
Jan 11 16:52:55 [VADP]: New Camera Web package configuration and files is okay.
Jan 11 16:52:55 [VADP]: Trend Micro IoT Security package configuration and files is okay.
Jan 11 16:52:55 [VADP]: VCA package configuration and files is okay.
Jan 11 16:54:21 [VADP]: Verify VADP parameters...
Jan 11 16:54:21 [VADP]: New Camera Web package configuration and files is okay.
Jan 11 16:54:21 [VADP]: Trend Micro IoT Security package configuration and files is okay.
Jan 11 16:54:21 [VADP]: VCA package configuration and files is okay.
Jan 11 16:55:46 [VADP]: Verify VADP parameters...
Jan 11 16:55:47 [VADP]: New Camera Web package configuration and files is okay.
Jan 11 16:55:47 [VADP]: Trend Micro IoT Security package configuration and files is okay.
Jan 11 16:55:47 [VADP]: VCA package configuration and files is okay.
Jan 11 16:55:55 [VADP]: VCA is started
Jan 11 17:57:05 [VADP]: Send prerestore notification to Trend Micro IoT Security
Jan 11 17:57:06 [VADP]: Trend Micro IoT Security is stopped
Jan 12 01:58:54 [VADP]: Send restore notification to New Camera Web
Jan 12 01:58:54 [VADP]: Send restore notification to Trend Micro IoT Security
Jan 12 01:58:54 [VADP]: Send restore notification to VCA
Jan 11 18:00:56 [VADP]: Verify VADP parameters...
Jan 11 18:00:56 [VADP]: New Camera Web package configuration and files is okay.
Jan 11 18:00:56 [VADP]: Trend Micro IoT Security package configuration and files is okay.
Jan 11 18:00:56 [VADP]: VCA package configuration and files is okay.
Jan 11 18:01:05 [VADP]: VCA is started
Jan 17 17:46:26 [VADP]: Verify VADP parameters...
Jan 17 17:46:26 [VADP]: New Camera Web package configuration and files is okay
```

System

Audit log

The Audit log focuses on recording all administrative operations and activities performed on the camera. Its purpose is to track user behavior, enhance system security, ensure management transparency, and meet compliance requirements. By logging detailed user actions, it helps administrators analyze issues, troubleshoot errors, and provide reliable historical data for audits.

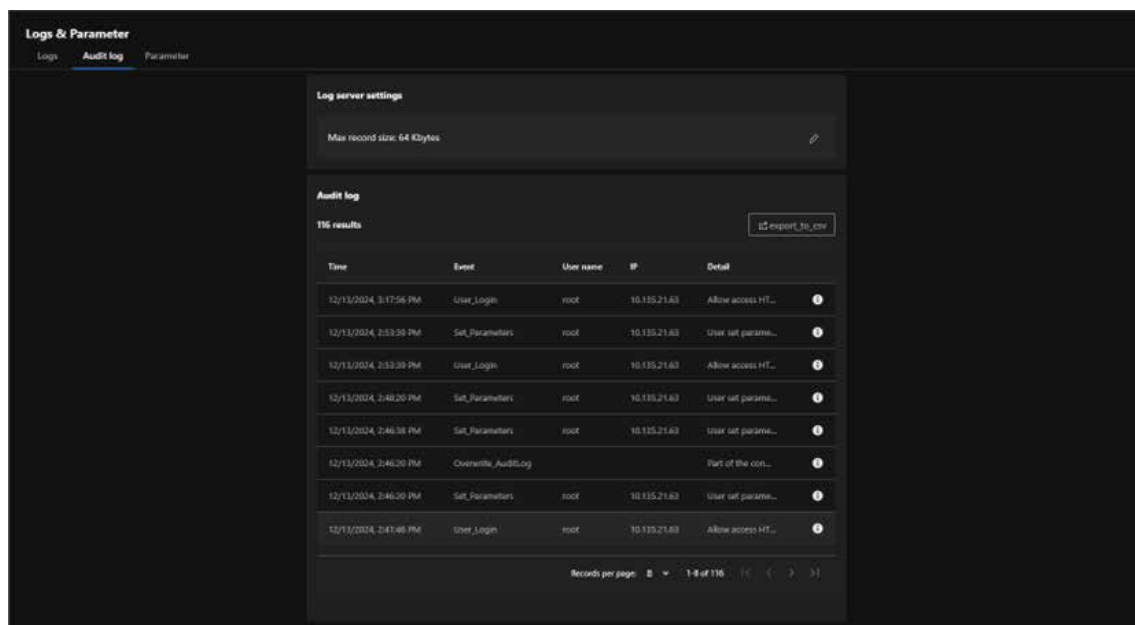

- **Log server settings**

Allows users to adjust log storage capacity to ensure sufficient space for recording management activities.

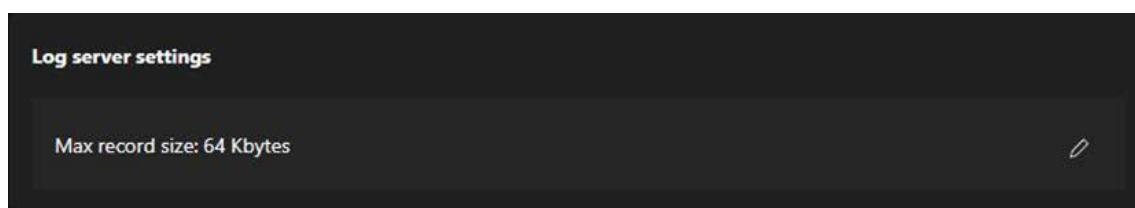

- **Audit log**

Provides detailed records of each administrative action, including the following fields:

Time:

The specific time the action occurred.

Event:

The type of action performed (e.g., "User_Login" for logins, "Set_Parameters" for parameter adjustments).

User Name:

The username of the person performing the action (e.g., "root").

IP:

The IP address of the device initiating the action.

Detail:

Detailed descriptions of the actions, such as "Allow access HTTP" or "User set parameters."

System

Audit log

116 results export_to_csv

Time	Event	User name	IP	Detail	
12/13/2024, 3:17:56 PM	User_Login	root	10.135.21.63	Allow access HT...	
12/13/2024, 2:53:39 PM	Set_Parameters	root	10.135.21.63	User set parame...	
12/13/2024, 2:53:39 PM	User_Login	root	10.135.21.63	Allow access HT...	
12/13/2024, 2:48:20 PM	Set_Parameters	root	10.135.21.63	User set parame...	
12/13/2024, 2:46:38 PM	Set_Parameters	root	10.135.21.63	User set parame...	
12/13/2024, 2:46:20 PM	Overwrite_AuditLog			Part of the con...	
12/13/2024, 2:46:20 PM	Set_Parameters	root	10.135.21.63	User set parame...	
12/13/2024, 2:41:46 PM	User_Login	root	10.135.21.63	Allow access HT...	

Records per page: 8 1-8 of 116

Export Functionality:

The **Export to CSV** button allows users to export audit logs as CSV files for archiving, sharing, or further analysis.

System

Parameter

The Parameter is designed to display the system parameters and configuration details of the camera, providing administrators with a centralized view of the device's operational status, settings, and technical information. Its main purpose is to serve as a diagnostic tool, facilitate technical support, and assist in configuration backup and recovery.

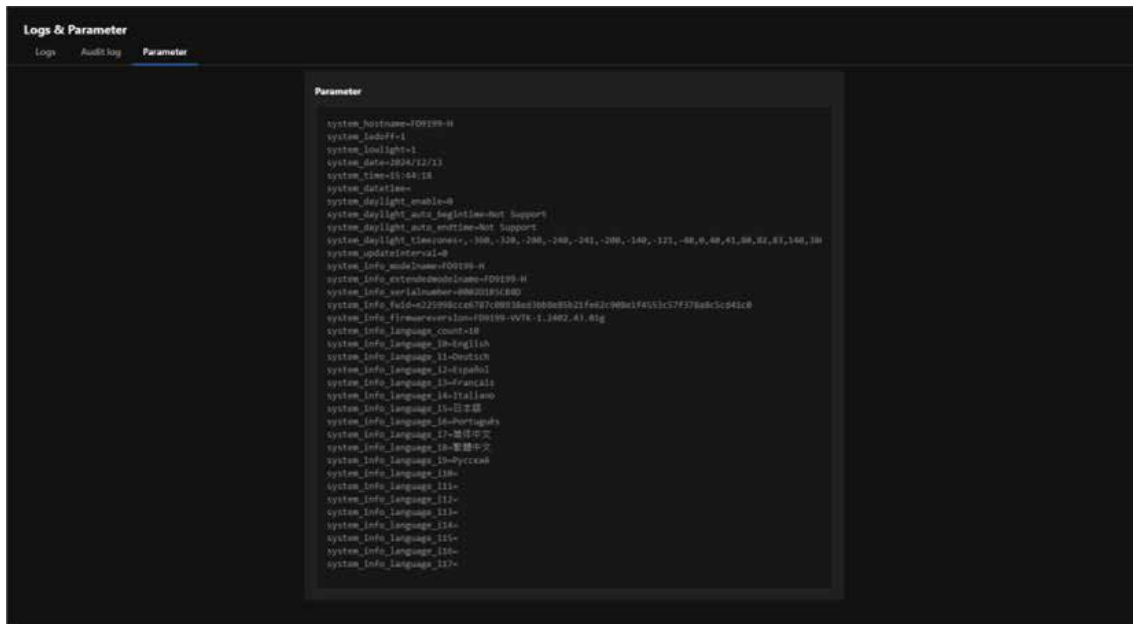

System

Customizing Interface Appearance and Branding with Theme Settings

The Theme settings section allows users to personalize the camera's interface to suit their preferences and enhance the user experience. By providing options to toggle between light and dark modes, users can adapt the interface for different lighting conditions. Additionally, the ability to upload a custom logo and configure a hyperlink enables businesses and projects to showcase their brand identity directly within the system interface. This feature combines functionality and customization, ensuring both usability and a professional presentation.

Theme settings

The Theme settings consists of two sections: Theme and Logo, each providing specific customization options to enhance usability and branding.

- **Theme**

Allows users to switch between Light and Dark interface display modes to adapt to different working environments, enhancing user comfort and reducing eye strain in varying light conditions.

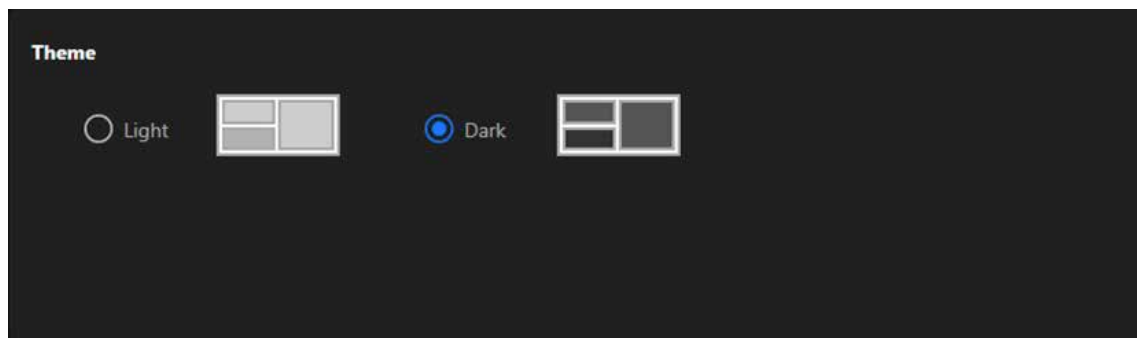

Light Mode:

Designed with a light background, ideal for bright environments.

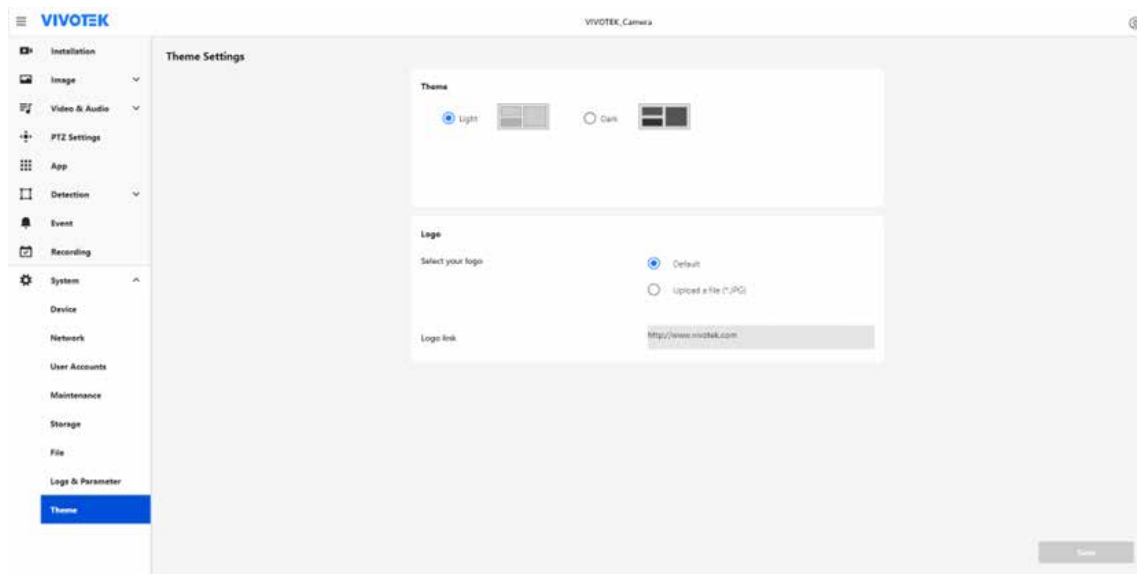

System

Dark Mode:

Uses a dark background, reducing glare and improving visibility in low-light conditions.

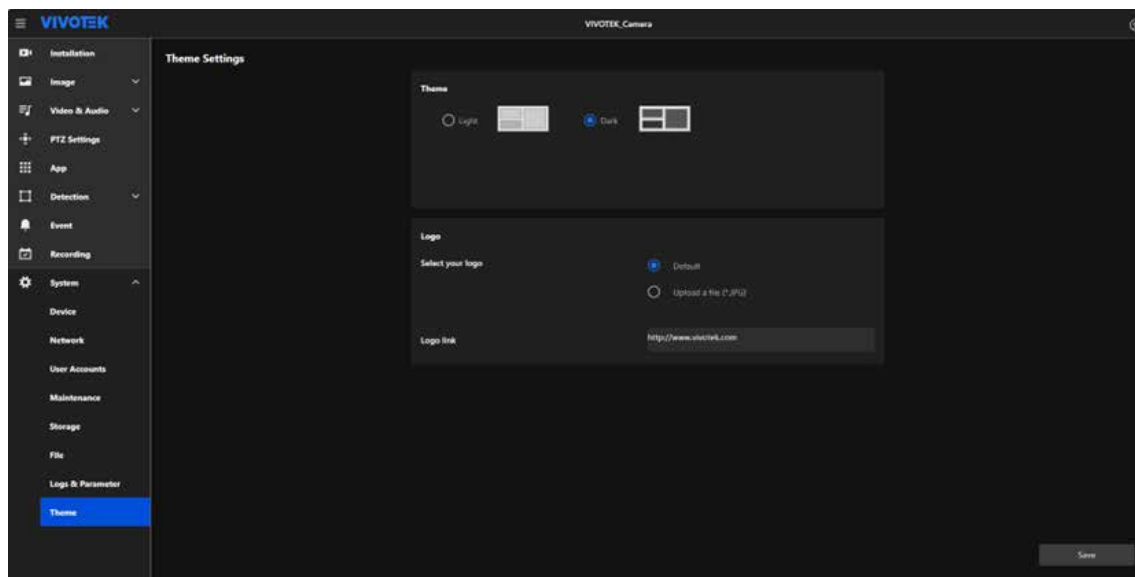

How to Operate:

Step 1. Select the desired mode (Light or Dark) by clicking the corresponding option.

Step 2. The interface preview changes dynamically to reflect the selected theme.

Step 3. Click the Save button to apply the changes.

• Logo

Enables businesses or users to personalize the interface with their custom logo, enhancing brand recognition and professionalism, while also providing the option to configure a clickable hyperlink for the logo that redirects users to a specific webpage, such as a company website or support page.

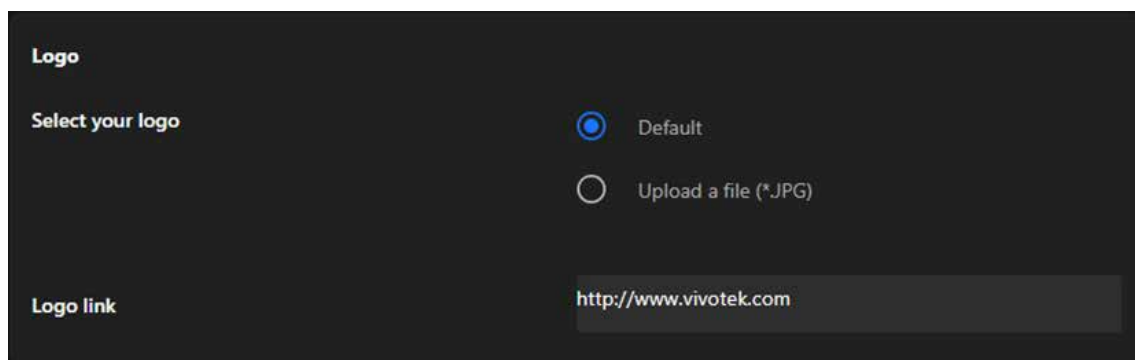

Select your logo:

Default	Uses the system's built-in default logo.
Upload a file (*.JPG)	Allows users to upload a custom logo file in JPG format for personalization.

System

Logo link:

Enables users to assign a hyperlink to the logo, redirecting to a specific webpage (e.g., company website).

Note:

Display

The selected or uploaded logo will appear on the title bar of the interface, making it visible to all users, and clicking it will redirect them to the configured URL.



Appendix A: DI/DO Configuration Guide

The DI/DO (Digital Input/Digital Output) interface in VIVOTEK cameras allows seamless integration with external devices such as relays and alarms, enabling enhanced automation and monitoring capabilities. This guide illustrates three configurations: **Dry Contact** and **Wet Contact**, each tailored to specific application needs.

1. Dry Contact with External DC Power Source

Dry contact is a safe and reliable connection method that uses an **external DC power source** to supply the relay while ensuring electrical isolation to protect connected devices.

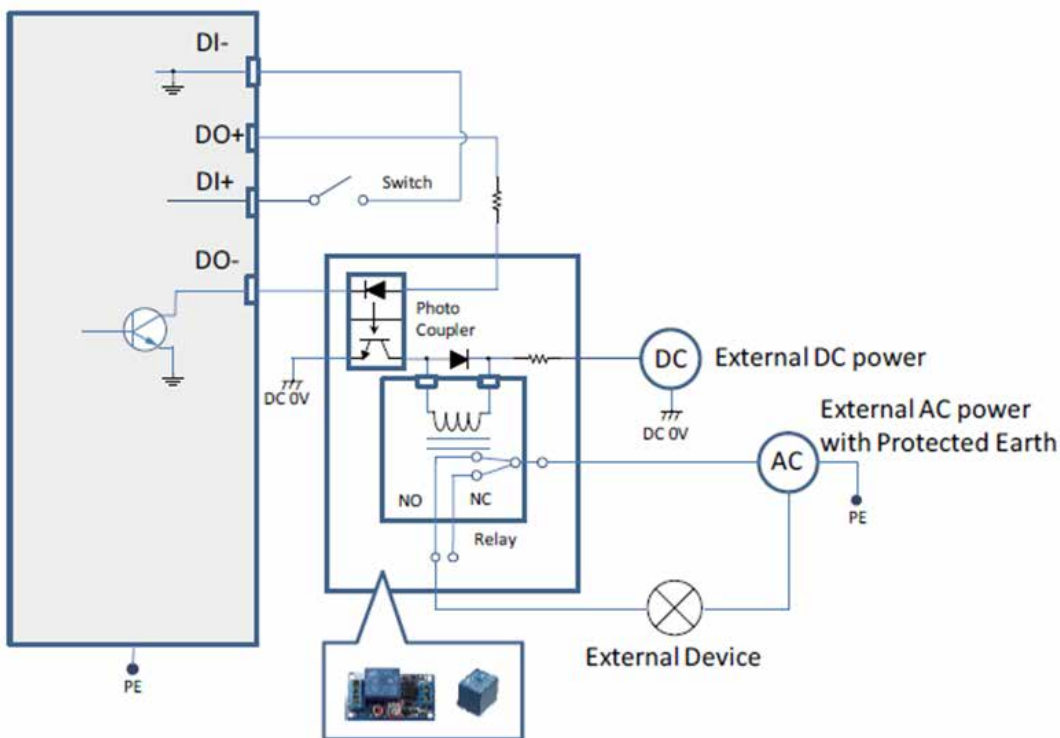

- **Key features**

The camera's **DO+ pin** controls the relay via a photocoupler, providing electrical isolation.

The relay can control an **external AC power source**, which must include a **Protected Earth (PE)** connection for safety.

Ideal for environments where the relay requires a dedicated DC power source.

Appendix A: DI/DO Configuration Guide

2. Wet Contact with External DC Power Source

Wet contact simplifies the connection by allowing the camera's **DO+ pin** to directly power the relay without requiring an additional external DC power source.

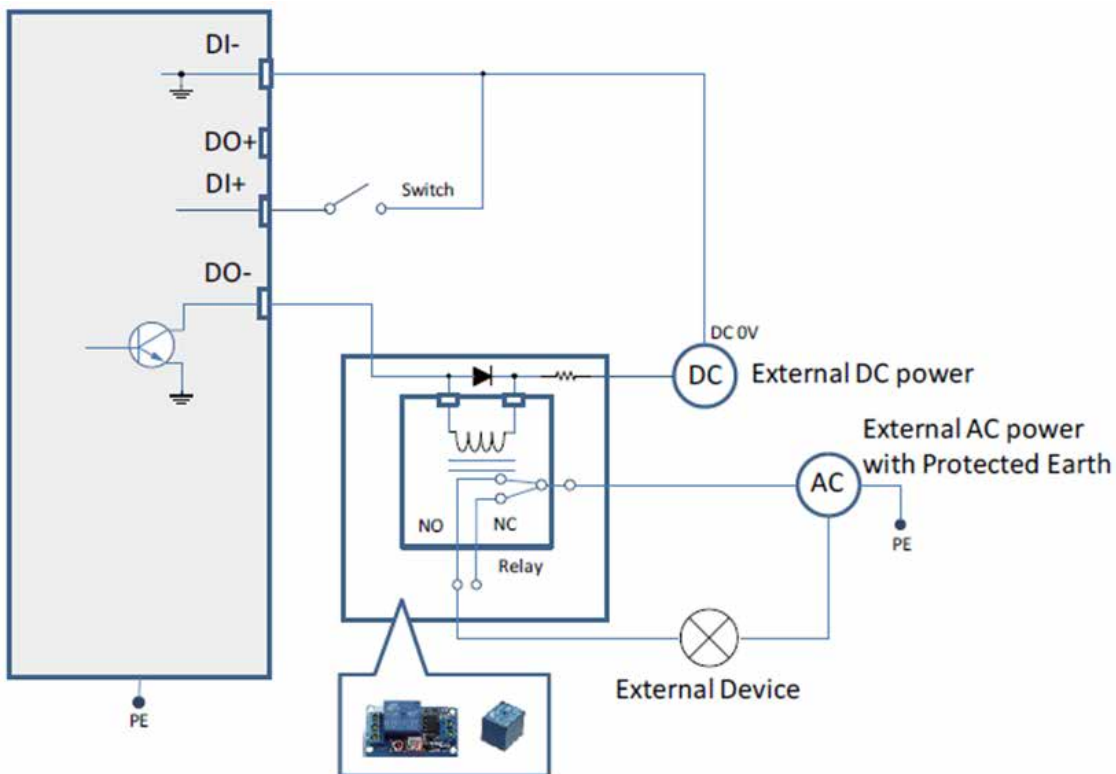

- **Key features**

The camera's **DO+ output** directly powers the relay, reducing wiring complexity.

A **transient voltage suppression diode** is recommended to protect against voltage or current spikes.

The relay can control the ON/OFF state of external AC-powered devices.

Appendix A:

DI/DO Configuration Guide

3. Dry Contact Using the Camera's DO+ Pin

This configuration also employs a dry contact setup but relies entirely on the camera's **DO+ output** to supply the relay, making it ideal for applications without an external DC power source.

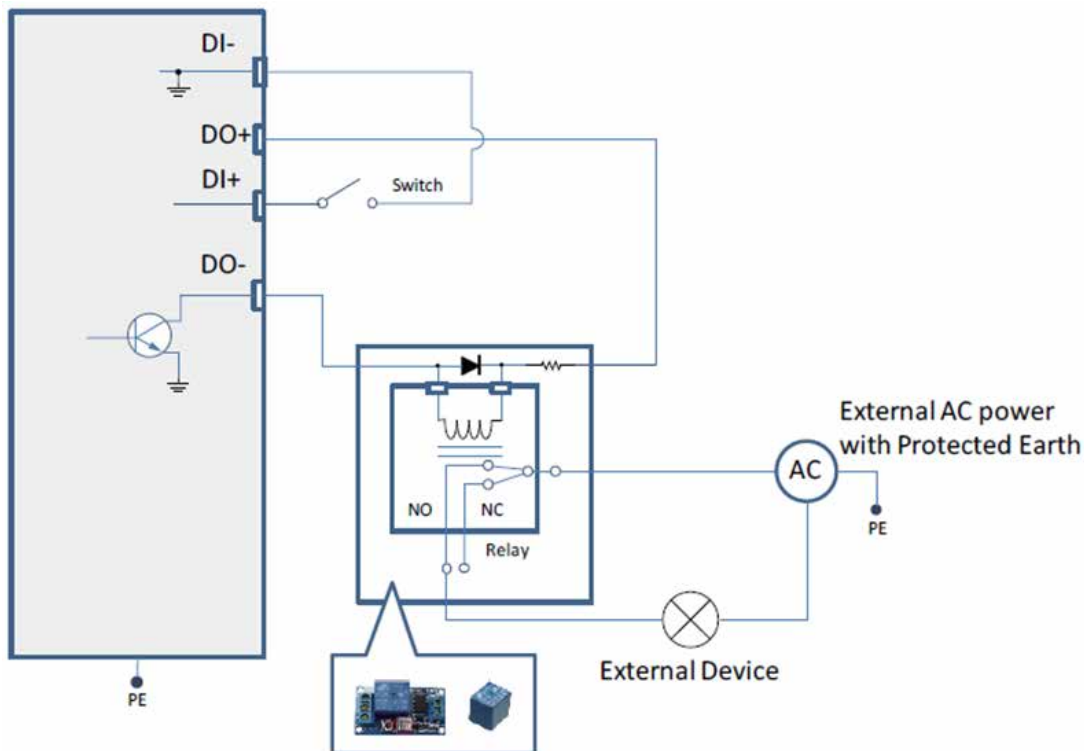

- **Key features**

The camera's **DO+ pin** provides 12V output with a maximum load of 50mA to power the relay.

The relay controls external AC-powered devices, with grounding ensured through a **Protected Earth (PE)** connection.

Simplifies wiring while requiring compatibility with the relay's specifications.

Appendix A:

DI/DO Configuration Guide

General Considerations:

1. DO+ and DO- Specifications:

DO+: Provides 12V output voltage with a maximum load of 50mA.

DO-: Supports up to 30V DC when powered by an external source.

2. Relay Compatibility:

Ensure the relay used matches the camera's output specifications.

Use a **transient voltage suppression diode** to protect against electrical spikes when using individual relays.

3. Application Flexibility:

These configurations support various applications, including triggering alarms, controlling devices.

Use a transient voltage suppression diode to protect against electrical spikes when using individual relays.

This guide provides a detailed overview of DI/DO configurations, enabling safe, reliable, and flexible integration with external devices. For further details or troubleshooting, consult the device's user manual or contact technical support.

VIVOTEK

A Delta Group Company

www.vivotek.com

DESIGN AND SPECIFICATIONS ARE SUBJECT TO CHANGE WITHOUT NOTICE
Copyright © 2024 VIVOTEK INC. All rights reserved.