



Thank you for purchasing your CB5 landscape speaker from Rockustics®. Cherry Bomb's patented three-way design includes a 5" double-chamber, band-pass sub-woofer, a 4" woofer and a .75" tweeter all in one. When properly installed, these speakers will provide years of listening enjoyment. If you have any questions that are not answered in the following directions, please contact your local sound contractor or the SoundTube Entertainment technical support team.

Site Preparation

There are several factors to consider when choosing mounting locations for your CB5 landscape speaker:

- 1) The speakers are designed to be partially buried in the ground, but the CB5 unit can also be installed by simply sitting on its base above ground.
- 2) The CB5 speaker is a full-range system with integrated sub woofer. Plan the speaker locations to provide even audio coverage and attempt to keep an even distance between each of the CB5 speakers.
- 3) It is preferred to place the CB5 speakers around, or near the perimeter of the listening area where the audio is intended to be heard.
- 4) There should be a direct line of sight from the speaker to the listening area.
- 5) Position each speaker so they are all approximately the same distance away from the listening area.
- 6) Do not place the speakers in areas that are prone to flooding with standing water.
- 7) The speakers should not be positioned directly in front of or in direct spray of sprinklers.
- 8) Do not aim the top speaker at more than 45° from horizontal to keep the unit from collecting water on the cone.

We cannot anticipate or accommodate every possible installation configuration. Trial and error methods may have to be employed to achieve acceptable audio dispersion. Included are some typical installation layouts for your reference.

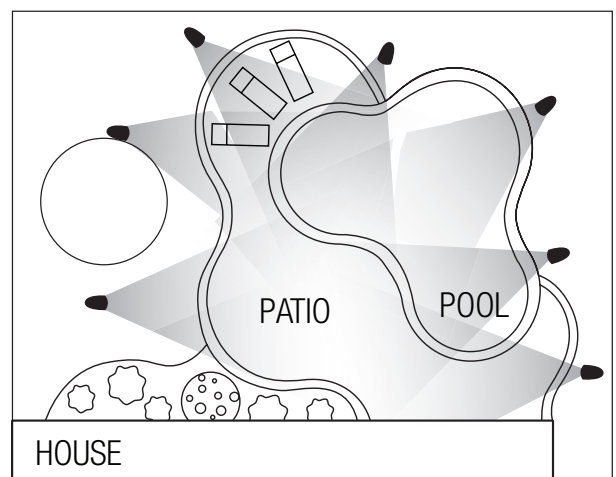
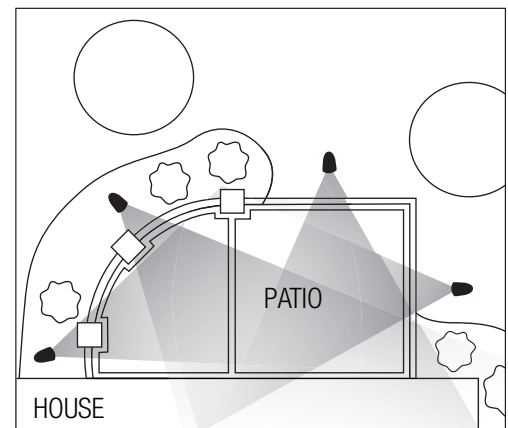

Wiring Diagram

The CB5 speakers all come equipped with high voltage (70.7V/100V*) transformers and may also be run in an 8Ω direct mode. The speaker comes with hard wire leads for the two options. See the figures below for typical high voltage (70.7V/100V*) and 8Ω wiring configurations.

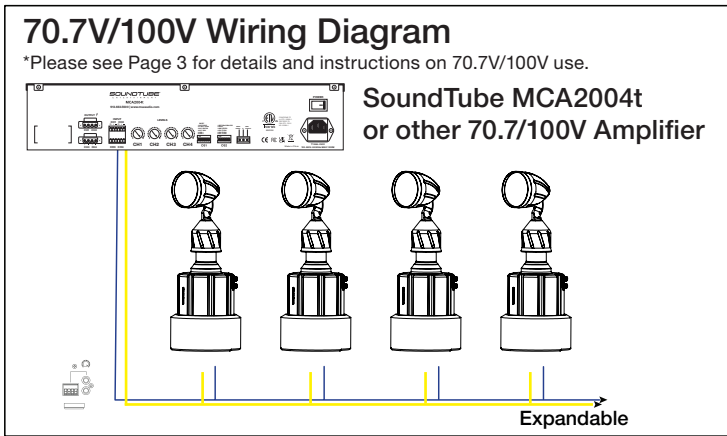
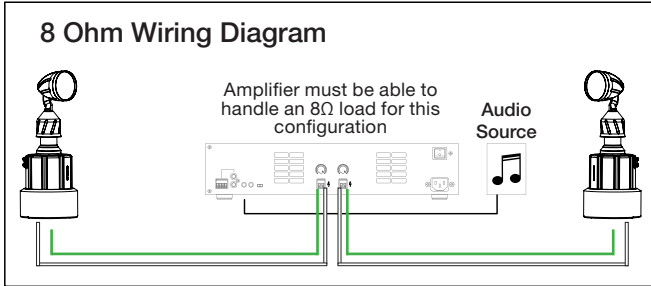

Speaker Installation

Rockustics recommends using either 14 gauge or 16 gauge direct-burial wire. It is best to lay out the wire to each of the intended speaker locations before installing the speakers.

Step-by-Step Setup

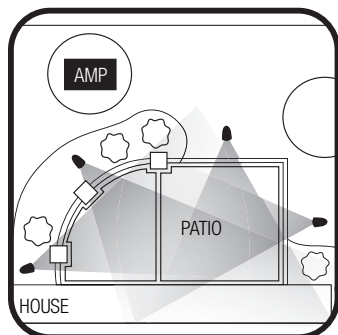

1. Layout Design

Determine the layout of your system. Place each speaker in the general location it will be installed. Also place your amplifier where it will be installed.

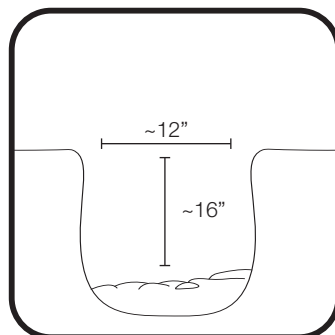

2. Digging

Dig a hole sufficient to bury the speaker(s) to the correct depth (noted above) and to also accommodate 2-3" of gravel or crushed rock under the speaker housing.

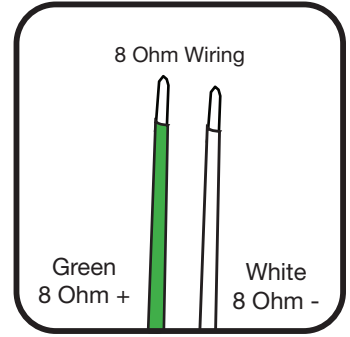
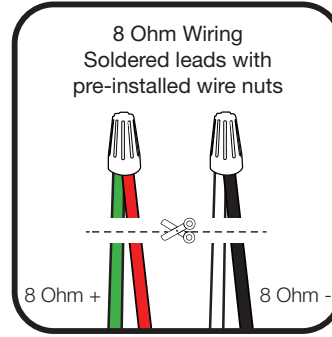

3. 8Ω Wiring

Locate the green and white wires. Disconnect the red wire from the green wire and the black wire from the white wire. Connect the positive (+) lead from the amp to the green wire on the CB5, then connect the negative (-) lead from the amp to the white wire on the CB5. **You will NOT use the red, black, yellow, or blue wires in an 8Ω installation. Simply tape or cap them off.**



4. Test

Fully wire the rest of your system and test to make sure sound is coming from each unit.

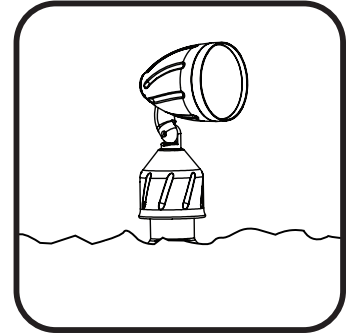

5. Bury Speakers

Place your speakers in each hole, and aim in the desired direction. Begin filling back up. Be sure the speaker is deep enough in the ground that the wire(s) can be buried at least 2" below final landscaping. Pack down the dirt.

IMPORTANT: Remember to NOT cover the port with dirt so your speaker functions properly.

PLEASE NOTE:

The dial on the back-side of the speaker head is NOT a volume knob. It is fixed in place and is NOT meant to be rotated.

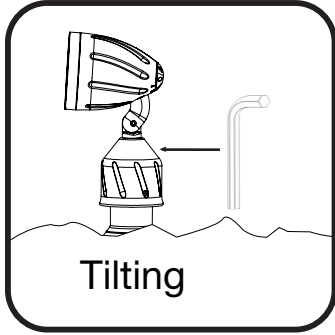

6. Fine-Tune Aiming

Angle the speakers in your desired position with the allen wrench.

Limited Warranty

Rockustics warrants its loudspeakers to be free from defects in material and workmanship for a period of ten (10) years for speaker product and three (3) years for the electronic components to the original purchaser. Purchase must be made from an authorized Rockustics dealer.

This warranty does not cover service or parts to repair damage caused by misuse, abuse, damage while in transit, alterations, unauthorized repairs, failure to follow instructions, fire, flood, or any other cause beyond the reasonable control of Rockustics. Defects in speaker cabinets or grilles must be brought to the attention of your dealer immediately after purchase. This warranty will be void if the products' serial number has been altered or removed.

Should your Rockustics product require service, please call the MSE Audio customer service department for a return authorization. All merchandise returned to Rockustics without prior authorization will be refused. For your return authorization number, please call 913.663.5600 or email sales@mseaudio.com

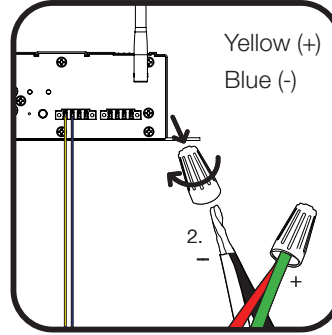

Alternative Step: 70.7V/100V Wiring

When wiring for 70.7V or 100V applications, leave the Green and Red wires tied together. Leave the Black and White wires tied together. Then find the secondary wire whip with Yellow (+) and Blue (-) wires. Newer models of the CB5* also have a Purple (+) wire. The wires correspond to the following transformer tap settings:

Wire Color	70.7V	100V
Blue	Common (-)	Common (-)
Purple	32 W	64 W
Yellow	64 W	-

*Rockustics CB5 speakers with "J23" as the first three characters, OR a letter "B" as the fourth character of the serial number have a transformer equipped for 100V applications (and a 32W tap for 70.7V). Serial numbers without "J23" or a letter "B" should not be used in a 100V configuration.

EX: SN:J230001737, SN:D23B0000123, etc.

PLEASE NOTE:

The dial on the back-side of the speaker head is NOT a volume knob. It is fixed in place and is NOT meant to be rotated.