



GETTING STARTED

- Plan where you will mount each receiver and transmitter.
 - Avoid transmitting along a length of wall, sharp angles and large obstructions.
 - Avoid mounting inside a metal enclosure.
 - Typical range is 100' line of sight.
- **Link devices to each other before installing.** See linking instructions (per application) on following pages.
 - All RIBs must be powered during Link.
- RIBWxxxB-EN3 is both a transmitter and a receiver.
- RIBWxxC-EN3 is only a receiver.
- Linking a RIB with another RIB puts the pair in Bi-directional mode.
- PHC Gateway Controller can also link with a RIB and be bi-directional.
- Relay state at power-up can be set to ON, OFF, or LAST STATE (default).
(Exception: RIBW24B-EN3 will not save last state when powered from 24Vdc).
- Each RIB can be Linked to up to 30 transmitters of any combination.

902 MHz MODEL	POWER INPUT (VAC)	CONTACT RATING (A)	TRANSMISSION SOURCE	EEP
RIBW24B-EN3	24 ac/dc	20	Dry-Contact	A5-30-02
RIBW01B-EN3	120	20	Dry-Contact	A5-30-02
RIBW208B-EN3	208	20	Dry-Contact	A5-30-02
RIBW240B-EN3	240	20	Dry-Contact	A5-30-02
RIBW277B-EN3	277	20	Dry-Contact	A5-30-02
RIBW01C-EN3	120	5	N/A	A5-30-02
RIBW02C-EN3	208-277	5	N/A	A5-30-02
WDWS-EN3	None	N/A	Contact Closure	D5-00-01
WWS2-EN3	None	N/A	Button Press	F6-02-02
WKC-EN3	None	N/A	Insert/Remove Card	F6-04-01
WVSCM-EN3	None	N/A	Occupancy Detected	A5-07-01
WVSWM-EN3	None	N/A	Occupancy Detected	A5-07-01

Functional Devices, Inc.'s EnOcean® Manufacturer ID is 0x055.

Compatible Device from other Manufacturers
PHC Gateway Controller EEP A5-38-08

BUILDING AUTOMATION APPLICATIONS

Uni-directional Mode: Only one of the RIBs must transmit.
Two RIBWxxxB-EN3 or one RIBWxxxB-EN3 and one RIBWxxC-EN3.

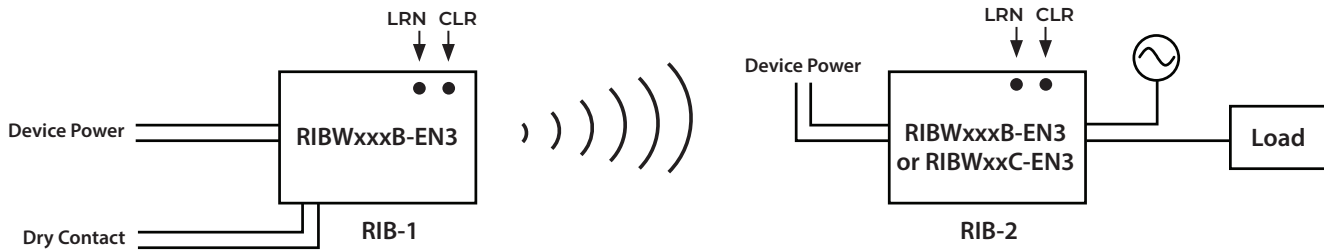

- Only one RIB is the transmitter while the other is the receiver.
- Transmitter RIB dry contact closure will transmit a relay ON command; dry contact open will transmit a relay OFF command.
- Re-transmits dry contact input state every 70-140 seconds.
- Optional modes: Repeater, Alarm (see page 4)
- When linking a RIB with Version 1.5 firmware (on product label next to logo) to a RIB with an earlier version, the Ver. 1.5 must be relay-1 in this procedure.

Uni-directional Link Procedure

1. Apply power to both RIBs.
2. Get relay-1 in Learn mode by pressing the LRN button until LED starts flashing. (approx. 1/2 second)
3. On relay-2 hold LRN button until the LED flashes once (approx. 3 seconds) to transmit a Teach telegram.
 - a. LED on relay-1 will stay ON for 4 seconds to acknowledge and then transmit a Teach telegram.
 - b. LED on relay-2 will stay ON for 4 seconds to acknowledge the Teach telegram from relay-1.

Note: 1. To clear memory, hold the CLR button for 3 seconds. The CLR LED will blink. When the LED begins blinking, disconnect both relays from power for 20-30 seconds. Then reapply power.

Bi-directional Mode: Two RIBWxxxB-EN3 or one RIBWxxxB-EN3 and a PHC Gateway Controller.

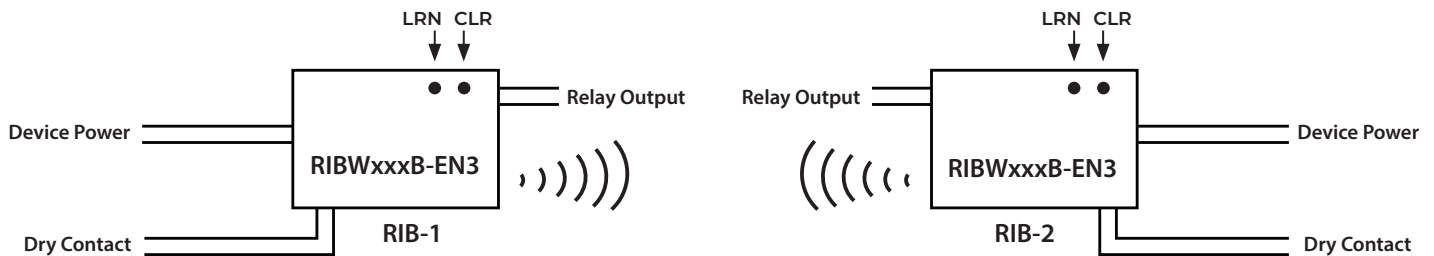

- Both devices must be able to receive and transmit.
- Dry contact closure will transmit a relay ON command; dry contact open will transmit a relay OFF command.
- RIBWxxxB-EN3 re-transmits dry contact input state every 70-140 seconds.
- Optional modes: Repeater, Alarm (see page 4)
- When linking a RIB with Version 1.5 firmware (on product label below RIB logo) to a RIB with an earlier version, the Ver. 1.5 must be relay-1 in this procedure.

Bi-directional Link Procedure

1. Apply power to both RIBs.
2. Get relay-1 in Learn mode by pressing the LRN button until LED starts flashing. (approx. 1/2 second)
3. On relay-2, hold LRN button until the LED flashes once (approx. 3 seconds) to transmit a Teach telegram.
 - a. LED on relay-1 will stay ON for 4 seconds to acknowledge and then transmit a Teach telegram.
 - b. LED on relay-2 will stay ON for 4 seconds to acknowledge the Teach telegram from relay-1.

Note: 1. To clear memory, hold the CLR button for 3 seconds. The CLR LED will blink. When the LED begins blinking, disconnect both relays from power for 20-30 seconds. Then reapply power.

LIGHTING APPLICATIONS

Simple Lighting Control: RIBWxxxB-EN3 or RIBWxxC-EN3 and WWS2-EN3 or WKC-EN3

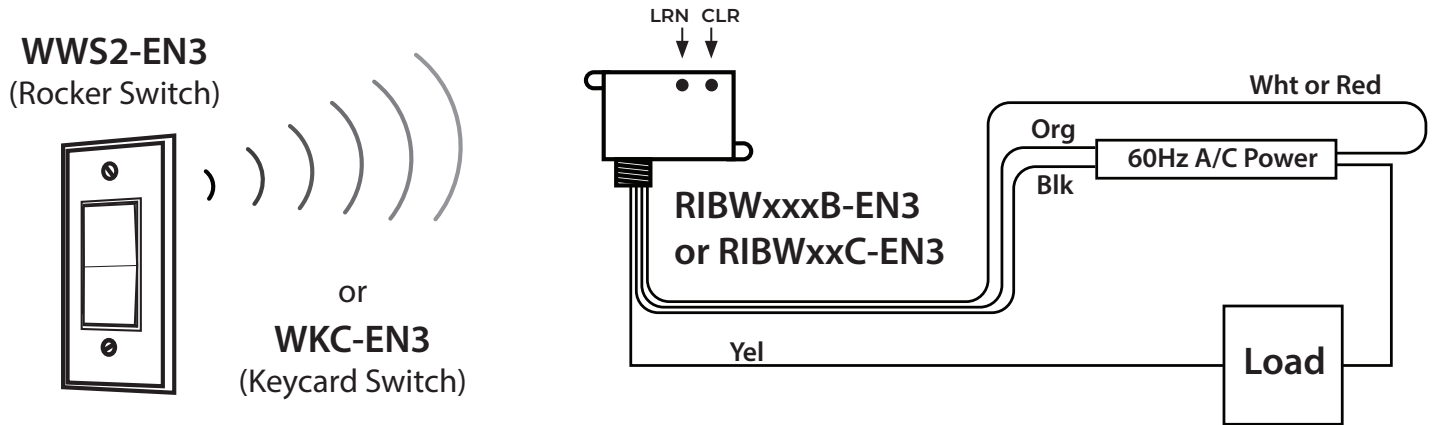

WWS2-EN3 MODES

A) ROCKER MODE

- Relay activates when Rocker ON is pressed; relay deactivates when Rocker OFF is pressed.
- Optional mode: Repeater (see page 4)

ROCKER MODE LINK PROCEDURE

1. Apply power to RIB.
2. Press and hold LRN button on RIB until LED flashes slowly (approx. 1/2 second).
3. Press and release the button on the switch you are learning three times quickly.
4. LED on RIB will stay ON for 4 seconds indicating telegram reception.
5. To learn another switch, repeat steps 2-4.

B) MOMENTARY MODE

- Relay activates while switch is pressed and deactivates when switch is released.
- Optional mode: Repeater (see page 4)

MOMENTARY MODE LINK PROCEDURE

1. Apply power to RIB.
2. Press and hold LRN button on RIB until LED flashes slowly (approx. 1/2 second).
3. Press and hold LRN button on RIB for 3 seconds until LED pattern changes to FLASH, FLASH, OFF (2 flashes).
4. Press and release the button on the switch you are learning three times quickly.
5. LED on RIB will stay ON for 4 seconds indicating telegram reception.
6. To learn another switch, repeat steps 2-5.

C) TOGGLE MODE

- Each press and release of the switch causes the relay to change state.
- Optional mode: Repeater (see page 4)

WKC-EN3 MODES

MOMENTARY MODE

- Relay activates when card is inserted and deactivates when card is removed.
- Optional mode: Repeater (see page 4)

MOMENTARY MODE LINK PROCEDURE

1. Apply power to RIB.
2. Press and hold LRN button on RIB until LED flashes slowly. (approx. 1/2 second).
3. Press and hold LRN button on RIB for 3 seconds until LED pattern changes to FLASH, FLASH, OFF (2 flashes). Press and release the button on the switch you are learning three times quickly.
4. Insert and remove the card on the switch you are learning three times quickly.
5. LED on RIB will stay ON for 4 seconds indicating telegram reception.
6. To learn another switch, repeat steps 2-5.

TOGGLE MODE LINK PROCEDURE

1. Apply power to RIB.
2. Press and hold LRN button on RIB until LED flashes slowly. (approx. 1/2 second).
3. Press and hold LRN button on RIB for 3 seconds until LED pattern changes to FLASH, FLASH, OFF (2 flashes).
4. Press and hold LRN button on RIB for 3 seconds until LED pattern changes again, to FLASH, FLASH, FLASH, OFF (3 flashes).
5. Press and release the button on the switch you are learning three times quickly.
6. LED on RIB will stay ON for 4 seconds indicating telegram reception.
7. To learn another switch, repeat steps 2-6.

OCCUPANCY DETECTION

A) MANUAL ON – AUTO OFF: RIB receiving from both an Occupancy / Vacancy Sensor (WVSWM-EN3 or WVSCM-EN3) and a Wall Switch (WWS2-EN3)

- Relay activates when Rocker ON is pressed. Relay deactivates when Rocker OFF is pressed or 30 minutes after last detection of occupancy.
- It may take up to 2 minutes for the RIB to respond to the Occupancy / Vacancy Sensor immediately following Link.
- Optional mode: Repeater (see page 4)

MANUAL ON – AUTO OFF LEARN PROCEDURE

1. Be sure the Occupancy / Vacancy Sensor is charged
2. Apply power to RIB.
3. Press and hold LRN button on RIB until LED flashes slowly (approx. 1/2 second).
4. Trigger a Teach telegram from the Occupancy / Vacancy Sensor by pressing the Menu button once.
5. LED on RIB will stay ON for 4 seconds acknowledging telegram reception.
6. Press and hold LRN button on RIB for 1/2 second. LED will flash slowly.
7. Press and release rocker switch three times quickly.
8. LED on RIB will stay ON for 4 seconds acknowledging telegram reception.
9. To learn another switch, repeat steps 6-8.

B) AUTO ON: RIB and an Occupancy / Vacancy Sensor (WVSWM-EN3 or WVSCM-EN3)

- Relay activates when occupancy is detected and deactivates 30 minutes after last detection of occupancy.
- It may take up to 2 minutes for the RIB to respond to the Occupancy / Vacancy Sensor immediately following Link.
- Optional mode: Repeater (see page 4)

OCCUPANCY / VACANCY SENSOR ONLY LEARN PROCEDURE

1. Charge the Occupancy / Vacancy Sensor per instructions.
2. Apply power to RIB.
3. Press and hold LRN button on RIB until LED flashes slowly. (approx. 1/2 second)
4. Trigger a Teach telegram from the Occupancy / Vacancy Sensor by pressing the Menu button once.
5. LED on RIB will stay ON for 4 seconds acknowledging telegram reception.
6. Repeat steps 3-5 for additional Occupancy / Vacancy Sensors.

OPTIONAL MODES

RELAY STATE

- Relay state after power-up can be set to ON, OFF or LAST STATE
- Relay state after power-up is LAST STATE by default.

Setting Relay State to OFF at Power-up:

1. While device is not powered, press and hold the LRN button.
 2. Power-up the device.
 3. Wait approximately 3 seconds until the LED blinks 3 times.
 4. Release the LRN button.
- Relay will always be OFF at power-up.

Setting Relay State to ON at Power-up:

1. While device is not powered, press and hold the CLR button.
 2. Power-up the device.
 3. Wait approximately 3 seconds until the LED blinks 2 times.
 4. Release the CLR button.
- Relay will always be ON at power-up.

Setting Relay State to LAST STATE at Power-up: (Default Mode) **

1. While device is not powered, press and hold the LRN and CLR buttons.
 2. Power-up the device.
 3. Wait approximately 3 seconds until the LED blinks 1 time.
 4. Release the LRN and CLR buttons.
- Relay will return to LAST STATE at power-up.

****NOTE:** LAST STATE does not work with RIBW24B-EN3 when powered from 24 Vdc.

REPEATER MODE

- Activating Repeater Mode allows RIB to repeat signals from other EnOcean devices within range. The RIB “hears” the signal and echoes it but will not respond to it unless it has been linked to the transmitting device.
- RIB will allow a signal to be repeated up to two times.

ENABLING REPEATER MODE

1. Apply power to RIB.
2. Press and hold LRN button on RIB until LED flashes slowly (approx. 1/2 second).
3. Press and hold the CLR button for 3 seconds until LED flashes twice indicating Repeater Mode is enabled.

DISABLING REPEATER MODE

1. Apply power to RIB.
2. Press and hold LRN button on RIB until LED flashes slowly (approx. 1/2 second).
3. Press and hold the CLR button for 3 seconds until LED flashes three times indicating Repeater Mode is disabled.

ALARM MODE

- Activating Alarm Mode requires all learned contact switches, such as WDWS-EN3 or RIBWxxxB-EN3, to transmit a CLOSED telegram before relay will activate. Relay will deactivate if any contact switch transmits an OPEN telegram.

ENABLING ALARM MODE

1. Apply power to RIB.
2. Press and hold LRN button on RIB until LED flashes slowly (approx. 1/2 second).
3. Press and hold LRN button on RIB for 3 seconds until LED pattern changes to FLASH, FLASH, OFF (2 flashes).
4. Press and hold the CLR button for 3 seconds until LED flashes twice indicating Alarm Mode is enabled.

DISABLING ALARM MODE

1. Apply power to RIB.
2. Press and hold LRN button on RIB until LED flashes slowly (approx. 1/2 second).
3. Press and hold LRN button on RIB for 3 seconds until LED pattern changes to FLASH, FLASH, OFF (2 flashes).
4. Press and hold the CLR button for 3 seconds until LED flashes three times indicating Alarm Mode is disabled.

DELAY MODE

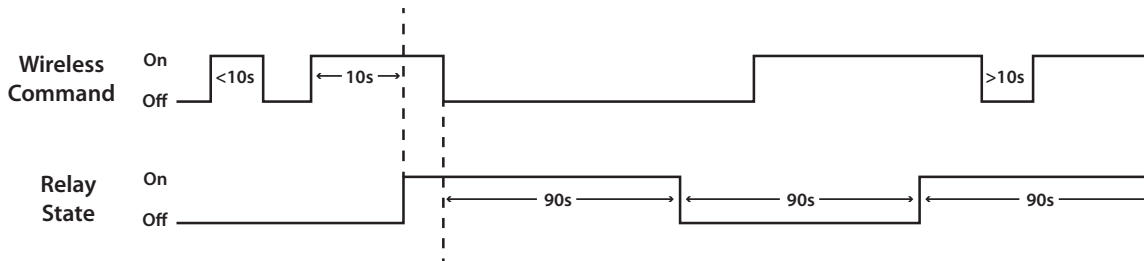

- Activating Alarm Mode requires all learned contact switches, such as WDWS-EN3 or RIBWxxxB-EN3, to transmit a CLOSED telegram before relay will activate. Relay will deactivate if any contact switch transmits an OPEN telegram.
- Typically used with Hotel Room Energy Control (see page 6).
- Activating Delay Mode allows the RIB to ignore temporary changes in switch states.
- The Delay Mode causes a delay of 10 seconds before relay will turn ON and a delay of 90 seconds before it will turn OFF. It also prevents the relay from activating following a deactivation for 90 seconds (see Figure 4, below).
- The OFF delay allows the load to continue to run while the switch or transmitter is temporarily open. This is helpful when monitoring window and door contacts that may be briefly opened and then closed. If the contact remains open for longer than 90 seconds the relay will deactivate.
- The ON delay prevents the relay from immediately responding to a closed contact.
- The 90 second OFF to ON delay is intended specifically for HVAC units so that they will not short cycle.

ENABLING DELAY MODE

1. Apply power to RIB.
2. Press and hold LRN button on RIB until LED flashes slowly (approx. 1/2 second).
3. Press and hold LRN button on RIB for 3 seconds until LED pattern changes to FLASH, FLASH, OFF (2 flashes).
4. Press and hold LRN button on RIB for 3 seconds until LED pattern changes again, to FLASH, FLASH, FLASH, OFF (3 flashes).
5. Press and hold the CLR button for 3 seconds until LED flashes twice indicating Delay Mode is enabled.

DISABLING DELAY MODE

1. Apply power to RIB.
2. Press and hold LRN button on RIB until LED flashes slowly (approx. 1/2 second).
3. Press and hold LRN button on RIB for 3 seconds until LED pattern changes to FLASH, FLASH, OFF (2 flashes).
4. Press and hold LRN button on RIB for 3 seconds until LED pattern changes again, to FLASH, FLASH, FLASH, OFF (3 flashes).
5. Press and hold the CLR button for 3 seconds until LED flashes three times indicating Delay Mode is disabled.

CLEARING ID'S FROM MEMORY

GLOBAL CLEAR (RESET TO DEFAULT SETTINGS)

- Clears all linked devices, disables optional modes, and turns relay OFF.

Press and hold CLR button on RIB for 3 seconds until LED begins slowly flashing. Clear Mode will time out and exit in 30 seconds.

SINGLE DEVICE CLEAR

- Allows the user to Un-link a single transmitter from RIB.
- Maintains all optional mode settings.

Repeating the Link procedure for a currently Linked device will Un-link that device.

ENERGY SAVING APPLICATIONS

RIB with Door/Window Sensor(s) WDWS-EN3

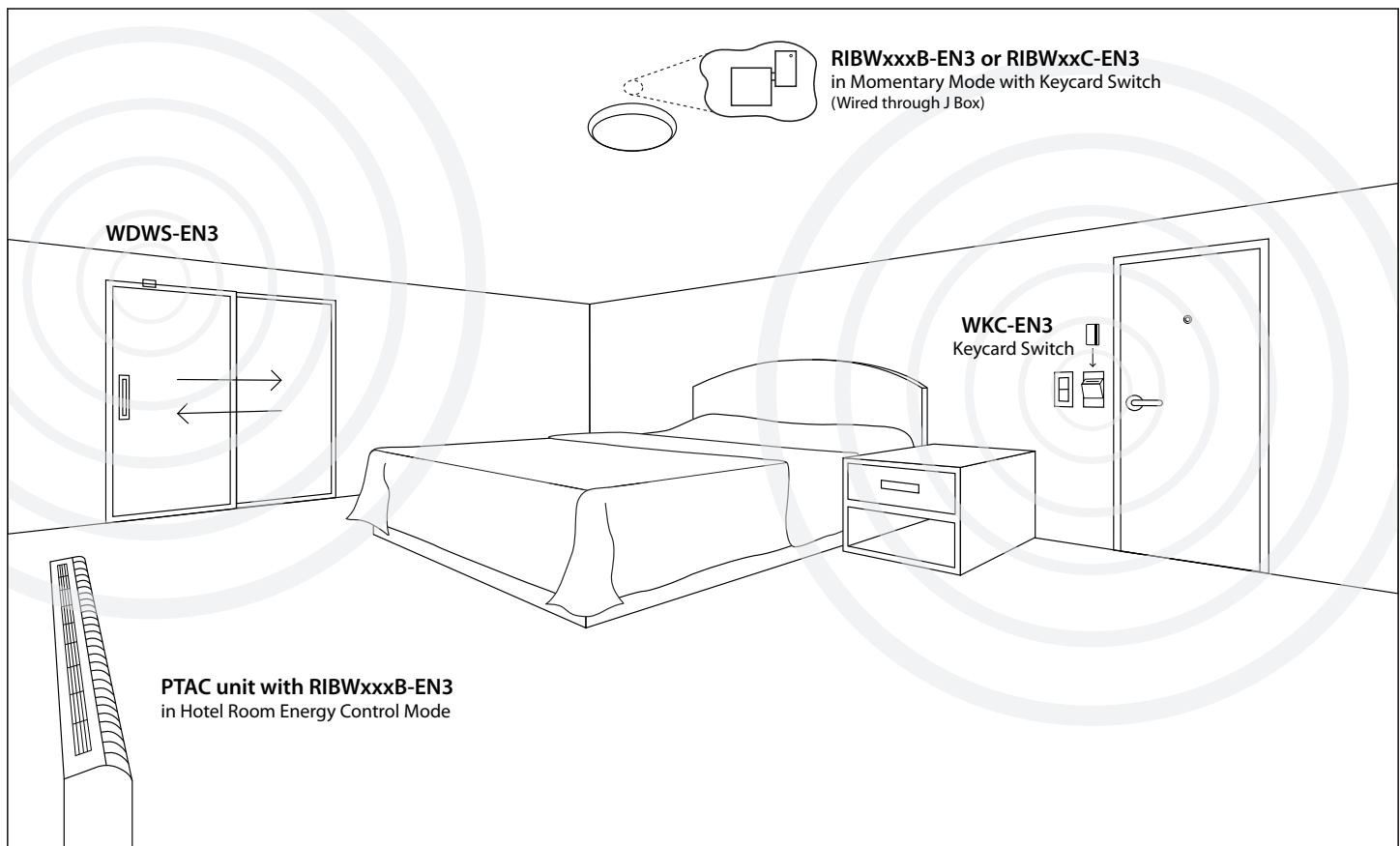

- Relay activates with closed command from WDWS-EN3 and deactivates with open command.
- WDWS-EN3 retransmits contact state every 20-30 minutes.
- Optional modes:
Repeater, Alarm (see page 5)
Delay (see page 5)

WDWS-EN3 LINK PROCEDURE

1. Charge the WDWS-EN3 per Instructions provided with unit.
2. Apply power to RIB.
3. Press and hold LRN button on RIB until LED flashes slowly (approx. 1/2 second).
4. Press and release Link button on WDWS-EN3 to transmit Teach telegram.
5. LED on RIB will stay ON for 4 seconds acknowledging telegram reception.
6. To learn more WDWS-EN3, repeat steps 3-5.

Hotel Room Energy Control RIB with WDWS-EN3 and WKC-EN3- **CONSULT FACTORY**

OTHER COMMON APPLICATIONS

Unidirectional Control with a BAS System

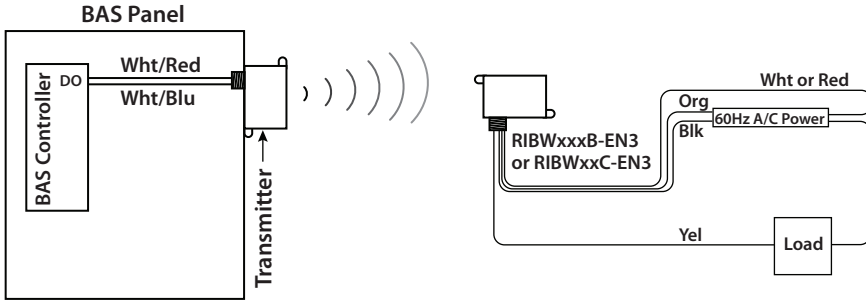

In this application the BAS system dry-contact output controls the transmitter and a RIBWxxxB-EN3 or RIBWxxC-EN3 is the receiver.

Unidirectional Control with a Thermostat

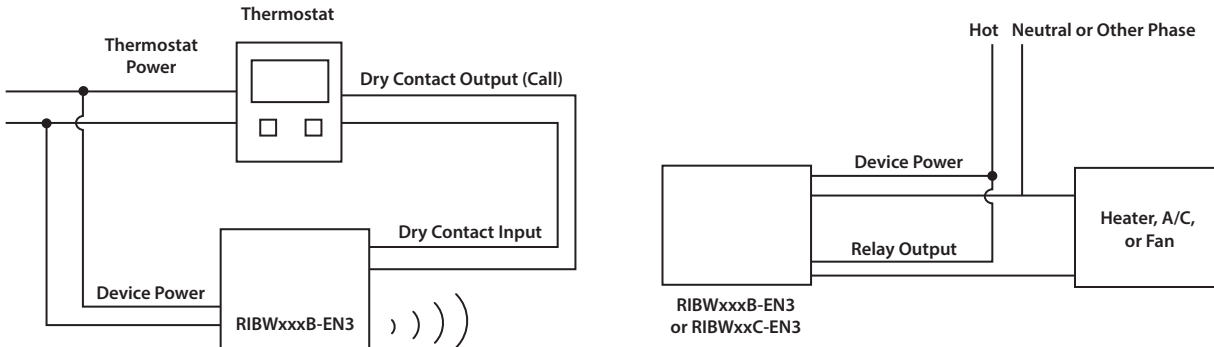

In this application the thermostat dry-contact output controls the transmitter and a RIBWxxxB-EN3 or RIBWxxC-EN3 is the receiver.

Bidirectional Control with a BAS System

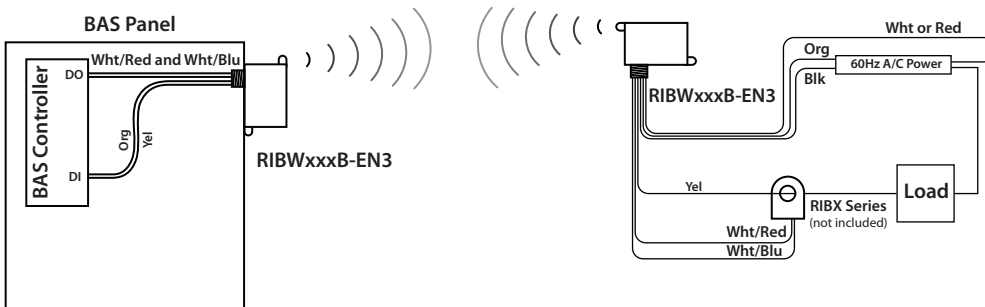

In this application the BAS system dry-contact output controls the transmitter on a RIBWxxxB-EN3. A second RIBWxxxB-EN3 receives the signal and activates its relay. A current switch detects current flow through the load and closes the dry-contact input on the second RIBWxxxB-EN3. The first RIBWxxxB-EN3 receives the transmission and closes its relay. This contact closure to the BAS system lets the controller know the load status.