

# RIB Series

riser bases

RIB Series Riser bases provide advanced cable management

## features:

- 1/8" thick fully welded construction
- Riser bases allow for field rough-in prior to arrival of racks and enclosures
- Riser bases act as a lower cable chase for passing cables between racks in multi-bay installations
- Ideal for use in raised floor installations when used with optional VFEET and ANGLE / WANGLE / DANGLE / WMANGLE / BANGLE / SANGLE
- Available in custom widths, depths, heights and configurations
- Durable black textured powder coat finish

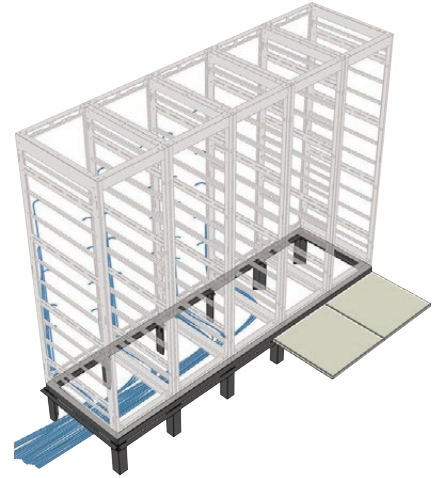

## specifications:

Riser base shall be Middle Atlantic Products model # RIB-\_\_-\_\_-\_\_ (see chart for available models) to accommodate \_\_ qty (refer to chart) \_\_ (WRK / DRK / MRK / VRK / VMRK / BGR / WMRK / SNE) Series \_\_" depth racks. Riser base shall be constructed of 11-gauge steel. Riser base shall be 2-1/2" H x \_\_" W x \_\_" D (refer to chart). Riser base shall have one knockout on each side for cable pass-through measuring 1.71" H x \_\_" W (refer to chart for width dimension). Riser bases shall be phosphate pre-treated and finished a durable textured black powder coat. Riser base shall be warranted to be free from defects in material or workmanship under normal use and conditions for the lifetime of the product.

\* Seismic Riser base option available (see SRB Spec Sheet 96-01027)

Customizable specification clips available at [middleatlantic.com](http://middleatlantic.com)

## options:

Raised floor riser feet shall be Middle Atlantic Products model # VFEET-\_\_-12 for \_\_ (refer to chart on page 3) bay installations for use with \_\_ (refer to chart on page 3) bay RIB series riser base. Raised floor riser feet shall be 11.5" tall, constructed of 11-gauge steel, and designed for 12" raised floors. Raised floor riser feet shall be phosphate pre-treated and finished in a durable black powder coat.

Support angles shall be Middle Atlantic Products model # ANGLE-\_\_-\_\_ (for use when mounting MRK / VRK / VMRK Series racks) (refer to chart on page 4) / WANGLE-\_\_ (for use when mounting WRK Series racks) (refer to chart) for use with \_\_ (refer to chart on page 4) / DANGLE-\_\_ (for use when mounting DRK Series Racks) (refer to chart) / WMANGLE-\_\_ (for use when mounting WMRK Series Racks) (refer to chart) / BANGLE-\_\_ (for use when mounting BGR Series Racks) / SANGLE-\_\_ (for use when mounting SNE Series Racks) (refer to chart). Support angles shall be constructed from 11-gauge steel. Support angles shall be phosphate pre-treated and finished in a durable black powder coat.

what **great systems** are built on.™

A brand of **legrand**

**Middle Atlantic Products**

[middleatlantic.com](http://middleatlantic.com) | [middleatlantic.ca](http://middleatlantic.ca)

96-923 / rev i / 5-12-20

# VFEET Raised Floor

## basic dimensions

all dimensions in inches unless otherwise noted [all dimensions in brackets are in millimeters]

bottom view

(riser base shown upside down to show VFEET positioning)

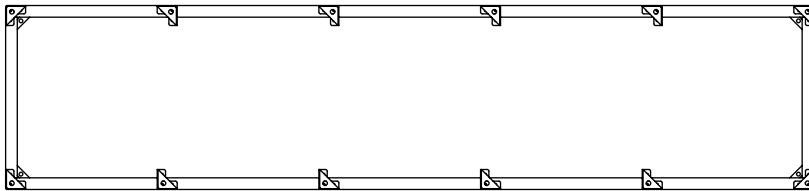

side view

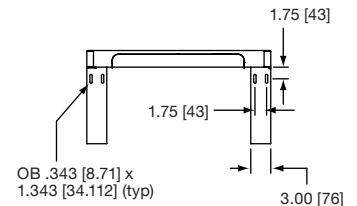

front view

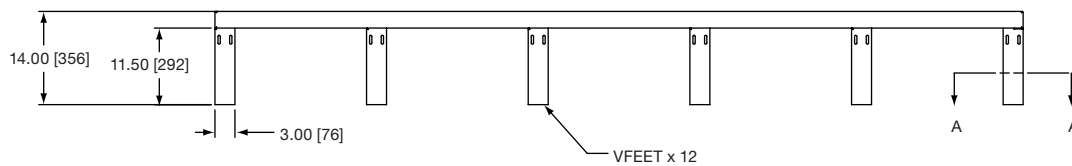

section A-A

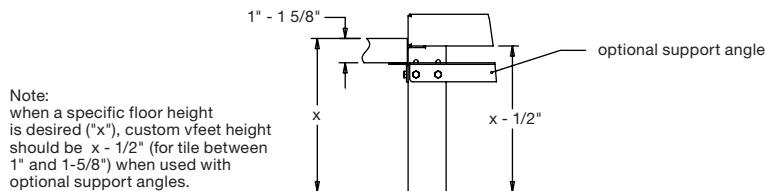

0.69 [17.53] floor mounting holes in VFEET x 12

VFEET raised floor riser feet			
Part #	# of Feet	Used On	# of Racks Accommodated
VFEET-1-12	4	RIB-1	1
VFEET-2-12	6	RIB-2	2
VFEET-3-12	8	RIB-3	3
VFEET-4-12	10	RIB-4	4
VFEET-5-12	12	RIB-5	5

what **great systems** are built on.™

A brand of **legrand**

**Middle Atlantic Products**  
middleatlantic.com | middleatlantic.ca

# RIB Series Riser Bases

## basic dimensions

all dimensions in inches unless otherwise noted [all dimensions in brackets are in millimeters]

Part #	A Overall Width	B Overall Depth	C Floor Mounting Holes	D Floor Mounting Holes	E Knockout Width	# of Racks Accommodated
RIB-1-WRK-27	24.25 [616]	27.63 [702]	19.65 [499]	23.00 [584]	16.10 [409]	1
RIB-2-WRK-27	48.53 [1233]	27.63 [702]	43.93 [1116]	23.00 [584]	16.10 [409]	2
RIB-3-WRK-27	72.81 [1849]	27.63 [702]	68.21 [1733]	23.00 [584]	16.10 [409]	3
RIB-4-WRK-27	97.09 [2466]	27.63 [702]	92.49 [2349]	23.00 [584]	16.10 [409]	4
RIB-5-WRK-27	121.37 [3083]	27.63 [702]	116.77 [2966]	23.00 [584]	16.10 [409]	5
RIB-1-WRK-32	24.25 [616]	32.63 [829]	19.65 [499]	28.00 [711]	21.10 [536]	1
RIB-2-WRK-32	48.53 [1233]	32.63 [829]	43.93 [1116]	28.00 [711]	21.10 [536]	2
RIB-3-WRK-32	72.81 [1849]	32.63 [829]	68.21 [1733]	28.00 [711]	21.10 [536]	3
RIB-4-WRK-32	97.09 [2466]	32.63 [829]	92.49 [2349]	28.00 [711]	21.10 [536]	4
RIB-5-WRK-32	121.37 [3083]	32.63 [829]	116.77 [2966]	28.00 [711]	21.10 [536]	5
RIB-1-DRK-31	30.00 [762]	31.40 [789]	25.40 [645]	26.80 [681]	19.87 [508]	1
RIB-2-DRK-31	60.03 [1525]	31.40 [789]	55.43 [1408]	26.80 [681]	19.87 [508]	2
RIB-3-DRK-31	90.06 [2288]	31.40 [789]	85.46 [2171]	26.80 [681]	19.87 [508]	3
RIB-1-DRK-36	30.00 [762]	36.00 [914]	25.40 [645]	31.40 [798]	24.47 [622]	1
RIB-2-DRK-36	60.03 [1525]	36.00 [914]	55.43 [1408]	31.40 [798]	24.47 [622]	2
RIB-3-DRK-36	90.06 [2288]	36.00 [914]	85.46 [2171]	31.40 [798]	24.47 [622]	3
RIB-1-DRK-42	30.00 [762]	42.00 [1067]	25.40 [645]	37.40 [950]	30.47 [774]	1
RIB-2-DRK-42	60.03 [1525]	42.00 [1067]	55.43 [1408]	37.40 [950]	30.47 [774]	2
RIB-3-DRK-42	90.06 [2288]	42.00 [1067]	85.46 [2171]	37.40 [950]	30.47 [774]	3
RIB-1-WMRK-36	23.94 [608]	36.00 [914]	19.34 [491]	31.40 [797]	24.47 [622]	1
RIB-2-WMRK-36	47.91 [1217]	36.00 [914]	43.30 [1100]	31.40 [797]	24.47 [622]	2
RIB-3-WMRK-36	71.87 [1826]	36.00 [914]	67.27 [1709]	31.40 [797]	24.47 [622]	3
RIB-1-WMRK-42	23.94 [608]	42.00 [1067]	19.34 [491]	37.40 [950]	30.47 [774]	1
RIB-2-WMRK-42	47.91 [1217]	42.00 [1067]	43.30 [1100]	37.40 [950]	30.47 [774]	2
RIB-3-WMRK-42	71.87 [1826]	42.00 [1067]	67.27 [1709]	37.40 [950]	30.47 [774]	3
RIB-1-WMRK-48	23.94 [608]	48.00 [1219]	19.34 [491]	43.40 [1102]	36.47 [926]	1
RIB-2-WMRK-48	47.91 [1217]	48.00 [1219]	43.30 [1100]	43.40 [1102]	36.47 [926]	2
RIB-3-WMRK-48	71.87 [1826]	48.00 [1219]	67.27 [1709]	43.40 [1102]	36.47 [926]	3
RIB-1-MRK-26	22.00 [559]	26.40 [671]	17.40 [442]	21.80 [554]	14.87 [378]	1
RIB-2-MRK-26	44.03 [1118]	26.40 [671]	39.43 [1002]	21.80 [554]	14.87 [378]	2
RIB-3-MRK-26	66.06 [1678]	26.40 [671]	61.46 [1561]	21.80 [554]	14.87 [378]	3
RIB-4-MRK-26	88.09 [2237]	26.40 [671]	83.49 [2121]	21.80 [554]	14.87 [378]	4
RIB-5-MRK-26	110.12 [2797]	26.40 [671]	105.52 [2680]	21.80 [554]	14.87 [378]	5
RIB-1-MRK-31	22.00 [559]	31.40 [798]	17.40 [442]	26.80 [681]	19.87 [505]	1
RIB-2-MRK-31	44.03 [1118]	31.40 [798]	39.43 [1002]	26.80 [681]	19.87 [505]	2
RIB-3-MRK-31	66.06 [1678]	31.40 [798]	61.46 [1561]	26.80 [681]	19.87 [505]	3
RIB-4-MRK-31	88.09 [2237]	31.40 [798]	83.49 [2121]	26.80 [681]	19.87 [505]	4
RIB-5-MRK-31	110.12 [2797]	31.40 [798]	105.52 [2680]	26.80 [681]	19.87 [505]	5
RIB-1-MRK-36	22.00 [559]	36.00 [914]	17.40 [442]	31.40 [798]	24.47 [622]	1
RIB-2-MRK-36	44.03 [1118]	36.00 [914]	39.43 [1002]	31.40 [798]	24.47 [622]	2
RIB-3-MRK-36	66.06 [1678]	36.00 [914]	61.46 [1561]	31.40 [798]	24.47 [622]	3
RIB-4-MRK-36	88.09 [2237]	36.00 [914]	83.49 [2121]	31.40 [798]	24.47 [622]	4
RIB-5-MRK-36	110.12 [2797]	36.00 [914]	105.52 [2680]	31.40 [798]	24.47 [622]	5
RIB-1-MRK-42	22.00 [559]	42.00 [1067]	17.40 [442]	37.40 [950]	30.47 [774]	1
RIB-2-MRK-42	44.03 [1118]	42.00 [1067]	39.43 [1002]	37.40 [950]	30.47 [774]	2
RIB-3-MRK-42	66.06 [1678]	42.00 [1067]	61.46 [1561]	37.40 [950]	30.47 [774]	3
RIB-1-BGR-27	23.0 [584]	27.0 [686]	18.62 [473]	21.18 [538]	15.47 [393]	1
RIB-1-BGR-32	23.0 [584]	32.0 [813]	18.62 [473]	26.18 [665]	20.47 [520]	1
RIB-1-BGR-38	23.0 [584]	38.0 [965]	18.62 [473]	32.18 [817]	26.47 [672]	1
RIB-2-BGR-27	46.03 [1169]	27.0 [686]	41.65 [1058]	21.18 [538]	15.47 [393]	2
RIB-2-BGR-32	46.03 [1169]	32.0 [813]	41.65 [1058]	26.18 [665]	20.47 [520]	2
RIB-2-BGR-38	46.03 [1169]	38.0 [965]	41.65 [1058]	32.18 [817]	26.47 [672]	2
RIB-3-BGR-27	69.06 [1754]	27.0 [686]	64.68 [1643]	21.18 [538]	15.47 [393]	3
RIB-3-BGR-32	69.06 [1754]	32.0 [813]	64.68 [1643]	26.18 [665]	20.47 [520]	3
RIB-3-BGR-38	69.06 [1754]	38.0 [965]	64.68 [1643]	32.18 [817]	26.47 [672]	3
RIB-4-BGR-27	92.09 [2339]	27.0 [686]	87.71 [2228]	21.18 [538]	15.47 [393]	4
RIB-4-BGR-32	92.09 [2339]	32.0 [813]	87.71 [2228]	26.18 [665]	20.47 [520]	4
RIB-4-BGR-38	92.09 [2339]	38.0 [965]	87.71 [2228]	32.18 [817]	26.47 [672]	4
RIB-5-BGR-27	115.12 [2924]	27.0 [686]	110.74 [2813]	21.18 [538]	15.47 [393]	5
RIB-5-BGR-32	115.12 [2924]	32.0 [813]	110.74 [2813]	26.18 [665]	20.47 [520]	5
RIB-5-BGR-38	115.12 [2924]	38.0 [965]	110.74 [2813]	32.18 [817]	26.47 [672]	5

5 bay

top view

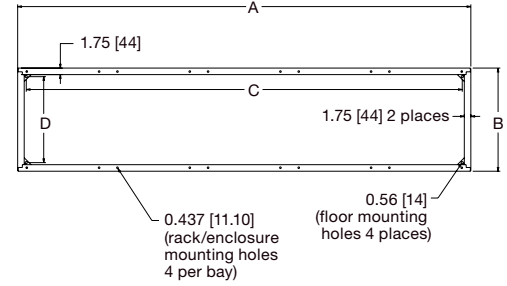

front view

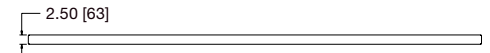

side view

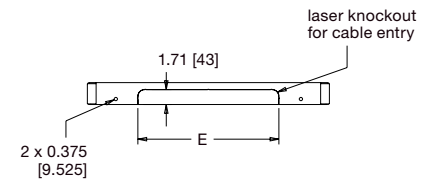

what great systems are built on.™

A brand of **legrand**

**MA**

**Middle Atlantic Products**

middleatlantic.com | middleatlantic.ca

# Raised Floor Support Angles

## basic dimensions

all dimensions in inches unless otherwise noted [all dimensions in brackets are in millimeters]

Part #	A Overall Width	B Overall Depth	Used On	Rack Series	# of Racks Accommodated
ANGLE-1	21.75 [552]	29.15 [740]	VFEET-1-12	MRK/VRK/VMRK 26" and 31" depth racks	1
ANGLE-2	43.78 [1112]	29.15 [740]	VFEET-2-12	MRK/VRK/VMRK 26" and 31" depth racks	2
ANGLE-3	65.81 [1672]	29.15 [740]	VFEET-3-12	MRK/VRK/VMRK 26" and 31" depth racks	3
ANGLE-4	87.84 [2231]	29.15 [740]	VFEET-4-12	MRK/VRK/VMRK 26" and 31" depth racks	4
ANGLE-5	109.87 [2791]	29.15 [740]	VFEET-5-12	MRK/VRK/VMRK 26" and 31" depth racks	5
ANGLE-1-36	21.75 [552]	38.75 [984]	VFEET-1-12	MRK/VRK/VMRK 36" depth racks	1
ANGLE-2-36	43.78 [1112]	38.75 [984]	VFEET-2-12	MRK/VRK/VMRK 36" depth racks	2
ANGLE-3-36	65.81 [1672]	38.75 [984]	VFEET-3-12	MRK/VRK/VMRK 36" depth racks	3
ANGLE-4-36	87.84 [2231]	38.75 [984]	VFEET-4-12	MRK/VRK/VMRK 36" depth racks	4
ANGLE-5-36	109.87 [2791]	38.75 [984]	VFEET-5-12	MRK/VRK/VMRK 36" depth racks	5
DANGLE-1-31	29.75 [756]	29.15 [740]	VFEET-1-12	DRK 31" depth racks	1
DANGLE-2-31	59.78 [1518]	29.15 [740]	VFEET-2-12	DRK 31" depth racks	2
DANGLE-3-31	89.91 [2284]	29.15 [740]	VFEET-3-12	DRK 31" depth racks	3
WANGLE-1	24.00 [610]	30.38 [777]	VFEET-1-12	WRK 27" and 31" depth racks	1
WANGLE-2	48.28 [1226]	30.38 [777]	VFEET-2-12	WRK 27" and 31" depth racks	2
WANGLE-3	72.56 [1843]	30.38 [777]	VFEET-3-12	WRK 27" and 31" depth racks	3
WANGLE-4	96.84 [2460]	30.38 [777]	VFEET-4-12	WRK 27" and 31" depth racks	4
WANGLE-5	121.12 [3076]	30.38 [777]	VFEET-5-12	WRK 27" and 31" depth racks	5
ANGLE-1-42	21.75 [552]	38.75 [984]	VFEET-1-12	MRK 42" depth racks	1
ANGLE-2-42	43.78 [1112]	38.75 [984]	VFEET-2-12	MRK 42" depth racks	2
ANGLE-3-42	65.81 [1672]	38.75 [984]	VFEET-3-12	MRK 42" depth racks	3
DANGLE-1-3642	29.75 [756]	38.75 [984]	VFEET-1-12	DRK 36" and 42" depth racks	1
DANGLE-2-3642	59.78 [1518]	38.75 [984]	VFEET-2-12	DRK 36" and 42" depth racks	2
DANGLE-3-3642	89.91 [2284]	38.75 [984]	VFEET-3-12	DRK 36" and 42" depth racks	3
WMANGLE-1-3642	23.69 [602]	38.75 [984]	VFEET-1-12	WMRK 36" and 42" depth racks	1
WMANGLE-2-3642	47.65 [1210]	38.75 [984]	VFEET-2-12	WMRK 36" and 42" depth racks	2
WMANGLE-3-3642	71.62 [1819]	38.75 [984]	VFEET-3-12	WMRK 36" and 42" depth racks	3
WMANGLE-1-48	23.69 [602]	44.75 [984]	VFEET-1-12	WMRK 48" depth racks	1
WMANGLE-2-48	47.65 [1210]	44.75 [984]	VFEET-2-12	WMRK 48" depth racks	2
WMANGLE-3-48	71.62 [1819]	44.75 [984]	VFEET-3-12	WMRK 48" depth racks	3
BANGLE-1	22.75 [578]	30 [762]	VFEET-1-12	BGR 27" and 32" depth racks	1
BANGLE-1-38	22.75 [578]	41 [1041]	VFEET-1-12	BGR 38" depth racks	1
BANGLE-2	45.78 [1163]	30 [762]	VFEET-2-12	BGR 27" and 32" depth racks	2
BANGLE-2-38	45.78 [1163]	41 [1041]	VFEET-2-12	BGR 38" depth racks	2
BANGLE-3	68.81 [1748]	30 [762]	VFEET-3-12	BGR 27" and 32" depth racks	3
BANGLE-3-38	68.81 [1748]	41 [1041]	VFEET-3-12	BGR 38" depth racks	3
BANGLE-4	91.84 [2333]	30 [762]	VFEET-4-12	BGR 27" and 32" depth racks	4
BANGLE-4-38	91.84 [2333]	41 [1041]	VFEET-4-12	BGR 38" depth racks	4
BANGLE-5	114.87 [2918]	30 [762]	VFEET-5-12	BGR 27" and 32" depth racks	5
BANGLE-5-38	114.87 [2918]	41 [1041]	VFEET-5-12	BGR 38" depth racks	5
SANGLE-24-1-3642	23.69 [602]	38.75 [984]	VFEET-1-12	SNE Series 24" wide 36" and 42" depth racks	1
SANGLE24-1-48	23.69 [602]	44.75 [1137]	VFEET-1-12	SNE Series 24" wide 48" depth racks	1
SANGLE27-1-3642	27.19 [691]	38.75 [984]	VFEET-1-12	SNE Series 27" wide 36" and 42" depth racks	1
SANGLE27-1-48	27.19 [691]	44.75 [1137]	VFEET-1-12	SNE Series 27" wide 48" depth racks	1
SANGLE30-1-3642	29.75 [756]	38.75 [984]	VFEET-1-12	SNE Series 30" wide 36" and 42" depth racks	1
SANGLE30-1-48	29.75 [756]	44.75 [1137]	VFEET-1-12	SNE Series 30" wide 48" depth racks	1
SANGLE24-2-3642	47.65 [1210]	38.75 [984]	VFEET-2-12	SNE Series 24" wide 36" and 42" depth racks	2
SANGLE24-2-48	47.65 [1210]	44.75 [1137]	VFEET-2-12	SNE Series 24" wide 48" depth racks	2
SANGLE27-2-3642	54.85 [1393]	38.75 [984]	VFEET-2-12	SNE Series 27" wide 36" and 42" depth racks	2
SANGLE27-2-48	54.85 [1393]	44.75 [1137]	VFEET-2-12	SNE Series 27" wide 48" depth racks	2
SANGLE30-2-3642	59.65 [1515]	38.75 [984]	VFEET-2-12	SNE Series 30" wide 36" and 42" depth racks	2
SANGLE30-2-48	59.65 [1515]	44.75 [1137]	VFEET-2-12	SNE Series 30" wide 48" depth racks	2
SANGLE24-3-3642	71.71 [1821]	38.75 [984]	VFEET-3-12	SNE Series 24" wide 36" and 42" depth racks	3
SANGLE24-3-48	71.71 [1821]	44.75 [1137]	VFEET-3-12	SNE Series 24" wide 48" depth racks	3
SANGLE27-3-3642	82.51 [2096]	38.75 [984]	VFEET-3-12	SNE Series 27" wide 36" and 42" depth racks	3
SANGLE27-3-48	82.51 [2096]	44.75 [1137]	VFEET-3-12	SNE Series 27" wide 48" depth racks	3
SANGLE30-3-3642	89.71 [2279]	38.75 [984]	VFEET-3-12	SNE Series 30" wide 36" and 42" depth racks	3
SANGLE30-3-48	89.71 [2279]	44.75 [1137]	VFEET-3-12	SNE Series 30" wide 48" depth racks	3

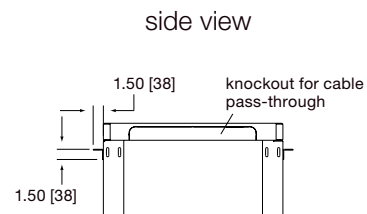
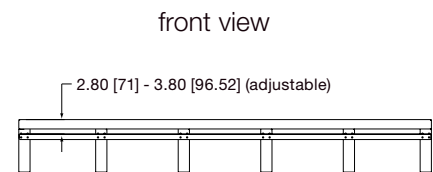
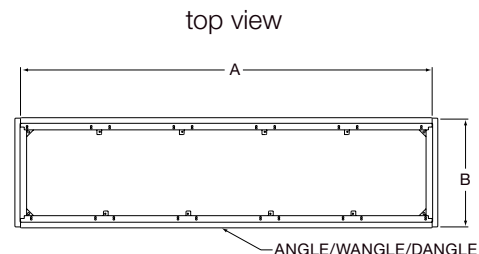

# Riser Bases for SNE Series

## basic dimensions

all dimensions in inches unless otherwise noted [all dimensions in brackets are in millimeters]

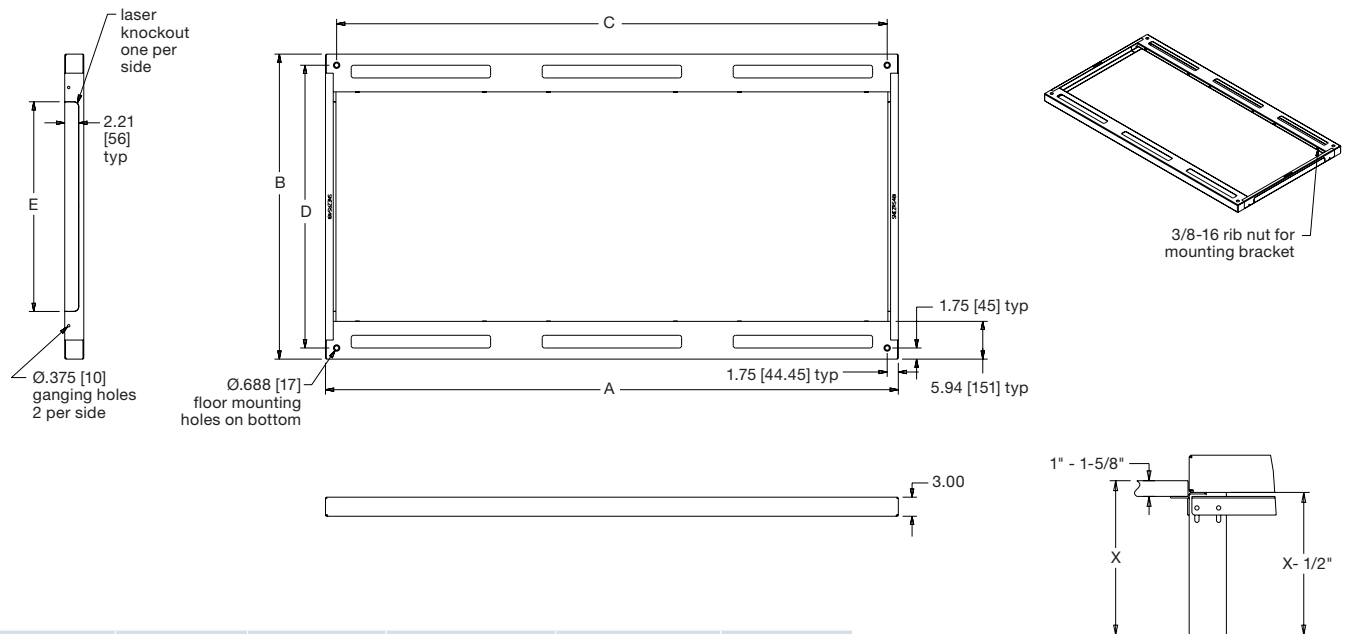

Part Number	A	B	C	D	E
RIB-1-SNE24-36	23.94 [608]	36.00 [914]	20.44 [519.2]	32.5 [825.5]	21.00 [533]
RIB-1-SNE24-42	23.94 [608]	42.00 [1067]	20.44 [519.2]	38.5 [977.9]	27.00 [686]
RIB-1-SNE24-48	23.94 [608]	48.00 [1219]	20.44 [519.2]	44.5 [1130.3]	33.00 [838]
RIB-1-SNE27-36	27.63 [702]	36.00 [914]	24.13 [587.5]	32.5 [825.5]	21.00 [533]
RIB-1-SNE27-42	27.63 [702]	42.00 [1067]	24.13 [587.5]	38.5 [977.9]	27.00 [686]
RIB-1-SNE27-48	27.63 [702]	48.00 [1219]	24.13 [587.5]	44.5 [1130.3]	33.00 [838]
RIB-1-SNE30-36	30.03 [763]	36.00 [914]	26.53 [673.9]	32.5 [825.5]	21.00 [533]
RIB-1-SNE30-42	30.03 [763]	42.00 [1067]	26.53 [673.9]	38.5 [977.9]	27.00 [686]
RIB-1-SNE30-48	30.03 [763]	48.00 [1219]	26.53 [673.9]	44.5 [1130.3]	33.00 [838]
RIB-2-SNE24-36	48.09 [1221]	36.00 [914]	44.59 [1132.6]	32.5 [825.5]	21.00 [533]
RIB-2-SNE24-42	48.09 [1221]	42.00 [1067]	44.59 [1132.6]	38.5 [977.9]	27.00 [686]
RIB-2-SNE24-48	48.09 [1221]	48.00 [1219]	44.59 [1132.6]	44.5 [1130.3]	33.00 [838]
RIB-2-SNE27-36	55.29 [1404]	36.00 [914]	51.79 [1315.5]	32.5 [825.5]	21.00 [533]
RIB-2-SNE27-42	55.29 [1404]	42.00 [1067]	51.79 [1315.5]	38.5 [977.9]	27.00 [686]
RIB-2-SNE27-48	55.29 [1404]	48.00 [1219]	51.79 [1315.5]	44.5 [1130.3]	33.00 [838]
RIB-2-SNE30-36	60.09 [1526]	36.00 [914]	56.59 [1437.4]	32.5 [825.5]	21.00 [533]
RIB-2-SNE30-42	60.09 [1526]	42.00 [1067]	56.59 [1437.4]	38.5 [977.9]	27.00 [686]
RIB-2-SNE30-48	60.09 [1526]	48.00 [1219]	56.59 [1437.4]	44.5 [1130.3]	33.00 [838]
RIB-3-SNE24-36	72.15 [1833]	36.00 [914]	68.65 [1743.7]	32.5 [825.5]	21.00 [533]
RIB-3-SNE24-42	72.15 [1833]	42.00 [1067]	68.65 [1743.7]	38.5 [977.9]	27.00 [686]
RIB-3-SNE24-48	72.15 [1833]	48.00 [1219]	68.65 [1743.7]	44.5 [1130.3]	33.00 [838]
RIB-3-SNE27-36	82.95 [2107]	36.00 [914]	79.45 [2018]	32.5 [825.5]	21.00 [533]
RIB-3-SNE27-42	82.95 [2107]	42.00 [1067]	79.45 [2018]	38.5 [977.9]	27.00 [686]
RIB-3-SNE27-48	82.95 [2107]	48.00 [1219]	79.45 [2018]	44.5 [1130.3]	33.00 [838]
RIB-3-SNE30-36	90.15 [2290]	36.00 [914]	86.65 [2201]	32.5 [825.5]	21.00 [533]
RIB-3-SNE30-42	90.15 [2290]	42.00 [1067]	86.65 [2201]	38.5 [977.9]	27.00 [686]
RIB-3-SNE30-48	90.15 [2290]	48.00 [1219]	86.65 [2201]	44.5 [1130.3]	33.00 [838]

Note:  
when a specific floor height is desired ("X"), custom veelet height should be X - 1/2" (for tile between 1" and 1-5/8").