

## I-LUH (Rev. 2/12/25): Instructions for Unihorn™ Models LUH-15TA and LUH-15TX

The Unihorn® is a re-entrant horn engineered for general voice communications systems. While all Unihorn models feature cast aluminum housing suitable for indoor or outdoor applications when mounted exposed (without an accessory backbox), note that some accessories are not suitable for outdoor use.

*Note: Either model may also be mounted to most industry standard 8-inch speaker grilles. That will not void the UL Listing.*

### MODEL SELECTION



**Includes:**

- 15W driver with transformer and tap selector
- Cast aluminum housing with mounting dogs
- Press-fit mesh grille
- Trim ring

**Unihorn Model LUH-15TA** offers the greatest flexibility for 25V, 70V, 100V or 8 ohm applications, as it includes a press-fit mesh grille and trim ring that can be mounted or not, according to the needs of the project. The grille adds a finished look, while protecting the front of horn from nesting birds and insects. The housing features mounting dogs for quick installation.

Location	Application	Accessories (required)	Accessories (optional)
Indoor	• Exposed	• LUH-BRKT (bracket) or custom rigging hardware	• LUH-VRG (grille)
	• Recessed (existing drywall)	-----	• LUH-VRG (grille)
	• Recessed (before drywall is installed)	• LUH-RIB (rough-in bridge)	• LUH-VRG (grille)
	• Recessed (drop tile ceiling)	• LUH-TBAR (tile bridge)	• LUH-VRG (grille)
	• Recessed (masonry)	• LUH-BOX (backbox) & LUH-TP (trim plate)	• LUH-VRG (grille)
Outdoor	• Surface-mount	• LUH-BOX (backbox)	• LUH-VRG (grille)
	• Exposed	• LUH-BRKT (U-bracket) or custom rigging hardware	• LUH-VRG (grille)
	• Recessed (masonry)	• LUH-BOX (backbox) & LUH-TP (trim plate)	• LUH-VRG (grille)
	• Surface-mount	• LUH-BOX (backbox)	• LUH-VRG (grille)

Accessories for use with model LUH-15TA — order separately: (see product spec sheets for information)



**LUH-VRG**  
vandal-resistant grille  
indoor / outdoor



**LUH-BRKT**  
U-bracket  
indoor / outdoor

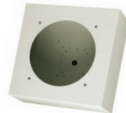

**LUH-BOX**  
recessed / surface box  
indoor / outdoor

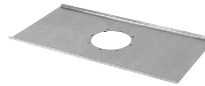

**LUH-TBAR**  
tile bridge  
indoor only



**LUH-TP**  
trim plate  
indoor / outdoor



**LUH-RIB**  
rough-in bridge  
indoor only



**Includes:**

- 15W driver with transformer and tap selector
- Cast aluminum housing (without mounting dogs)

**Unihorn Model LUH-15TX** is an economical choice because it does not include the press-fit grille or trim ring, and the housing does not feature mounting dogs. It's made specifically for two types of (25V, 70V, 100V) applications:

- 1). Installations that plan to mount the horn exposed using the optional U-bracket (order separately).
- 2). Installations that plan to use an existing, industry standard 8-inch grille.

Location	Application	Accessories (required)	Accessories (optional)
Indoor / Outdoor	• Exposed	• LUH-BRKT (U-bracket) or custom rigging hardware	• LUH-VRG (grille)

Accessories for use with model LUH-15TX — order separately: (see product spec sheets for information)



**LUH-VRG**  
vandal-resistant grille  
indoor / outdoor



**LUH-BRKT**  
U-bracket  
indoor / outdoor

## INSTALLATION

**WARNING!** Speaker installation should only be performed by qualified professionals with experience and knowledge of load-rated hardware, and safe installation mounting and rigging techniques. Improperly installed equipment can result in property damage, personal injury or death, and/or liability to the installing contractor. The speaker system must be mounted in accordance with all local, state, and federal codes and regulations, and the installation must conform to industry standard practices. It is the responsibility of the installer to properly select all hardware for rigging and installation, safety and restraint cables, and to consult a licensed mechanical or structural engineer to evaluate and certify the structural integrity and safety of any mounting method and its suitability for the building structure. Lowell Manufacturing Company, its affiliates, employees, and/or independent sales representatives, are not responsible for the use, misuse, misapplication, or unsafe installation of any horn or speaker system.

**NOTE:** To determine speaker spacing, see the technical paper "Distributed System Speaker Spacing for the Integrator" at [LowellMfg.com](http://LowellMfg.com). An online spacing calculator is also available.



Exposed (with U-bracket)

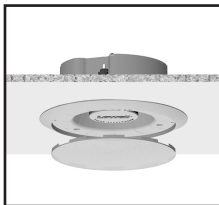

Recessed in drywall

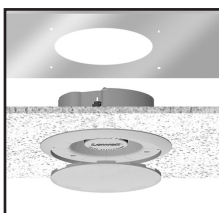

Recessed in drop tile ceiling (with t-bridge)

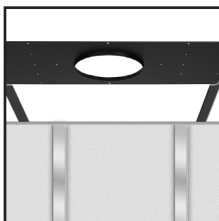

Recessed before installing drywall (with rough-in bridge)

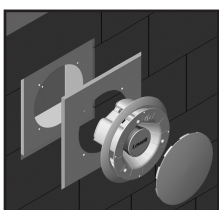

Recessed in masonry (with backbox & trim plate)



Surface-mount (with backbox)

### Model LUH-15TA

#### EXPOSED:

- **Open Architecture (with installer-furnished hardware):** Use the two threaded 1/4–20 mounting posts (on back of horn) to mount the horn with 1/4-20 threaded rods or bolts, or custom rigging hardware. Tighten the three dog ears to clamp the horn to the trim ring. Press the mesh grille into the ring to fit securely in place.
- **Ceiling or Wall (with LUH-BRKT bracket):** Mount the bracket to the surface. Then place the back of the horn through the trim ring and use the two threaded 1/4–20 mounting posts (on back of horn) to mount the horn to the bracket. Tighten the three dog ears to clamp the horn to the trim ring. Press the mesh grille into the ring to fit securely in place.

**RECESSED:** Before mounting the horn in recessed applications, be sure to check for obstructions behind the ceiling or wall. For more information, see the technical paper online at [https://www.lowellmfg.com/wp-content/uploads/Checking\\_above\\_the\\_ceiling\\_before\\_you\\_cut.pdf](https://www.lowellmfg.com/wp-content/uploads/Checking_above_the_ceiling_before_you_cut.pdf)

- **Existing Drywall:** Use the inside of the trim ring to trace a 7.25" diameter mounting hole in the ceiling (or wall). Cut the hole. Place the back of the horn through the trim ring and into the mounting hole, aligning tapped holes on the ring with those in the lip of the horn. Holding the horn flush against the ceiling (or wall), tighten the three mounting dogs to clamp the horn to the ring. Press the mesh grille into the ring to fit securely in place.
- **Drop Tile Ceiling (with LUH-TBAR tile bridge):** The tile-bridge distributes the weight of the speaker to the ceiling grid, which will help prevent sagging. Begin by removing the ceiling tile and placing the bridge on the back of the tile to mark where the mounting hole should be cut. Cut the 7.25" mounting hole, then replace the tile in the ceiling grid with the bridge sitting on top of it. Place the back of the horn through the trim ring and into the mounting hole. Holding the horn flush against ceiling tile, tighten the three dog ears on the back of the horn to clamp it to the trim ring, tile and bridge. Press the mesh grille into the ring to fit securely in place.

#### New Construction

- **Before Drywall is installed (with LUH-RIB rough-in bridge):** Reserve space for the horn by mounting a rough-in bridge to the framing, positioning the bridge so the return lip protrudes into the room. The drywall installer uses the lip as a guide to trace the mounting hole. Be sure to install wiring so it can be accessed when drywall is in place. After drywall is installed and painted, mount the horn by placing the back of it through the trim ring and into the mounting hole. Holding the horn flush to the ceiling (or wall), tighten the horn's three dog ears to clamp it to the bridge and trim ring. Then press the mesh grille into the ring so it fits securely in place.
- **Exterior Masonry (with LUH-BOX backbox and LUH-TP trim plate):** Run speaker wire into the backbox, then mount the box in the wall using mortar to hold it in place. After the mortar dries, mount the trim plate to the front of the backbox using four 8-32 screws (provided). The trim plate is larger than the backbox so it will cover rough mortar edges. Place the back of horn through the trim ring and into the box. Tighten the three dog ears to clamp the horn to the backbox and ring. Press the mesh grille into the ring to fit securely in place.
- **Interior Masonry (with LUH-BOX backbox):** Run speaker wire into the backbox, then mount the box in the wall using mortar to hold it in place. After the mortar dries, mount the trim plate to the front of the backbox using four 8-32 screws (provided). The trim plate is larger than the backbox so it will cover rough mortar edges. Place the back of horn through the trim ring and into the box. Tighten the three dog ears to clamp the horn to the backbox and ring. Press the mesh grille into the ring to fit securely in place.

#### SURFACE-MOUNT:

- **Exterior Surface (with LUH-BOX backbox):** Run speaker wire into backbox, then mount backbox to surface. Place back of horn through trim ring and into backbox. Tighten three dog ears to clamp horn to backbox and trim ring. Press the fine mesh grille into the trim ring so it fits securely in place.
- **Interior Surface (with LUH-BOX backbox):** Run speaker wire into backbox, then mount backbox to surface. Place back of horn through trim ring and into backbox. Tighten three dog ears to clamp horn to backbox and trim ring. Press the fine mesh grille into the trim ring so it fits securely in place.

## Model LUH-15TX

### EXPOSED

- **Open Architecture (with installer-furnished hardware):** Use the two threaded 1/4–20 mounting posts on back of horn to mount horn using 1/4-20 threaded rods or bolts, or custom rigging hardware.
- **Ceiling or Wall (with LUH-BRKT bracket):** Mount bracket to surface. Use the two threaded 1/4–20 mounting posts on back of horn to mount the horn to bracket.

### WIRING & SCHEMATICS

**Model LUH-15TA & LUH-15TX:** Horn ships with pigtail exiting a waterproof connector. The red wire is the positive (+) conductor and the black wire is the negative (-) conductor. The pigtail has been factory-connected to the 25V/70V/100V input terminals inside of the termination compartment. A splice can be made to the pigtail, using UL-approved splice connectors, if the splice is made inside a UL recognized junction box (ex. Lowell LUH-BOX). If a UL-approved junction box is not used, the waterproof fitting should be loosened, the pigtail should be disconnected and removed, the field wiring should be fed through the waterproof connector, and the termination should be made directly to the input terminals in the termination compartment. The waterproof fitting should then be tightened. Note that to maintain a UL-required seal at the waterproof fitting, the field wiring used must have a round jacket with a diameter of 0.197" to 0.256".

**For 8-ohm connection,** remove the jumper on the upper 8-ohm terminal strip, and terminate the input wiring on the positive (+) and negative (-) 8-ohm terminals. This bypasses the transformer and selector switch as shown on the schematic below.

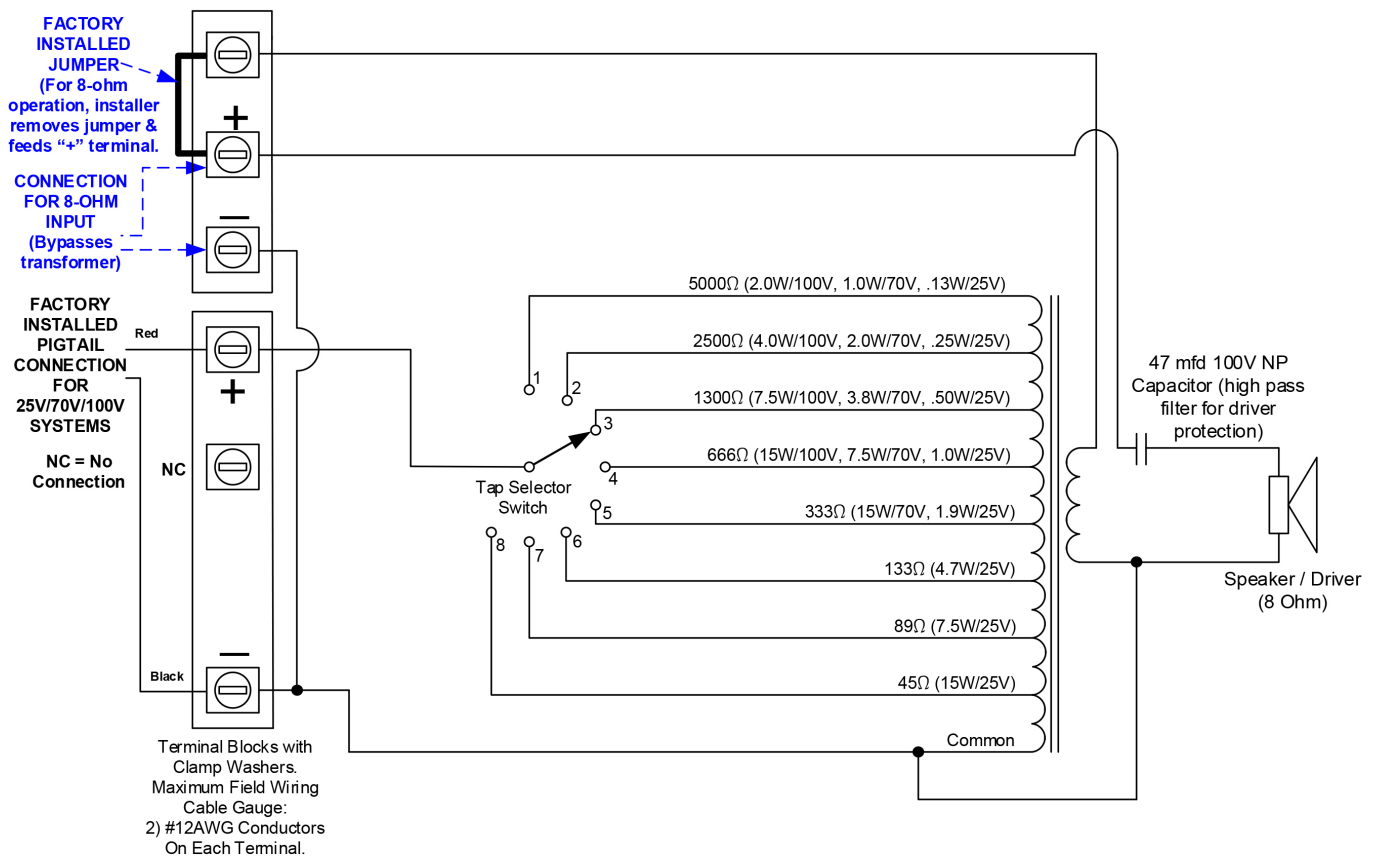

## HORN SPECIFICATIONS

Model No.	LUH-15TA and LUH-15TX
Power Rating (per EIA standard RS 426-B)	15W RMS
Frequency Response	740Hz-704kHz ± 6dB
Sensitivity (using 70V inputs)	105dB 1W/1M
Calculated Max. SPL (based on power rating & measured sensitivity)	116.8dB 15W/1M
Conical Dispersion	80 degrees @ 2kHz octave
Input Impedance (nominal)	5000, 2500, 1300, 666, 333, 133, 89, 45 ohms
Transformer Power Taps	25V@ .13W, .25W, .50W, 1.0W, 1.9W, 4.7W, 7.5W, 15W 70V@ 1.0W, 2.0W, 3.8W, 7.5W, 15W 100V@ 2.0W, 4.0W, 7.5W, 15W
Voltage Input	25V, 70V, or 100V selectable taps

\*Measured in Lowell audio lab.

\*\*UL measured A weighted reverberant room sound power output.

\*\*\*3dB increment rating with a sweep sine-wave signal source flat weight SPL meter.

## PHYSICAL ATTRIBUTES

### Outside Dimensions

Horn housing..... 7.1 in. (180 mm) dia. housing with 8.0 in. (203 mm) dia. face x 3.72 in. (94 mm) depth

Horn, trim ring, grille..... 7.1 in. (180 mm) dia. housing with 9.6 in. (244 mm) dia. trim ring/grille x 3.30 in. (84 mm) depth x 0.772 in. (19 mm) proj.

Material ..... Cast aluminum housing with gasketed rear cover; cast aluminum trim ring; perforated aluminum grille

Mounting Bolt Circle ..... 7.625 in. (194 mm) with 4 holes spaced to mount an E.I.A. 8 in. speaker grille

Cutout Diameter ..... 7.25 in. (184 mm)

Weight ..... Model LUH-15TA = 4.9 lbs. (2.22 kg)

..... Model LUH-15TX = 4.1 lbs. (1.86 kg)

## SELECTOR SWITCH VALUES

Switch Position	Nominal Impedance	Watts @25V	Watts @70V	Watts @100V
1	5000	.13	1.0	2.0
2	2500	.25	2.0	4.0
3	1300	.50	3.8	7.5
4	666	1.0	7.5	15
5	333	1.9	15	X
6	133	4.7	X	X
7	89	7.5	X	X
8	45	15	X	X

X =DO NOT USE. Switch positions 6, 7, 8 (for 70V applications) and 5, 6, 7, 8 (for 100V applications) will exceed the power handing capacity of the driver and transformer and could destroy the driver, transformer and/or amplifier.



Listed for UL1480A, CSA C22.2 No. 205-12 General Signaling for outdoor wet use. UL2043 for use in return air plenum space.