

Entry Trim Ordering Matrix

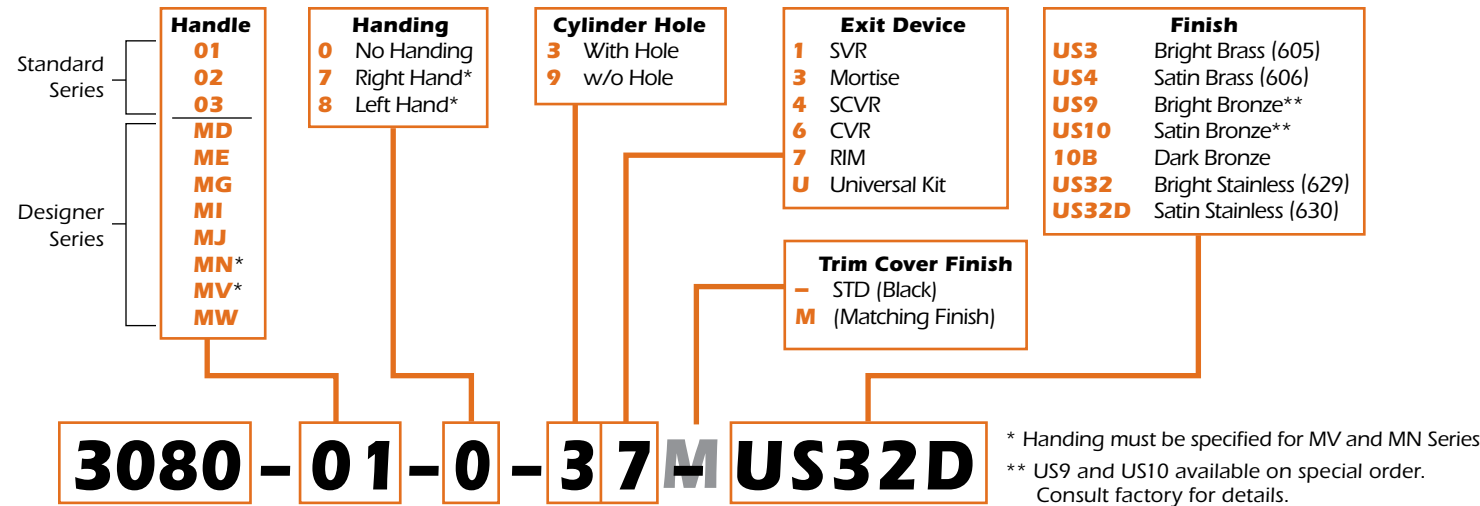

Fixed Pull Ordering Matrix

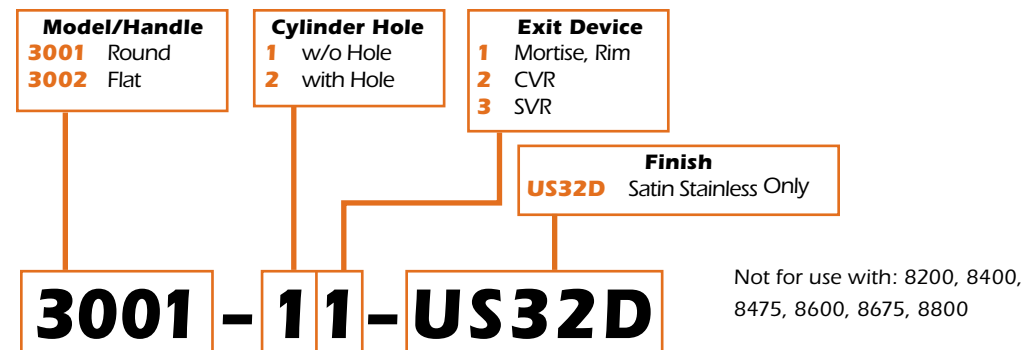

Thumbturn Ordering Matrix

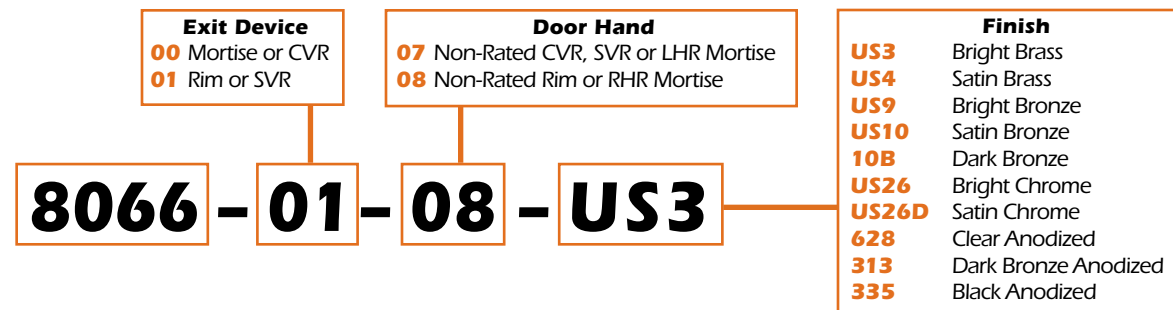

Entry Trim

For all Adams Rite Exit Devices

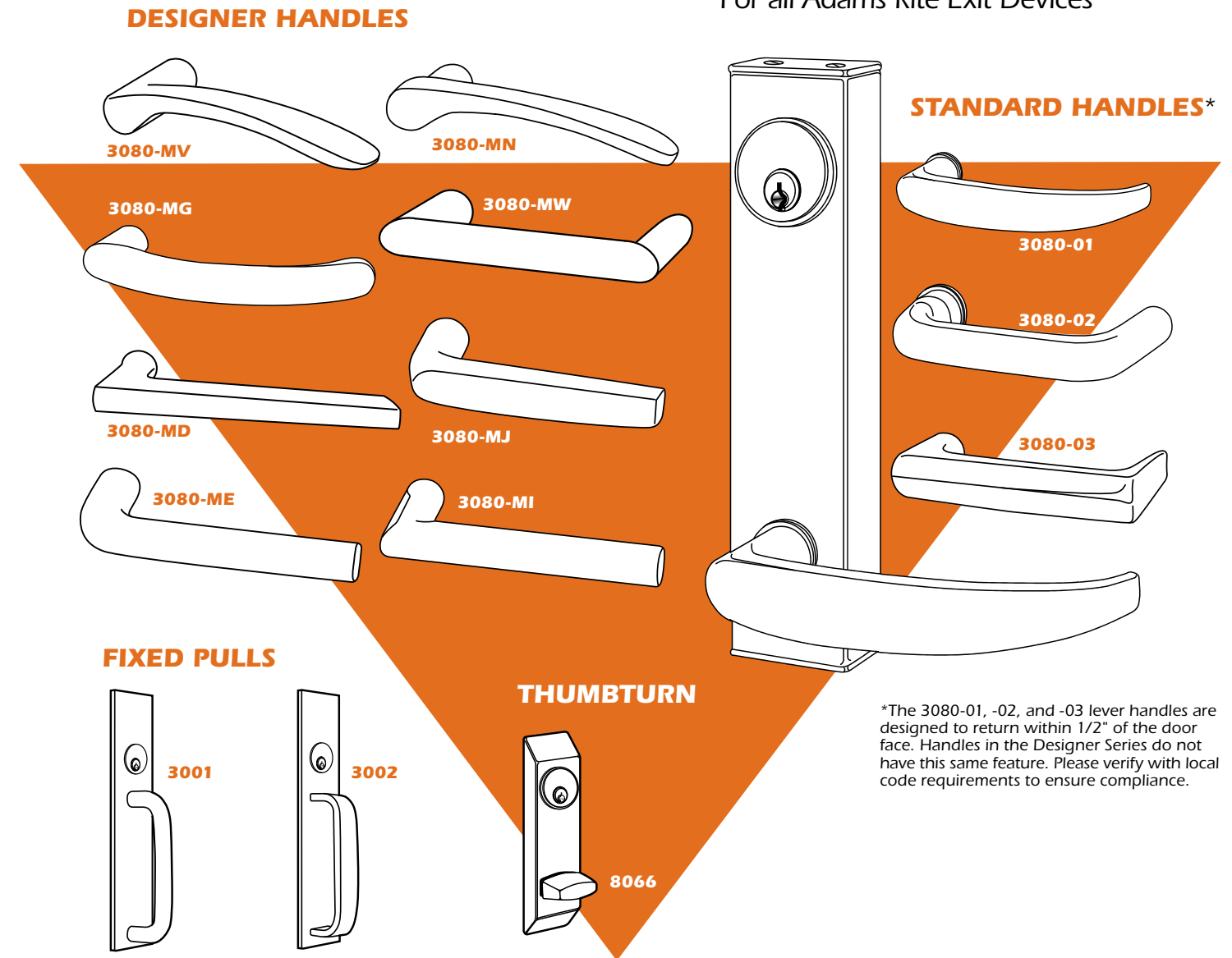

3080 Series Entry Trim

The 3080 Series provides outside activation of doors that have any type of Adams Rite Exit Device. Breakaway clutching mechanism protects the locked handle from vandalism or forced entry, in either direction. All models share the same core components, so handles can be changed without having to replace the entire trim. Solid construction meets Grade 1 standards.

3001 & 3002 Fixed Pulls

US32D Satin Stainless Steel pulls have 2-3/4" x 11-1/2" escutcheon. Order with or without cylinder hole. For hollow metal and wood doors only.

8066 Thumbturn

Thumbturn and any standard mortise cylinder with MS cam allow entry control in two modes: latched, but openable by thumbturn, or latched with entry by key only with 8067 Nightlatch Kit.



Entry Trim

INSTALLATION

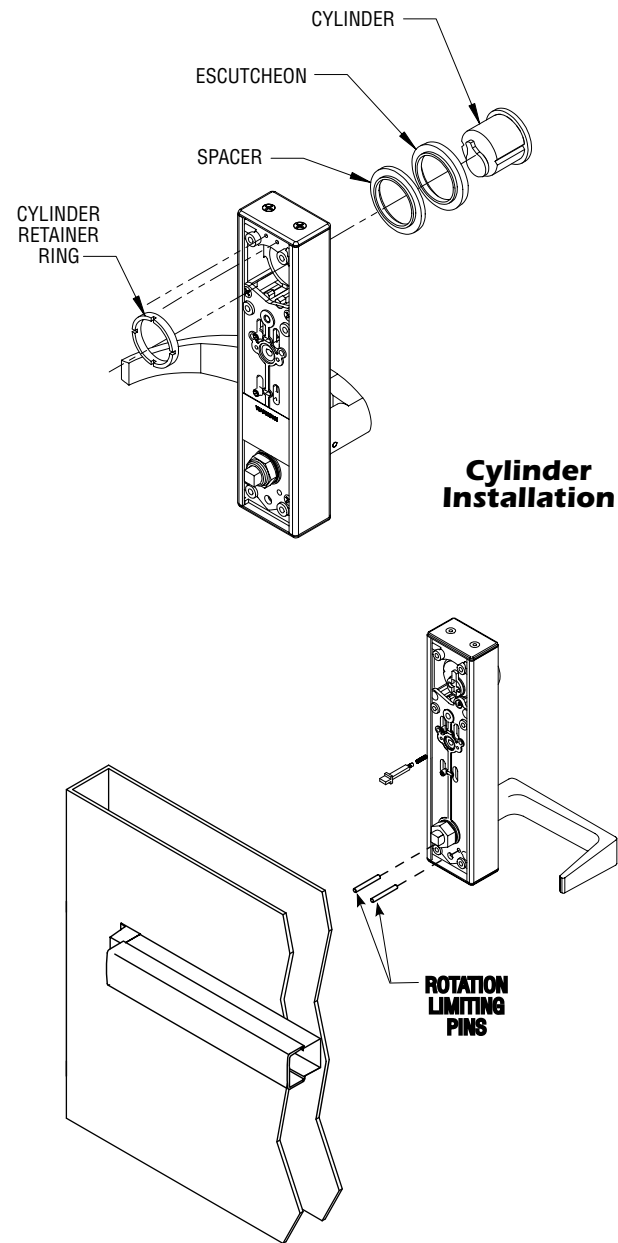

Door Preparation and Trim Installation

Door prep and installation will differ depending on type of exit device being used. Refer to Adams Rite Templates for 3080 Series Entry Trim preparation details.

CYLINDERS

Mortise Cylinder

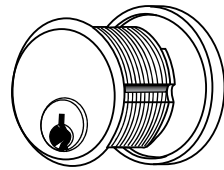

4036-01

Standard diameter five-pin unit with MS® cam, suitable for use with entry trim. All brass construction with front "scalp" available in finishes 628, 313 and 335. Available in quantity all keyed different (KD), in pairs (KA2) or fifty alike (KA50). Any other make standard mortise cylinder with MS® cam can be used to "key in" with existing systems.

Cylinder Cam

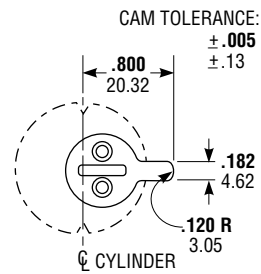

3080 Series Entry Trim can accept any standard 1-5/32" diameter mortise cylinder with special MS® cam dimensioned as shown. Cylinders with MS® cams can be readily obtained from most cylinder manufacturers. See page SW-36 for cylinder make and trim ring information.

OPTIONS

Can be ordered with or without a hole for cylinder. Order standard mortise cylinder with MS® cam separately.

Entry Trim

DIMENSIONS

INCHES
MILLIMETERS

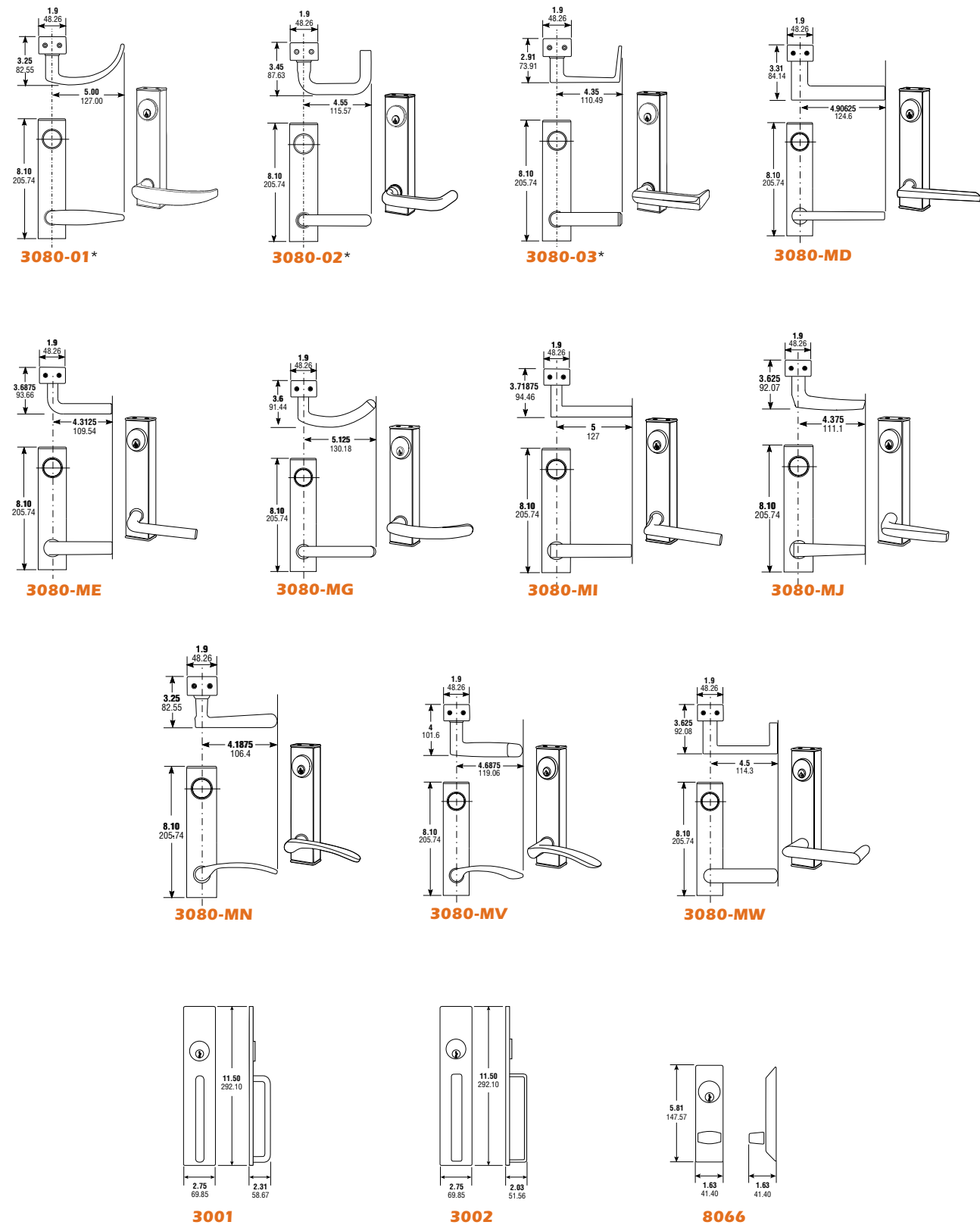

*The 3080-01, -02, and -03 lever handles are designed to return within 1/2" of the door face. Handles in the Designer Series do not have this same feature. Please verify with local code requirements to ensure compliance.