

8200 Series (Life-Safety) Narrow Stile Surface Vertical Rod Exit Device

ELECTRIFIED
OPTION

ALUMINUM



GRADE 1

Features

- Patented top latching mechanism interlocks door to frame
- Strong, durable construction for a high level of security
- Adjustable steel rods protected in contoured covers
- Easy to install
- Clean, unobtrusive design
- Pushbar clad or anodized, not plated, in a variety of finishes

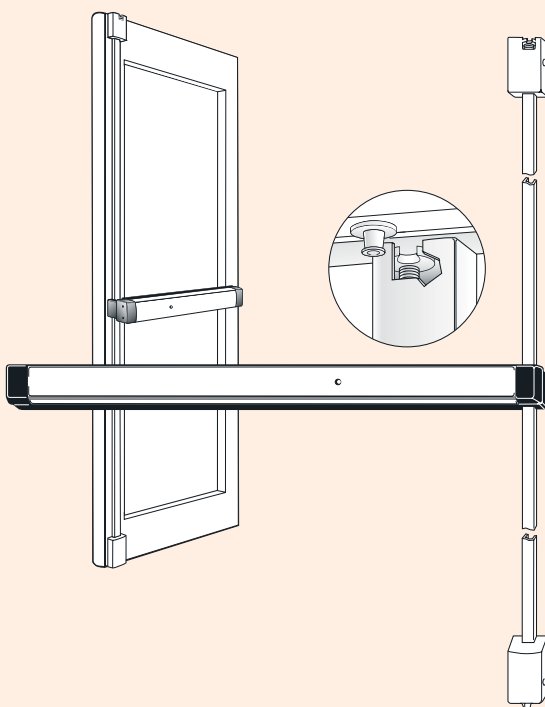

Specifications

8200 SERIES CERTIFICATIONS:

- UL 305 Panic Hardware
- Warnock/Hersey Life-Safety Listing
- ANSI/BHMA A156.3 Grade 1
- California State Fire Marshall
- New York City MEA*

*Consult Factory for specific number

MATERIALS

- Pushbar made of extruded aluminum, clad or anodized in a variety of finishes.

HANDING

- Device is non-handed. Lever Entry Trim is field reversible.

PUSHBAR LENGTH

- Standard sizes: dimensioned for 30", 36", 42", and 48" openings. Standard width bars can be field cut to the next smallest opening width.

BAR HEIGHT

- Standard model adjusts from 30" to 44".

DOOR HEIGHT

- Standard model fits up to 8 ft door, with bar height at 40"- 44". For doors up to 10 ft, use Tall Door Kit 8055.

DOOR THICKNESS

- Suits 1-3/4" standard, up to 2-1/4".

STILE WIDTH

- Minimum 2" stile. Fits narrow, medium, and wide stile aluminum doors.

PROJECTION

- 2-15/16" when fully projected, 1-15/16" when dogged.

DOGGING

- Standard dogging with hex key or cylinder dogging option. Electric dogging also available.

FASTENERS

- Standard self-tapping screws.

CYLINDERS

- See CYLINDERS section of this catalog for cylinder make, thumbturn and trim ring information. (Available separately).

CYLINDER X FIXED PULL (FUNCTION 03)

- Accepts any standard rim cylinder.

3080 ENTRY TRIM (FUNCTIONS 08, 09)

- Accepts any standard diameter mortise cylinder with MS® cam. Accommodates cylinder lengths from 1" to 1-1/4". (Available separately).

WARRANTY

- Five year limited.

Bolts and Strikes

- The patented top latching mechanism utilizes a rotating top bolt which deadlatches around the header strike, interlocking the door to the frame. Supplied with standard header strike. The hexagonal, hardened steel bottom bolt is shielded in a cast housing for strength and stability.

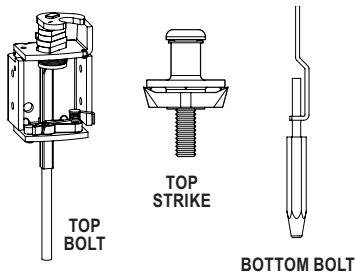

Options and Accessories

SILENT ELECTRIFICATION MOTORIZED LATCH RETRACTION

- The SE Motorized Latch Retraction option provides near-silent operation for quiet environments such as hospitals, offices, hotels, and libraries where solenoid-driven devices would be disruptive.

ELECTRIC LATCH RETRACTION

- The LR option uses a solenoid mounted in the pushbar for instantaneous unlocking and locking of the exit device from a remote location or access control device. LR option is not available on rim type exit devices (see EL option).

ALARMED EXIT DEVICE

- This battery-operated option emits a loud (95 decibel) alarm to notify management of unauthorized exit. Available on minimum opening width 36". Cannot be ordered with other exit device options.

REQUEST TO EXIT (REX) – MONITOR / SIGNAL SWITCH

- Mounted in the exit device pushbar on the hinge end, the switch can be used to activate signal light, horn, monitor, or other devices.

CYLINDER DOGGING

- For management control of dogging exit devices for life-safety exit devices only.

ELECTRIC DOGGING

- A holding magnet keeps the pushbar depressed (set manually) and the latch retracted for lower profile exit devices, resulting in less damage and quieter operation.

MATCHING END CAPS

- Matching end caps are available for applications where it is preferable that the end caps match the finish of the exit device. Available for US Finishes only.

AVAILABLE FINISHES

- 313 Dark Bronze Anodized
- 335 Black Anodized
- 628 Clear Anodized
- US3 Bright Brass
- US4 Satin Brass
- US32 Bright Stainless
- US32D Satin Stainless

For more detailed information on any of the options and accessories listed above please see the Accessories page of the EXIT DEVICE section of this catalog.

HOW TO ORDER 8200 SERIES (LIFE-SAFETY) NARROW STILE SURFACE VERTICAL ROD EXIT DEVICE

Specify quantity and the following information. Order related products separately.

MODEL	PUSHBAR FINISH	ROD TYPE	DEVICE OPTIONS	MONITORING OPTION	DOOR OPENING WIDTH On pair of doors, specify HALF of the total exit opening	US FINISH	END CAPS OPTION
82	00	-	ED	M2	-36	-US3	
82 Life-Safety	00 US Finish	T Top Rod only	LR Electric Latch Retraction	M Single Switch	30 30 inches	US3 Bright Brass	MEC Matching End Caps
	11 Clear Anodized 628	- Standard rod	SE Silent Electrification Latch Retraction	M2 Dual Switch	36 36 inches	US4 Satin Brass	
	22 Dark Bronze Anodized 313		C Cylinder Dogging	(Blank) No Option	40 40 inches	US32 Bright Stainless	
	33 Black Anodized 335		ED Electric Dogging		48 48 inches	US32D Satin Stainless	
			(Blank) No Option		AXXB Alarmed Exit Device where XX is door opening width		

NOTE that Alarmed Exit Device option cannot be combined with Device Options or Monitoring Options.

ALSO NOTE: Split finishes (faceplate/pushbar) are not available.

RELATED ANSI TRIM FUNCTIONS

01	02	03	08	09	14
Exit only – no outside operation	No outside operation – pull only when dogged	Night latch – key retracts latch	Key outside unlocks/locks lever	Night latch - key unlocks trim, trim retracts latch/trim relocks when key is removed	Passage only
Cylinder Type					
N/A	N/A	Rim	Mortise	Mortise	N/A

Please see TRIM Section of this catalog for information on Pulls and Entry Trim.

RELATED PRODUCTS When purchasing this product, please consider the following related products, available separately:

Accessories	Cylinders	Trim	Power
REX-Monitor/Signal Kits. Tall Door Kit 8055.	Adams Rite exit devices are operable by either rim or mortise cylinders depending upon the ANSI/BHMA functions of the exit device.	Entry trim and fixed pulls.	PS-SE, PS-LR, and 4612 Power Transfer Device.