

LC LED Up Light **DESIGNER PREMIUM**



PROJECT

CATALOG #

TYPE

NOTES

High-performance wall wash light in 3, 6, or 9 LED. Available in aluminum or brass construction. RGBW capable with Luxor® systems.

Quick Facts

- Die-cast aluminum
- Two-layer marine-grade anodization and powder coat finish
- Lumileds® integrated LEDs
- ProAim™ adjustability
- Tamper-resistant features
- Compatible with Luxor technology
- Phase dimmable
- Input voltage: 10-15V

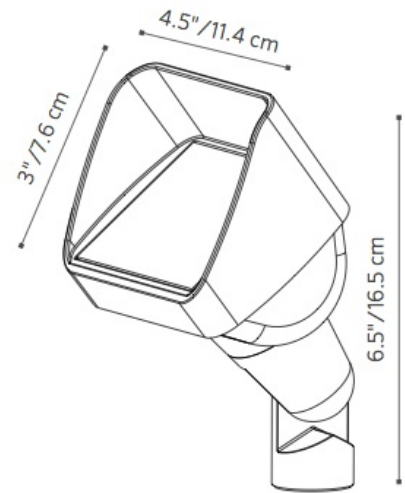

LC LED Up Light SPECIFICATIONS

Output	3LED	6LED	9LED	ZDC
Total Lumens †	305	540	811	192
Input Voltage	10 to 15V	10 to 15V	10 to 15V	11 to 15V
Input Power (Watt)	4.0	7.7	11.1	9.1
Power Consumption (VA)	4.4	9.3	12.2	11.0
Efficacy (Lumens/Watt)	77	70.0	73.0	37.0
Color Rendering Index (CRI)	84	84	84	80+
Center Beam Candlepower*				
Very Wide Flood (90)	147	262	400	193
Dimming				
Primary Dimming (Transformer)	Consult transformer specifications			
Secondary Dimming (Fixture)	Phase-cut**	Phase-cut**	Phase-cut**	Luxor
RGBW Available	No	No	No	Yes
Luxor Compatibility				
Default	Zoning	Zoning	Zoning	--
ZD Option	Zoning/Dimming	Zoning/Dimming	Zoning/Dimming	--
ZDC Option	--	--	--	Zoning/Dimming/Color
Minimum Rated Life (L70)	72,000 Hrs	72,000 Hrs	72,000 Hrs	55,000 Hrs

* Information not available for Flood or Wide Flood.

** For optimal performance, use a trailing-edge, phase-cut dimmer.

† Measured using the 2,700K CCT option.

About FX Luminaire

As a leading manufacturer of landscape and architectural lighting, FX Luminaire provides innovative products, resources, and support to help customers bring their visions to life. The company offers a range of specification-driven solutions, including fixtures, controls, and accessories, to enhance residential and commercial landscapes.

Materials

Die-cast C360 brass housing, shroud, and knuckle/base assembly with brass hardware or die-cast aluminum A380 housing, shroud, and knuckle with stainless steel hardware.

Knuckle

Die-cast brass or die-cast aluminum knuckle with ½"-14 NPSM threads. Compress and lock features prevent slip after installation. 9° increments adjustability over 220° of vertical adjustment.

LED

Integrated module with Lumileds LEDs. Gold-plated connectors and conformal coated for maximum reliability and corrosion resistance. Proprietary on-board intelligent driver uses firmware-controlled temperature regulation, maximizing LED life. Field upgradeable and replaceable, the LEDs are rated to 72,000 hrs. Maximum drive current: 1 A.

Optics

Color temperature defined by part number. Beam angle is calculated using LM-79 method for SSL luminaires.

Finish

Options of powder coat, natural brass finish, or antiqued finish with brushed (Antique Bronze) or tumbled (Antique Tumbled) effect. Powder coat finishes sealed with two-layer protection of sulfuric acid anodization and polyester TGIC powder coat, providing superior outdoor weathering in all conditions. Tested to ASTM standards. Antique finishes sealed with a clear TGIC powder coat layer.

Hardware

Brass or stainless steel angle lock screw. Includes 12" (305 mm) ABS slotted installation spike.

Wiring

18 AWG (1 mm); SPT-1W; 220°F (105°C); 300V; 10' (3 m) length.

Sockets

Socket contains MoistureBlock™ technology, preventing moisture from wicking up into sealed areas of the fixture.

Power

Input 10-15VAC/VDC 50/60Hz. Remote transformer required (specify separately).

Housing

Die-cast brass or aluminum housing with capacity for 1LED, 3LED, 6LED, 9LED, or ZDC integrated LEDs.

Glare Control

Die-cast brass or aluminum shroud with 30° cutoff.

Weight

3.8 lbs. (1.7 kg)

Lens

Tempered frosted glass lens with shock resistance and high tolerance for thermal expansion and stress.

International Compliance

Compliant per IEC 60598-1 and IEC 60598-2-4 when used with International Spike Kit ("EKITSPIKE") or alternate mount greater than or equal to IP65, or by selecting the "e" version.

Ambient Operating Temperature

0°F to 140°F (-18°C to 60°C)

Sustainability

Innovation meets conservation in the design and manufacturing of our products. Where we can, we use recycled materials while maintaining superior functionality. Our LED products provide high quality light at optimal energy efficiency, lifespan, and durability.

Installation Requirements

Designed for installation in the upward direction only.

Control

ZD or ZDC options utilize Luxor technology to zone light fixtures in up to 250 groups, dim each group in 1% increments between 0 and 100%, or change to one of 30,000 colors with RGBW LEDs. Select the ZD option for zoning/dimming or ZDC for zoning/dimming/color. Standard fixture is zoneable with Luxor.

Manufacturing

ISO 9001:2015 certified facility

Warranty

10-year limited warranty.

Listings



LC LED Up Light ORDERING INFORMATION

[field_spec_builder_mount] [field_spec_builder_mount]

Fixture Control	Power	Color Temp	Compliance	Finish
LC [Default] Zone with Luxor, On/Off, Phase Dimmable	3 LED 4.0W/4.4VA	[Default] Warm (2700K)	[default] North America (UL Listed)	BZ Bronze Metallic
ZD Zone/Dim with Luxor	6 LED 7.7W/9.3VA	S Soft (3000K)	E International (CE Certified)	FB Black
ZDC Zone/Dim/Color with Luxor	9 LED 11.1W/12.2VA	C Cool (4000K)		DG Desert Granite
	[default ZDC option] 9.1W/11.0VA	[Default] RGBW, ZDC Option Required		WI Weathered Iron
				SB Sedona Brown
				FW Flat White
				SV Silver
				AB Antique Bronze
				AT Antique Tumbled
				NP Nickel Plate
				BS Natural Brass



EXAMPLE FIXTURE CONFIGURATION: LC-XX-XXXX-XX

LC 3LED - Illuminance at a Distance

Distance	Center Beam fc	Beam Width	
Feet (Meters)	Foot-Candles (Lux)	Vertical : 95.4 °	Horizontal : 84.5 °
4' (1.2 m)	4.9 fc (53 lx)	8.8' (2.7 m)	7.3' (2.2 m)
8' (2.4 m)	1.2 fc (13 lx)	17.6' (5.4 m)	14.5' (4.4 m)
12' (3.7 m)	0.6 fc (7 lx)	26.4' (8.1 m)	21.8' (6.7 m)
16' (4.9 m)	0.3 fc (3.2 lx)	32.2' (9.8 m)	29.0' (8.8 m)
20' (6.1m)	0.2 fc (2.2 lx)	44.0' (13.4 m)	36.3' (11.1 m)
24' (7.3 m)	0.1 fc (1.1 lx)	52.8' (16.1 m)	43.6' (13.3 m)

LC 6LED - Illuminance at a Distance

Distance	Center Beam fc	Beam Width	
Feet (Meters)	Foot-Candles (Lux)	Vertical : 94 °	Horizontal : 81.5 °
4' (1.2 m)	10.7 fc (115 lx)	8.6' (2.6 m)	6.9' (2.1 m)
8' (2.4 m)	2.7 fc (29 lx)	17.2' (5.2 m)	13.8' (4.2 m)
12' (3.7 m)	1.2 fc (13 lx)	25.7' (7.8 m)	20.7' (6.3 m)
16' (4.9 m)	0.7 fc (8 lx)	34.3' (10.5 m)	27.7' (8.4 m)
20' (6.1m)	0.4 fc (4.3 lx)	42.9' (13.1 m)	34.6' (10.6 m)
24' (7.3 m)	0.3 fc (3.2 lx)	51.5' (15.7 m)	41.5' (12.7 m)



















LC 9LED - Illuminance at a Distance

Distance	Center Beam fc	Beam Width	
Feet (Meters)	Foot-Candles (Lux)	Vertical : 90 °	Horizontal : 81.7 °
4' (1.2 m)	14.4 fc (155 lx)	8.1' (2.5 m)	6.9' (2.1 m)
8' (2.4 m)	3.6 fc (39 lx)	16.3' (5.0 m)	13.8' (4.2 m)
12' (3.7 m)	1.6 fc (17 lx)	24.4' (7.4 m)	20.7' (6.3 m)
16' (4.9 m)	0.9 fc (10 lx)	32.5' (9.9 m)	27.7' (8.4 m)
20' (6.1m)	0.6 fc (7 lx)	40.7' (12.4 m)	34.6' (10.6 m)
24' (7.3 m)	0.4 fc (4.3 lx)	48.8' (14.9 m)	41.5' (12.7 m)

LC ZDC - Illuminance at a Distance



Distance	Center Beam fc	Beam Width	
Feet (Meters)	Foot-Candles (Lux)	Vertical : 40.2 °	Horizontal : 38.1 °
4' (1.2 m)	10.8 fc (116 lx)	2.9' (0.9 m)	2.8' (0.9 m)
8' (2.4 m)	2.7 fc (29 lx)	5.9' (1.8 m)	5.5' (1.7 m)
12' (3.7 m)	1.2 fc (13 lx)	8.8' (2.7 m)	8.3' (2.5 m)
16' (4.9 m)	0.7 fc (8 lx)	11.7' (3.6 m)	11.0' (3.4 m)
20' (6.1m)	0.4 fc (4.3 lx)	14.6' (4.5 m)	13.8' (4.2 m)
24' (7.3 m)	0.32 fc (3.4 lx)	17.6' (5.4 m)	16.6' (5.1 m)

MOUNTING OPTIONS: Specify Separately

Mounts	Catalog No.		Mounts	Catalog No.	
Long Slot Spike	250015840000		Three-Prong Spike	250020020000	
Lock Ring	250030410000SP		Super Slot Spike	753900	
Straight Coupling	COUP-XX*		CE Certified Spike	eKitSpike	
90° Coupling	ELBW-050-XX*		Gutter Mount	GM-SS	
Ground Mount with 1/2" Thread	GM-XX*		Mini J-Box for 1/2" Thread	MJB-050-XX*	
Mini Mount	MM-050-XX*		ProAim® Ratcheting Spike	PARS	
Post Mount	PM-XX*		Super J-Box Spike	SJ-XX*	
TreeBox® Mount with 1/2" Thread	TB-XX*		T-Mount Coupling with 1/2" Thread	TMNT-050-XX*	
Tree Ring	TR-YY*-8P-XX*		VersaBox® Mount with 1/2" Thread	VB-050-XX*	
Variable Height Riser for Up Lights	VHR-UL		Wall Mount Knuckle	WM-XX*	
Single-Gang Wall Plate with 1/2" Thread	WP-1G-050-XX*		Round Wall Plate with 1/2" Thread	WP-RD-050-XX*	
1.0" (25 mm) Copper Riser for GT Path Light	YY*-R-GT-XX*		Sign Light Riser, Aluminum	YY*-R-SL-XX*	
Aluminum Riser, 3/4" Diameter	YY*-R-XX*				

LC LED Up Light ORDERING INFORMATION

POWER OPTIONS: Specify Separately

Power	Catalog No.	
Plug-In Transformer, 6 W	MT-6W	
Surge Protection Module	SURGE-MOD	
-		

Power	Catalog No.	
Step-Down Transformer, UV (120/277 V to 12 V)	ST-UV	