

User Manual AC-CX42-AUHD

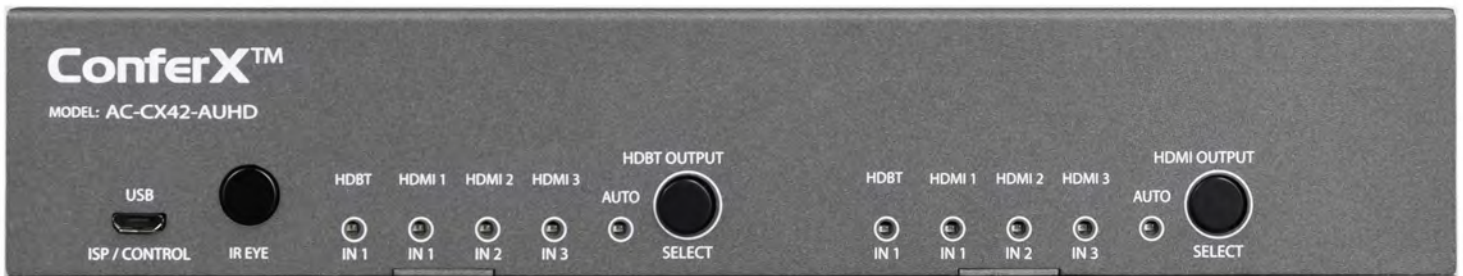

Introduction

The ConferX 4x2 Matrix Switcher is the ideal solution for any conference room, classroom or huddle space. This 4K switcher is able to display any of the four sources through both the HDBaseT or HDMI output port. Each of these outputs are completely independent of each other allowing to show two sources at the same time. With additional audio inputs and outputs you will have no problems working with a microphone or intercom system. When you need a stable solution for video distribution, look to the entire line of ConferX products.

With two HDBaseT inputs this switch works alongside two ConferX Wall Plate Transmitters at the same time. You can have Mini DisplayPort, HDMI, VGA or USB-C inputs located up to 100 meters away from the AC-CX42-AUHD. This allows a teacher or presenter to use their laptop directly at the podium or presenters' station without having to connect anything to the matrix switcher. The AC-CX42-AUHD gives any end user a simplified experience for sharing their ideas inside a classroom, conference room or huddle space.

Simple, intuitive and automatic control makes this unit the ideal "leave in the room" matrix. The unit features an "Auto" option where it defaults to the last plugged in device or simple one button control for each output. Prefer a control system? No problem, with a built-in web-based GUI and a full set of control commands you can make this switch work for you.

Features:

- HDMI 2.0(a/b)
- 18Gbps Bandwidth Support (HDMI and HDBaseT output)
 - **Note: 18Gbps on HDBaseT requires AC-EX70-444-RNE Receiver with ICT**
- 4K60 4:4:4 Support (HDMI and HDBaseT output)
- HDCP 2.2 (and all earlier versions supported)
- Advanced EDID Management
- Audio input and output
- Web based control GUI
- Works with 3rd party control (Control4, Crestron, Savant, etc)

Compatible AVProEdge HDBaseT products

HDBaseT Input/Transmitters	HDBaseT Output/Receivers
<ul style="list-style-type: none"> • AC-CXWP-HDMO-T • AC-CXWP-MDP-T • AC-CXWP-VGA-T • AC-CXWP-USBC-T 	<ul style="list-style-type: none"> • AC-EX70-UHD-R • AC-EX100-UHD-R3 • AC-EX70-444-RNE • AC-EX70-SC2-R

In The Box:

- AC-CX42-AUHD Matrix Switch
- IR Remote Control
- 48V/0.5A Power Supply
- 5 pin/3 pin Terminal Connectors
- Mounting Hardware



VIDEO:	
VIDEO RESOLUTIONS	UP TO 4K 60HZ 4:2:0 & 4K30 4:4:4
VESA RESOLUTIONS	UP TO 2560X2048 (QSXGA)
HDR FORMATS/RESOLUTIONS	4K24 4:2:2 12 BIT, 4K24 4:2:0 10 BIT
COLOR SPACE	YUV (COMPONENT), RGB (CSC: REC. 601, REC. 709, BT2020, DCI, P3 D6500)
CHROMA SUBSAMPLING	4:4:4, 4:2:2, 4:2:0 SUPPORTED
DEEP COLOR	UP TO 16 BIT (1080), UP TO 12 BIT (4K)
AUDIO:	
AUDIO FORMATS SUPPORTED HDMI	PCM 2.0 CH, LPCM 5.1 & 7.1, DOLBY DIGITAL, DTS 5.1, DOLBY DIGITAL PLUS, DOLBY TRUEHD, DTS-HD MASTER AUDIO, DTS-X, DOLBY ATMOS
AUDIO FORMATS SUPPORTED EXTRACTED (TOSLINK)	PCM 2.0 CH, LPCM 6 CH, LPCM 7 CH, DOLBY DIGITAL, DOLBY DIGITAL PLUS, DTS- MASTER AUDIO
AUDIO FORMATS SUPPORTED EXTRACTED (2CH PORT)	PCM 2 CH (NO DOWNMIX)
AUDIO EXTRACTION LOCATION	BIND TO INPUT, BIND TO OUTPUT OR MATRIX (INDEPENDENT)
AUDIO DELAY (PER OUTPUT, EXTRACTED)	UP TO 630MS
DISTANCE:	
AC-CXWP-HDMO-T (10.2 GBPS)	100 METERS 1080P, 70 METERS 4K@10.2 GBPS (CAT 6A)
AC-CXWP-MDP-T (10.2 GBPS)	100 METERS 1080P, 70 METERS 4K@10.2 GBPS (CAT 6A)
AC-CXWP-VGA-T (10.2 GBPS)	100 METERS 1080P, 70 METERS 4K@10.2 GBPS (CAT 6A)
AC-EX100-UHD-T (10.2 GBPS)	100 METERS 1080P, 70 METERS 4K@10.2 GBPS (CAT 6A)
AC-EX100TT-UHD (10.2 GBPS)	100 METERS 1080P, 70 METERS 4K@10.2 GBPS (CAT 6A)
AC-CX100-RAMP (18 GBPS)	100 METERS 1080P, 70 METERS 4K@18 GBPS (CAT 6A)
AC-EX70-444-RNE (18 GBPS)	100 METERS 1080P, 70 METERS 4K@18 GBPS (CAT 6A)
AC-EX100-UHD-R3 (10.2 GBPS)	100 METERS 1080P, 70 METERS 4K@18 GBPS (CAT 6A)
AC-CX70-UHD-R (10.2 GBPS)	70 METERS 1080P, 40 METERS 4K@10.2 GBPS (CAT 6A)
AC-EX70-SC2-R (18 GBPS)	100 METERS 1080P, 70 METERS 4K@18 GBPS (CAT 6A)
OTHER:	
BANDWIDTH HDMI	18 GBPS UNCOMPRESSED
BANDWIDTH HDBASET	(SEE OPTIONS UNDER DISTANCE DIRECTLY ABOVE)
HDCP	HDCP 2.2 AND EARLIER
POH FOR RECEIVERS (NO NEED TO POWER RECEIVERS)	YES, ALL OUTPUTS
CONTROL:	
PORTS	LAN, RS232, IR, MICRO USB
LAN WEBOBS	YES
PORTS:	
HDMI	TYPE A
LAN	RJ45 W/ WEB INTERFACE/ CONTROL
AUDIO (EXTRACTED DIGITAL)	TOSLINK
AUDIO (EXTRACTED ANALOG)	5 PIN TERMINAL BLOCK (BALANCED)
IR RX	3.5MM STEREO (3-CONDUCTOR)
RS232	3 PIN TERMINAL BLOCK
ENVIRONMENTAL:	
OPERATING TEMPRATURE	23 TO 125°F (-5 TO 51°C)
STORAGE TEMPERATURE	-4 TO 140°F (-20 TO 60°C)
HUMIDITY RANGE	5-90% RH (NO CONDENSATION)
POWER:	
POWER CONSUMPTION (TOTAL)	65 WATTS MAX
POWER SUPPLY - MATRIX	INPUT: AC 100-240V ~ 50/60HZ OUTPUT: DC 48V 2.7A
DIMENSIONS:	
DIMENSIONS (UNIT ONLY - HEIGHT/DEPTH/WIDTH)	MM: 50.8 X 260.35 X 441.33 INCH: 2 X 10.25 X 17.375
DIMENSIONS (PACKAGED LENGTH/WIDTH/HEIGHT)	MM: 88.9 X 444.5 X 495.3 INCH: 3.5 X 17.5 X 19.5
RACK UNITS	1 UNIT
WEIGHT (UNIT)	7.4 LBS (3.36 KG)
WEIGHT (PACKAGED)	9.6 LBS (4.35 KG)
*SPECIFICATIONS SUBJECT TO CHANGE WITHOUT NOTICE. MASS & DIMENSIONS ARE APPROXIMATE	

Introduction, Features, In the Box..... 2

Specifications..... 3

Device Overview.....5

Front Panel Control..... 6

RS-232/USB Control/Cable Prep..... 7

RS-232 and TCP/IP Commands.....8

Command Example: DHCP and setting the IP Address...8

Command List..... 9

IR..... 10-11

Extracted Audio..... 12

Microphone/Line In..... 13

Web OS.....14-16

Connection Diagram Example..... 16

Maintenance, Damage Requiring Service.....17

Support, Warranty.....18

Troubleshooting.....19

Device Overview

FRONT

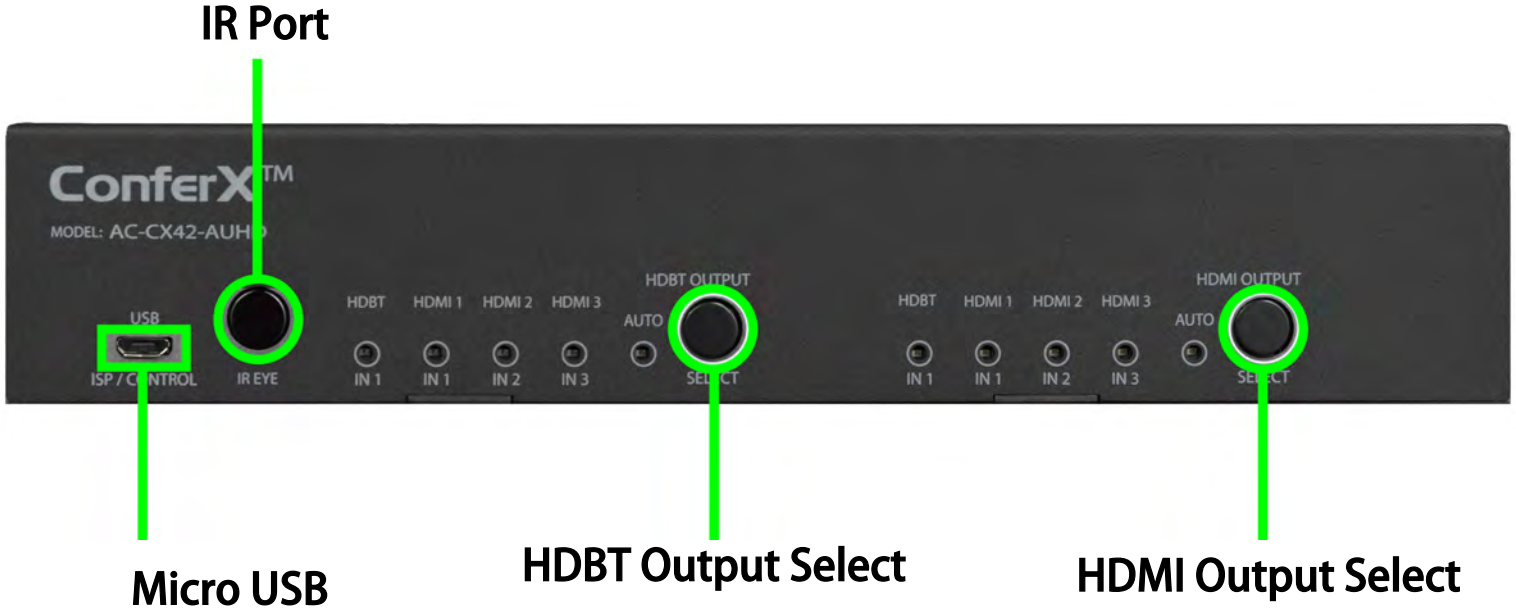

BACK

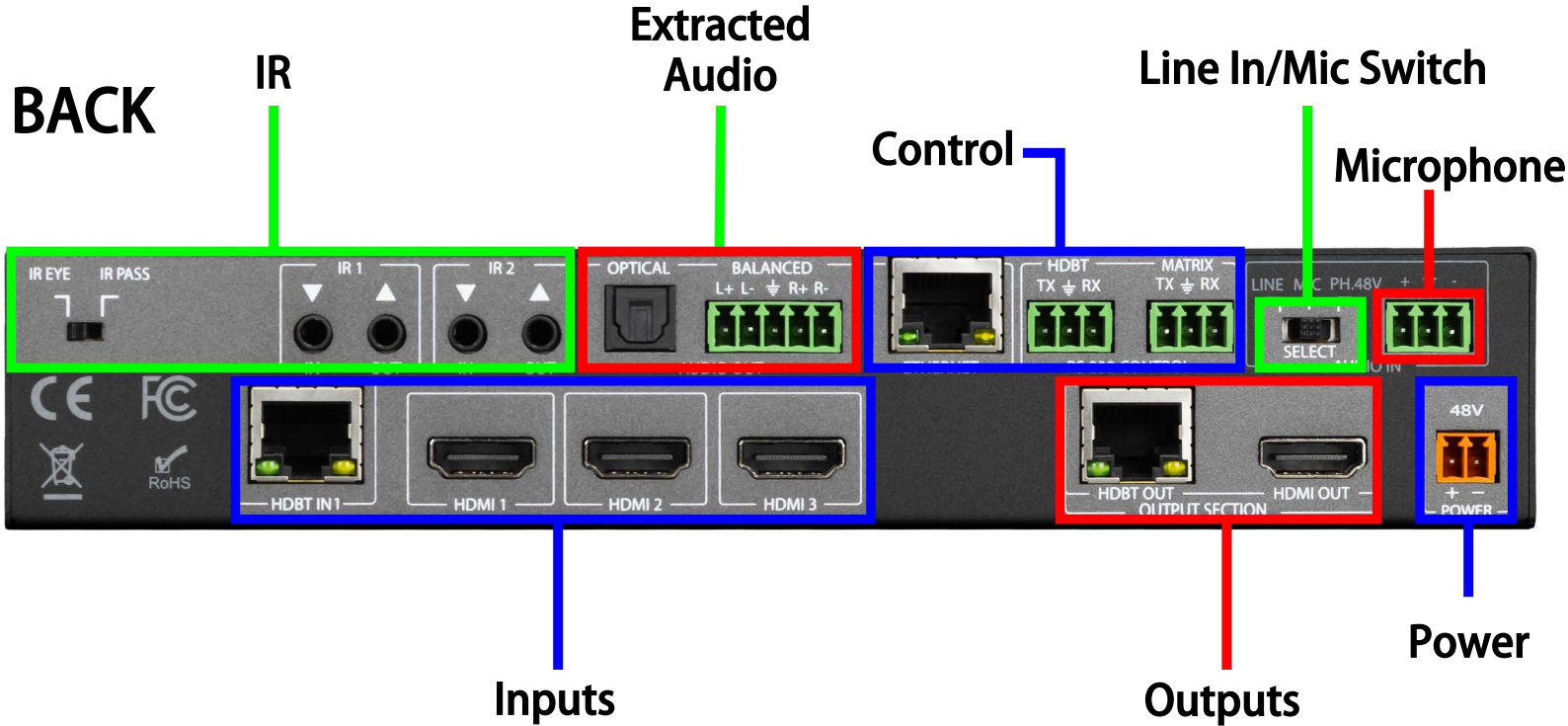

Basic Installation:

The unit has an Auto-Config on boot up and reception of new sources and displays to maximize plug and play installation:

1. Plug in the display(s) or sink devices
2. Plug in the sources
3. Plug in the power supply to the AC-CX42-AUHD

4. Power on the Sources and Display(s)

This will ensure proper EDID application across the device.

Basic Control Using Front Panel:

Switching:

The AC-CX42-AUHD can be switched from the front panel by pressing the corresponding OUTPUT SELECT button:

1. Press the HDBT OUTPUT SELECT button to cycle through the four Inputs
2. Press the HDMI OUTPUT SELECT button to cycle through the four Inputs
3. Press and hold the desired OUTPUT SELECT button (HDBT or HDMI) for 3 seconds to Enable/Disable AUTO SWITCH MODE (all INPUT LEDs will flash)
 - a. AUTO SWITCH Enabled - AUTO LED ON
 - b. AUTO SWITCH Disabled - AUTO LED OFF

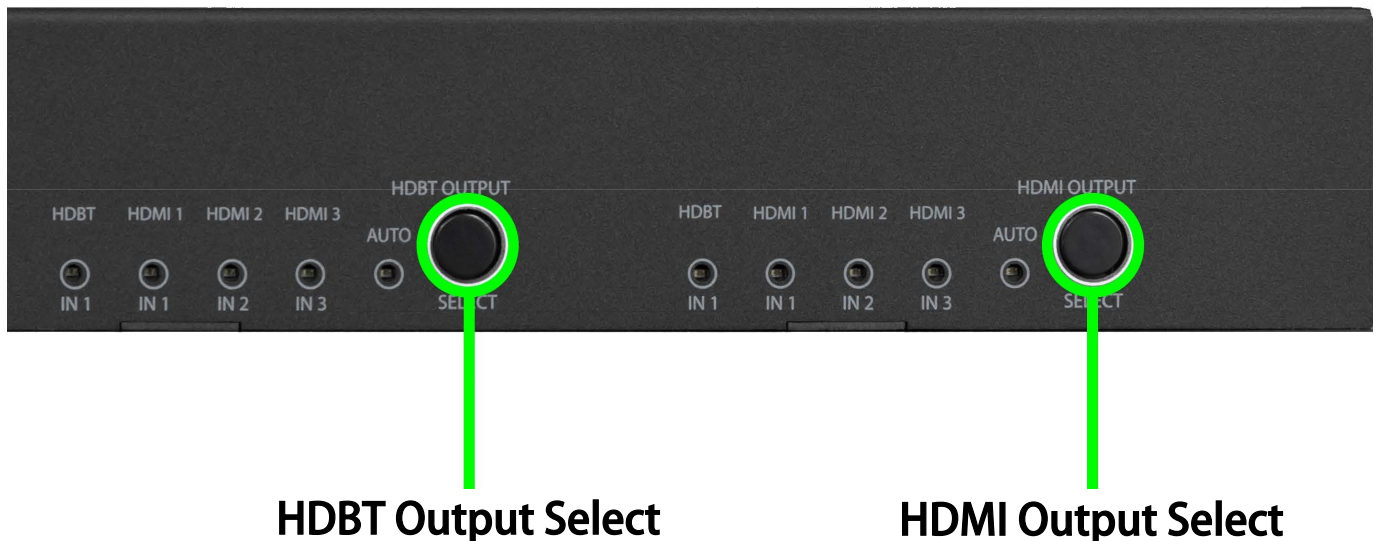

Auto-Switching Logic

When the AC-CX42-AUHD is in "Auto" mode the logic is to switch to the most recently plugged in device based on a Hot Plug Event. You can have either the HDMI, HDBaseT, or both be set to "Auto" mode.

AC-CX42-AUHD

RS232 Configuration:

The AC-CX42-AUHD two distinct RS232 Ports:

1. HDBT - This is for transmitting RS232 signals from the Matrix to the remote HDBaseT Receiver
2. MATRIX - This is for sending signals to the AC-CX42-AUHD Matrix for controlling the device. An example is shown on the next page. The complete command list is on page after that.

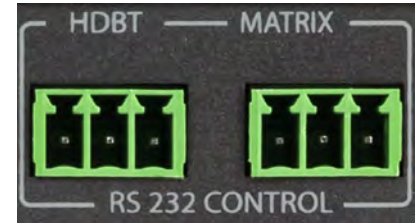

ISP / CONTROL

This ConferX switch can also be controlled using a computer and a micro USB cable, using the Micro USB Port on the front of the device.

USB CONTROL FOR AVPRO EDGE

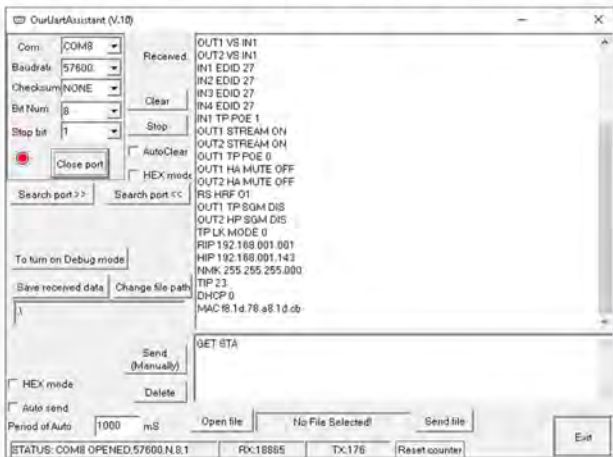

WWW.AVPROEDGE.COM/DRIVERS

OTHER TOOLS & DRIVERS

myUart Serial Communicator: Used to send direct serial commands to our products.

Universal FTDI USB to Serial Converter: Used with SDC/S2K-A & Fox & Hound and several USB to Serial converters supplied by AVPro Edge

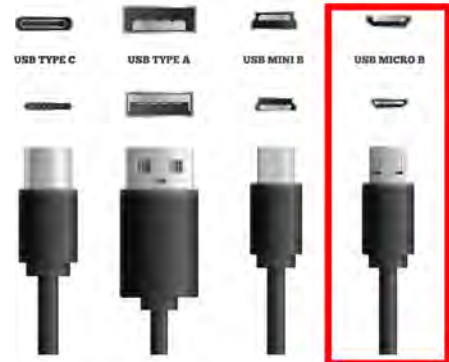

RS-232 CABLE FOR AVPRO EDGE

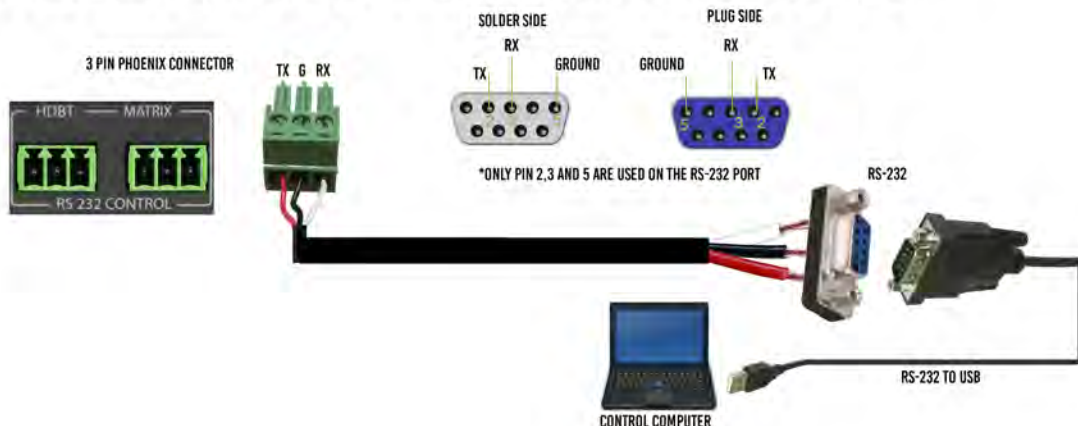

RS-232 and TCP/IP Commands:

The Matrix can be controlled with either RS-232 or TCP/IP commands. Certain switching or format configurations can only be done using these commands. We recommend using either the MyUART (RS-232 - free) or Hercules (TCP/IP - free) apps as they are very easy to use for sending commands to the machine.

For TCP/IP control commands use Telnet Port 23.

For RS-232, use a null modem serial cable adapter and set the serial communications to:

57600,n,8,1 (baud: 57600, no parity, 8 data bits and 1 stop bit) with no handshaking.

Please add a return (Enter key) after each command when using direct commands. The unified command list (ASCII) is listed on the next page.



Command Example: DHCP and setting the IP Address

1. Connect your computer to one of the control ports (Micro USB/3pin Terminal)
2. Open up MyUart and verify the correct settings
 - a. Baudrate: 57600, no parity, 8 data bits and 1 stop bit) with no handshaking.
3. On MyUart click Search Port>> (you will see a red indicator once connected)
 - a. You can verify the COM port by using Windows Device Manger. Both USB and 3pin connections should show up as a COM#.
4. Send "GET DHCP" with a carriage return (no " " and hit Enter/Return on keyboard).
 - a. Default is OFF so the return message should be "DHCP 0" (0=Off, 1=On)
5. Send "SET DHCP 1", the return message should read "DHCP 1"
 - a. This will also return the current IP Settings. If there is no connection it will reply with the Default Settings.
6. You can now connect to the WebUI by typing in the HIP address into a web browser. There you can alter the IP address of the Matrix to one of your choosing.
7. You can also set the address of the matrix by sending the following command
 - a. "SET HIP xxx.xxx.xxx.xxx" (SET HIP 192.168.1.143)
8. Once configured it is recommended to turn DHCP back off so the settings are set to Static and will not change (this can also be done from the WebUI).
 - a. "SET DHCP 0"
9. You can verify the settings by getting the status of the matrix
 - a. "GET STA"

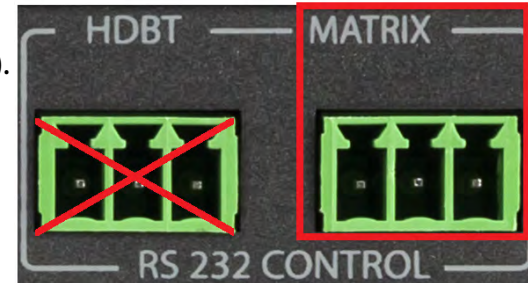

```
DHCP 0
DHCP 1
HIP 192.168.001.239
RIP 192.168.001.001
NMK 255.255.255.000
```

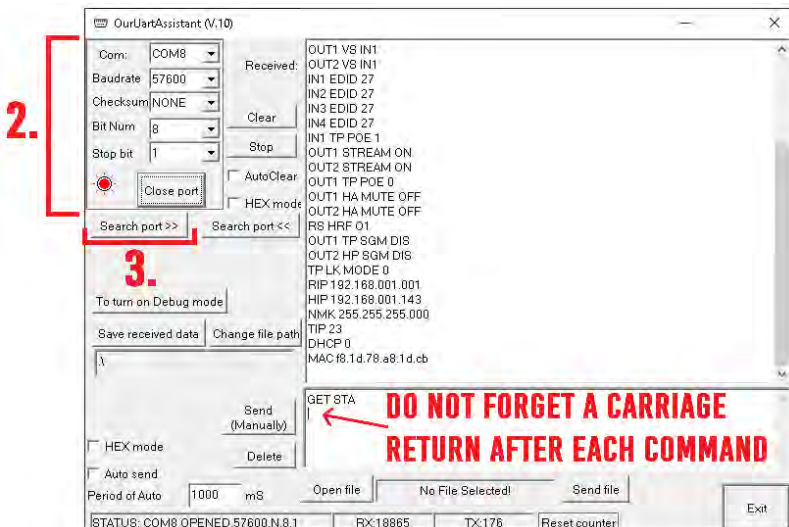

- > Portable Devices
- > Ports (COM & LPT)
 - USB-SERIAL CH340 (COM8)
- > Print queues

Command	Action	
H	: Help	
STA	: Show Global System Status	
SET RBT	: System Reset to Reboot	
SET RST	: Reset to Factory Defaults	
SET ADDR xx	: Set System Address to xx {xx=[00-99](0=Single)}	
GET ADDR	: Get System Address	
GET STA	: Get System System Status	
GET INx SIG STA	: Get Input x Signal Status{x=[0~4](0=ALL)}	
Output Setup Commands		
SET OUTx VS INy	: Set Output x To Input y{x=[0~2](0=ALL), y=[1~4]}	
SET OUT1 VIDEOy	: Set Output1 VIDEO Mode {y=[2,5](2=4K->2K,5=ICT Mode)}	
SET EXA BTV OUTx	: Set Ex-Audio Output bind to Outputx{x=[1~2]}	
SET SWITCH MODEx	: Set Switch Mode To Single Switch or Double Switch{x=[0~1]}	
SET OUTx EXA EN/DIS	: Set Ex-Audio Output Enable/Disable{x=[0~1](0=ALL)}	
SET OUTx EXAUD LEVY	: Set Output x Ex-Audio(Balanced) Volume Levely{x=[0~1](0=ALL),y=[0~20]}	
SET OUT1 EXA MIC EN/DIS	: Set EX-Audio Route to Microphone Input Enable/Disable	
SET OUTx STREAM ON/OFF	: Set Output x Stream ON/OFF{x=[0~2](0=ALL)}	
SET OUT1 TP POE y	: Set Output1 POE Mode{y=[0~1](0=Auto,1=Force)}	
SET OUTx HA MUTE ON/OFF	: Set HDMI Output x Audio Mute ON/OFF{x=[0~2](0=ALL)}	
SET OUT1 TP SGM EN/DIS	: Set HDBT Output Signal Generator Enable/Disable	
SET OUT2 HP SGM EN/DIS	: Set HDMI Output Signal Generator Enable/Disable	
GET OUTx VS	: Get Output x Video Route{x=[0~2](0=ALL)}	
GET OUT1 VIDEO	: Get Output1 Video Mode	
GET EXA BTV OUT	: Get Ex-Audio Output bind to Which Output	
GET SWITCH MODE	: Get Switch Mode	
GET OUTx EXA	: Get Ex-Audio Output Enable/Disable Status{x=[0~1](0=ALL)}	
GET OUTx EXAUD LEV	: Get Output x Ex-Audio(Balanced) Volume Level{x=[0~1](0=ALL)}	
GET OUT1 EXA MIC	: Get EX-Audio Route to Microphone Input Enable/Disable Status	
GET OUTx EDID DATA	: Get Output x EDID DATA{x=[1~2]}	
GET OUTx STREAM	: Get Output x Stream ON/OFF Status{x=[0~2](0=ALL)}	
GET OUT1 TP POE	:Get Output1 POE Mode	
Get OUTx HA MUTE	:Get HDMI Output x Audio Mute Status{x=[0~2](0=ALL)}	
GET OUT1 TP SGM	: Get HDBT Output Signal Generator Enable/Disable Status	
GET OUT2 HP SGM	: Get HDMI Output Signal Generator Enable/Disable Status	
Input Setup Commands		
SET INx EDID y	: Set Input x EDID{x=[0~4](0=ALL), y=[0~32]}	
0:1080P_2CH(PCM)	1:1080P_6CH	2:1080P_8CH
3:1080P_3D_2CH(PCM)	4:1080P_3D_6CH	5:1080P_3D_8CH
6:4k30Hz_3D_2CH(PCM)	7:4k30Hz_3D_6CH	8:4k30Hz_3D_8CH
9:4K60Hz(Y420)_3D_2CH(PCM)	10:4K60Hz(Y420)_3D_6CH	11:4K60Hz(Y420)_3D_8CH
12:4K60Hz_3D_2CH	13:4K60Hz_3D_6CH	14:4K60Hz_3D_8CH
15:1080P_2CH(PCM)_HDR	16:1080P_6CH_HDR	17:1080P_8CH_HDR
18:1080P_3D_2CH(PCM)_HDR	19:1080P_3D_6CH_HDR	20:1080P_3D_8CH_HDR
21:4K30Hz_3D_2CH(PCM)_HDR	22:4K30Hz_3D_6CH_HDR	23:4K30Hz_3D_6CH_HDR
24:4K60Hz(Y420)_3D_2CH(PCM)_HDR	25:4K60Hz(Y420)_3D_6CH_HDR	26:4K60Hz(Y420)_3D_8CH_HDR
27:4K60Hz_3D_2CH(PCM)_HDR	28:4K60Hz_3D_6CH_HDR	29:4K60Hz_3D_8CH_HDR
30:USER1_EDID	31:USER2_EDID	32:USER3_EDID
SET INx EDID CY Outy	: Copy Output y EDID To Input x(USER1 BUF){x=[0~4](0=ALL), y=[1~2]}	
SET INx EDID UY DATAz	: Write EDID To User y Buffer of Input x{x=[0~4](0=ALL), y=[1~3],z=[EDID Data]}	
SET IN1 TP POE y	: Set IN1 POE Mode{y=[0~1](0=Auto,1=Force)}	
GET INx EDID	: Get Input x EDID Index{x=[0~4](0=ALL)}	
GET INx EDID y DATA	: Get Input x EDID y Data{x=[1~4],y=[0~32]}	
GET IN1 TP POE	: Get IN1 POE Mode	
Auto mode		
SET HDx AUTO EN/DIS	: Set HDMI1/HDMI2 Output Enter Auto Mode Control Enable/Disable {x=0(HDMI1&HDMI2 Output),x=1(HDMI1 Output),x=2(HDMI2 Output)}	
GET HDx AUTO	: Get HDMI1/HDMI2 Output Auto Mode Control Status	
Network Setup Command (xxx=[000-255], zzzz=[0001~9999]		
SET RIP xxx.xxx.xxx.xxx	:Set Route IP Address to xxx.xxx.xxx.xxx	
SET HIP xxx.xxx.xxx.xxx	: Set Host IP Address to xxx.xxx.xxx.xxx	
SET NMK xxx.xxx.xxx.xxx	: Set Net Mask to xxx.xxx.xxx.xxx	
SET TIP zzzz	: Set TCP/IP Port to zzzz	
SET DHCP y	: Set DHCP {y=[0~1](0=Dis,1=Enable)}	
GET RIP	: Get Route IP Address	
GET HIP	: Get Host IP Address	
GET NMK	: Get Net Mask	
GET TIP	: Get TCP/IP Port	
GET DHCP	: Get DHCP Status	
GET MAC	: Get MAC Address	
RS232 Route Setup Command		
SET RS HRF 1x/Ox	: Set HDBT RS232 RX From Input or Output Port x{x=[1](1=Input,0=Output)}	
SET RS PTH OUTx LENy BRz	: Set RS232 Pass Through to Output x {x=[1],y=[1~100],z=[0~5](0=9600,1=14400,2=19200,3=38400,4=57600,5=115200)}	
SET RS PTH INx LENy BRz	: Set RS232 Pass Through to Input x {x=[1],y=[1~100],z=[0~5](0=9600,1=14400,2=19200,3=38400,4=57600,5=115200)}	
GET RS HRF	: Get HDBT RS232 RX From Port State	
IR Code Setup Command		
SET IR SYS xx.yy	: Set IR Custom Code{xx=[00-FFH],yy=[00-FFH]}	
SET IR OUTx INy CODE zz	: Set IR Data Code{x=[1~2],y=[1~4],zz=[00-FFH]}	
GET IR SYS	: Get IR Custom Code	
GET IR OUTx INy CODE	: Get IR Data Code	

IR Configuration

IR Mode Slide Switch: (On Back) This is used to select a preferred IR Mode - There are two modes:

- IR-EYE - The IR Input will be configured to operate with an IR Receiver Eye.
- IR PASS - The IR Input will be configured to safely operate with a direct connection from a control system using a mono or stereo 3.5mm cable. It's protected @ 3v-20v. Default mode is IR-EYE.

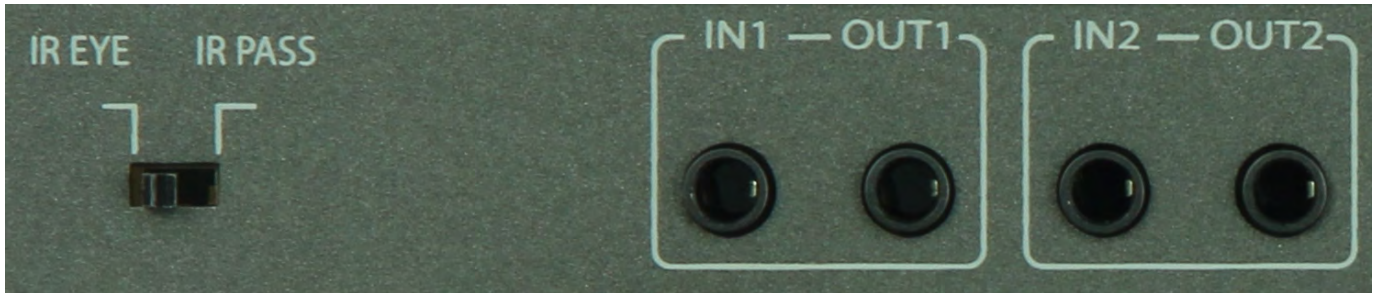

NOTE: IN1/OUT1 is for the HDBaseT Input (IN1).
 IN2/OUT2 is for the HDBaseT Output (OUT1)

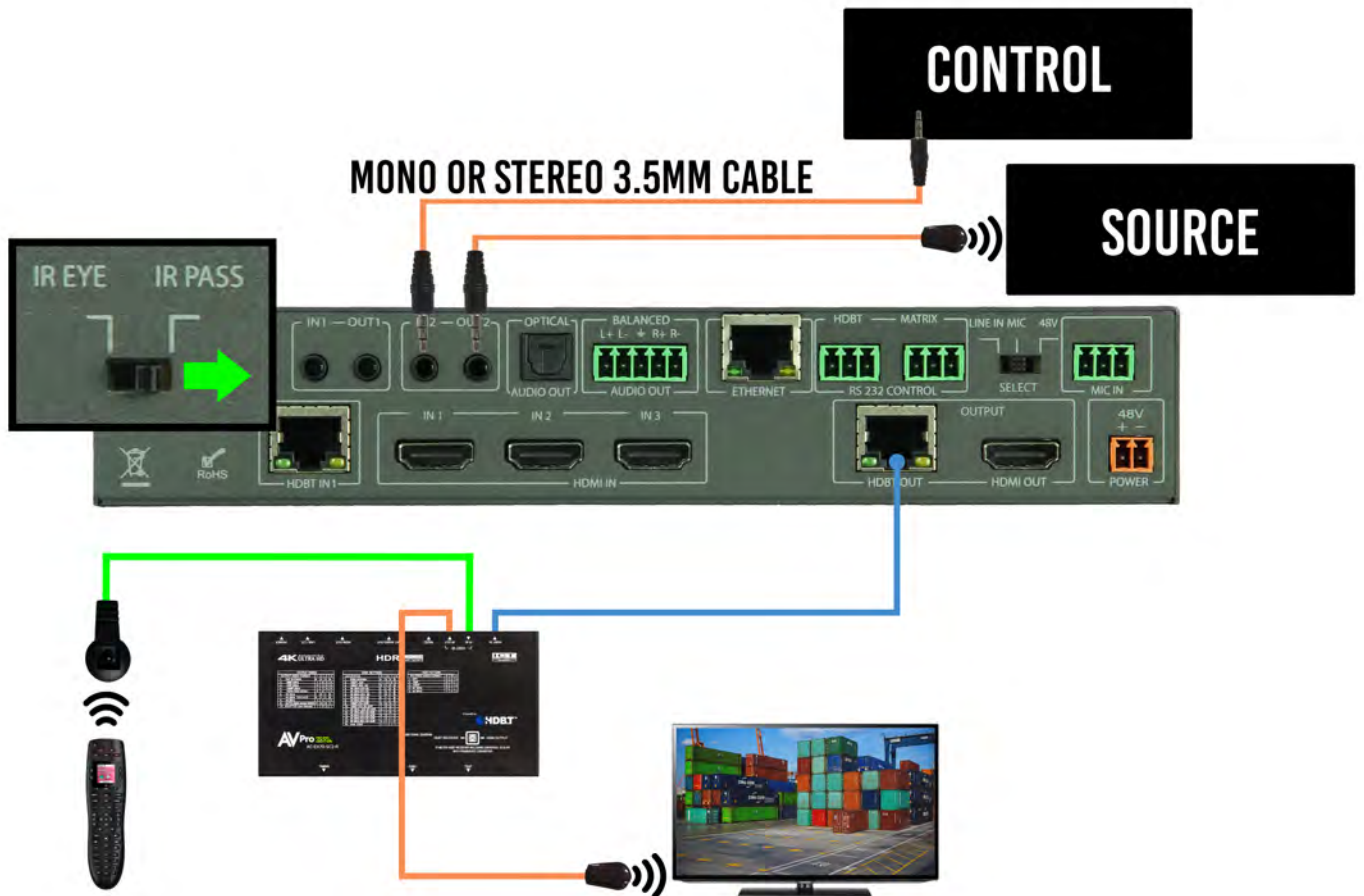

IR Configuration Cont.

IR OUT - The two IR OUT ports send IR signals out of an IR Emitter (Pictured below) that originate at the HDBaseT Receiver OR HDBaseT Transmitter

IR Sensor:



TO CONTROL SYSTEM

IR IN (IR PASS)

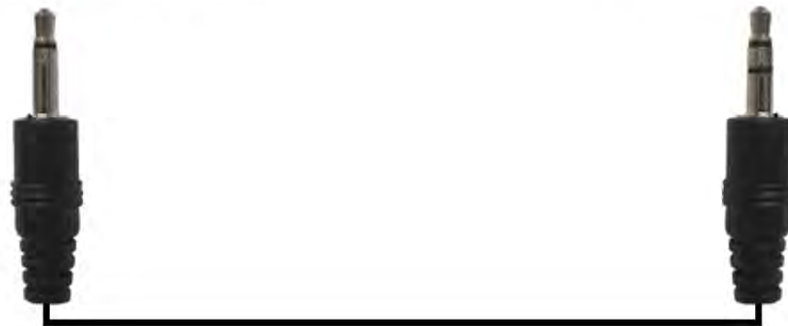

IR Emitter:



Audio Output Logic and Cable Prep:

You can extract audio from toslink or balance 2CH Audio. Audio outputs are an un-decoded output. This means that what goes in, is what goes out.

2CH Balanced Audio Port - Supports 2CH PCM audio only, which is ideal for 2 Channel systems and zoned audio systems.

Toslink Audio Port - Supports PCM, LPCM (up to 7CH), Dolby Digital, Dolby Digital Plus, DTS, DTS-HD, DTS Master Audio, which is ideal for multi-channel audio systems and older AVR's that do not support 18Gbps.

Need to down-mix for combination, uncompressed and 2CH systems? Check out the AC-ADM-AUHD and AC-ADM-COTO.

You can use balanced analog outputs in a balanced system, but you can also prep a cable as shown below to convert to a traditional 2CH unbalanced (L/R) system.

You can also purchase pre-made cables (AC-CABLE-5PIN-2CH)

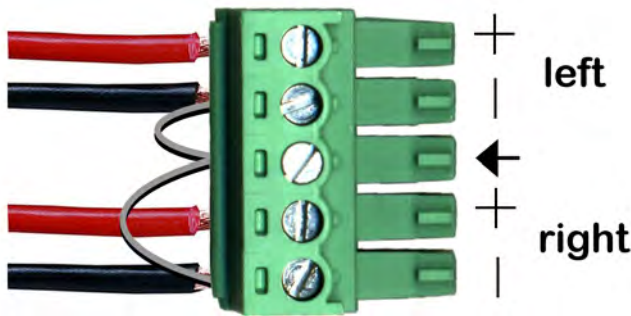

***NOTE: Make sure ground is always connected**

AUDIO DIAGRAM

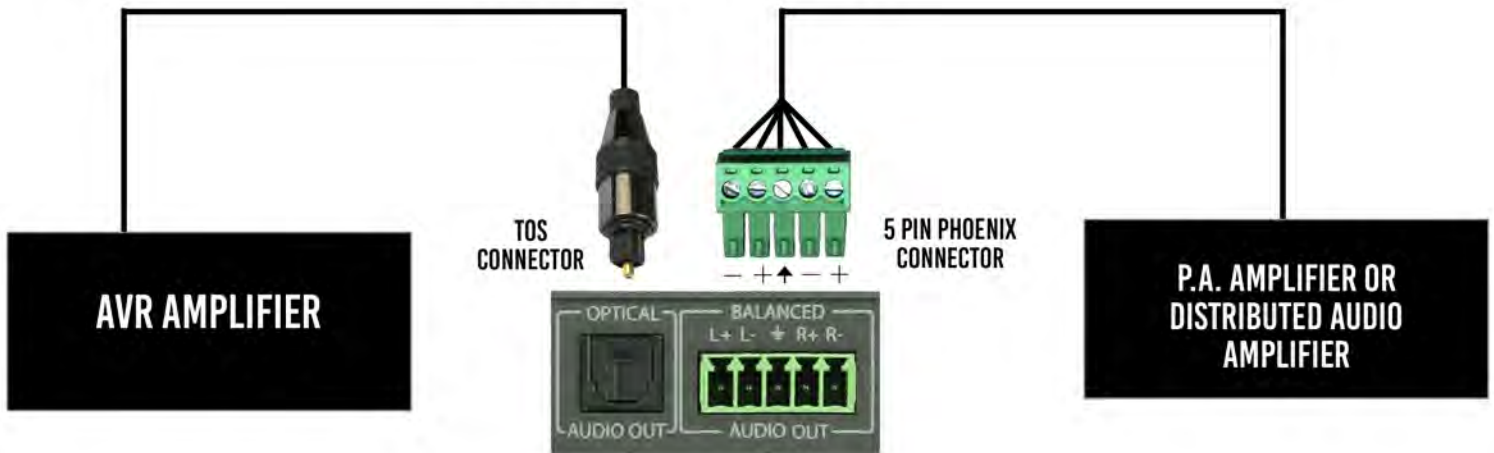

1. LINE IN - Balance Mono Analog Audio Input (use + and Ground \perp)
 - a. VPP should be less than 2 Volts
2. MIC - Select this for non-powered or Dynamic microphones.
3. 48V - This if for Microphones that require Phantom Power (Condenser Microphones)

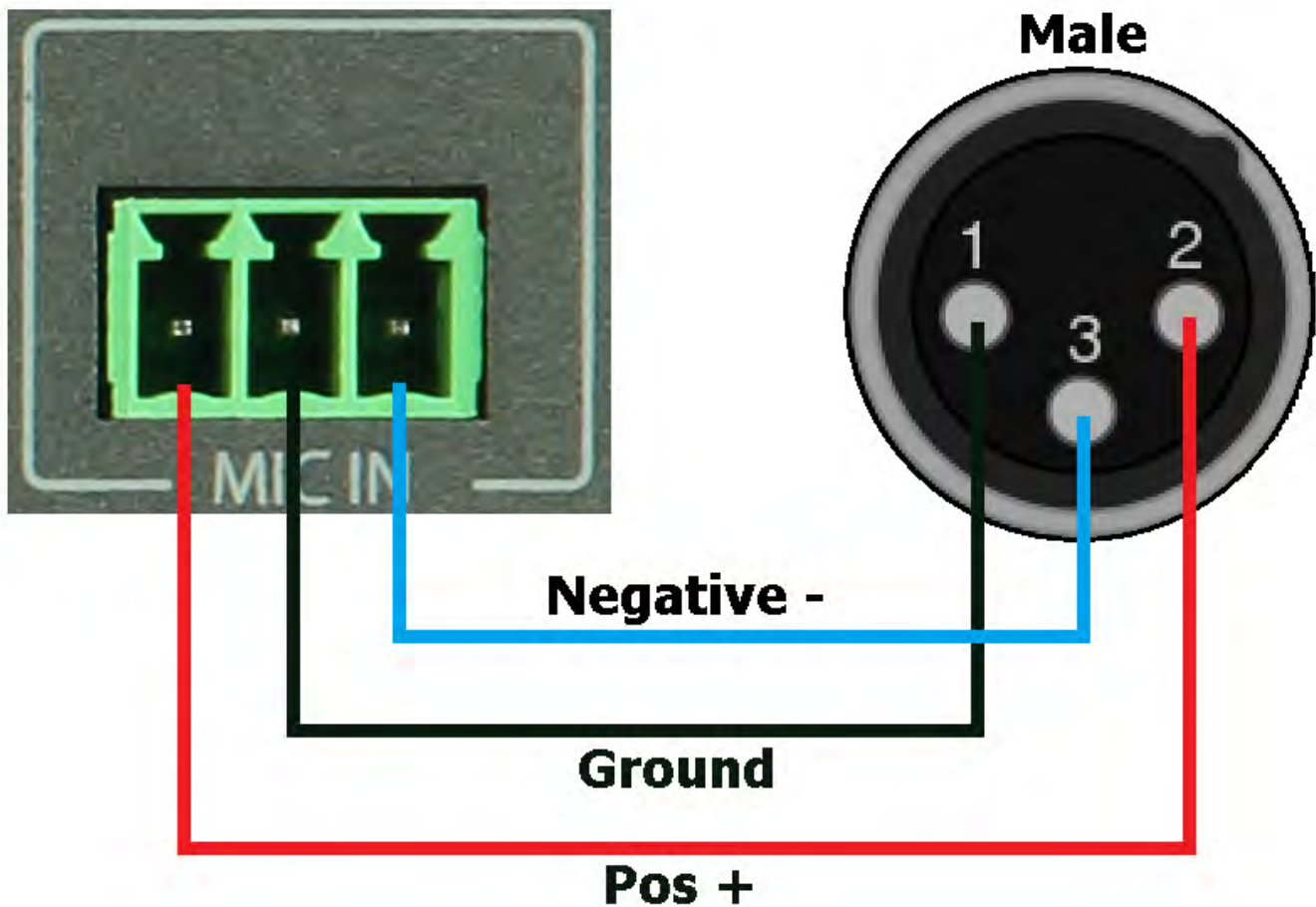
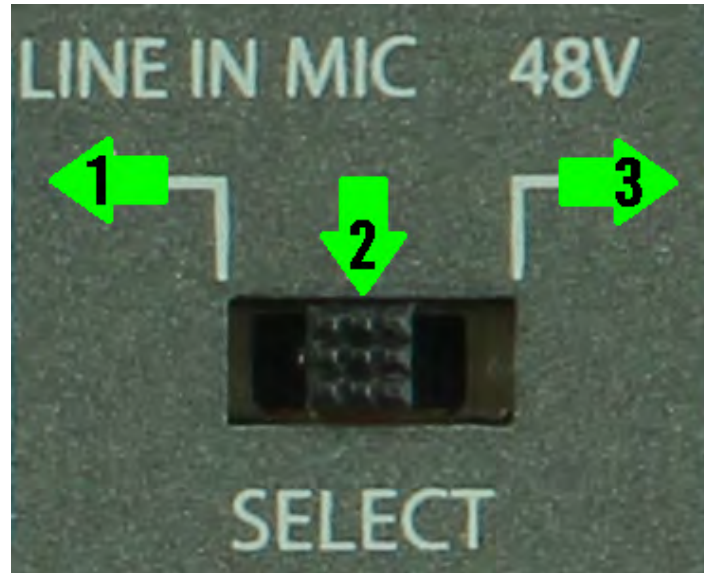

Web OS Overview

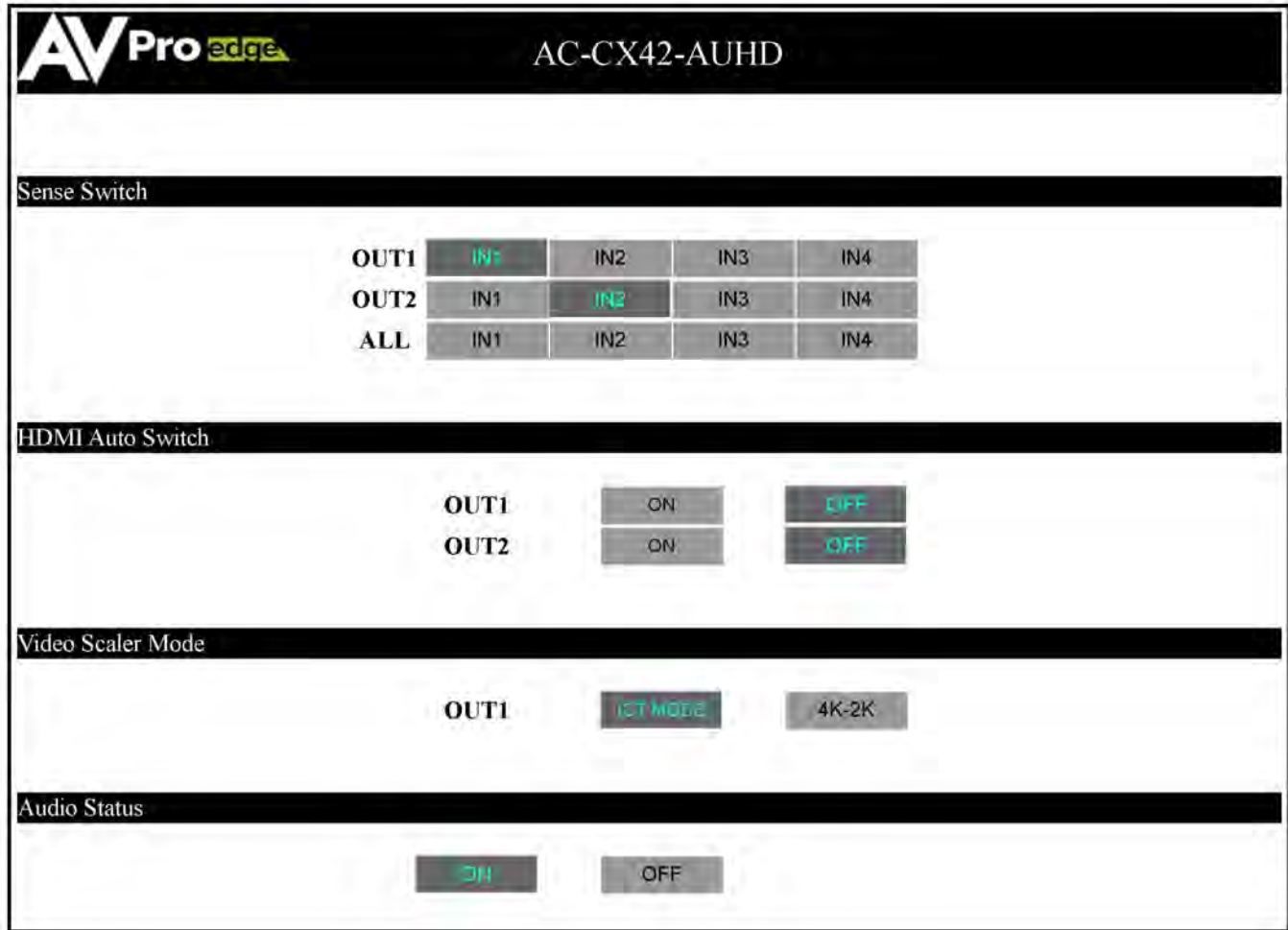

Sense Switch

Use this to switch between inputs and outputs from the web interface.

HDMI Auto Switch

Use this to turn HDMI Auto Sense Switching ON/OFF per output.

Video Scaler Mode

With the video scaler mode, you can scale the HDBaseT output (OUT1)

- 4K-2K - If incoming signal is 4K, it will be downscaled to 1080P or 1900x1200 depending on the input format.
- ICT MODE = ICT Mode (Enables ICT (18G) Compression mode on HDBT Port) - **DEFAULT**.

Audio Status

Use this to turn the extracted audio ports ON/OFF.

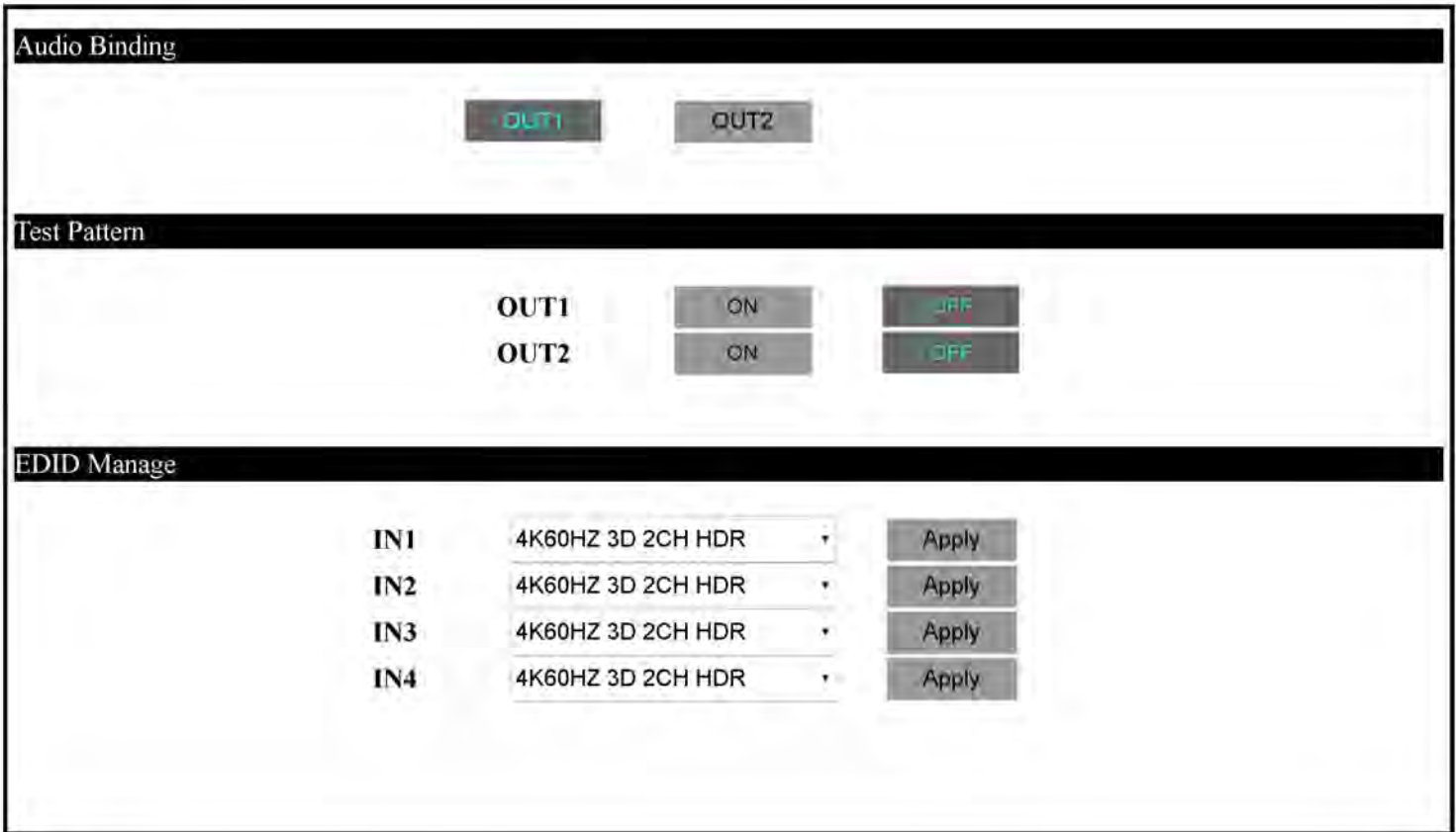

Audio Binding

Use this to select what Output the Audio Follows.

Test Pattern

Use this to turn the built in Test Pattern Generator ON/OFF for each output.

EDID Manage

Use this to select the EDID for each INPUT (*default is 1080p 2ch*)

- Select from the Drop-down list, then click "Apply".

1080P_2CH(PCM)	4K60HZ_3D_2CH	4K60Hz(Y420)_3D_2CH(PCM)_HDR
1080P_6CH	4K60HZ_3D_6CH	4K60Hz(Y420)_3D_6CH_HDR
1080P_8CH	4K60HZ_3D_8CH	4K60Hz(Y420)_3D_8CH_HDR
1080P_3D_2CH(PCM)	1080P_2CH(PCM)_HDR	4K60Hz_3D_2CH(PCM)_HDR
1080P_3D_6CH	1080P_6CH_HDR	4K60Hz_3D_6CH_HDR
1080P_3D_8CH	1080P_8CH_HDR	4K60Hz_3D_8CH_HDR
4k30Hz_3D_2CH(PCM)	1080P_3D_2CH(PCM)_HDR	USER1_EDID
4k30Hz_3D_6CH	1080P_3D_6CH_HDR	USER2_EDID
4k30Hz_3D_8CH	1080P_3D_8CH_HDR	USER3_EDID
4K60Hz(Y420)_3D_2CH(PCM)	4K30Hz_3D_2CH(PCM)_HDR	Copy From OUT1
4K60Hz(Y420)_3D_6CH	4K30Hz_3D_6CH_HDR	Copy From OUT2
4K60Hz(Y420)_3D_8CH	4K30Hz_3D_6CH_HDR	

System Setting

IP Setting

MAC Address: FB:1D:78:A8:1E:17

Host IP Address: 192.168.1.239

Subnet Mask: 255.255.255.0

Router IP Address: 192.168.1.1

TCP Port: 23

DHCP
 Static IP

Port Alias Setting

OUT1	OUT1	IN1	IN1
OUT2	OUT2	IN2	IN2
		IN3	IN3
		IN4	IN4

System Setting

IP Settings - Default is **"Static IP"** with the following

- Host IP Address 192.168.1.239
- Subnet Mask 255.255.255.0
- Router IP Address 192.168.1.1
- TCP Port 23

Port Alias Setting

Here you can re-label the individual Input/Outputs

****Note - There is a 7 Character limit****

Re-label, then click **"Apply"**

▪ Maintenance

To ensure reliable operation of this product as well as protecting the safety of any person using or handling this device while powered, please observe the following instructions.

- Use the power supplies provided. If an alternate supply is required, check voltage, polarity and that it has sufficient power to supply the device it is connected to.
- Do not operate these products outside the specified temperature and humidity range given in the above specifications.
- Ensure there is adequate ventilation to allow this product to operate efficiently.
- Repair of the equipment should only be carried out by qualified professionals as these products contain sensitive components that may be damaged by any mistreatment.
- Only use this product in a dry environment. Do not allow any liquids or harmful chemicals to come into contact with these products.
- Clean this unit with a soft, dry cloth. Never use alcohol, paint thinner or benzene to clean this unit.

▪ Damage Requiring Service

- The DC power supply cord or AC adaptor has been damaged
- Objects or liquids have gotten into the unit
- The unit has been exposed to rain
- The unit does not operate normally or exhibits a marked change in performance
- The unit has been dropped or the housing damaged

■ Support

Should you experience any problems while using this product, first, refer to the Troubleshooting section of this manual before contacting Technical Support. When calling, the following information should be provided:

- Product name and model number
- Product serial number
- Details of the issue and any conditions under which the issue is occurring

■ Warranty

If your product does not work properly because of a defect in materials or workmanship, AVProEdge (referred to as “the warrantor”) will, for the length of the period indicated as below, (Parts/Labor (10) Years), which starts with the date of original purchase (“Limited Warranty period”), at its option either (a) repair your product with new or refurbished parts, or (b) replace it with a new or a refurbished product. The decision to repair or replace will be made by the warrantor. During the “Labor” Limited Warranty period there will be no charge for labor. During the “Parts” warranty period, there will be no charge for parts. You must mail-in your product during the warranty period. This Limited Warranty is extended only to the original purchaser and only covers product purchased as new. A purchase receipt or other proof of original purchase date is required for Limited Warranty service.

▪ Troubleshooting

- Verify Power - The HDBT and HDMI INPUT Select blue LEDs on the front will always be on when powered.
- Verify Connections - Check that all cables are properly connected
- HDBaseT Transmitters/Receivers not powering from the Matrix, try changing the POE setting from AUTO to Forced (command list Page 9).
 "SET OUT0 TP POE 1" - This will change the two HDBaseT Outputs to Forced (0=All).
 "SET IN0 TP POE 1" - This will change the two HDBaseT Inputs to Forced (0=All).
- Issues with one INPUT/OUTPUT - Swap ports/cables/etc to help narrow down if the issue stays with the input/output/etc
 - Follows the device, then it may be an EDID issue. Default out of the box is a 1080p 2ch. Try another canned EDID or use the COPY FROM OUTx command to copy the connected displays EDID - Pg.9 and 15
- Issues with 4k but 1080p or less is working
 - Verify all connected devices are capable of the signal you are sending. See chart on page 20 for details.

**POE SETTINGS WHEN USING AC-EX100-UHD-T/R3
 BOTH POE SWITCHES SET TO RX (RECEIVING POWER)
 MATRIX HDBASET PORTS SET TO FORCED POE**

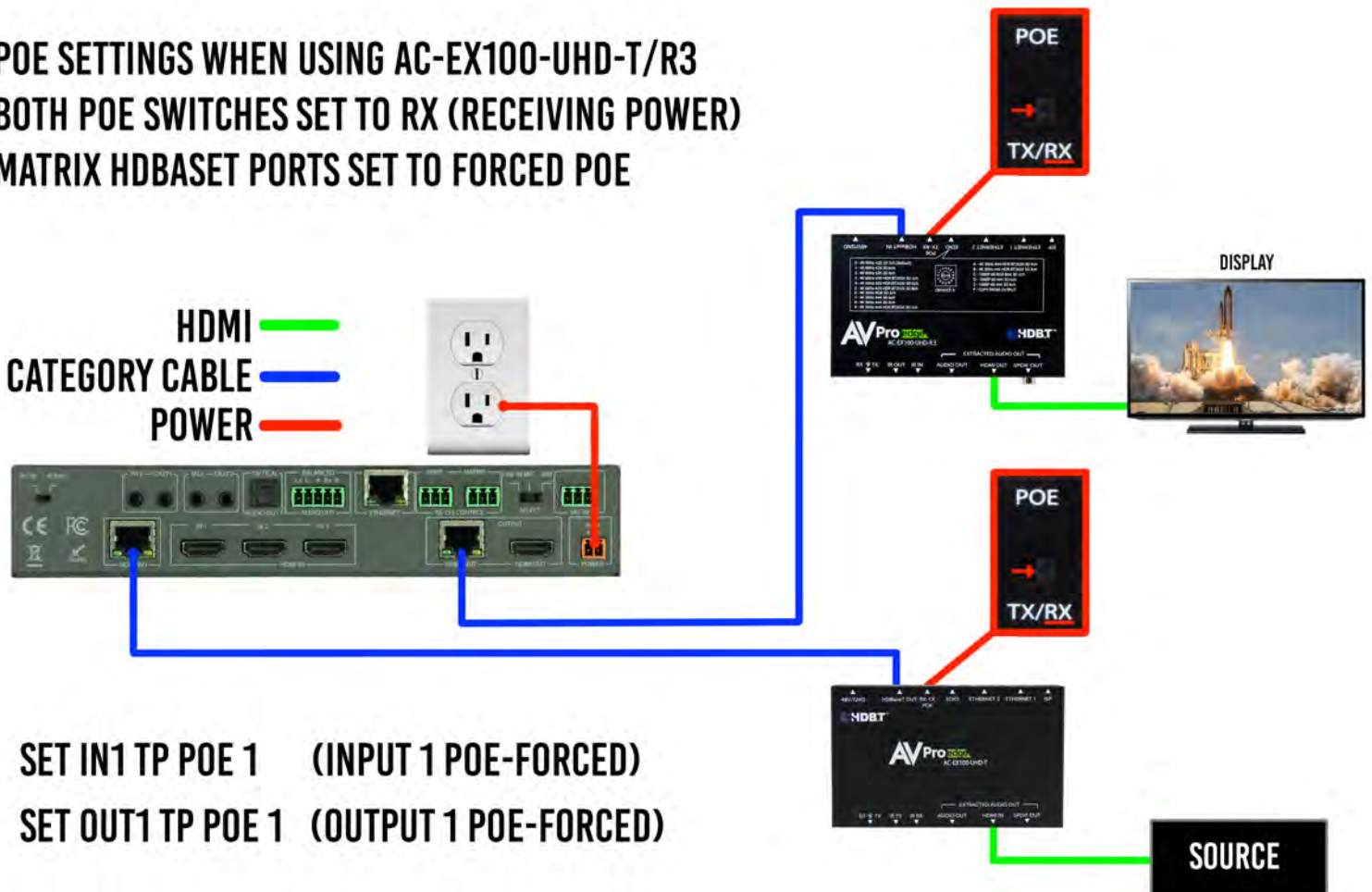

TYPE	RESOLUTION	FRAME RATE (FPS)	COLOUR COMPRESSION	DEEP COLOUR BIT DEPTH	HDR	WIDE COLOR GAMUT (BT2020)	HDMI VERSION	DATA RATE	AUHD SERIES	444 SERIES	UHD SERIES
HD	1920x1080	24	4:2:2	8 BIT	NO	NO	1.4	0.75 GBPS	YES	YES	YES
HD	1920x1080	60	4:2:2	8 BIT	NO	NO	1.4	4.45 GBPS	YES	YES	YES
HD	1920x1080	60	4:4:4	16 BIT	NO	NO	1.4	5.91 GBPS	YES	YES	YES
UHD	3840x2160	24	4:2:0	8 BIT	NO	NO	1.4	8.91 GBPS	YES	YES	YES
UHD	3840x2160	24	4:4:4	8 BIT	NO	NO	1.4	8.91 GBPS	YES	YES	YES
4K	4096x2160	24	4:4:4	8 BIT	NO	NO	1.4	8.91 GBPS	YES	YES	YES
UHD OR 4K	3840x2160	60	4:2:0	8 BIT	NO	NO	1.4/2.0	8.91 GBPS	YES	YES	YES
LINE OF INNOVATION											
UHD OR 4K	3840x2160	24	4:2:0	10 BIT	YES	YES	2.0(A/B)	8.91 GBPS	YES	YES	YES
UHD OR 4K	3840x2160	24	4:2:2	12 BIT	YES	YES	2.0(A/B)	11.14 GBPS	YES	YES	NO
UHD OR 4K	3840x2160	24	4:4:4	10 BIT	YES	YES	2.0(A/B)	11.14 GBPS	YES	YES	NO
UHD OR 4K	3840x2160	24	4:4:4	12 BIT	YES	YES	2.0(A/B)	13.37 GBPS	YES	YES	NO
UHD OR 4K	3840x2160	60	4:2:0	10 BIT	YES	YES	2.0(A/B)	11.14 GBPS	YES	YES	NO
UHD OR 4K	3840x2160	60	4:2:0	12 BIT	YES	YES	2.0(A/B)	13.37 GBPS	YES	YES	NO
UHD OR 4K	3840x2160	60	4:2:2	12 BIT	YES	YES	2.0(A/B)	17.82 GBPS	YES	YES	NO
UHD OR 4K	3840x2160	60	4:4:4	8 BIT	YES	YES	2.0(A/B)	17.82 GBPS	YES	YES	NO

Thank you for choosing AVProEdge!

Please contact us with any questions. We are happy to be of service!



AVProEdge
2222 E 52nd St N ~ Sioux Falls, SD 57104

1-877-886-5112 ~ 605-274-6055
support@avproedge.com