

DomeCam Mini HL user manual

Updated November 12, 2025



DomeCam Mini HL is a wired AI-powered security IP camera with hybrid illumination that enhances image quality at night. In normal night mode, the camera uses IR illumination. When motion is detected, DomeCam Mini HL instantly turns on white light to bring out the object colors. The camera features motion detection and object recognition and allows users to view archived videos and watch live streams. The camera is designed for outdoor and indoor use.

The camera is connected to the system via Ethernet. The recorded videos can be stored on an Ajax [NVR](#) added to the same network, or on a memory card installed in the camera.

The camera is available in several versions:

- DomeCam Mini HL (5 Mp/2.8 mm);

- DomeCam Mini HL (5 Mp/4 mm);
- DomeCam Mini HL (8 Mp/2.8 mm);
- DomeCam Mini HL (8 Mp/4 mm).

Buy DomeCam Mini HL



Camera versions with other enclosures are also available. All Ajax cameras are [available here](#).

Functional elements

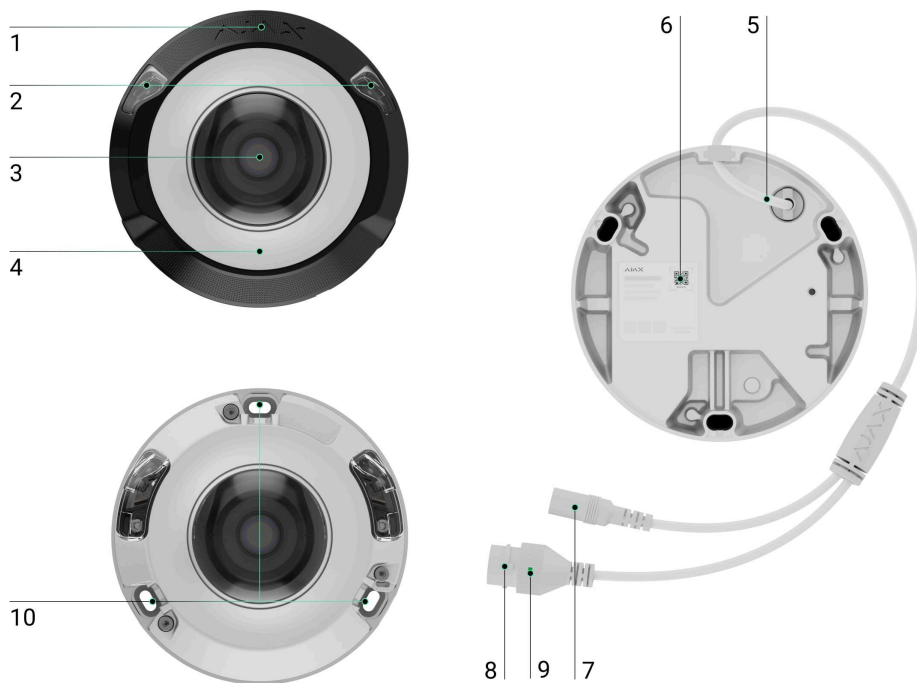



1. Plastic cover.
2. White and IR LEDs. Used to record videos in dark and low-light conditions.
3. Transparent protective lens cover.
4. Camera enclosure.
5. Cable with connectors.
6. QR code with the device ID. Used to add the camera to a space.
7. Power supply connector.
8. Ethernet connector.
9. LED indicator.
10. Holes for attaching the camera to the surface.
11. Screws to secure the camera enclosure. Can be unscrewed with a bundled hexagon key (Ø 2.5 mm).
12. Reset button with an LED indicator.
13. Slot for microSD card.

14. Camera lens enclosure.

15. Screws to secure the camera lens enclosure.

16. Camera lens.

17. Microphone.

Operating principle

DomeCam Mini HL is an IP camera that uses artificial intelligence (AI) for object recognition. Its algorithms can identify moving objects, distinguishing between humans, animals, or vehicles.

The device features hybrid illumination, combining infrared and white light to ensure high-quality images in any lighting conditions. DomeCam Mini HL automatically switches between IR and white light depending on the scene, delivering clear black-and-white images in low light and providing color pictures when motion is detected or additional illumination is required. The camera also adjusts the light intensity in real time to prevent overexposure, ensuring clear visibility of both near and distant objects.



DomeCam Mini HL has an IP65 protection class, making it suitable for outdoor installation. Its robust metal enclosure protects the device against sabotage.

You can install a microSD card with a memory capacity from 32 GB to 256 GB (not included in the complete set of the camera). The memory card should be V30 or faster. Additionally, the device can operate without a memory card or via NVR.



Using the [video storage calculator](#), you can calculate the NVR or camera required storage capacity and estimated recording time based on the video stream settings.

DomeCam Mini HL enables you to:

1. Watch the video in real-time with the ability to zoom in for a closer look.
2. Access archived videos, navigating through them based on recording chronology and calendar (this feature is available if a microSD memory card is installed in the camera, or it is connected to NVR with an installed hard disk).
3. Configure motion detection zones and adjust the sensitivity level.
4. View the **Video wall** that combines images from all connected cameras.
5. Quickly access automation device control from the cameras' video player menu.
6. Create video scenarios that send a short video from the selected camera to the Ajax app when the security detector is triggered.
7. Download the required segments of video recordings from the archive to smartphones or PCs (this feature is available if a microSD memory card is installed in the camera, or it is connected to NVR with an installed hard disk).
8. Configure connection via ONVIF to integrate the device with video management systems (VMS) such as Milestone, Genetec, Axxon, and Digifort.



The video recording segments downloaded from DomeCam Mini HL have the **Ajax digital signature** that verifies the integrity of the exported video. To verify the authenticity of the downloaded video recordings, use the **Ajax Media Player** tool.

[Learn more about Ajax media player](#)

[How to download videos from the archive in Ajax apps](#)

[How to configure temporary camera video access](#)

An admin or PRO with rights to configure the system can set up a connection via ONVIF in [Ajax PRO Desktop](#) and [Ajax Desktop](#) apps.

[How to configure ONVIF authorization](#)

Video scenarios

The Ajax system offers the capability to use IP cameras for alarm verification. Video scenarios enable the substantiation of alarm triggers with the corresponding video from cameras installed at the facility.

Cameras can be configured to respond to alarms from a single device, multiple devices, or all connected devices. Combined detectors can register various types of alarms, allowing you to configure responses to a wide range of alarm types, whether it's just one, several, or all of them.

[Learn more](#)

You can also configure the [sirens](#) to activate when motion or a specific AI-recognised object is detected. When video devices detect motion or a specific AI-recognised object, the system automatically activates sirens added to the hub to sound an alarm.

[Learn more](#)

Video wall

The user can manage videos on the **Video wall**  tab, accessible once at least one camera has been added. This feature ensures quick access to all connected cameras, displayed in accordance with privacy settings.

In mobile Ajax apps, you can:

1. Switch between cameras.

2. Search for the desired camera by name.
3. Manage a PTZ camera.

In Ajax PRO Desktop, you can:

1. Switch between cameras.
2. Search for the desired camera by name.
3. Organize cameras by room, NVR, or group.
4. Manage a PTZ camera.
5. Save customized layouts for displaying video from cameras.
6. Change the order in which the camera video is displayed.
7. Create templates for displaying videos in a slide show.



How to use the video wall widget in Ajax PRO Desktop

What keyboard shortcuts are available in Ajax PRO Desktop

Privacy zones

The system allows hiding parts of the frame. For instance, if a sensitive area or object is in view, activity around it can be recorded without revealing its contents by setting up the right zone. No motion or object will be detected and recorded in the privacy zone.

To do this, in Ajax apps:

1. Go to the **Devices**  tab.
2. Select the camera from the list. Optionally, if the camera is connected to the video recorder, find **NVR**, tap **Cameras**, and select the camera.
3. Go to the device states by tapping the gear icon .



4. Tap the gear icon  again to open **Settings**.
5. Select the **Privacy zones** menu.
6. Open the **Configure privacy zones** menu and select the required area.

0:00 / 0:09

7. Tap on the ✓ icon and return to the camera settings.

The user can create up to four private zones.

Firmware update

If a new firmware version for DomeCam Mini HL is available, the  icon appears in Ajax apps in the **Devices**  tab. An admin or a PRO with access to the system settings can launch an update via device states or settings. The on-screen instructions help to update the firmware successfully.

Selecting the installation site

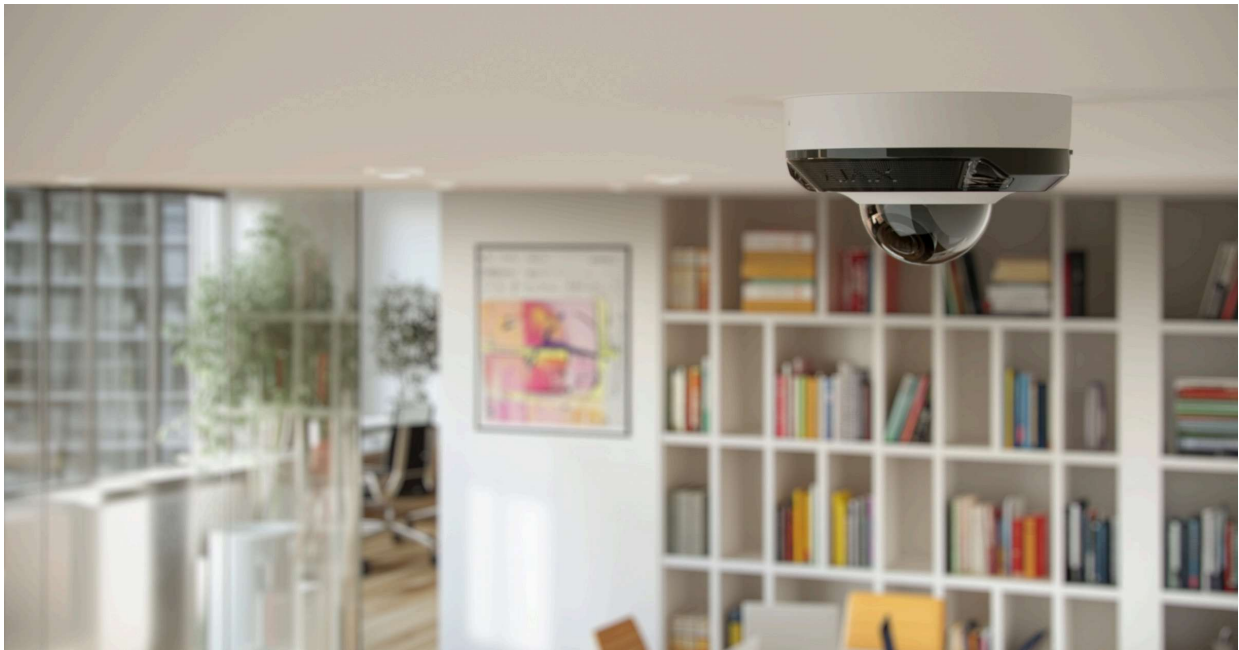

When choosing the optimal location to install DomeCam Mini HL, consider the camera's viewing angle and any potential obstacles that might obstruct its view.

How to install an Ajax camera for better AI recognition

How to install DomeCam cameras

Consider the placement recommendations when designing the security system project for your object. The security system should be designed and installed by professionals. A list of recommended partners is [available here](#).

Where not to install the camera

1. Indoors or outdoors where the temperature and humidity levels do not align with the specified operating parameters.
2. In locations where objects or structures might obstruct the camera's view.
3. In direct bright light or on bright objects (e.g., a white wall), as this can reduce the image quality. The bright surface reflects the IR backlight and blinds the camera in the dark.

Installation



Before installing DomeCam Mini HL, ensure that you have read the camera's operation and maintenance recommendations and have chosen an optimal location that complies with this manual's requirements.

Note that inappropriate installation conditions may result in condensation or device damage.

When connecting an external power supply and using DomeCam Mini HL, follow the general electrical safety regulations for using electrical appliances, as well as the requirements of regulatory legal acts on electrical safety.

To install the device:

1. Connect the Ethernet cable to the camera. If the camera is powered by PoE, no external power supply is required; otherwise, connect both an external power supply and the Ethernet cable.
2. Turn on the camera's power supply. When the network connection is established, the LED indicator on the cable connector will light up green.
3. Add the camera to the system.
4. Disconnect the Ethernet cable and power supply from the camera.
5. Remove the plastic cover.
6. Using the bundled hexagon key (\varnothing 2.5 mm), unscrew the three screws holding the camera enclosure in place. Remove the camera enclosure with the lens protective cover.
7. Insert a microSD card (not included) into the appropriate slot.
8. Using a screwdriver, loosen the two screws holding the camera lens enclosure in place.
9. Adjust the lens position within the camera lens enclosure. Tighten the two screws holding the camera lens enclosure in place.

10. Assemble the camera enclosure and tighten the three screws that hold the camera enclosure in place using the bundled hexagon key (\varnothing 2.5 mm).
11. Using the installation template, mark the drilling points on the surface where you plan to mount the camera. Secure the template to the chosen installation location with tape and drill three holes as indicated on the template.
12. Route the cable and secure the camera to the surface using the bundled screws.



13. Install the plastic cover.
14. Connect the Ethernet cable to the camera. Install a waterproof connector if the camera is used outdoors or indoors where the humidity exceeds the operating parameters.



15. If the camera is not powered via PoE, connect an external power supply to the camera.



The recommended electrical parameters for the external power supply are 12 V= ± 20% with a current of at least 1 A.

16. Turn on the camera's power supply. When the network connection is established, the LED indicator will light up green.
17. Ensure that the camera lens faces the protected area. If necessary, adjust the lens position by removing the camera enclosure and rotating the lens within the lens enclosure.

How to adjust the DomeCam Mini lens position



After adding DomeCam Mini HL to the system, format the memory card in the camera settings.

Adding to the system

Before adding a device

1. Install an Ajax app.
2. Log in to your account or create a new one.
3. Select a space or create a new one.
4. Add at least one virtual room.
5. Ensure the space is disarmed.



Only a PRO or a space admin with the rights to configure the system can add the device to the space.

Types of accounts and their rights

Adding to the space

Adding as a standalone device: Adding to NVR:

1. Open the Ajax app. Select a space to which you want to add the device.
2. Go to the **Devices**  tab and tap **Add device**.
3. Scan the QR code or enter the device ID manually. A QR code with an ID is placed on the device enclosure. Also, it is duplicated on the device packaging.



4. Assign a name to the device.
5. Select a virtual room and a security group (if Group mode is enabled).
6. Tap **Add device** to proceed.

7. Wait for DomeCam Mini HL to establish the connection. Once connected, you will see the live image from the device.

8. Tap **Finish** to add the device.

The connected device will now appear in the list of devices in an Ajax app.

Note that DomeCam Mini HL is compatible with only one space. To connect the device to the new space, remove it from the device list of the old one. This removal process needs to be done manually in an Ajax app.



You can calculate the number of cameras and NVRs that can be added to the space using the [video device calculator](#).

Pairing with an Ajax NVR

If DomeCam Mini HL has already been added to the space as a standalone device, you can easily pair it with an Ajax NVR. If not, refer to the [Adding to the space](#) section to know how to add DomeCam Mini HL to the NVR or as a standalone device.

To pair DomeCam Mini HL with the NVR, in an Ajax app:

1. Go to the **Devices**  tab.
2. Select **NVR** from the list and tap **Cameras**.
3. Tap **Add camera** and wait until the network scan is complete and the available devices connected to the local network are displayed.



Note that DomeCam Mini HL must be connected to the same local network as the NVR.

4. Select the device.
5. Assign a name to the device, select a virtual room and a group, then tap **Finish**.
6. Wait for the system to add the device, then tap **Close**.

The device will now appear in the list of NVR cameras in an Ajax app.

Resetting to the default settings

To reset the camera to the default settings:

1. Turn off the camera by disconnecting the external power supply or Ethernet cable (if it is powered by PoE).
2. Press and hold the reset button.

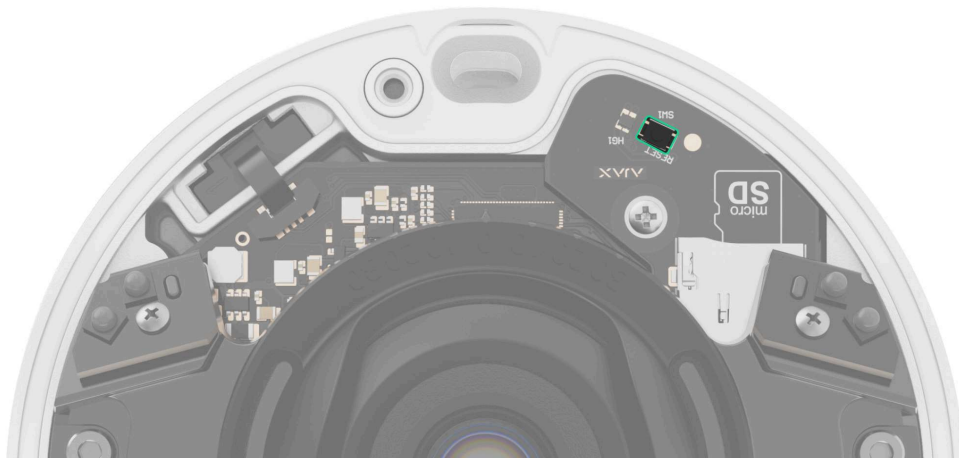

3. Power the camera while the reset button is pressed, and wait until the button's LED indicator lights up violet. This will take about 50 seconds.



The button's LED indicator lights up blue for 20 seconds after powering the camera with a pressed reset button. Then it turns off for 30 seconds and lights up violet. This means that the camera has been restored to the default settings.

4. Release the button.



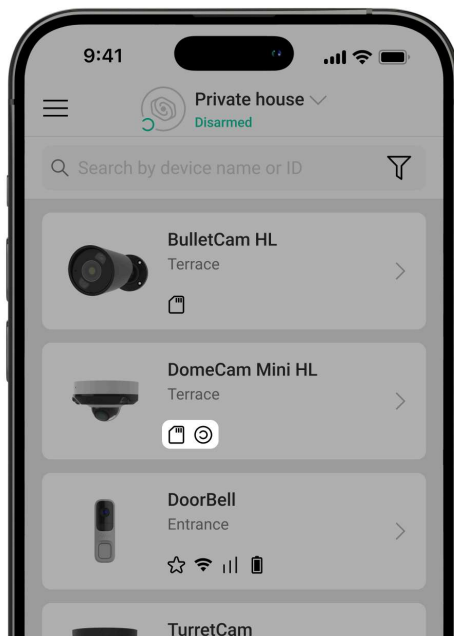





Icons



The icons in the app display some device states. To access them:

1. Select a space in the Ajax app.
2. Go to the **Devices**  tab.
3. Find **DomeCam Mini HL** in the list.



Icon	Meaning
	The extra services are activated according to the subscription. <u>Learn more</u>

	The device operates in Night mode . <u>Learn more</u>
	The microSD card is not installed.
	The microSD card is installed.
	A malfunction of the microSD card is detected. Formatting the microSD card is recommended.
	The microSD card is being formatted.
	The new firmware version is available.
Updating	Firmware update is in progress: downloading/installing the latest version.
	An error was detected during the firmware update.
Offline	The device has lost connection with the Ajax Cloud server.
	The device connection via ONVIF is enabled. <u>Learn more</u>
	There is no access to view the device's video.

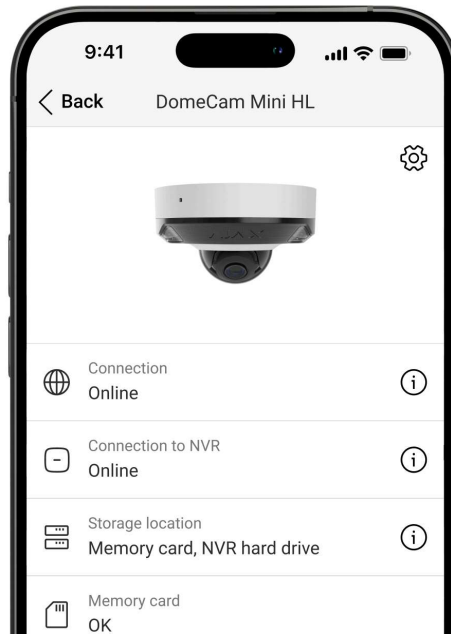
States



The states include information about the device and its operating parameters. You can find DomeCam Mini HL states in Ajax apps:

1. Go to the **Devices**  tab.
2. Select **DomeCam Mini HL** in the list. Optionally, if the camera is connected to the video recorder, find **NVR**, tap **Cameras**, and select **DomeCam Mini HL**.
3. Go to the device states by tapping the gear icon .

Parameter	Meaning
Extra services	<p>The field is available in Ajax PRO apps and displayed when extra services are available or activated for the device according to the subscription.</p> <p>Tapping on the field shows the information about assigned services and contacts of the company providing these services.</p> <p>Learn more</p>

Malfunction	<p>Tapping ⓘ opens the list of device malfunctions.</p> <p>The field is displayed only if a malfunction is detected.</p>
Firmware update	<p>The field is displayed when the firmware update is available:</p> <ul style="list-style-type: none">• New firmware version available – the new firmware is available for download and installation.• Downloading... – firmware downloading is in progress. It is displayed as a percentage.• Installing... – the firmware is being installed.• Failed to update firmware – the new firmware could not be installed. <p>Tapping ⓘ opens more information about the device's firmware update.</p>
Connection	<p>Status of the device internet connection via Ethernet:</p> <ul style="list-style-type: none">• Online – the device is connected to the network. Normal state.• Offline – the device is not connected to the network. Please check your wired internet connection. <p>Tapping ⓘ displays the network parameters.</p>
Connection to NVR	<p>Displayed when the camera is connected to the NVR.</p> <p>Status of the device connection to the NVR:</p>

	<ul style="list-style-type: none"> • Online – the camera is connected to the network via the NVR. Normal state. • Offline – the camera is not connected to the network via the NVR. Please check your wired internet connection. <p>Tapping ⓘ displays the network parameters.</p>
<p>Storage location</p>	<p>Displays the list of storage devices connected to the camera:</p> <ul style="list-style-type: none"> • Memory card – data is recorded on a memory card (not included) installed in the camera. • NVR hard drive – data is recorded on the NVR hard disk. <p>Tapping ⓘ displays the recording mode and storage settings.</p>
<p>Memory card</p>	<p>Status of the memory card connection to the camera:</p> <ul style="list-style-type: none"> • OK – the memory card is communicating with the camera. Normal state. • Error – there is an error in the memory card operation. Check details by tapping the ⓘ icon. Follow the instructions provided in the app. • Not installed – the memory card is not installed in the camera. • Requires formatting – the memory card formatting is recommended. If the memory card contains data, it will be permanently deleted. • Works with errors – the memory card has issues. Press the reset camera button or format the memory card.

	<ul style="list-style-type: none"> • Formatting... – the memory card is being formatted.
Resolution	The current camera resolution.
Frame rate	The current camera frame rate.
Bit rate	The current camera bit rate.
Video codec	<p>The current video codec:</p> <ul style="list-style-type: none"> • H.264 • H.265
Motion detection	<p>The Motion detection feature status:</p> <ul style="list-style-type: none"> • On • Off
Object detection	<p>The Object detection feature settings:</p> <ul style="list-style-type: none"> • Human • Pet • Vehicle • Off
ONVIF integration	<p>Shows the current status of the device's ONVIF integration.</p> <p>This state is displayed only when ONVIF integration is enabled.</p>
Permissions to view	<p>Displays the number of users who have access to view video from the device.</p> <p>Tapping ⓘ displays the list of users, installers, and companies with access under</p>



	<p>certain conditions.</p> <p>The state is not available in Ajax PRO apps.</p>
Uptime	The camera's operating time since the last reboot.
Alarm reaction	
Operating mode	<p>Shows how the device reacts to alarms:</p> <ul style="list-style-type: none"> • Instant alarm – the armed device immediately reacts to a threat and raises the alarm. • Entry/Exit – when a delay is set, the armed device starts the countdown and doesn't raise the alarm even if triggered until the countdown ends. • Follower – the device inherits the delays from Entry/Exit devices. However, when the Follower is triggered individually, it immediately raises the alarm.
Delay when entering	<p>Delay when entering (alarm activation delay) is the time the user has to disarm the security system after entering the premises.</p> <p>Learn more</p>
Delay when leaving	<p>Delay when leaving (arming delay) is the time the user has to leave the premises after arming.</p> <p>Learn more</p>
Arm in Night mode	When this option is enabled, the device will enter the armed mode when the system is set to Night mode .

	<p><u>Learn more</u></p>
Night mode delay when entering	<p>Entry delay time in Night mode. Delay when entering (alarm activation delay) is the time the user has to disarm the security system after entering the premises.</p> <p><u>Learn more</u></p>
Night mode delay when leaving	<p>Exit delay time in Night mode. Delay when leaving (arming delay) is the time the user has to leave the premises after arming.</p> <p><u>Learn more</u></p>
Firmware	Device firmware version.
Device ID	Device ID. It is also available on the QR code on the device enclosure and its package box.

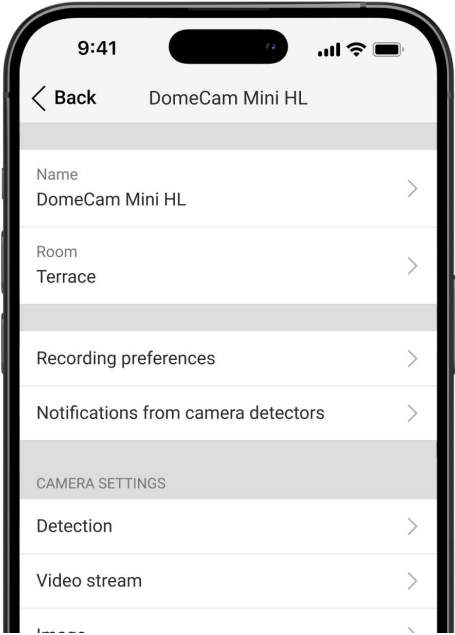
Settings



To change camera settings, in an Ajax app:

1. Go to the **Devices**  tab.
2. Select **DomeCam Mini HL** in the list. Optionally, if the camera is connected to the video recorder, find **NVR**, tap **Cameras**, and select **DomeCam Mini HL**.
3. Go to the device states by tapping the gear icon .
4. Go to **Settings** by tapping the gear icon  again.
5. Set the required parameters.
6. Tap **Back** to save the new settings.

Settings	Meaning
Name	<p>Camera name. Appears in the list of devices, SMS text and notifications in the events feed.</p> <p>To change the device name, tap on the text field.</p> <p>The name can contain up to 12 Cyrillic characters or up to 24 Latin characters.</p>
Room	<p>Selecting the virtual room to which DomeCam Mini HL is assigned.</p> <p>The room name is displayed in the text of SMS and notifications in the events feed.</p>
Recording preferences	<p>Selection of the Recording mode for each storage device:</p> <ul style="list-style-type: none">• On detection or scenario• Continuous• Never

	<p>Selection of the armed mode when the camera records video:</p> <ul style="list-style-type: none">• When armed• Always
Notifications from camera detectors	<p>Opens a menu with Notifications from camera detectors settings.</p> <p><u>Learn more</u></p>
Detection	<p>Opens a menu with Detection settings.</p> <p><u>Learn more</u></p>
Video stream	<p>Opens a menu with Video stream settings.</p> <p><u>Learn more</u></p>
Image	<p>Opens a menu with Image settings.</p> <p><u>Learn more</u></p>
Audio	<p>Settings for audio capture and playback.</p> <ul style="list-style-type: none">• Audio capture and playback – turn on to watch and record videos with audio.• Audio codec.• Bit rate.• Sample rate.• Microphone gain – configure the microphone sensitivity level based on the installation location.

Privacy zones	<p>Allows the user to select zones that are not displayed on the camera video. Instead, the user sees a black rectangle.</p> <p><u>Learn more</u></p>
Alarm reaction	<p>Opens a menu with Alarm reaction settings.</p> <p><u>Learn more</u></p>
Firmware update	<p>Switches the device to the firmware updating mode if a new version is available.</p> <p><u>Learn more</u></p>
Connection	<p>The setting for selecting the camera's connection type to the Ajax Cloud service via Ethernet.</p> <p>Available connection types:</p> <ul style="list-style-type: none">• DHCP• Static
Memory card	<p>Selection of the maximum archive depth. It can be set in the range of 1 to 360 days or can be unlimited.</p> <p>Allows the user to format the memory card.</p>
Service	<p>Opens a menu with Service settings.</p> <p><u>Learn more</u></p>

Monitoring	<div data-bbox="834 163 1403 306" style="border: 1px solid black; border-radius: 10px; padding: 10px; margin-bottom: 10px;">  This setting is available only in <u>Ajax PRO apps</u>. </div> <p>Allows a PRO with rights to configure the system to set up:</p> <ul style="list-style-type: none"> • Zone number for CMS events – unique identifier of the device in events it reports to CMS. • Send events on detections to CMS – whether the device will send notifications on motion or object detection to CMS.
Report a problem	Allows the user to describe a problem and send a report.
User guide	Opens the camera user manual.
Unpair from NVR	<p>Unpairs the device from the NVR to which it was paired.</p> <p>The option is available if the device is paired with the NVR.</p>
Delete device	Erases all device settings and deletes the device from the space. Also, it unpairs the device from the NVR if such connection is set up.

Notifications from camera detectors

Settings	Meaning
----------	---------

Notify if detected	<p>The user can select the type of object or motion, and when it's recognized, a notification is received and sirens are activated:</p> <ul style="list-style-type: none">• Human• Pet• Vehicle• Any motion (by frame analysis) <p>Note that the corresponding types of object or motion should be enabled in the Detection settings.</p> <p>To specify whether motion detection should activate the sirens, tap on the required type of object or motion and enable the Activate sirens upon detection option.</p> <div data-bbox="834 1066 1403 1333" style="border: 1px solid black; border-radius: 10px; padding: 10px;"><p>The feature is available when the camera and at least one siren are added to an Ajax hub with <u>OS Malevich 2.31</u> and later versions.</p></div> <p><u>Learn more</u></p>
When to notify	<p>Selection of the mode when the camera sends notifications:</p> <ul style="list-style-type: none">• When camera armed• Always
Notification delay and interval	

Interval in reporting similar events	<p>Selecting the time interval in reporting similar events: from 30 seconds to 8 hours.</p> <p>The default interval is 3 minutes.</p> <p>Selected time applies for each detection type separately and helps to avoid repeated informing of the same triggering reason.</p>
Duration of object detection for notification	<p>Selecting how long an object should remain in the camera's field of view so the system sends a notification about the detected object. The available values are Notify instantly or 2, 3, 4, or 5 seconds.</p> <p>The default time is 2 seconds.</p>

Detection settings

Settings	Meaning
Motion detection	When the option is enabled, the camera detects motion using its built-in software.
Analyze image	<p>The software algorithm of image analysis that is used for motion detection.</p> <p>The option is available when Motion detection is enabled.</p>
Motion detection settings	<p>Opens a menu with motion detection settings:</p> <ul style="list-style-type: none"> • Adjust activity zone – defines the specific area within the field of view where the camera should detect motion. • Sensitivity threshold – defines the device's sensitivity to the motion in the

	<p>activity zone.</p> <ul style="list-style-type: none">• Area occupied by detectable objects — specifies the size of the area in the camera's field of view that a moving object should occupy for the device to be triggered. <p>The option is available when Motion detection is enabled.</p>
Object detection	<p>When the option is enabled, the camera identifies the type of moving objects using a built-in algorithm. In the video, people, pets, and vehicles are highlighted with colored rectangles.</p>
Object detection settings	<p>Opens the menu with object detection settings:</p> <ul style="list-style-type: none">• Adjust object detection zone — defines the specific area within the field of view where the camera should identify the type of moving objects.• Human detection — enables detection of people in the video.• Pet detection — enables detection of pets in the video.• Vehicle detection — enables detection of vehicles in the video.• Sensitivity threshold — defines the accuracy of the object recognition. The setting is available for each object type. <p>The option is available when Object detection is enabled.</p>

Video stream settings

Settings for mainstream and substream parameters.

Settings	Meaning
Mainstream	
Video codec	Selecting the video compression standard: <ul style="list-style-type: none">• H.264• H.265
Resolution	Selecting the mainstream resolution (depending on the camera model): <ul style="list-style-type: none">• 1024 × 576• 1920 × 1080• 2304 × 1296• 2560 × 1440• 2592 × 1944• 2880 × 1620• 2944 × 1656• 3072 × 1728• 3840 × 2160
Frame rate	Selecting the frame rate: from 3 to 25 with an increment of 1 frame/s.
Bit rate type	Selecting the bit rate type: <ul style="list-style-type: none">• Variable (VBR)

	<ul style="list-style-type: none"> • Constant (CBR)
Bit rate	Setting the bit rate in kbit/s.
GOP length	Selecting the GOP length: from 1 to 250 with an increment of 1 frame.
VBR quality/CBR quality	Selecting the compression quality: from 0 to 100 with an increment of 1.
Substream	
Video codec	<p>Selecting the video compression standard:</p> <ul style="list-style-type: none"> • H.264 • H.265
Resolution	<p>Selecting the substream resolution:</p> <ul style="list-style-type: none"> • 720 × 480 • 720 × 576 • 1024 × 576
Frame rate	Selecting the frame rate: from 3 to 25 with an increment of 1 frame/s.
Bit rate type	<p>Selecting the bit rate type:</p> <ul style="list-style-type: none"> • Variable (VBR) • Constant (CBR)
Bit rate	Setting the bit rate in kbit/s.
GOP length	Selecting the GOP length: from 1 to 250 with an increment of 1 frame.
VBR quality / CBR quality	Selecting the compression quality: from 0 to 100 with an increment of 1.

Image settings

Settings for camera image quality.

Settings	Meaning
Brightness	Adjusting the image brightness.
Color saturation	Adjusting the image color saturation.
Sharpness	Adjusting the image sharpness.
Contrast	Adjusting the image contrast.
Image rotation	<p>Selecting the camera image orientation.</p> <ul style="list-style-type: none">• Default view – the camera image is displayed as captured by the lens without rotation. Use this option if the camera is installed in the standard upright position.• 180° – the camera image is rotated by 180 degrees. Use this option if the camera is installed upside down (e.g., on a ceiling).
Wide dynamic range (WDR)	<p>Enabling or disabling the WDR.</p> <p>When WDR is enabled, it helps to enhance the camera images, with too dark or too bright areas.</p>
Lighting stabilization	<p>Adjusting the exposure:</p> <ul style="list-style-type: none">• 1–2.9 – adjusting WDR levels.• 3–5 – activating and adjusting HDR levels. <p>This setting is available if Wide dynamic range (WDR) is enabled.</p>

<p>Day/Night mode</p>	<p>Selecting the camera vision mode depending on the light conditions:</p> <ul style="list-style-type: none">• Day – IR backlight is always off.• Night – IR backlight is always on.• Auto – IR backlight automatically switches according to the Mode switching conditions settings.
<p>Mode switching conditions</p>	<p>Selecting the conditions for switching between the day and night modes:</p> <ul style="list-style-type: none">• Later to Night / Earlier to Day• Medium• Earlier to Night / Later to Day <p>This setting is available if Day/Night mode is set to Auto.</p>
<p>Scene illumination</p>	<p>Selecting the scene illumination mode:</p> <ul style="list-style-type: none">• Disabled – the camera does not use any built-in illumination. The mode is suitable for well-lit areas or when external lighting is used.• Infrared light – the camera uses IR illumination to capture black-and-white images in low-light conditions. IR light is invisible to the human eye and does not attract attention.• White LED – the camera uses a visible white LED to illuminate the scene. The mode provides color video at night and can deter intruders by attracting attention.• Hybrid light – the camera operates in the Infrared light mode by default. When AI-powered object detection is triggered, the

	<p>white LED turns on to provide color images.</p>
Infrared illumination (IR) mode	<p>Adjusting the intensity of the IR backlight:</p> <ul style="list-style-type: none">• Auto• Custom <p>The setting is used to capture clear black-and-white images at night or in low light and ensures visibility using IR LEDs when conventional lighting is ineffective.</p> <p>This setting is available if Scene illumination is set to Infrared light.</p>
IR intensity	<p>Adjusting the IR light intensity.</p> <p>This setting is available if Infrared illumination (IR) mode is set to Custom.</p>
White LED illumination mode	<p>Adjusting the white LED illumination intensity:</p> <ul style="list-style-type: none">• Auto• Custom <p>The setting is used to capture clear color images at night or in low light and ensures visibility using white LEDs when normal lighting is ineffective.</p> <p>This setting is available if Scene illumination is set to White LED.</p>
Max LED intensity	<p>Adjusting the white LED light intensity.</p> <p>This setting is available if White LED illumination mode is set to Custom.</p>

Set exposure based on	<p>Selecting the frame area on which the exposure is based on:</p> <ul style="list-style-type: none">• Entire frame• Frame's top• Frame's right• Frame's bottom• Frame's left• Frame's center
Exposure mode	<p>Selecting the exposure mode:</p> <ul style="list-style-type: none">• Auto• Manual setup
Image preferences	<p>Adjusting the shutter speed for less motion blur or for less noise in the image.</p> <p>This setting is available if Exposure mode is set to Auto.</p>
Exposure compensation	<p>Ability to override automatic exposure settings to manually control the image brightness.</p> <p>This setting is available if Exposure mode is set to Auto.</p>
Shutter speed	<p>Selecting the shutter speed to ensure correct exposure for the image.</p> <p>This setting is available if Exposure mode is set to Manual setup.</p>
Noise reduction	<p>Enabling or disabling the noise reduction.</p>

Parameter value	<p>Adjusting the noise reduction level.</p> <p>This setting is available if Noise reduction is enabled.</p>
Anti-flicker (Power frequency)	<p>Selecting the power grid frequency to reduce the image flickering. This setting is used if the camera is capturing the video in low-light conditions and lamps are flickering on the camera image with the power grid frequency. Available parameters:</p> <ul style="list-style-type: none"> • 50 Hz • 60 Hz • Disabled – anti-flicker is off.

Alarm reaction settings

Settings	Meaning
Operating mode	<p>Specify how this device will react to alarms:</p> <ul style="list-style-type: none"> • Instant alarm – the armed device immediately reacts to a threat and raises the alarm. • Entry/Exit – when a delay is set, the armed device starts the countdown and doesn't raise the alarm even if triggered until the countdown ends. • Follower – the device inherits the delays from Entry/Exit devices. However, when the Follower is triggered individually, it immediately raises the alarm.

<p>Delay when entering</p>	<p>Selecting delay time when entering: 5 to 255 seconds.</p> <p>Delay when entering (alarm activation delay) is the time the user has to disarm the security system after entering the premises.</p> <p><u>Learn more</u></p>
<p>Delay when leaving</p>	<p>Selecting delay time when leaving: 5 to 255 seconds.</p> <p>Delay when leaving (arming delay) is the time the user has to leave the premises after arming.</p> <p><u>Learn more</u></p>
<p>Arm in Night mode</p>	<p>When enabled, the device switches to the armed mode when the system is set to Night mode.</p> <p><u>Learn more</u></p>
<p>Night mode delay when entering</p>	<p>Delay time when entering in Night mode: 5 to 255 seconds.</p> <p>Delay when entering (alarm activation delay) is the time the user has to disable Night mode after entering the premises.</p> <p><u>Learn more</u></p>

<p>Night mode delay when leaving</p>	<p>Delay time when leaving in Night mode: 5 to 255 seconds.</p> <p>Delay when leaving (arming delay) is the time the user has to leave the premises after enabling Night mode.</p> <p><u>Learn more</u></p>
<p>Night mode delay</p>	<p>Delay time in Night mode: 5 to 255 seconds.</p> <p>It is the time the user has to disable Night mode (alarm activation delay) after the Entry/Exit detector is triggered.</p> <p>The setting is displayed if the device is set to the Follower operating mode and the Arm in Night mode option is enabled.</p> <p><u>Learn more</u></p>

Service settings

Settings	Meaning
<p>Time zone</p>	<p>Time zone selection.</p> <p>Set by the user and is displayed when viewing video from IP cameras.</p>
<p>Connection via ONVIF</p>	<p>Configuring the device's connection via ONVIF to third-party VMSSs.</p> <p><u>Learn more</u></p>
<p style="text-align: center;">Server connection</p>	

Delay of cloud connection loss alarm, sec	<p>The delay helps reduce the risk of a false server connection loss event.</p> <p>The delay can be set in the range of 30 to 600 seconds.</p>
Cloud polling interval, sec	<p>The frequency of polling the Ajax Cloud server is set in the range of 30 to 300 seconds.</p> <p>The shorter the interval, the faster the cloud connection loss will be detected.</p>
Get notified of server connection loss without alarm	<p>When the toggle is enabled, the system notifies users about server connection loss using a standard notification sound instead of a siren alert.</p>

Indication

The green LED indicator is placed on the camera Ethernet connector.

Event	Indication	Note
The network connection is established.	Lights up green.	

Malfunction

When a malfunction is detected, the Ajax app displays a malfunction counter on the device icon. All malfunctions are indicated in the camera States. Fields with malfunctions will be highlighted in red.

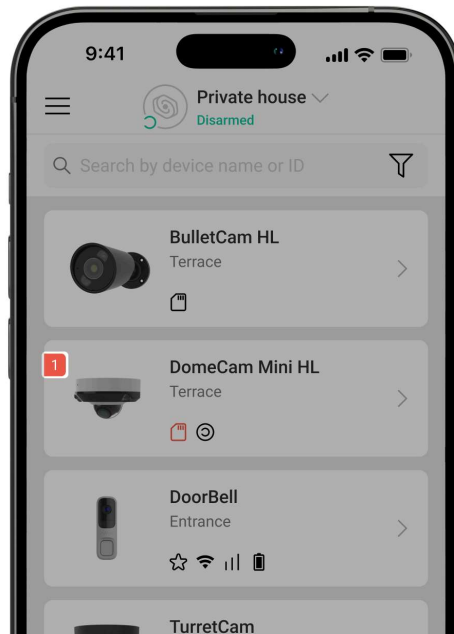

A malfunction is displayed if:

- The camera has lost connection with the server.
- The camera's storage device is malfunctioning. Press the camera's reset button or format the storage device in the camera settings.
- The storage device needs to be formatted. Format the storage device in the camera settings.

Maintenance

Regularly check the functioning of the device. If you notice any image degradation, loss of clarity, or darkening, check the camera for dirt. Clean the device enclosure from dust, cobwebs, and other contaminants as they emerge. Use soft, dry wipes suitable for equipment maintenance.

Do not use substances that contain alcohol, acetone, petrol, or other active solvents to clean the device. Wipe the lens carefully, as scratches can result in poor-quality images and camera failure.

Ensure that the camera is stored and operates in an environment that meets the specified [operating parameters](#).

Preventing the lens from fogging

The camera lens may fog up if its enclosure is disassembled under unsuitable conditions (e.g., when adjusting the lens field of view, installing a microSD card, resetting the camera, etc.).

To prevent the camera lens from fogging:

- Do not disassemble the camera enclosure outdoors in high humidity (e.g., during rain, drizzle, mist, etc.).
- When installing the camera outdoors, avoid sudden changes in ambient temperature and humidity.
- Prevent the camera from any contact with water until installation is complete.
- When assembling the camera enclosure, tighten screws securely to ensure the enclosure is tight.

Ajax cameras contain desiccants inside, but it may take a few days to absorb excess humidity. If the camera lens remains fogged for more than a week, check the enclosure's tightness or contact [Ajax Technical Support](#).

Technical specifications

[Technical specifications for DomeCam Mini HL \(5 Mp/2.8 mm\)](#)

[Technical specifications for DomeCam Mini HL \(5 Mp/4 mm\)](#)

[Technical specifications for DomeCam Mini HL \(8 Mp/2.8 mm\)](#)

Technical specifications for DomeCam Mini HL (8 Mp/4 mm)

Compliance with standards

Warranty

Warranty for the Limited Liability Company “Ajax Systems Manufacturing” products is valid for 2 years after the purchase.

If the device does not operate properly, we recommend contacting Ajax Technical Support first. In most cases, technical issues can be resolved remotely.

Warranty obligations

User Agreement

Contact Technical Support:

- e-mail
- Telegram

Manufactured by “AS Manufacturing” LLC